

SOUND DEVICES



Kashmir™
MICROPHONE PREAMPS

MixPre-6

Audio Recorder | Mixer | USB Audio Interface

User Guide

Legal Notices

Product specifications and features are subject to change without prior notification.

Copyright © 2018 Sound Devices, LLC. All rights reserved.

This product is subject to the terms and conditions of a end-user license agreement provided in this guide, and may be used in accordance with the license agreement.

This document is protected under copyright law. An authorized licensee of this product may reproduce this publication for the licensee's own personal use. This document may not be reproduced or distributed, in whole or in part, for commercial purposes, such as selling copies or providing educational services or support.

This document is supplied as a technical guide. Special care has been taken in preparing the information for publication; however, since product specifications are subject to change, this document might contain omissions and technical or typographical inaccuracies. Sound Devices, LLC does not accept responsibility for any losses due to the user of this guide.

Trademarks

The "wave" logo is a registered trademark and Kashmir is a trademark of Sound Devices, LLC. iPad, iPhone, Mac and OS X are trademarks of Apple Inc., registered in the U.S. and other countries. Windows is a registered trademark of Microsoft Corporation in the U.S. and other countries. Bluetooth Smart is a registered trademark of Bluetooth SIG, Inc. ASIO is a registered trademark of Steinberg Media Technologies. All other trademarks herein are the property of their respective owners.

WEEE Statement



If you wish to discard a Sound Devices product in Europe, contact Sound Devices (Germany) for further information.

MixPre-6 User Guide • Nov 2018

This document is distributed by Sound Devices, LLC in online electronic (PDF) format only. E-published in the USA.

Revision History

This table provides the revision history for this guide.

Rev#	Date	Firmware Version	Description
1-A	April 2017	v1.00	Initial release
1-B	April 2017	v1.00	Fixed some doc errors & added File Transfer information
1-C	April 2017	v1.00	Specs updated
1-D	May 2017	v1.00	Fixed a few doc errors
1-E	May 2017	v1.00	Made more edits in Inputs & USB chapters, Appendix & Specs
1-F	June 2017	v1.11	Fixed USB specs info
1-G	July 2017	v1.11	Corrected errors in Record Menu section (pg 29)
1-H	Oct 2017	v1.20	Edits to several chapters, inc. Inputs & Specs
2-A	July 2018	v2.21	Musician Plugin & misc. updates
3-A	Dec 2018	v3.00	Revised Remote Control chapter w/ info on Wingman for Music projects. Also added new chapters for USB Controllers, and the Ambisonics plugin.

www.sounddevices.com

support@sounddevices.com

Sound Devices, LLC

E7556 Road 23 and 33
Reedsburg, Wisconsin 53959 USA

Direct: +1 (608) 524-0625

Toll Free: (800) 505-0625

Fax: +1 (608) 524-0655

Table of Contents

Intro

Powering

Flexible Powering Options9

Panels

Front Panel11
Left Side Panel11

Right Side Panel12
Back Panel12

Touch Screen

Home Screen13
Main Menu Screen14

Channel Screen15
The Star Button16

Modes and Presets

Setting the Mode17
Basic Mode17
Advanced Mode18

Custom Mode19
User Presets19

Inputs

Channel Inputs21
 Linking Channels22
 Gain Staging with Linking23
Setting Input Delay23
Inverting Phase24

MS Decoder24
Inputs Menu24
 Selecting Input Sources for Ch5 and 6 . . .24
 Configuring Aux In Mode24

Outputs

Stereo Outs27
Headphone Out27

Disabling Record Bells in Headphones . . .28

Metering

LEDs and Meter Views29

Recording and Playback

Formatting SD Cards31
Transport Controls32
Record Menu33
Working with Cue Marks34

Moving Cue Marks35
Previewing Cue Mark Positions35
Clearing & Deleting Cue Points36
Remixing ISOs36

USB

USB Audio Interface39
Low-latency Monitoring40

USB File Transfer40
USB Keyboard41

User Guide

USB-C Mode	41	Adjusting USB Audio Output	41
----------------------	----	--------------------------------------	----

Timecode

Timecode Modes	43	Time of Day (TOD)	44
HDMI TC In.	44	Timecode Frame Rate Auto-Detection	44
Aux In 1, Aux In 2.	44	Timecode Stamp	45

Files and Projects

File Name Format	47	Undo, Trash File	48
Naming a Recording	47	Projects	48
Track Names and Notes	48		

Remote Control

Wingman Application	51	Linear Timecode (LTC) Record Trigger	55
Connecting to a MixPre Recorder	52	Keyboard	56
Music Projects via Wingman	53	USB Keyboard Shortcuts	56
HDMI Record Trigger.	55		

Third-Party USB Controllers

Connecting the MixPre to a Controller.	57	Korg NanoKontrol 2 Interface	60
Map User-Definable Buttons to Shortcuts	58	Korg NanoKontrol Studio Interface	62
Controller Interfaces	58	Novation LaunchControl XL Interface.	63
Akai MidiMix Interface	59		

Musician Plugin

Installing and Activating the Plugin	68	Using Solo/Mute	77
Music Projects	68	Using Reverb	78
Creating a New Music Project	69	Rendering a Vocal Air Effect.	78
Opening an Existing Music Project.	70	Toggling Phase Inversion.	79
Home Screen for Music Projects.	71	Punching In/Out	79
Music Control Menu	72	Working with Cue Points	80
Music Project History	72	Bouncing	81
Track Bank Selector	73	Metronome	83
Channel Screens for Music Projects	75	Record Settings	84
Setting Input Source.	75	Sharing Projects.	84
Enabling Monitoring	76		

MixPre Ambisonics Plugin

Installing and Activating the Plugin	89	Recording	92
Monitoring Ambisonics with Headphones	89		

Appendix A

Basic/Advanced Mode Differences93

System Settings94

Specifications

Audio Inputs95

Audio Outputs96

Recorder96

USB96

Touch Screen96

Timecode97

Remote Control97

Power97

Environmental97

Dimensions and Weight98

Glossary of Terms

Notes100

Software License

FCC & ISED Compliance Statements

Hello and thank you for buying the MixPre-6!

At Sound Devices, we are passionate about audio. We've unleashed our design and engineering team (most of whom are musicians) and let them create a device that we want to own ourselves. We think that you'll find the unique mix of performance, ease-of-use, design and build quality to be an invaluable part of your life and creative passion for many years to come.

The MixPre-6 has been meticulously-engineered to offer extreme flexibility and sound quality, operating in three basic ways:

- 6 mic/line input (4 mic/line XLR/TRS input + 2ch Aux input), 2 channel output mixer with our exclusive Kashmir™ discrete mic preamplifiers with user-selectable analog limiters and low-cut filters.
- SD card recording and playback of individual channels and the main mix simultaneously at 44.1, 48, 96 and 192kHz, 16 and 24-bit files.
- 8-in, 4-out USB computer audio interface

The MixPre's capabilities may be extended further by installing optional plugins such as the Musician plugin or Ambisonics plugin. These are available from the Sound Devices online Plugin Store.

The possible uses for the MixPre-6 are virtually unlimited, but a few common ones might be:

- Paired with a DSLR camera recording high-quality audio for video, complete with timecode and HDMI record triggering.
- Podcast or music recording using up to six high-quality voice-over microphones (or other sources) interfacing via USB to a computer.
- Stand-alone audio recorder for House-of-Worship, mixing a direct feed from the PA system with a stereo feed of ambient congregational response, singing and music from a stereo microphone.

The MixPre-6's application flexibility is augmented by the various powering options. Whether you wish to power the MixPre-6 from a USB connection, AA batteries, L-mount batteries or an optional AC wall plug adapter, it's ready, willing and able to go anywhere, anytime - always handling your audio needs with grace.

We've designed the MixPre-6 to be easy to use for the novice without taking away truly professional-level features for the seasoned pro user. With that in mind, the MixPre-6 ships from the factory in Basic mode - this is ideal for less experienced users and will satisfy the majority of audio applications.

If you want to dive straight into the full array of professional features, we recommend setting to Advanced mode. See *Modes and Presets* for more information.

We sincerely hope that you enjoy working with the MixPre-6 as much as we've enjoyed creating it! Please drop us an email at support@sounddevices.com and share your experiences as we'd love to see how the MixPre-6 is furthering your passion!

Powering

Flexible Powering Options

In designing the MixPre-6, we felt that it was important for it to be able to operate in a wide array of applications and environments. To support that goal, power can be supplied from several possible sources. Some possible powering scenarios are:

- Four AA batteries installed in the provided 4-AA battery sled.
- Eight AA batteries installed in the optional 8-AA battery sled accessory.
- ① *NiMH rechargeable or lithium primary AA batteries are recommended. Alkalines will not power the MixPre for very long due to their higher internal resistance.*
- One or two Sony-type L-mount batteries installed in the optional L-mount battery sled accessory.
- USB-C to USB-C cable connected to a USB-C host computer or AC wall adapter.
- USB-A to USB-C cable connected to a USB-A host computer or AC wall adapter.
- Dual USB-A to USB-C cable (included) connected to a USB-A host computer. Use this cable option if your computer is unable to provide adequate power for the MixPre-6 with only one USB-A port.
- Optional MX-PSU AC wall adapter to USB-C power supply.

The master power switch for the MixPre-6 is located in the upper right corner of the left side panel.

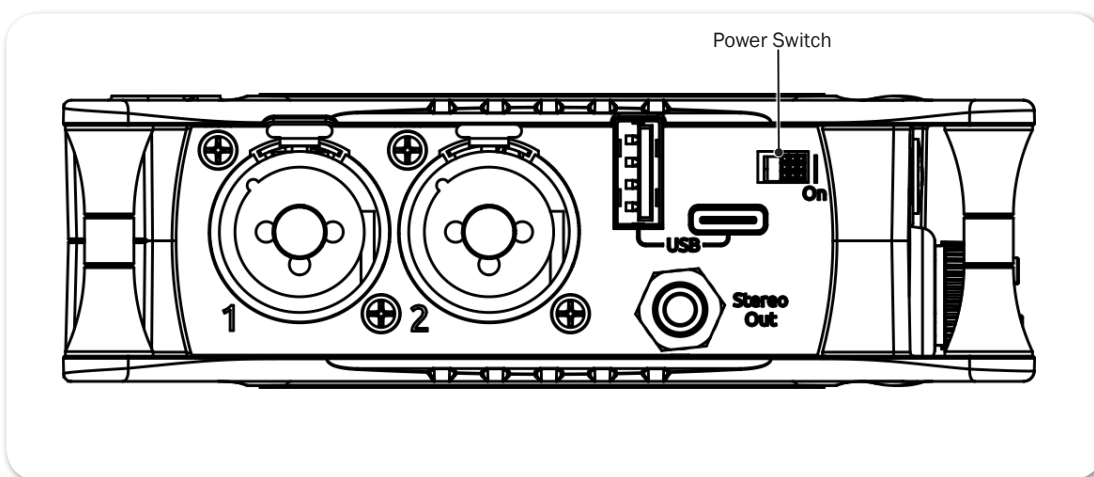

To preserve battery power, USB-C power sources take priority over batteries if both are connected with one exception - if the USB-C power source does not meet the full power requirements of the MixPre-6, you can choose to power from battery or continue to power from USB-C. We have designed the MixPre-6

so that even with an under-powered USB-C source, you will still be able to use two of the four channels with 48V phantom mics. The third and fourth channel can still be used with dynamic mics and line, aux, or USB sources. To achieve this we automatically do the following:

- Dim LCD and LED Brightness
- Disable USB-A port

① *Any devices connected via the USB-A port will be disabled.*

- Disable HDMI TC port

For protection against accidental loss of power (not something you particularly want to happen during recording), the MixPre-6 incorporates circuitry to automatically switch over from USB-C to batteries if the USB-C power source accidentally gets pulled.

Incorrect use of batteries poses a danger of explosion. Replace only with the same or equivalent type. Properly recycle batteries. Do not crush, disassemble, incinerate, dispose in a fire or expose batteries to high temperatures.

Panels

Front Panel

Power light, Recorder transport controls, Star (*) button, Channel knobs, Channel knob ring LEDs, Touch screen

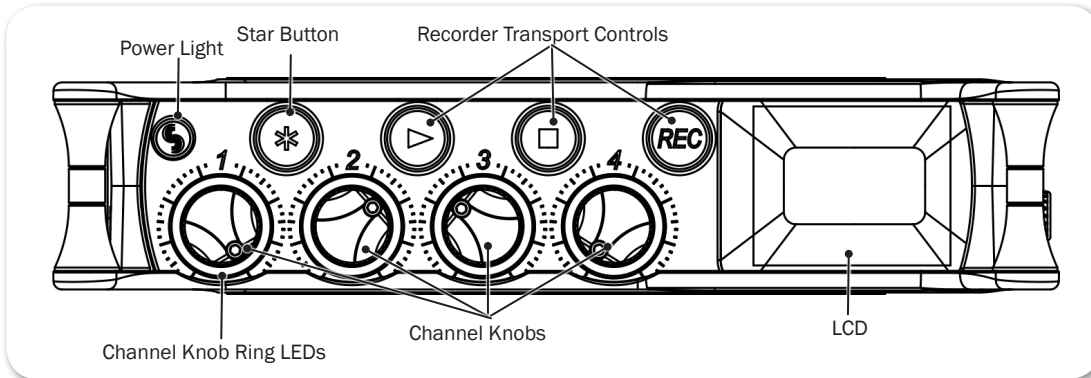

Left Side Panel

USB connections, XLR/1/4-inch TRS inputs 1-2, 3.5mm stereo output, Power switch

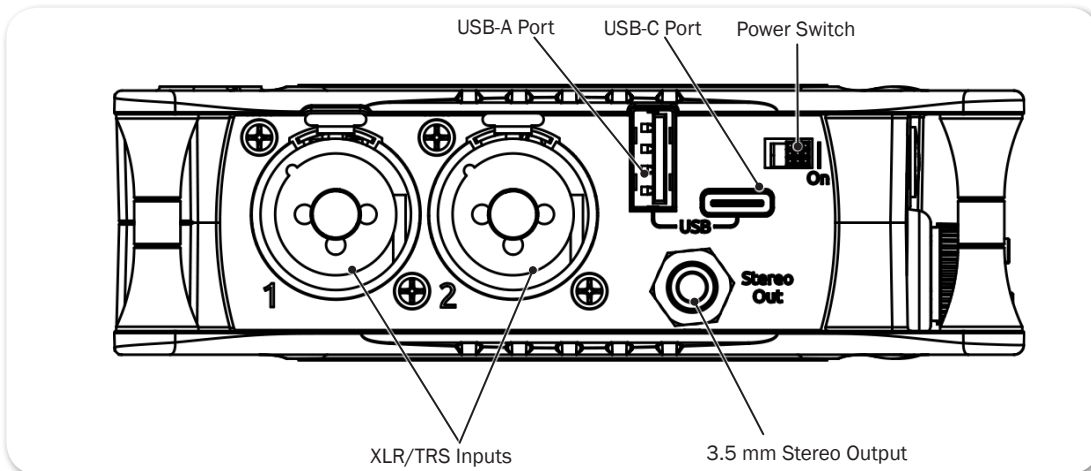

Right Side Panel

3.5mm headphone output, 3.5mm Mic/Aux input, XLR/¼-inch TRS inputs 3-4, Headphone encoder, HDMI TC input

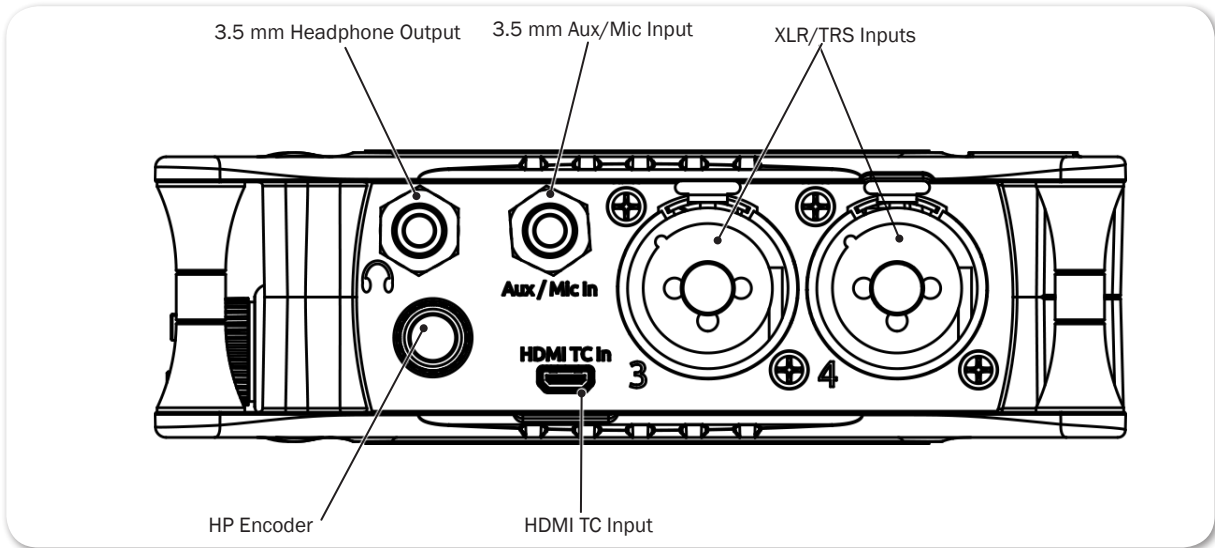

Back Panel

Battery mounts, SD memory card slot, Allen wrench (for ¼-inch-20-thread captive screw), anti-rotational pin

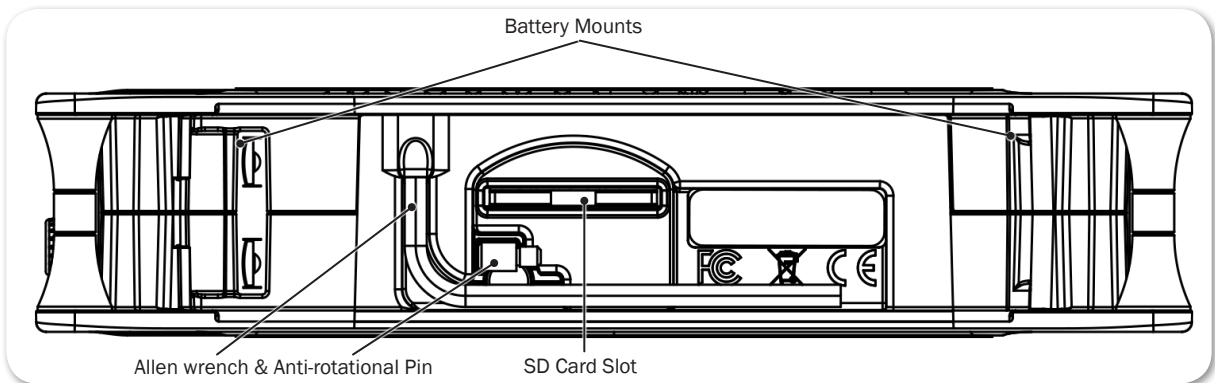

Touch Screen

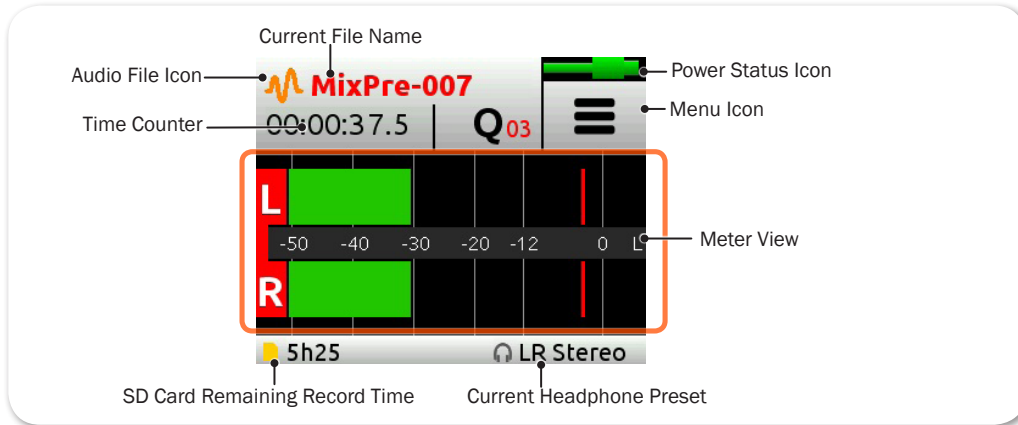

The MixPre-6 has a sunlight-viewable, high-resolution, touch-screen-based user interface. The touch-screen interface consists of the Home screen, Main Menu screen, and Channel screen views. As you will notice, there are several touch zones on the touch screen for controls. As you become familiar with the user interface, changing settings for inputs, outputs, recording and metering will become fast and intuitive.



Home Screen

The Home screen view is the default view that appears on the touch screen when the device is powered up. On it, you will find items such as:

- File list icon and current file name
- File elapsed time counter (timecode if LTC or HDMI timecode is enabled)
- Power status icon

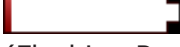
POWER STATUS ICON	DESCRIPTION
 (Green USB)	USB power source is ideal.
 (Orange USB)	USB power source low. Brightness dimmed, HDMI & USB-A ports disabled, 48v phantom on 2 channels only.
 (Green Battery)	Healthy battery. Plan to change batteries when green level drops to about ¼ full.
 (Flashing Red Battery)	Battery power is critically low. Change batteries.

- Q icon - Indicates current cue number: 01, 02, etc. Tap to set cue markers.
- Menu icon
- Meter view (cycle views by touching)
 - Two channel mix track meters
 - Two channel mix track meters, six individual track view
 - Two channel mix track meters, two USB input meters, two aux input (camera) meters

- Status bar
 - SD card available recording time
 - Headphone preset
 - Sample rate and bit depth
 - Date and time

Main Menu Screen

The Menu screen is where most of the features and functions are selected and set up.

To enter the Menu screen:

- ▶ Tap  on the Home screen.

There are three Menu screen views. These views are indicated by the Dots icon . Tapping it will toggle between the three Menu views.

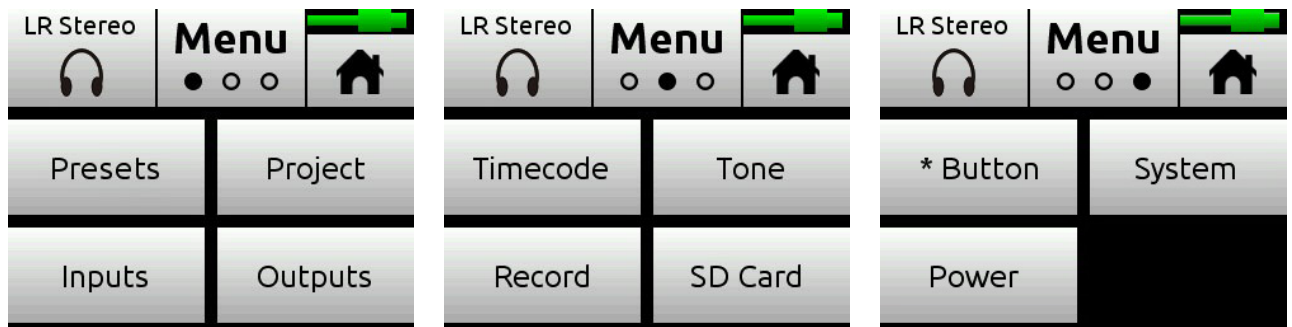

The Menu has its own submenus that may be displayed by tapping them.

To return to the main Menu from a submenu at any time:

- ▶ Tap .

To return directly to the Home screen from the main Menu:

- ▶ Tap .

PAGE	SUB-MENU	DESCRIPTION
1	Presets	Lets you save and recall preset user settings to and from SD cards and internal memory. Also allows resetting all settings to factory default.
1	Project	Provides the ability to create new, open and trash existing projects.
1	Inputs	Provides settings for the Aux/Plug-in-power Mic/Timecode input/Camera, as well as access to Channel screens for channels 5 and 6.
1	Outputs*	Provides routing and gain settings for the stereo output.
2	Timecode*	Lets you select timecode mode.
2	Tone	Provides test tone settings.
2	Record**	Provides record settings for LR mix gain, sample rate, bit depth, pre-roll time, HDMI record trigger, remix, and record bells.
2	SD Card	Displays current SD card information and allows for format and empty trash card functions.
3	* Button	Assigns various functions as shortcuts to the * button on the front panel.
3	System	Provides settings for Basic/Advanced/Custom mode, Custom mode setup, limiters, USB-C, File Transfer, Bluetooth®, Wingman App password, adjusting LCD/LED brightness, date and time, updating firmware, and viewing version and regulatory information.
3	Power	Select the type of batteries being used (Alkaline, NiMH, L-Mount) to ensure that the Power Status icon on the Home screen accurately displays remaining battery level.

* Sub-menu/setting appears in Advanced mode only
 ** Some Record sub-menu options are only available in Advanced mode

Channel Screen

The Channel screen is where you will find channel-specific settings, such as Channel name, Input selection, Pan, 48V phantom power and Low Cut filtering.



In Advanced mode, additional settings are available via a second channel page accessed by tapping the Dots icon.

- ① *The top left corner of the Channel screen displays an editable Channel name. Touch this region to give the channel an easy to identify name, like Vocals or Bob. Below the Channel name is a Channel meter to aid in setting audio levels.*

PAGE	SUB-MENU	DESCRIPTION
1	Solo*	Lets you solo the selected channel in the headphone output. Soloing by default is Individual (exclusive) in that only one input at a time will be soloed. When a channel is soloed, its light ring will flash orange. Soloing can be set to Multiple (non-exclusive) in the HP Preset submenu.
1	Mute*	Lets you mute the selected channel.
1	Arm*	Allows pre-fade recording of the channel to its own isolated (ISO) track on the SD card.
1	Gain*	Sets the sensitivity of the input. Generally, the gain should be set so that the loudest parts of the audio signal just touch the red segments of the meters.
1	Pan	Lets you position the channel's audio in the stereo image of the LR mix and stereo out.
1	Low Cut	Sometimes referred to as a high pass filter (HPF), the Low Cut filter can be set up to roll off bass frequencies or reduce mic handling noise, wind noise, and other undesirable low frequencies. The filter has a carefully crafted 18 dB/octave slope.
2	Input	Lets you select one of the available Mic, Line, or USB inputs to route to the chosen channel.
2	Phantom	Lets you apply full 48v phantom power to the channel's mic or line input.
2	Phase*	Allows the signal's polarity to be inverted 180 degrees.
2	Delay*	Inserts an adjustable delay in the signal path. Often used for phase alignment of multiple mics or lip synchronization for video.
2	Linking*	Lets you link channels 1 and 2, and 3 and 4 either as a stereo pair or mid-side pair. Channels 5 and 6 may be linked as a stereo pair. You can also link channels 1-3 and 1-4. When 3 or more channels are linked, you can also select Link Type for how levels are controlled via channel 1 knob. Options include: All or Faders only.

* Sub-menu/setting appears in Advanced mode only

To enter the Channel screen:

- ▶ Press the associated Channel knob.

① *You can access Channel screens for channels 5 and 6 via sub-menu options in Menu > Inputs, or by using the Star (*) button, when Menu > * Button is set to Ch 5/6 Screen Toggle.*

The Star Button

The MixPre-6 has a user-programmable button, called the Star (*) button, for flexible customization. You may configure it to gain quick access to certain features.

To set the Star button functionality:

- ▶ Tap  and set * Button to any of the available options, which include toggling between Channel 5 & 6 screens, the Project sub-menu, the Solo/Mute screen, the SD Card screen, or the Undo function.

Modes and Presets

Setting the Mode

We've designed the MixPre-6 to be easy to use for the novice without taking away truly professional-level features for the seasoned pro user. We want both the newcomer and the career professional to enjoy a quick, easy setup and foolproof results. To accommodate this, we've incorporated three modes of operation into the MixPre-6: Basic, Advanced, and Custom.

To set the mode:

1. Turn all channel knobs to Off (at full counter-clockwise position).
2. Tap .
3. Tap System > Mode. Options include: Basic, Advanced, and Custom.

Basic Mode

Basic mode is intended for hassle-free, plug-and-play use. This mode is ideal for the new user and amateur needing only the basic functionality of the MixPre-6.

SCREEN	SUB-MENU	DESCRIPTION
Menu	Presets	Save and load user presets to and from SD card and internal memory. Also allows resetting all settings to factory default.
Menu	Project	Create new projects, or open and trash existing projects.
Menu	Inputs	Provides settings for the 3.5 mm Aux/Mic In, as well as access to the Channel screen for channels 5 and 6.
Menu	Timecode	Select Time of Day or HDMI TC from a DSLR as timecode source. Off is also an option.
Menu	Tone	Turn the test tone on or off. By default, the test tone is a 1kHz sine wave at -20dBFS.
Menu	Record	Choose to auto start/stop recording via HDMI from a DSLR, set pre-roll time, and turn on/off record bells.
Menu	SD Card	Displays SD card info and allows for formatting SD cards and emptying their trash folder.
Menu	System	Provides settings for Basic/Advanced/Custom mode, Custom mode setup, limiters, USB-C, File Transfer, Bluetooth®, Wingman App password, adjusting LCD/LED brightness, date and time, updating firmware, and viewing version and regulatory information.
Menu	Power	Select the type of batteries being used (Alkaline, NiMH, L-Mount) to ensure that the Power Status icon on the Home screen accurately displays remaining battery level.
Menu	HP Preset	Select LR Stereo or USB 1,2 or USB 3,4 as headphone sources.

SCREEN	SUB-MENU	DESCRIPTION
Channel	Pan	Pan the channel's signal Left, Center or Right in the stereo LR mix and Stereo Out.
Channel	Input	Select one of the available Mic, Line, Aux (only available when Aux In Mode is Mic or Line) or USB inputs to route to the selected channel.
Channel	Phantom	Turn on 48V phantom power when using a condenser microphone in the selected channel.
Channel	Low Cut	Select the frequency at which a low cut filter will be placed. The filter has a carefully-crafted 18db/octave slope. Low Cut options are only On/Off in Basic mode.

Advanced Mode

Advanced mode is intended for use by professionals and users who wish to have every available setting and option at their disposal. All settings available to Basic Mode apply to Advanced Mode in addition to:

SCREEN	SUB-MENU	DESCRIPTION
Menu	Outputs	Provides routing and gain settings for the Stereo Out.
Menu	Tone	Provides additional Tone mode (Continuous and Left Identify) and Tone Level settings.
Menu	Record	Provides additional record settings for gain, sample rate, bit depth and LR linking.
Menu	HP Preset	Provides additional HP presets for LR Mono, User Presets 1-4, Edit HP Preset utility and HP Solo mode selection. Camera Stereo and Camera Mono are also available when Aux In Mode is set to Camera.
Menu	System > Limiters	Lets you turn limiters on or off.
Channel	Solo	Lets you "solo" the selected channel in the headphone output. Solo mode can be set to Individual or Multiple in the HP Preset menu. When a channel is soloed, its light ring will flash orange.
Channel	Mute	Lets you "mute" the selected channel. When a channel is muted, its light ring will illuminate red.
Channel	Arm	Allows pre-fade recording of the channel to an individual track on the SD card.
Channel	Gain	Sets the sensitivity of the input. Generally, the Gain should be set so that the loudest parts of the audio signal just touch the red segments of the meters.
Channel	Pan	Lets you position the audio of the channel anywhere between Left and Right in the stereo image of the LR mix and Stereo Out.
Channel	Linking	Lets you link channels 1 and 2, and 3 and 4 either as a stereo pair, mid side pair, or turn linking off. Channels 5 and 6 can also be linked as a stereo pair, and channels 1-3 or 1-4 may be linked.
Channel	Phase	Lets you set polarity to either Normal or Inverse.
Channel	Delay	Sets the delay from 0 to 30 ms in 1 ms increments.

Custom Mode

Custom mode is intended for users who want to customize the features and functionality available to them. This mode grants access to different sections of Advanced Mode features, turning them on or off in the user interface as desired.

To configure Custom Setup:

1. Tap .
2. Tap System > Mode, and then select Custom.
3. Tap System > Custom Setup to customize what features you want to access.

Custom Setup options are:

PAGE	SUB-MENU	DESCRIPTION
1	Channel	Lets you access Solo, Track Arm, extended Pan, Input Select, Phantom, Phase, delay, and Low Cut, which is selectable by frequency.
1	Gain	Lets you access to (two-stage) Channel Gain controls, limiters and linking.
1	Headphone	Lets you access extended headphone source select options including factory and user headphone presets, preset editing and Solo setup for Individual/Multiple channels.
1	Record	Provides additional record settings for gain, sample rate, bit depth and LR arming/linking, as well as ISO track arming/naming.
2	Metadata	Adds ability to change track name, rename files, add notes and undo recordings.
2	Outputs	Provides routing and gain settings for the Stereo Out, as well as Tone mode and level.

User Presets

Flexibility is the MixPre-6’s M.O. To make it easy for you to use the MixPre-6 in a wide variety of situations, we created a slick feature where you can store and recall snapshots of all of the MixPre-6’s settings. There are four internal Preset slots available. Also, the SD card can store virtually unlimited Presets.

Here are three common examples:

- You might want to use the MixPre-6 as recorder, mixer, and USB audio interface in a podcasting rig with specific microphones.
- The next day, you need to have the MixPre-6 handle audio duties for you while you’re shooting video on your DSLR camera.
- On Sunday, you might need to use your trusty MixPre-6 to record worship services, mixing a direct line from the PA with a stereo microphone feed.

Using Presets, you can optimize settings for each of these scenarios and then simply save each setup to one of four internal preset locations or to the SD

card. Once saved, simply load the appropriate preset and BOOM! You're ready to go in a jiffy! We think that you'll really appreciate this functionality.

To save a Preset:

1. Tap .
2. Tap Presets > Save to Internal 1-4 or SD Card
3. Enter a Preset Name and tap OK.

To recall a Preset

1. Tap .
2. Tap Presets > Load Preset.
3. Select preset with encoder.
4. Tap OK.

Inputs

The MixPre-6's flexibility is enhanced by its ability to select various input types to its mixer channels. Each of the MixPre-6's channels can be sourced from an XLR mic/line input, 3.5mm Aux or PiP (Plug in Power) Mic input or from either of the two USB audio paths from a computer.

Channel Inputs

BASIC MODE -

For quick and easy applications, access the channel's input settings by pushing the channel's channel knob. You will see the Channel screen displayed.

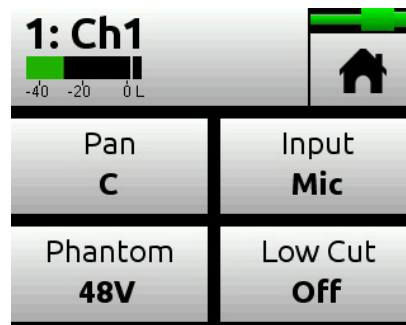

There, you'll be able to select the channel input source, whether you'd like to send the audio to the Left, Center or Right in the mix bus and Stereo Out, select Phantom power (for condenser microphones and active DIs), and select a Low Cut filter. The MixPre-6's Kashmir mic preamplifiers have extreme dynamic range and noise specs as well as analog limiters so it's not necessary for you to set any levels other than that of the Channel knob (which sends the audio to the LR mix record channels and the Stereo Out). The limiters are present on each channel and the LR mix bus. This means that peaks that would normally clip other mic preamplifiers and ruin a mix, will be handled in just the right way to make sure that your audio is safe from accidental clipping both on the Stereo Outs and the recorder.

ADVANCED MODE -

Advanced mode is for more complex situations requiring individual channel-to-track recording, soloing, channel linking and extended gain functionality and limiter bypass.

The Channel screen appears differently—with more pages of settings—in Advanced mode.



To set up channels:

1. Press the rotary knob for the chosen channel.
2. Tap Input and select from the following input types:

INPUT TYPES	DESCRIPTION
Mic	Use for microphones. For condenser mics requiring 48v phantom power, set Phantom to On.
Line	Use this type for balanced analog line level sources.
Aux In 1-2	Use for unbalanced stereo input.
USB 1-4	Use for external audio from a computer.
Off	Turn the input off.

3. Tap Low Cut to set low-cut filter levels—ideal for reducing wind or mic handling noise.
4. Tap Pan to adjust the input's pan in the mix bus and Stereo Out.

Linking Channels

Are you working with a stereo source—a keyboard or stereo mic perhaps? To make it easy to adjust these types of sources, the MixPre-6 offers linking of channel pairs 1-2, 3-4, and 5-6.

For example, the following procedure links channels 1 and 2.

To link channel pair 1-2:

1. Push the Channel 1 knob to access that channel's screen.
2. On page 2, tap Linking.
3. Do one of the following:
 - ▶ Select 1-2 for a stereo source.
 - ▶ Select 1-2ms for MS (Mid-Side) source.

You'll now be able to control the level of both channels 1 and 2 with the Channel 1 knob. The Channel 2 knob will now function as a balance control if stereo linked or as a width control if MS linked.

The MixPre-6 also offers multichannel linking for channels 1-3 and 1-4.

To link multichannels:

1. Ensure System > Mode is set to Advanced, or if using Custom mode, that Channel is set to Advanced.
2. Push the Channel 1 knob to access that channel's screen.
3. On page 2, tap Linking and select 1-3 or 1-4.

When multiple channels are linked, gain, fader, limiters, track arming, low cut filters, and input delay are all linked and controlled from the Channel 1 screen and knob.

Additionally, the Link Type menu provides the ability to choose which parameters are linked when linking three or more channels.

- Selecting the All option links input type, trim gains, faders, limiters, low cuts, record arms, and delays.
- Selecting the Faders Only option links only the faders.

Gain Staging with Linking

In Custom setups, the Linking feature is found in Custom Setup > Channel > Advanced, which lets you link inputs while still having the option of one or two gain stages.

Users wanting to link inputs, but control all levels from the front-panel Channel 1 knob should set System > Mode to Custom and then in Custom Setup, set Gain to Basic and Channel to Advanced.

Users wanting to link inputs with two gain stages while in Custom mode, ensure that Gain and Channel are both set to Advanced. Then, you can adjust gain levels for linked channels from the Channel 1 screen and adjust fader levels for linked channels with the Channel 1 knob.

Setting Input Delay

Input delay may be used to compensate for 'phasey' sounding audio because of time-of-arrival differences between sound sources, such as a boom mic and wireless radio mic picking up the same sound source.

To set a channel's input delay:

1. Push in the channel's knob to access its Channel screen.
2. On page 2, tap Delay.
3. Tap the arrows or use the encoder to adjust the setting. Each channel can be delayed up to 30ms.

The delay is applied before the signal is sent to the recorder and outputs.

① *Input Delay is not available in Basic mode.*

Inverting Phase

Phase inversion (or polarity reversal) is used to compensate for incorrectly wired, balanced cables, to prevent signal cancellation when a source is dual-mic'd from opposite directions, or to reverse left/right with microphones in a mid-side (MS) configuration.

To invert a channel's phase:

1. Push in the channel's knob to access its Channel screen.
2. On page 2, tap Phase to set it to Invert.

① *Phase Inversion is not available in Basic mode.*

MS Decoder

You can choose to have the MS decoder apply to the mix only and not isolated tracks.

To set MS Decode:

1. Tap .
2. Tap Inputs > MS Decode. Options include: ISO & Mix or Mix Only.

Inputs Menu

The Inputs menu allows you to access Channel 5 and 6 screens, and the Aux In Mode settings, which lets you configure how the Aux/Mic In 3.5mm connector is used.

Selecting Input Sources for Channels 5 and 6

Similar to Channel screens for 1-4, input sources for channels 5 and 6 may be selected from their screens.

Options are:

- **Channel 5:** Aux In 1, USB 1 or Off
- **Channel 6:** Aux In 2, USB 2 or Off

① *From these screens, you may also solo, arm tracks, adjust gain, pan, low cut, and set linking.*

Configuring Aux In Mode

Configure the Aux/Mic In connector from the Inputs menu, by tapping Aux In Mode and selecting one of the following options:

- **Mic:** Select this option when the Aux/Mic In is to be used with a plug-in-

power mic.

- **Line:** Select this option when the Aux/Mic In is to be used with an unbalanced 2ch line source, such as smartphone headphone output, stereo line source, etc.

When either the Mic or Line options above are selected as the Aux In Mode, they are available as input sources to any channel by selecting Aux In 1 or Aux In 2.

- **Camera:** Select this option when the Aux/Mic In is to be used for monitoring a video camera's audio output via the MixPre-6's headphones and C1/C2 meters located on meter view 3.

This is particularly useful when you want to use the MixPre-6 to drastically improve the sound quality recorded on the DSLR camera. It is common knowledge that DSLR mic inputs are of poor quality so by connecting your mics to the MixPre-6 instead, then connecting the MixPre-6's stereo output to your camera audio input, you will achieve far superior sound quality. Then by connecting the camera's audio output to the MixPre-6's Aux/Mic In, it allows you to check that the camera audio is noise and distortion-free.

When this option is selected an additional setting appears in the Input Menu called Camera Gain. This allows you to adjust the gain of the incoming camera audio level.

You also gain camera monitoring options in the HP Presets menu.

- **Timecode** (only available in Advanced Mode): Select this option when the Aux/Mic In is to be used as a LTC (linear timecode) input. When selected as a timecode input, Aux In 1 and Aux In 2 become available as options for TC Mode (located in Timecode Menu)

① *When Aux In Mode is set to Camera or Timecode, you cannot route Aux In to a channel and thus you cannot record it.*

- **Off:** Select this option to turn off the Aux/Mic Input.

Outputs

While we were carefully thinking about how to maximize flexibility with the inputs, we were doing the same with the outputs!

Stereo Outs

The Outputs menu is available in Advanced mode and accessed through the Main Menu. In the Outputs menu, you may send any channel, aux input, USB input or LR mix to either or both of the Stereo Outs. In addition, if you choose to send the channels to outputs, you can select either pre-fade (channel knob has no effect) or post-fade (channel knob controls level). In addition to routing options, the Outputs sub-menu also provides gain adjustment of the Stereo Outs. Range is; Off, -40 to +20dB.

Output Muting

On the MixPre-6, the 3.5mm stereo output may be muted.

To mute outputs:

1. Tap .
2. Tap Outputs.
3. Tap St Out Mute.

This toggles Mute on/off.

 *The Output Mute feature may also be set as a * Shortcut.*

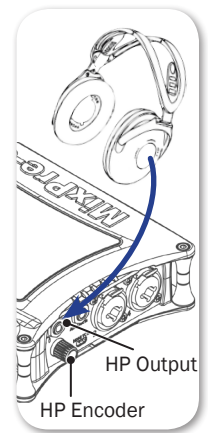

Headphone Out

The MixPre-6's audiophile-grade headphone amplifier provides high power and very low noise performance so that you can accurately hear the audio being handled, regardless of headphones or environment.

To connect headphones:

- ▶ Plug in the headphones cable to the 3.5mm jack located on the right side panel.

The volume of the headphones can be set with the encoder directly adjacent to the headphone jack.

- ① *When clipping occurs in the headphones, the Headphone Clip indicator appears in the top right corner of screen, over the Power Status indicator.*



From the main Menu screen, the headphone presets (HP Presets) may be accessed by pressing this icon in the upper left corner of the screen. Above this icon, the currently selected HP preset is displayed.

Entering the HP Presets menu, you may select from LR Stereo, LR Mono, USB 1,2, USB 3,4 and User Presets 1-4.



- ① *Options listed here are those available in Advanced mode. Only LR Stereo, USB 1,2, and USB 3,4 are available in Basic mode.*

There's an Edit HP Preset utility where User HP presets may be edited and given custom names and finally a "HP Solo" button where the HP solo mode can be switched between Individual and Multiple for single or multi-channel solo monitoring.

Since the headphone amplifier is capable of very high output levels, please use caution when wearing headphones as hearing damage could result with inappropriate volume levels.

Combining the input/output flexibility and the User Presets feature, you will find endless uses for the MixPre-6!

Disabling Record Bells in Headphones

Record bells, heard in headphones when recording is started and stopped in Audio projects, may be turned off.

To disable the record bells:

1. Tap .
2. Tap Record > Record Bells.

This toggles the bells on/off. They are turned on by default.

Metering

LEDs and Meter Views

There are five basic methods for observing input and output meters on the MixPre-6.

- Channel knob ring LEDs - Each LED ring is capable of displaying green, orange and red colors. The brightness of the light ring tracks the level of the input. Green = signal present, red = signal peaking, orange = signal limiting. In addition, a channel's ring LED will flash orange when in solo.

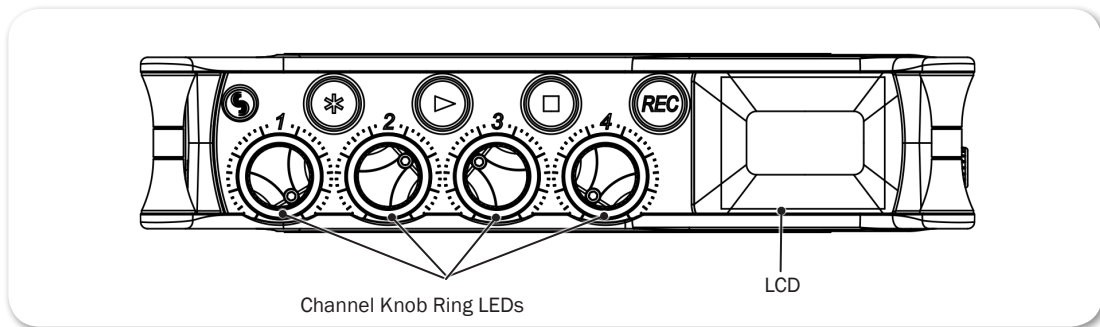

- Channel screen meter



- Main LR stereo meter view

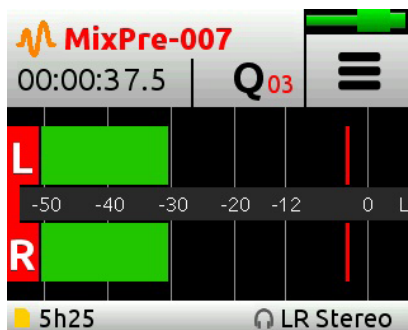

- LR, 1-6 multi-track meter view

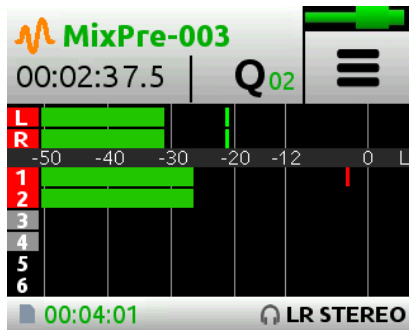

- LR, Camera Returns (via Aux In) and USB 1,2 meter view



Switching between the three main meter views is easy—just touch the meters and cycle through the different views. The meters will show not only signal levels, but also the current arm status of each track for the recorder and limiting activity for L,R and each channel.



Recording and Playback

The MixPre-6 can record up to eight audio tracks at 192 kHz, 24-bit to SD cards (SD, SDHC, or SDXC) using the industry standard .WAV file format. The recorded .WAV files written to SD card can be imported or played back using any MAC, Windows, or Linux computer installed with a compatible audio application, such as Pro Tools, Reaper, Cubase, Garageband, Audacity, and many, many more.

You can mix and record to the SD card even when using the MixPre-6 as a USB audio interface. This opens up cool opportunities for recording the computer's USB audio output and mixing it with other mic and line sources plugged into the MixPre, making it ideal for podcasting and recording interviews via Skype or any other VoIP application.

This simultaneous recording/USB audio streaming capability also makes the MixPre ideal as a backup to a computer—highly desirable in mission critical applications where relying only on a computer might be a risk.

The recording functionality is dependant on the current operating mode, Basic or Advanced.

In Basic mode, the MixPre-6 functions as a two-track 48 kHz recorder. The two record tracks are fed by the LR mix which is driven directly by the channel knob gains.

In Advanced Mode, the MixPre-6 is configured as a eight-channel recorder with user-selectable 44.1, 48, 96 and 192 kHz sample rate and 16 and 24bit depth. The LR mix tracks may be recorded as well as each of the six channels as individual isolated (ISO) tracks. Audio for the ISO tracks is recorded "prefade" meaning before the channel knob gain, so any changes that are made there will only affect the LR mix and have no affect on the recorded ISO track levels. This is particularly useful for post-production audio processing where it may be desirable to create an alternate mix of the tracks at a later stage.

Formatting SD Cards

SD cards must be formatted by the MixPre-6 for reliable recording and playback. Be sure to backup any wanted audio recordings or data on the SD card before formatting since the formatting process erases all data on the SD card.

We highly recommend using Sound Devices branded SD cards as these have been optimized to provide the best performance. If these are not available, most reputable manufacturers' cards (such as SanDisk or Delkin) that meet or exceed class 10 speeds are acceptable.

To format an SD card:

1. Insert an SD card in the slot located on the rear panel.
2. Tap .
3. Tap SD Card > Edit > Format.
4. When asked to confirm the command to format the card, tap OK.

Cards with a capacity of 32 GB or less will be formatted with the FAT32 file system. Cards with a capacity greater than 32 GB will be formatted with the exFAT file system.



① The exFAT file system is not compatible with Windows XP or Mac OS X 10.6.4 and lower.

The status bar displays the SD card’s remaining record time, which will vary based on the storage capacity of the card being used. Other variables that affect digital recording times include concurrent audio track count, sample rate, and bit depth. Here are some record time estimates for a 16 GB SD card.

FORMAT & RATE	TRACKS	RECORDING TIME
WAV - 48 kHz / 24 bits	8	4 hours 2 ¾ minutes
WAV - 96 kHz / 24 bits	2	8 hours 5 ½ minutes
WAV - 192 kHz /24 bits	2	4 hours 2 ¾ minutes

Transport Controls

The three Transport controls (illuminated buttons) on the front panel are used to perform recording and playback functions.

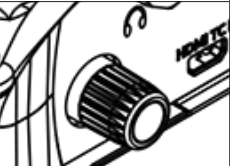
FUNCTION	CONTROL	ACTION
Record		Press to begin recording a new file. The button illuminates red while recording is in underway. <i>① Recording may also be triggered from rolling timecode or from compatible DSLR cameras with HDMI output. For more information, see the "HDMI Record Trigger" and "Linear Timecode (LTC) Record Trigger" sections of this guide.</i>
Stop		While recording, press once to stop recording. While in playback, press once to stop playback. While in standby, press and hold to display next take name.
Play / Pause		Press to begin playback of the last file recorded or file currently loaded. The button illuminates green during playback. While in playback, press once to pause, and press again to resume playback. Whenever playback is paused, the button and the current file name will flash green.
Scrub		While playing or paused, press and hold the headphone encoder to enter Scrub mode. Then rotate clockwise for fast forward or counter-clockwise for rewind at speeds of 0x, 1/8x, 1/4x, 1/2x, 1x, 2x, 4x, 8x and 16x. The audio may be heard in Scrub mode up to 2x speed.

In Basic mode, only the L/R mix bus will be recorded. Recording is as easy as pressing the REC button. Push the Play button to play back files and the Stop button to stop Recording or Playback. Pushing the Play button while in Play mode, will initiate Pause mode. The Play button as well as the active file in the display will flash to indicate that Pause is active.

In Advanced Mode, all channels as well as the L/R mix bus may be recorded individually. The channel must be “armed” to record individual channels as ISO tracks.

To arm a channel:

1. Press the channel knob.
2. Tap Arm.

Armed channels are indicated in the meters view with red meter labels surrounding the channel number. If neighboring channels are stereo linked, their labels are merged to indicate that they are linked. See [Channel Inputs](#) for more information regarding stereo linking.

Record Menu

In Basic mode, the Rec Trigger function is used to automatically start and stop recording from a compatible HDMI source, such as a DSLR. This cool feature lets you simultaneously start recording on a DSLR and the MixPre-6 just by pressing the Record button on the camera, thus eliminating the possibility of forgetting to record audio on the MixPre-6—not something that a producer will take kindly to!

In Advanced mode, there are many more settings available, as shown in the following table:

SUB-MENU	DESCRIPTION	OPTIONS
Rec L,R Mix	Arms L and/or R mix buses.	<ul style="list-style-type: none"> • L&R Linked • L&R • L • R • Off • Off & Linked
Left Gain	Sets the gain for the L mix.	• -30 - 0 dB (1 dB increment)
Right Gain	Sets the gain for the R mix. This setting is disabled when Rec L,R Mix is set to LR Linked.	• -30 - 0 dB (1 dB increment)
Sample Rate	The internal sample rate and sample rate of recorded WAV files. The default is 48kHz.	<ul style="list-style-type: none"> • 44.1 kHz • 48 kHz • 96 kHz • 192 kHz
Bit Depth	The bit depth of recorded WAV files. The default is 24.	<ul style="list-style-type: none"> • 24 • 16

SUB-MENU	DESCRIPTION	OPTIONS
Pre-roll Time	Allows for the recording of audio before Record is pressed. ⓘ <i>Maximum Pre-roll Time is reduced at 96 kHz and higher sampling rates.</i> ⓘ <i>Pre-roll is unavailable when triggering recordings from HDMI TC.</i>	<ul style="list-style-type: none"> • 0-5 (1 sec increments)
Rec Trigger	Sets record triggering from either timecode or HDMI flags. The default is Off.	<ul style="list-style-type: none"> • Off • HDMI flag • Timecode
Remix	Enables playback and re-record of any existing file to create a new LR mix by adjusting ISO tracks' fader levels and pans. Remix is Off by default. ⓘ <i>For more information, see Remixing ISOs.</i>	<ul style="list-style-type: none"> • Off • On
Record Bells	Enable or disable record bell notifications. Record bells are On by default.	<ul style="list-style-type: none"> • Off • On

Working with Cue Marks

The MixPre recorders uses cue marks to make it easy to locate quickly to points of interest.

To add cues marks:

- ▶ During recording, playback, or pause, tap , the Q icon at the top of the Home screen to add a cue mark exactly at that point in the song. A cue mark number (starting from 01 and incrementing each time a new cue mark is added) is displayed next to the Q icon.

The MixPre automatically rennumbers cue marks if one is inserted between existing cue marks to maintain their ascending numerical order from start to finish—01, 02, 03, etc.

Cues appear in numerical order in the Cue List, such as those shown in following image.

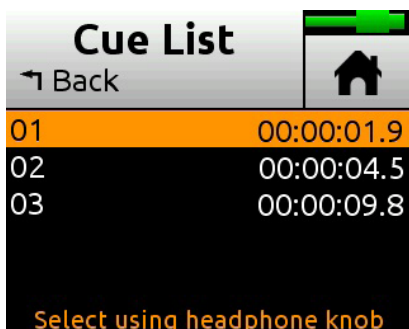

To access the Cue List:

1. Tap .

2. Use the HP encoder to select a file (or highlight a file and tap Edit).
3. Tap Cue List from menu.

Cues may be named, moved, deleted from the Cue List.

- ① *With the Musician plugin installed, they may also be used to set up as transport cue points for automatic punch in/out regions. You cannot rename these Playback or Record In/Out points. For more information about Play In, Record In/Out, and Stop points, see [Punching In/Out in the Musician Plugin chapter](#).*

To custom name a cue mark :

1. From the Cue List, use the HP encoder to select a cue mark.

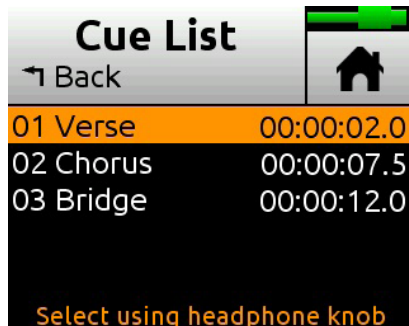

2. Tap Name and enter a new name.

Moving Cue Marks

You can finely tune the position of cue marks in 0.1 second increments.

To move cue marks:

1. From the Cue List, use the HP encoder to select a cue mark.

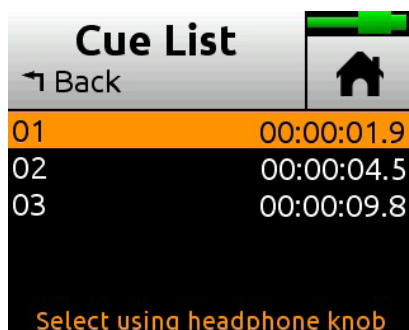

2. Tap Move and rotate the HP encoder to adjust the selection in 0.1 second increments.

Clearing & Deleting Cue Points

You can delete cue marks and clear Play In, Record In/Out, or Stop points via the Cue Points menu or Cue List screen.

To clear all In and Out stored values:

- ▶ Tap Clr In/Out.

To clear an individual Play In, Record In/Out, or Stop point:

- ▶ Select one from the Cue List and tap Disable.

To delete a cue mark:

1. From the Cue List, select a cue mark.
2. Tap Delete.

Remixing ISOs

Imagine recording multiple ISOs on location only to later discover the original LR mix just isn't quite right. Perhaps one ISO was too soft, making dialog at that point hard to hear, or perhaps another ISO picked up a loud noise when something brushed across someone's lav.

Normal playback lets you listen to the recorded LR mix track. However, the Remix feature allows you to playback a selected file and readjust its ISO tracks' fader levels and pans. You can also re-record a whole new LR mix—complete with all metadata from the original source file—while remixing the playback. The re-recorded 2-channel LR mix becomes a new poly wav file with the same original source file name prefixed with the characters "R_".

Requirements for Remix:

- Only available in Advanced mode, or Custom mode with Gain set to Advanced.
- The source file must include at least one ISO track.

To enable Remix:

1. Tap .
2. Tap Record > Remix > On.

To re-record a new remixed LR track:

1. Ensure Remix is On.
2. Tap .
3. Use the HP encoder to select a file (or highlight a file and tap Edit).

4. Tap Re-record LR. Playback and recording will begin immediately.
5. Use rotary faders to remix the playback.

USB Audio Interface

The MixPre-6 has an integrated 8-in, 4-out core audio-compatible interface for use with a Mac or PC computer. For PC users, the MixPre-6 will appear as a 2x2 audio interface unless a specific ASIO® driver is installed. The latest ASIO driver can be downloaded at www.sounddevices.com/support/downloads. See the MixPre Series Downloads page.

To work with the USB audio from a host computer, it is necessary to route the USB 1 - 4 sources appropriately. Should you want to mix the USB audio from the host computer with live audio from the MixPre-6's inputs to the LR bus, use the channel screen and select input source (Advanced mode only). To hear the USB host computer audio in the headphones only, switch the HP preset to USB 1,2 or USB 3,4.

The MixPre-6 is capable of recording and streaming audio to a USB host simultaneously. The MixPre-6 is also capable of recording the USB audio stream out of a computer directly to its SD recorder. This is an amazingly-useful feature for recording any computer-based audio. See the table below detailing the MixPre-6's channel to output assignments.

CHANNEL	USB OUTPUT ASSIGNMENT
Channel 1	USB stream 1
Channel 2	USB stream 2
Channel 3	USB stream 3
Channel 4	USB stream 4
Channel 5	USB stream 5
Channel 6	USB stream 6
Mix bus L	USB stream 7
Mix bus R	USB stream 8

Low-latency Monitoring

We've worked really hard with our hardware, logic and software design teams to minimize latency. We've found that in many scenarios, latency when monitoring through a DAW (digital audio workstation) is perfectly acceptable, depending upon DAW software, computer hardware and plug-ins.

In situations where the throughput latency is higher than desired, the input to the MixPre-6 can be directly monitored in the headphone output.

To monitor with zero-latency through the MixPre-6:

1. Connect MixPre-6 to computer.
2. Confirm that the "LR Stereo" HP Preset is selected.
3. Select "USB1" for Channel 5 source and Pan L.
4. Select "USB2" for Channel 6 source and Pan R.
5. Connect microphone or other inputs to Channels 1-4.
6. Select the appropriate inputs for Channels 1-4. These will appear to your computer as USB stream 1-4 respectively.
7. Setup your DAW software for a new track with its source being any Channels 1-4 and be sure that record monitoring is disabled for these tracks. (Optionally, you may mute the channel's output in the DAW).
8. You should now be able to hear and adjust the output of your DAW audio through Channels 5 and 6 while adjusting your low-latency feed in your headphones (and send levels to DAW) using the channel 1-4 knobs. Use Gain (Inputs > Ch 5 or Ch 6 Screens) to adjust the mix of the DAW audio with channels 1-4 to taste.

USB File Transfer

The MixPre-6 can support USB file transfer between its SD and a USB-connected host computer. In order to use this feature, it's necessary to put the MixPre-6 into File Transfer mode. (USB audio will be suspended.)

To enter File Transfer mode:

1. Tap .
2. Tap System > File Transfer.
3. When file transfer is complete, tap Exit on the USB-C File Transfer Mode screen to return to the previous operating state.



USB Keyboard

The use of standard USB computer keyboards is supported. When using the MixPre-6 in situations requiring extensive metadata entry, titling and wired remote control capability, a USB keyboard may be desirable.

- ① *Keyboards with an embedded USB hub and Apple brand keyboards are not compatible. Additionally, some keyboards must be connected only after the recorder is turned on.*

USB-C Mode

When connected to a computer via USB-C, the MixPre-6 may be setup to be powered from the host without the computer identifying it as an audio interface.

To toggle between the USB-C audio/power modes:

1. Tap .
2. Tap System > USB-C. Options include: Audio and Power Only.

Adjusting USB Audio Output

The MixPre offers the option to set the USB Audio interface to output only two channels in order to increase compatibility with applications that do not support multichannel USB audio.

To set USB Audio to output only two channels:

1. Tap .
 2. Tap System > USB Audio, and set it to Stereo Out.
- ① *When USB Audio is set to Stereo Out, the MixPre does not receive USB audio from a computer. Additionally, the ASIO driver (for Windows PCs) is not supported when USB Audio is set to Stereo Out.*





Timecode

Timecode Modes

The MixPre-6 is not only a fantastic tool for audio enthusiasts. It was also conceived for all you video aficionados out there, whether you are a film or documentary maker or a YouTuber who wants no-compromise audio quality to go along with their video content.

With that in mind, we have designed-in timecode capability to make it easy to lip-sync DSLR and other camera video with the MixPre-6's audio. This is particularly useful in what is known as 'double system sound' applications where audio is recorded separately from the video camera. In simple video/audio productions, it is often sufficient to simply use the MixPre-6 as a high quality mic-preamp/mixer and record the audio on the DSLR into the same file as the video content. This is known as single system and in this case, the video and audio are already lip-synced. However, there are often times where it is very beneficial to record each audio source as a separate isolated (ISO) track. Access to these ISO tracks allows the ability to clean up and remix audio sources after the event in post production. To record ISO tracks and sync them with video from a DSLR, you need a multichannel recorder with built in timecode support like the MixPre-6.

In the audio for video category, no one does timecode better than Sound Devices. It's no surprise that many Oscar winning movies have had their sound recorded using Sound Devices gear.

For some reason, timecode gets a bad rep as being difficult to understand, but really it is quite simple. It is basically a time label that runs from 0 to 24 hours and is counted in hours (HH), minutes (MM), seconds (SS), and frames (FF). A timecode value will look like this - HH:MM:SS:FF. Timecode ranges from 00:00:00:00 to 23:59:59:29, then starts over.

All you have to do to synchronize separate video and audio content is to ensure that the camera and MixPre-6 are both labeling each moment in time with the same timecode value. Then in your video editing software, whether it be Final Cut, Adobe Premiere, or Avid Media Composer, you simply import your separate audio and video content and match up the timecode numbers (computers are good at matching up numbers) and "Hey Presto," you have lip-synced video and audio.

The MixPre-6 has three timecode modes, HDMI TC In, Aux In 1 or 2, and Time of Day.

HDMI TC In

Use a DSLR camera that outputs timecode over its HDMI output connection. A few examples of cameras that do this are the Sony a7s and Panasonic GH4. Connect their HDMI output to the HDMI TC In port on the MixPre-6's right hand panel and set Menu>Timecode>TC Mode to HDMI TC In. Refer to the camera's user guide to determine how to output HDMI timecode from the camera since all cameras do it in a slightly different way.

When the MixPre-6 receives HDMI timecode, it is displayed on the Home screen beneath the current filename. Each time you press record, the incoming timecode value is stored inside the MixPre-6's WAV file. Most popular video editing applications will be able to read this timecode value and sync the audio with the camera video.

Aux In 1, Aux In 2

LTC, otherwise known as SMPTE Linear Timecode is the most common timecode standard. Many professional cameras and other devices output this format. This can be received by the MixPre-6 via its Aux/Mic In 3.5mm connector.

To enable Aux In Timecode:

1. Set the Aux In Mode to Timecode (Menu>Inputs>Aux In Mode) - this is only available in Advanced mode.
2. Set Menu> Timecode>TC Mode> to Aux In 1 or Aux In 2.

When the MixPre-6 receives Aux In timecode, it is displayed on the home screen beneath the current filename.

Time of Day (TOD)

Use TOD mode, when you want the recorded WAV files to be timecode stamped with the time of day. The time of day is derived from the MixPre-6's built-in date/time clock. This mode is not used for frame accurate synchronization with external devices. Rather, it is used as simple way of logging what time a recording took place.

Timecode Frame Rate Auto-Detection

With both the HDMI TC In and Aux In Timecode modes, the MixPre-6 auto-detects the incoming timecode frame rate and stamps the recorded files accordingly.

Timecode Stamp

Regardless of which timecode mode you use, each time you press record, the timecode value at that moment is embedded within the MixPre-6's WAV file. Most popular video editing applications will be able to read this timecode value and sync the audio with the camera video.

For those of you who are curious, WAV files that contain embedded timecode are called Broadcast WAV files. They are identical to standard WAV files but contain extra non-audio metadata such as timecode and other descriptive data about the recording.



Files and Projects

Each time you press record, the MixPre-6 creates a WAV audio file which can subsequently be played back on the MixPre or almost any computer audio application. The MixPre-6 is able to record up to 8 tracks (the stereo mix LR tracks plus 6 isolated tracks) into a single polyphonic WAV file. Polyphonic simply refers to the fact that the file contains multiple tracks.

File Name Format

The MixPre-6 makes it easy to identify and organize your recordings (WAV files) by providing the ability to name them before, during, or after recording.

Each recording's file name is comprised of a Name (maximum 20 characters), followed by a dash (-), and then followed by a Number (3 digits). For example:

MIXPRE-001.WAV

Name = MIXPRE

Number = 001

Each time you press record, the Number is incremented.

The Number is reset to 1 whenever you create a new Name.

Naming a Recording

To name a recording:

1. Go to the File List by tapping the top left region of the Home screen.
2. Select a file from the list by using the headphone encoder on the right panel. Rotate to highlight a file then press the encoder (or touch Edit) to select it for naming or press the Play button to play it.

① The File List is in chronological order with most recent recordings at the top of the list. The row at the very top of the list represents the next file to be recorded. Selecting this allows you to give a name to the next recording prior to recording it.
3. Select Name to edit the Name.
4. Select Number to edit the Number.

The Name and Number not only determine the filename of the recording—they are also embedded inside the WAV file. This is particularly useful in film and TV production where the data is used to help log and locate content faster.

In Advanced mode you can also rename a recording.

To rename a recorded file:

- ▶ In the File List, select a file by pressing the encoder, and tap Rename.

Track Names and Notes

In Advanced mode, you also have the option to store track names and notes inside the WAV file. This is ideal for multitrack recording where you want to identify what or who is recorded on a particular track and for adding descriptive notes about the recording that might be useful to an editor at a later stage.

To edit track names and notes:

1. In the File List, select a file and press the encoder
2. Do any of the following:
 - ▶ Select Track Names to change track names.
 - ▶ Select Name, Num Notes to edit notes.

Undo, Trash File

In Advanced mode, you can undo the last file recorded. Undo moves the last recorded file to the SD card's UNDO folder. Files in this folder are accessible using a computer.

To undo your last recording:

- ▶ In the File List, select a file, press the encoder, and tap Undo.

To trash any file in the File List:

1. In the File List, highlight a file, and tap Edit.
2. Select Trash Take.

Trash File moves the file to the SD card's TRASH folder. Files in this folder are accessible using a computer. You can permanently delete files in the SD card's TRASH folder from the MixPre's SD Card menu.

Projects

It is easy to end up with many hundreds of WAV files on a single SD card, especially as cards can hold many gigabytes of audio data. To help organize this large number of files, they may be stored in separate folders which, in the MixPre-6, are known as Projects. For instance, you may want to organize your recordings based on their type, such as PODCASTS, SONGS, INTERVIEWS, SOUND FX, NATURE RECORDINGS, etc. Each of these projects would be

represented by a folder located at the root of the SD card.

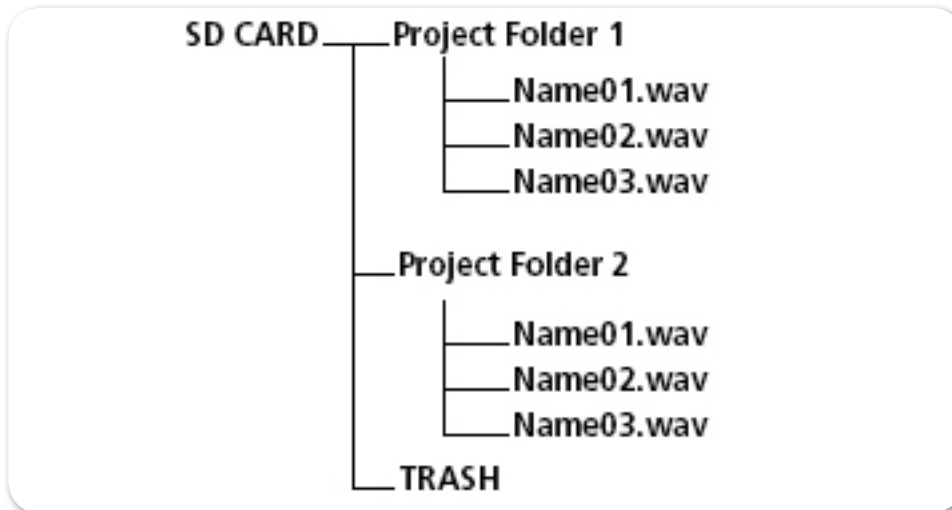

To create a new Project:

1. Tap .
2. Tap Project > New and choose to create a custom project name or project name based on the current date.

To access files or record new files in a previously created project:

1. Tap .
2. Tap Project > Open.
3. Select the required project. This will load the File List with the selected Project's files.

① *Project files are sorted by creation date. Rerecorded files are always placed in the same project folder as the source file.*

To trash a Project:

1. Tap .
2. Tap Project > Trash.
3. Select which project to trash. This moves the selected project and all its files to the TRASH folder. Projects in this folder are accessible using a computer.

① *You can permanently delete projects in the SD card's TRASH folder from the MixPre's SD Card sub-menu.*

Remote Control

Wingman Application

Sound Devices Wingman is a free app—available for download from Google Play and Apple’s App Store—that allows wireless remote control of the Bluetooth Smart-enabled MixPre Series from Android or iOS devices.

To enable Bluetooth on the MixPre recorder:

1. Tap .
 2. Tap System > Bluetooth. This toggles Bluetooth On and Off.
- ① *If a remote password is configured on the recorder itself, Wingman will prompt for that password to be entered prior to making the connection.*



Wingman's touch-screen user interface offers easy navigation and monitoring with three main areas of interest:

- **Status** - Shows device-specific status information.
- **Viewing area** - Displays different screen views, such as the Transport view with its transport control buttons, metadata fields, and meters. Swiping vertically in this area can toggle to other meters. Swiping horizontally, toggles between Transport and Track views, handy when using Wingman app on devices with smaller screens.

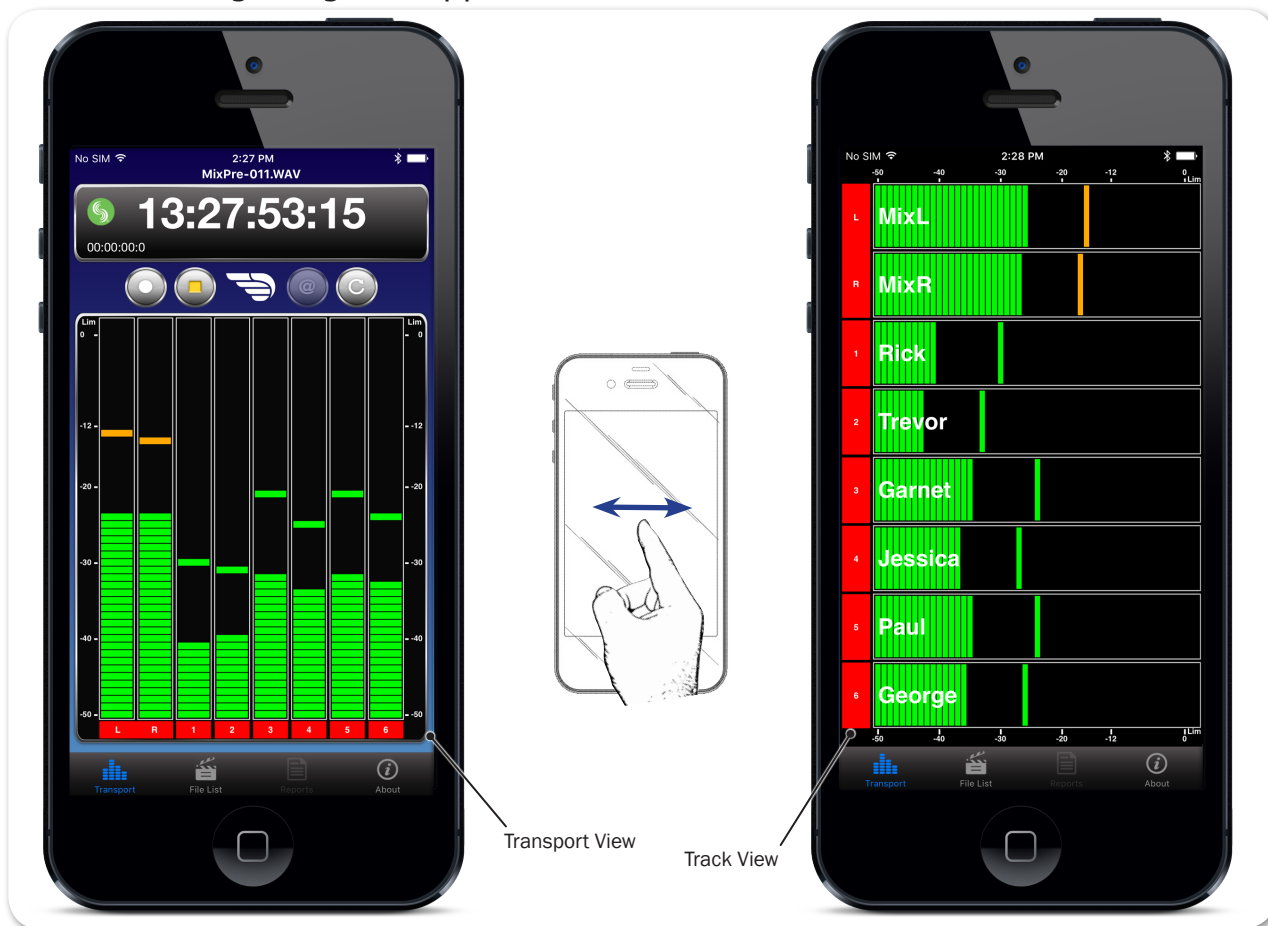

- **Tab bar** - Remaining on screen all the time, the bar has four icons enabling access to other views, such as the File list.

① *Not all buttons, icons, or views are enabled or used for MixPre functionality.*





Connecting to a MixPre Recorder

If multiple Wingman-enabled devices are on set, Wingman will display all available devices within range. You may tap the Connection icon to efficiently switch connection from one device to another from within the app.

- ① *For productions with multiple recorders of the same model, tapping the Circled-I icon helps identify the correct device, by displaying an "Identifying from Wingman" message on the chosen recorder's screen.*



When running Wingman, the Connection icon, which bears the Sound Devices logo, displays different colors. The color of the icon is significant:

COLOR	ICON	STATUS
Gray		Disconnected - either no activity or scanning for devices
Orange		Bluetooth connection in progress
Yellow		Connected - authentication underway
Green		Connected and authenticated

Music Projects via Wingman

Beginning with version 3.20, the Wingman app includes support of Bluetooth connection to any MixPre model with the Musician Plugin activated, as well as all M-models of the MixPre Series.

When connecting to a MixPre, Wingman’s user interface changes based on the model to which it connects and the type of project opened on the MixPre.

For instance, in Music projects, the Transport view displays a single meter view with all 12 tracks. Likewise, since there is no File list for Music projects, the File List icon is removed from the Tab bar. In addition to Record and Stop, the

Transport control buttons include a Play button for playback, as opposed to the False Take (or “Undo”) button provided on models in Audio projects.



① *Regardless of model or project, custom naming and arming of tracks may be done in Transport view (shown above) on large screen mobile devices, like tablets, or in Track view on smaller screen mobile devices, like smartphones.*

To rename tracks:

1. Do either of the following:
 - ▶ On large mobile devices, from the Transport view, tap anywhere in a vertical meter for the track you want to edit.
 - ▶ On small mobile devices, swipe horizontally to display the Track view, then tap anywhere in a horizontal meter for the track you want to edit.
2. Use the virtual on-screen keyboard to modify the track name.
3. Tap Done when finished to save the changes.

① *Tap anywhere on screen other than the keyboard to exit without saving changes.*

To arm/disarm tracks:

- ▶ Tap the meter label. When armed the label turns red. When on but disarmed, the label is gray. When the input is off, the label is black and cannot be armed. And in Music projects, when playing back or overdubbing, labels for on but disarmed tracks appear green.
- ① *Meter labels are joined (displayed as a single label) to indicate when channels are linked. This is shown in the previous example; see the meter labels for 9 and 10.*

HDMI Record Trigger

The MixPre-6 may be configured to begin recording when it is triggered to do so from an HDMI record flag from compatible DSLR cameras with HDMI output. By default, record triggering is turned off. Setting the Record Trigger to HDMI flag will initiate record when a compatible device issues the record flag via the HDMI input.

To access the Record Trigger settings:

1. Tap .
2. Tap Record > Rec Trigger.

Linear Timecode (LTC) Record Trigger

The MixPre-6 may be configured to begin recording when it detects running LTC timecode via the Aux input when set to Timecode. Set Rec Trigger to Timecode to activate this feature.

Keyboard

A connected USB keyboard may be used as a wired remote control for certain functions of the MixPre-6. See the table below for available USB keyboard shortcuts.

USB Keyboard Shortcuts

When a USB keyboard is attached, the following key-combinations or shortcuts are available.

KEYSTROKES	ACTION
Escape	Back. Also cancels out of editing mode when virtual keyboard is on screen
F1 or Menu key	Accesses the Main menu
F12	Home
F2	File list
F3	Cycles between available Meters views and the Main screen
Ctrl + R	Record
Ctrl + S	Stop
Spacebar	Play
Left Arrow	Main screen: Rewind Menu and Input Settings screens: Toggles through pages
Right Arrow	Main screen: Fast forward Menu and Input Settings screens: Toggles through pages
Up / Down Arrows	Main screen: Adjusts headphone volume In menus: Duplicates encoder rotation, such as moves highlight, scrolls list While editing parameters: Changes the value
Enter	In menus: Activates current selection. (Same as encoder press.) Also, same as choosing OK when virtual keyboard is on screen
Q	In menus: select top left option in quad button view
W	In menus: select top right option in quad button view
A	In menus: select bottom left option in quad button view
S	In menus: select bottom right option in quad button view
1-6	Channel Settings screen for 1-6

USB Controllers

Beginning with firmware v3.00 and higher, the MixPre Series (including M models) can be connected to selected third party controllers for tactile control of mixing and recording.

No matter whether you are creating music, podcasts or recording sound for picture, these control surfaces provide yet another cool way to interact with your MixPre in addition to operating MixPre direct from its front panel or from the Bluetooth Wingman App for iOS and Android.

The MixPre-Series can be controlled by the following USB controllers:

- Korg NanoKontrol Studio
- Korg NanoKontrol 2
- Novation LaunchControl XL
- Akai MidiMix

These control surfaces provide a varied range of physical sliders, pots, and buttons to set fader levels, trim gains, pans, reverb sends, solos, mutes, record arming, transport control and more. Functionality varies depending on controller model and whether you are working in Music or Audio projects.

① *Not all functions are supported by all controllers.*

Connecting the MixPre to a Controller

Power and control is provided via a single USB cable to better facilitate simple connection between the MixPre and controller. To ensure compatibility with the connected controller, the MixPre must first configure itself accordingly.

① *For the MixPre-3 and -6, USB Controllers will only function if the MixPre is adequately powered.*

To connect a controller:

1. Connect one end of a USB cable to the MixPre's USB-A port and the other end to the controller's USB port which can be a USB-B, Micro USB, or Mini USB port depending on the controller model.

We recommend using the USB cable supplied with the controller.

① *It is okay to connect the MixPre to the controller while powered up.*

2. The MixPre automatically starts setting itself up to work with the attached controller. During this short time, a popup displays the controller model. After a few seconds, the popup closes and the controller is ready to use.

① *When connected to the MixPre, some functions are taken over by the controller*

and are therefore disabled on the MixPre. Depending on the controller model, these functions may include faders, trims, pans, reverb sends, and low cut filters.

Map User-Definable Buttons to Shortcuts

You can customize designated buttons/knobs on a controller to operate certain functions on the MixPre. Functions that may be assigned include:

- Tone
- L/R Mute
- X1/X2 Mute
- Undo (Audio project only)
- Slate Mic (Audio project only)
- Metronome (Music project only)
- Add Q
- Record
- Stop
- Play
- Rewind
- Fast Fwd
- Shuttle (not all controllers)

To map controller buttons to perform MixPre functions:

1. Connect a controller.
2. On the MixPre, access Menu > * Shortcuts > Control Surface
3. Set any of the user-definable shortcut buttons to your required function.

Controller Interfaces

Each third-party controller has different capabilities. The following tables [Akai MidiMix Interface](#) | [Korg NanoKontrol 2 Interface](#) | [Korg NanoKontrol Studio Interface](#) | [Novation LaunchControl XL Interface](#) describe the functionality of each controller in Music and Audio projects:

① *The MixPre M-Series models do not support Audio projects.*

Akai MidiMix Interface



FUNCTION	MUSIC PROJECTS	AUDIO PROJECTS
Fader Bank Switching	Bank Left = Select fader bank to the left Bank Right = Select fader bank to the right	--
User-Definable Shortcut Buttons	Solo + Bank Left Solo + Bank Right	Solo + Bank Left Solo + Bank Right
Record	via user-definable shortcut	via user-definable shortcut
PLAY	via user-definable shortcut	via user-definable shortcut
STOP	via user-definable shortcut	via user-definable shortcut
FFWD X2, X16	via user-definable shortcut	via user-definable shortcut
RWD X2, X16	via user-definable shortcut	via user-definable shortcut
Skip Next File	--	via user-definable shortcut (Tap Fast Forward)
Skip Prev File	--	via user-definable shortcut (Tap Rewind)
Skip Next Mark	via user-definable shortcut (Fast Forward)	via user-definable shortcut (Fast Forward)
Skip Prev Mark	via user-definable shortcut (Rewind)	via user-definable shortcut (Rewind)
Return to Zero	via user-definable shortcut (Stop twice)	via user-definable shortcut (Stop)
Shuttle	Only via MixPre	Only via MixPre
Record Arm	REC Arm button	REC Arm button
Record Arm Status	Red REC Arm button when armed	Red REC Arm button when armed
Input Monitor	Solo + REC Arm buttons	--
Input Monitor Status	Red REC Arm button when Solo is pressed	--

FUNCTION	MUSIC PROJECTS	AUDIO PROJECTS
Channel Screen Access	Press Bank Left/Right and REC Arm to access channel screen	Solo + REC Arm buttons
Faders	Linear faders 1-8	Linear faders 1-8
Trims	Top row knobs	Top row knobs
Pans	Bottom row knobs	Bottom row knobs
Reverb	Middle row knobs	--
Low Cut	Only via MixPre	Middle row knobs
Mute	Mute button	Mute button
Solo	Solo + Mute buttons	Solo + Mute buttons
Mute Status	Yellow Mute button	Yellow Mute button
Solo Status	Yellow Mute button when Solo is pressed	Yellow Mute button when Solo is pressed
L/R (Stereo) Output Gain	Master fader	Master fader
L/R (Stereo) Output Mute	via user-definable shortcut	via user-definable shortcut
X1/X2 Mute (10M/10T only)	via user-definable shortcut	via user-definable shortcut
Tone	via user-definable shortcut	via user-definable shortcut
Metronome	via user-definable shortcut	--
Create Q	via user-definable shortcut	via user-definable shortcut
Undo	Only via History List on MixPre	via user-definable shortcut
Internal Mic (10M/10T only)	Only via Input patchbay	via user-definable shortcut
SEND ALL Button	Sends all current fader, knob settings to MixPre	Sends all current fader, knob settings to MixPre

Korg NanoKontrol 2 Interface



FUNCTION	MUSIC PROJECTS	AUDIO PROJECTS
Fader Bank Switching	Track < button = Select fader bank to the left Track > button = Select fader bank to the right	--
User-Definable Shortcut Buttons	Cycle + Marker Set Cycle + Marker < Cycle + Marker > Cycle + << Cycle + >>	Cycle + Marker Set Cycle + Marker < Cycle + Marker > Cycle + << Cycle + >>

FUNCTION	MUSIC PROJECTS	AUDIO PROJECTS
Record	Record button	Record button
PLAY/Pause	Play button	Play button
STOP	Stop button	Stop button
FFWD X2, X16	Hold >> button	Hold >> button
RWD X2, X16	Hold << button	Hold << button
Skip Next File	--	Tap >> button
Skip Prev File	--	Tap << button
Skip Next Mark	Tap >> button	Tap >> button
Skip Prev Mark	Tap << button	Tap << button
Return to Zero	Tap Stop when stopped	Tap Stop
Shuttle	Only via MixPre	Only via MixPre
Record Arm	R button	R button
Record Arm Status	Red R button when armed	Red R button when armed
Input Monitor	Cycle + M button	--
Input Monitor Status	Red M button when Cycle pressed	--
Channel Screen Access	Cycle + S button	Cycle + S button
Faders	Linear faders 1-8	Linear faders 1-8
Trims	Rotary knobs (set to trim)	Rotary knobs (set to trim)
Pans	Rotary knobs (set to pan)	Rotary knobs (set to pan)
Reverb	Rotary knobs (set to reverb)	--
Low Cut	Only via MixPre	Rotary knobs (set to low-cut)
Mute	M button	M button
Solo	S button	S button
Mute Status	Red M button	Red M button
Solo Status	Red S button	Red S button
L/R (Stereo) Output Gain	Only via MixPre	Only via MixPre
L/R (Stereo) Output Mute	via user-definable shortcut	via user-definable shortcut
X1/X2 Mute (10M/10T only)	via user-definable shortcut	via user-definable shortcut
Tone	via user-definable shortcut	via user-definable shortcut
Metronome	via user-definable shortcut	--
Create Q	Marker Set button	Marker Set button
Undo	Only via History List on MixPre	via user-definable shortcut
Internal Mic (10M/10T only)	Only via Input patchbay	via user-definable shortcut

Korg NanoKontrol Studio Interface



FUNCTION	MUSIC PROJECTS	AUDIO PROJECTS
Fader Bank Switching	Track < button = Select fader bank to the left Track > button = Select fader bank to the right	--
User-Definable Shortcut Buttons	Cycle + Marker Set Cycle + Marker < Cycle + Marker > Cycle + << Cycle + >>	Cycle + Marker Set Cycle + Marker < Cycle + Marker > Cycle + << Cycle + >>
Record	Record button	Record button
PLAY	Play button	Play button
STOP	Stop button	Stop button
FFWD X2, X16	Hold >> button	Hold >> button
RWD X2, X16	Hold << button	Hold << button
Skip Next File	--	Tap >> or Marker > button
Skip Prev File	--	Tap << or Marker < button
Skip Next Mark	Tap >> or Marker > button	Tap >> or Marker > button
Skip Prev Mark	Tap << or Marker < button	Tap << or Marker < button
Return to Zero	Tap < or Stop when stopped	Tap < or Stop
Shuttle	Press MixPre HP encoder or set Shuttle as a shortcut, then use selected shortcut and scrub wheel.	Press MixPre HP encoder or set Shuttle as a shortcut, then use selected shortcut and scrub wheel.
Record Arm	REC Arm button	REC Arm button
Record Arm Status	White REC Arm button when armed	White REC Arm button when armed
Input Monitor	Select button	--
Input Monitor Status	White Select button	--

FUNCTION	MUSIC PROJECTS	AUDIO PROJECTS
Channel Screen Access	Press Cycle so that it's illuminated, then press a Select button	Select button
Faders	Linear faders 1-8	Linear faders 1-8
Trims	Scene 1 then use knobs	Scene 1 then use knobs
Pans	Scene 3 then use knobs	Scene 3 then use knobs
Reverb	Scene 2 then use knobs	--
Low Cut	Only via MixPre	Scene 2 then use knobs
Mute	Mute button	Mute button
Solo	Solo button	Solo button
Mute Status	White Mute button	White Mute button
Solo Status	White Solo button	White Solo button
L/R (Stereo) Output Gain	Only via MixPre	Only via MixPre
L/R (Stereo) Output Mute	via user-definable shortcut	via user-definable shortcut
X1/X2 Mute (10M/10T only)	via user-definable shortcut	via user-definable shortcut
Tone	via user-definable shortcut	via user-definable shortcut
Metronome	via user-definable shortcut	--
Create Q	Marker Set button	Marker Set button
Undo	Only via History List on MixPre	via user-definable shortcut
Internal Mic (10M/10T only)	Only via Input patchbay	via user-definable shortcut

Novation LaunchControl XL Interface



FUNCTION	MUSIC PROJECTS	AUDIO PROJECTS
Fader Bank Switching	Track Select < button = Select fader bank to the left Track Select > button = Select fader bank to the right	--

FUNCTION	MUSIC PROJECTS	AUDIO PROJECTS
User-Definable Shortcut Buttons	UP DOWN Device + UP Device + Down Device + Left Device + Right	UP DOWN Device + UP Device + Down Device + Left Device + Right
Record	via user-definable shortcut	via user-definable shortcut
PLAY	via user-definable shortcut	via user-definable shortcut
STOP	via user-definable shortcut	via user-definable shortcut
FFWD X2, X16	via user-definable shortcut	via user-definable shortcut
RWD X2, X16	via user-definable shortcut	via user-definable shortcut
Skip Next File	--	via user-definable shortcut
Skip Prev File	--	via user-definable shortcut
Skip Next Mark	via user-definable shortcut	via user-definable shortcut
Skip Prev Mark	via user-definable shortcut	via user-definable shortcut
Return to Zero	via user-definable shortcut (Stop twice)	via user-definable shortcut (Stop)
Shuttle	Only via MixPre	Only via MixPre
Record Arm	Select Record Arm, then Track Control button	Select Record Arm, then Track Control button
Record Arm Status	Red Track Control button when Record Arm is selected	Red Track Control button when Record Arm is selected
Input Monitor	Track Focus buttons	--
Input Monitor Status	Illuminated Track Focus button Monitor is On	--
Channel Screen Access	Hold Device button, then Track Focus button	Track Focus buttons
Faders	Linear Faders 1-8	Linear Faders 1-8
Trims	Top row of knobs	Top row of knobs
Pans	Bottom row of knobs	Bottom row of knobs
Reverb	Middle row of knobs	--
Low Cut	Only via MixPre	Middle row of knobs
Mute	Select Mute, then Track Control button	Select Mute, then Track Control button
Solo	Select Solo, then Track Control button	Select Solo, then Track Control button
Mute Status	Red Track Control button when Mute is selected	Red Track Control button when Mute is selected
Solo Status	Flashing Track Control button when Solo is selected	Flashing Track Control button when Solo is selected
L/R (Stereo) Output Gain	Only via MixPre	Only via MixPre
L/R (Stereo) Output Mute	via user-definable shortcut	via user-definable shortcut
X1/X2 Mute (10M/10T only)	via user-definable shortcut	via user-definable shortcut
Tone	via user-definable shortcut	via user-definable shortcut

FUNCTION	MUSIC PROJECTS	AUDIO PROJECTS
Metronome	via user-definable shortcut	--
Create Q	via user-definable shortcut	via user-definable shortcut
Undo	Only via History List on MixPre	via user-definable shortcut
Internal Mic (10M/10T only)	via Input patchbay only	via user-definable shortcut



Musician Plugin

The Musician plugin brings the essence of computer-based music production software to the super-compact MixPre-3, -6 and -10T recorders.

Musicians and songwriters now have an easy to use, portable tool for creating high quality, multi-layered songs anywhere and anytime that inspiration grabs them.

It includes the following features:

- Track Laying
- Overdubbing
- Punch In/Out
- Track Bouncing
- Reverb and Vocal Air Effects
- Metronome
- Input to Track Routing
- Rendering
- Importing

The plugin works in a similar fashion to any DAW such as Protools, Logic, Cubase, Reaper etc.; however, it is intentionally simplified to allow musicians to focus on their art rather than getting bogged down in all the technical stuff.

The Musician plugin allows you to simultaneously record, playback, mix, monitor, layer, and overdub up to 12 tracks and if you need more, use the Bounce feature to free up more tracks. After your song is complete, you can mix and render (export) it for sharing with others.

With the plugin activated, there are two types of projects: the original Audio project and a new Music project. In a Music project, you can start recording, layering and overdubbing tracks, just like a DAW.

With the plugin, and in Music projects, the MixPre-3 lets you record three inputs simultaneously, the MixPre-6 allows you to record six inputs at once, and the 10T permits up to eight.

① *Music projects are limited to 96kHz. On MixPre-6 and MixPre-10T recorders, Audio projects do not have this limit, so the maximum sample rate for Audio projects remains 192kHz.*

The built-in metronome helps you to keep your performance in time while the reverb and vocal air effects add character to your recording and can aid in inspiring a great performance. The vocal air effect is an easily dialled-in combination of EQ and compression that results in an airy sheen and intimacy to vocals, popular today with singer/songwriters.

Installing and Activating the Plugin

The Musician plugin may be purchased from the Sound Devices online store at: <https://store.sounddevices.com/product/musicians-plugin/>.

To install and activate the plugin:

1. Purchase and download the license—an .LIC file—to an SD card.
 - ① *The Musician plugin is licensed to a MixPre recorder and its serial number, so it cannot be transferred to another device or to multiple MixPre devices.*
2. Insert the SD card into the MixPre and turn on the recorder.
 1. Tap .
 2. Tap System > Plugins.
 3. Tap Apply Plugins. This installs the license, activates the plugin, and reboots the device.

Music Projects

Each Music project’s folder on the SD card stores all your song’s audio files and settings. This makes it easy to organize, share, and copy your musical creations. The project folder also includes a special ‘session’ file that enables the MixPre to control precisely where on the timeline and on which track the project’s recorded audio files should be played back.

Conceptually, a Music project operates like a typical DAW and as such you can visualize it in much the same way. A play cursor moves across a horizontal timeline and audio tracks (referred to as ‘channels’ in the MixPre) are laid out as rows. A song always starts at 00:00:00:0 (hh:mm:ss:tenths), bar 1.



You can store many projects on an SD card, which is great if you are working on multiple songs or an album, because you can quickly switch between them.

Only one project is active at any one time.

Music Project Folder Structure

A Music project folder contains the following files:

- The project's recorded audio WAV files. Each track is represented by a single monophonic WAV file.

① *The file name is derived from the date and time the recording was finished. For example, a recording finished at 1:33 PM (13:33) on the 23rd of March 2018 would have a name like this: 001-032318-133300*

See [Music Project History](#) for more about the recorded files.

- A render folder containing all rendered audio files and a SESSION.XML file which manages how audio files are played back as well as storing settings for the project.

You can view the contents of a Project folder on a computer.

Creating a New Music Project

To create a new Music project:

1. Tap .
2. Tap Project > New > Music.

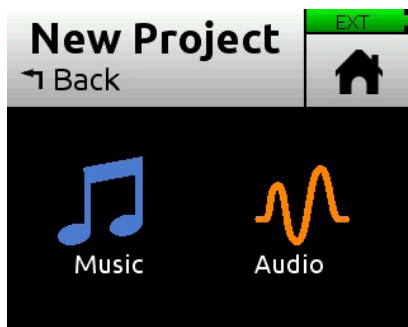

3. Enter a name and tap OK. By default the name is Song followed by a numerical value, such as Song1.
4. Tap Create. The new Music project is created with its name shown at the top of the Home screen.

① *When switching between Music and Audio projects, either when creating a new project or opening an existing one, the MixPre reconfigures to optimize performance for each project type. This reconfiguration requires that the unit restarts which can take a few seconds.*

Import Recording

When creating a new Music project, you may choose to import a .wav audio file (up to 12 tracks) as the foundation for your project. This is ideal for importing multitrack audio from a DAW should you want to continue developing your composition in the MixPre. Or perhaps you've created a backing track in your DAW for a live performance and want to use the MixPre as your all-in-one playback device and mixer during the show.

- ① *You may also import .wav files from Audio projects recorded using the MixPre-3M, MixPre-6M, or MixPre-10M models. File names must be kept to less than 40 characters; longer names are not supported.*

To create a project based on a non-native poly WAV file:

1. Tap .
2. Tap Project > New > Music > Import Recording.
3. Select your file from the those available on the SD card:
 - ▶ Use the HP encoder to select a .wav file from the root of the SD card.
 - ▶ Scroll to and select the an Audio project folder first, then choose a .wav file to import it from within the folder.

Opening an Existing Music Project

Open an existing song to continue working on it.

To open a Music project:

1. Tap .
2. Tap Project > Open. A list of all projects on the SD card are displayed. Music projects are identified by the Music Notes icon.
3. Scroll through the list and press the HP encoder to select the one you want. Once selected, the project is opened and the Home screen is displayed. You are ready to start recording.

- ① *When switching from the current project to another project, you do not need to worry about saving the current one - the MixPre auto-saves the current project's state. If switching between Music and Audio projects, the MixPre will reconfigure to optimize performance for each project type. This reconfiguration requires that the unit restarts which can take a few seconds.*

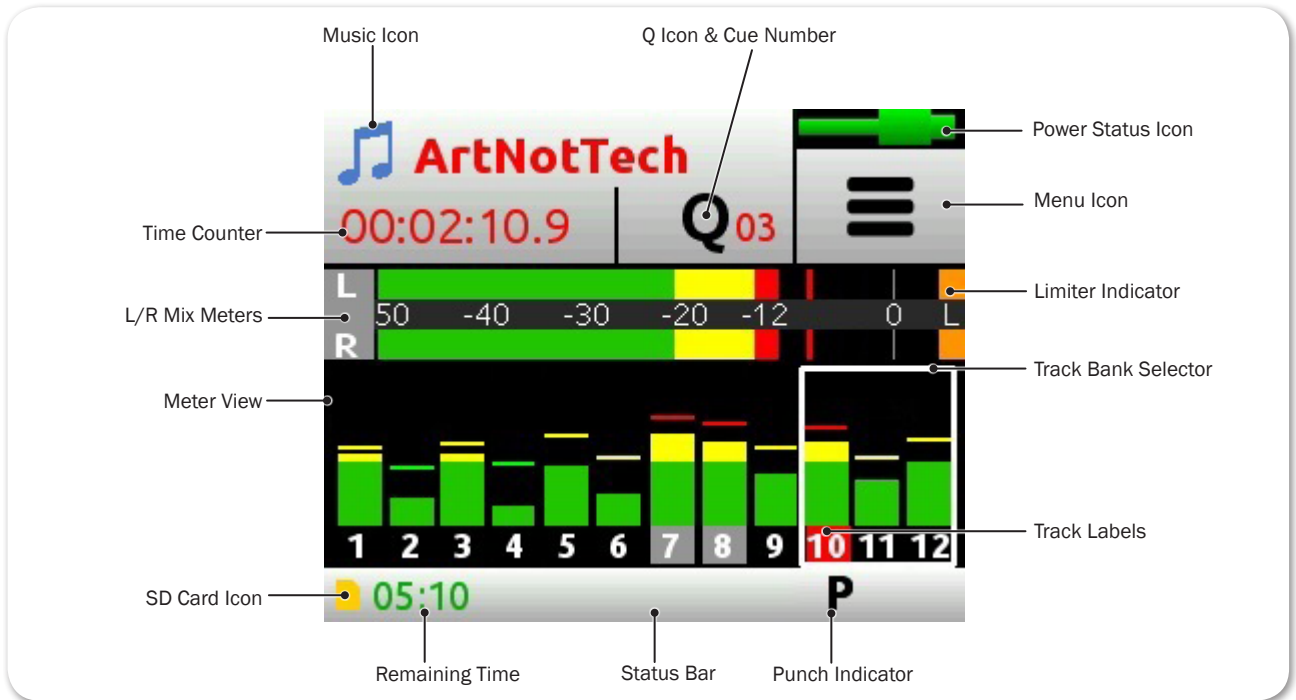

Home Screen for Music Projects

When a Music project is active, the Home screen looks different than it does for Audio projects. It appears something like this:



① *The sample image shows the Home screen on a MixPre-3, as indicated by the Track Bank Selector (white box) being around only three meters. This appears differently on the MixPre-6 and MixPre-10T.*

Here are the more obvious differences you will find on the Home screen when a Music or Audio project is active—items such as:

PROJECT	NAME	ICON	DESCRIPTION
Music	Music Notes icon		Indicates that the current project is a Music project. Tap this icon to access the Music Control menu.
Audio	Audio File icon		Indicates that the current project is an Audio project. Tap this icon to access the File List.
Both	Current file name		Displays current name of active Music project or audio file.
Both	Time counter		For Music projects, the time counter indicates the current Song Position in hh:mm:ss:tenths. All songs start at 00:00:00:0. For Audio projects, the time counter displays timecode.
Both	Q icon		Displays numerical cue markers. When playing or recording, tapping this icon sets a cue mark at current location. When stopped, tapping this icon provides access to the Cue Points menu. For more information, see Working with Cue Points .

PROJECT	NAME	ICON	DESCRIPTION
Music	Meter Views		When a Music project is active, only one meter view is available. It displays the metering for the 12 tracks and stereo mix, LR. Tap meters to switch track banks. For more information, see Track Bank Selector .
Audio			When an Audio project is active, three different meter views are available, and you can cycle through the views by tapping the meters.
Music	Status bar		Cycle status information by touching: <ul style="list-style-type: none"> • Song status: current bar position as well as Punch and Metronome, rendering status, and remaining time: In idle or record, the remaining time field displays remaining time on the SD card. In play, the field displays remaining time to the end of the song. • USB drive status: remaining space on drive, if present, and when it is actively copying (Applies to 10T only) • Date & Time
Audio			Cycle status information by touching: <ul style="list-style-type: none"> • SD card status: card/drive activity, available recording time, file duration, elapsed time, and headphone preset • USB drive status: remaining space on drive, if present, and when it is actively copying (Applies to 10T only) • Sample rate and bit depth • Date and time

Music Control Menu

The Music Control menu provides access to the project's History list, Cue list, the Render and Metronome features, and the Solo/Mute screen.

To access the Music Control menu:

▶ Tap .

Music Project History

Each recording is logged as an item (revision) in the History list. This makes it easy to “undo” to an earlier recording or “redo” to a later recording—ideal for quickly redoing a bad take or comparing different takes. The History list is in chronological order with the most recent recording at the top.

To access the History list and switch to an earlier or later recording:

1. Tap  to open the Music Control menu.
2. Tap History. The History list appears.

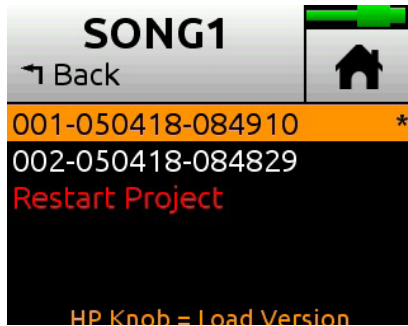

- Use the HP encoder to select a file in the list. The current recording is indicated by an asterisk (*) after its revision's file name.

① *The revision's file name is derived from the date and time the recording was finished. For example, a recording finished at 2:22 PM (14:22) on the 12th of March 2018 would have a name like this: 001-031218-142200*

To restart the current project from scratch:

- From the History list, scroll to the bottom, and select Restart Song.

This will clear all audio from the project and cannot be undone. However, the audio files themselves are not actually deleted; they remain in the project folder, which can be accessed using a computer.

Track Bank Selector

Since there are more possible tracks (twelve) in Music projects than physical Channel knobs (three on MixPre-3, four on MixPre-6, and eight on MixPre-10T), a Track Bank Selector is used to select which group of tracks you want to control with the knobs on the front panel.

The Track Bank Selector appears as a white box (or boxes) around the selected tracks. The following images show examples of different selected tracks, on MixPre-10M (left), MixPre-6M (center), and MixPre-3M (right):

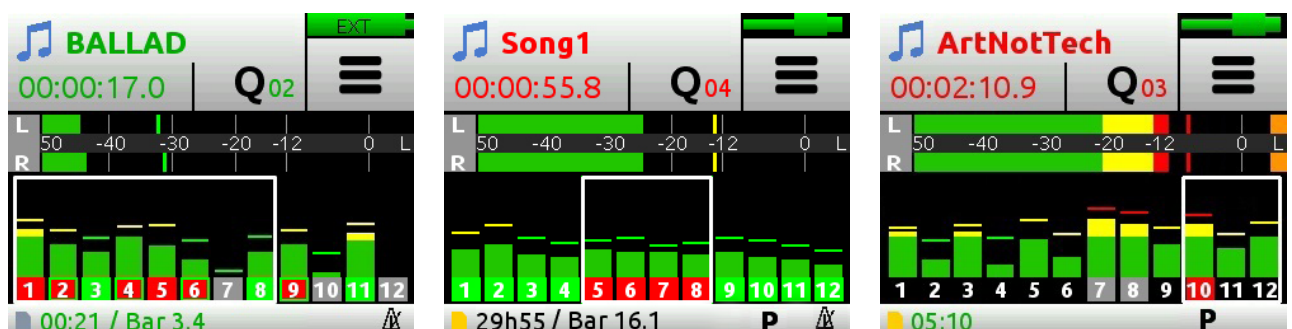

To switch track banks on a MixPre-3:

- Tap meters to cycle through each trio of tracks: 1-3, 4-6, 7-9, and 10-12.

To switch track banks on a MixPre-6:

- ▶ Tap meters to cycle through each quartet of tracks: 1-4, 5-8, and 9-12.

On the MixPre-10T, the top row of four Channel knobs always control tracks 1-4.

To switch track banks on a MixPre-10T:

- ▶ Tap meters to toggle control of bottom four knobs from tracks 5-8 to 9-12.

When a track bank is switched, rotating a Channel knob in the newly selected bank will not have an effect on level until it reaches its previously stored fader value. As soon as it reaches that value, the gain will adjust normally in relation to the knob's rotational position.

- ① *Upon switching track banks, if the knob's rotational position is not aligned with its fader value, the LEDs for that knob will illuminate with a pulsing orange light. This will stop once position and value are re-aligned.*

When adjusting the Channel knob, its fader value along with the previously stored value is shown in orange text at the top of the Home screen and Channel screens until it reaches its previously stored value, at which point it changes to black text.

For example:



In this example, the Channel knob for track 9 must be rotated clockwise, as indicated by the arrow, from its current fader value of -18dB. After it reaches the track's previously stored value of -15dB, the mix level will start to be affected.

- ① *Adjust the Channel knob a small fraction to display the stored value and arrow in orange text. The displayed arrow and stored value will inform you which way to rotate the knob.*

Channel Screens for Music Projects

To access the Channel screen:

- Push in a Channel knob.

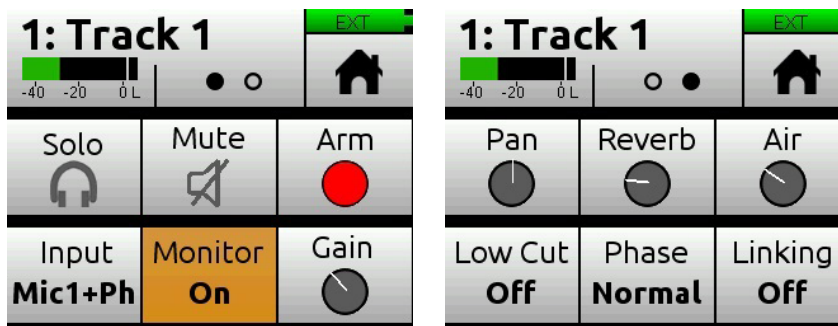

Each Channel screen provides two pages of settings—indicated by Dots icon. Tap the Dots icon to switch pages.

SETTINGS	DESCRIPTION OR LINK FOR MORE INFORMATION
Solo & Mute	Using Solo/Mute
Arm	Tap to arm a track.
Input	Setting Input Source
Monitor	Enabling Monitoring
Gain	Tap to set the trim gain (pre-fader gain) for the channel. This gain determines the signal level on the channel's individual (ISO) track.
Pan	Tap to set the position of the track in the LR stereo mix. The range has 33 positions from L16 (fully left) to C (Center) to R16 (fully right).
Reverb & (Vocal) Air	Using Reverb & Rendering a Vocal Air Effect
Low Cut	Use Low Cut to attenuate undesirable low frequencies such as mic handling noise and wind noise.
Phase	Toggling Phase Inversion
Linking	Stereo Track Linking

Setting Input Source

The MixPre-3 accepts XLR mic/line, 3.5mm (Aux In), and USB sources. The MixPre-6 and MixPre-10T accept XLR/¼-inch combo mic/line, 3.5mm (Aux In), and USB sources. You can route any of these physical inputs to any track via the Channel screen.

Because any input can be routed to any track, this reduces the need to re-plug inputs when you want to record an input to a different track. You can also select as a source the MixPre's mixer outputs (see [Bouncing](#)), a metronome click (see [Metronome](#)) or turn on Phantom power.

To route input sources for tracks:

1. Enter the Channel screen, tap Input.

The Routing screen appears similar to those shown in these examples from MixPre-10M (left), MixPre-6M (center), and MixPre-3M (right).



2. Select an input for the track. A track can only have one live input source.
3. Select Phantom if you want to turn on Phantom power for a Mic source. Phantom toggles 48V Phantom on and off. Turn Phantom on if a condenser microphone is being used.
 - ① *Notice in the previous screenshots how Phantom is only an option when a Mic source is selected.*
4. Select Click as an input for your track if you want to record the metronome click into your song. This is useful should you want to later import the song into a DAW to develop the song further. The recorded metronome will allow you to set the DAW's tempo and internal metronome so that it is perfectly aligned with the MixPre recording. For more information, see [Metronome](#).
 - ① *TIP: (10T only) If you don't have a mic handy and want to quickly record a rough scratch track of a song idea and are not too concerned about the audio quality, you can use the built-in slate mic. To select this as an input, first set Inputs>Aux In Mode to Slate Mic, and then from the (Channel > Input) Routing screen, select Slate Mic. Note that Slate Mic will only appear as an Aux In option on the Routing screen when Aux In Mode is set to Slate Mic.*

Enabling Monitoring

The Monitoring feature lets you hear the live input signal during playback. This is particularly useful when practicing along with already recorded tracks or performing live to a backing track.

To enable monitoring:

- ▶ Enter the Channel screen, tap Monitor. The button appears orange when on, except if input is off.



Using Solo/Mute

In Music projects, the MixPre offers a few different ways to mute or solo tracks.

- From each track's Channel screen, tap Mute to mute the selected track. This removes the signal from recorded tracks, mix and all outputs. When muted, its LED ring will glow red. Multiple tracks may be muted at the same time.
- From each track's Channel screen, tap Solo to hear only the selected track (pre-fade/pre-effects) in both ears of the headphone output. When a track is soloed, its LED ring will flash orange.

Like Mute, soloing is non-exclusive, meaning any number of inputs may be soloed at the same time.

You can quickly solo/mute several tracks from the Solo/Mute screen. All 12 tracks' Solos and Mutes may be viewed and set from this screen.

To solo or mute tracks from the Solo/Mute screen:

1. Tap . The Music Control screen appears.
2. Tap Solo/Mute. The Solo/Mute screen appears.

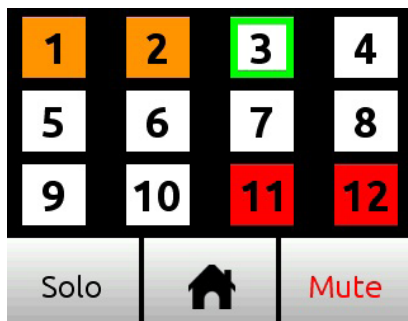

3. Do either of the following:
 - ▶ Tap either Solo or Mute and then tap track(s) to select them. Soloed channels appear orange; muted tracks appear red.
 - ▶ Use the HP encoder to highlight (green outline) a track and then tap either Solo or Mute.
4. Tap to exit the screen.

Using Reverb

Reverb sets how much reverb is added to a track in the LR mix. Only the mix is affected, not the individual recorded tracks.

① *To render the reverb effect into the individual recorded tracks, you must use the Bounce feature.*

To adjust reverb:

- ▶ From the Channel screen, tap Reverb and turn encoder. Range is Off, -50dB to 0 dB in 1 dB increments.

You can also select different reverb characteristics—such as type, decay, predelay, etc. Max sampling rate for reverb is 48 kHz.

To configure Reverb:

1. Tap .
2. Page through submenu and tap Reverb.
3. Tap any of the following settings and adjust values accordingly:

SETTING	OPTIONS
Reverb Type	Off, Plate, Hall, Room
Reverb Decay	0.1 - 5.0 seconds
Reverb Pre-Delay	0 - 40 ms
Reverb HF Damp	Off, 0-20

Rendering a Vocal Air Effect

Applying Air to a lead vocal can help it stand out in a mix. It adds a desirable 'airy' sheen to vocals.

Vocal Air sets how much "Air" is added to a track in the LR mix. The range is Off, 1%-100%. Only the mix is affected, not the individual recorded tracks.

To render the Air effect into the individual recorded tracks, you must use the Bounce feature.

① *Air can only be applied to one track at a time. If you want to apply Air to a track, but it appears grayed out on that track's Channel screen, and is therefore unavailable, you must first turn Air off on the track to which it is currently applied. If you want to add Air to multiple vocals, you can use the Bounce feature.*

Toggling Phase Inversion

Phase inversion, also known as polarity reversal, can be used to prevent signal cancellation when a source is dual-mic'd from opposite directions (e.g. overheads on a drum kit) or to compensate for incorrectly wired, balanced cables.

The Phase setting toggles Phase Inversion on and off.

To toggle a track's phase inversion:

- ▶ From the Channel screen, tap Phase.

Punching In/Out

Punching allows you to drop in and out of record on armed tracks while playing back existing unarmed tracks. Automatic punching is a commonly used technique that allows you to play along with existing audio and have the recorder automatically and seamlessly drop into and out of record at predetermined points—a cool tool for getting just the right performance. You can punch in/out on a new track or over existing tracks.

Punching in/out over existing material (known as overdubbing) replaces the existing track audio between the Record In and Out points with new audio.

To manually punch in/out:

1. Arm the tracks on which you want to punch in/out.
2. While playing back, at the desired point, press REC to punch in; the MixPre will start recording on the armed tracks. The REC control illuminates solid red.
3. Press REC again to punch out; the MixPre will stop recording but continue playing back.

To automatically punch in/out:

1. Set Record In and Record Out points to where you want the MixPre to automatically punch in and out. If a Record In or Out point is set, a 'P' is displayed in the status bar to indicate that automatic punching is enabled. See *Working with Cue Points*.
2. Use Play In and Stop Q-Points to set pre-roll and/or post-roll as necessary. Setting a few bars of pre-roll allows you to play along with existing audio to help you get up to speed and 'into the groove' before the Record In point. Use the Track 'Monitor' button to monitor either track playback or your live input during pre-roll and post-roll, depending on your preference.
3. Press REC. The transport joystick LED on the 10M (or REC button on the 3M and 6M) will illuminate green and the MixPre will start playing from the Play In point if set, or from the current playback cursor position if not set. When





the Record In point is reached, the MixPre will automatically start recording on the armed tracks and the joystick LED (or REC button) will illuminate red. Recording will continue until the Record Out point is reached (if set) at which point the MixPre will return to playback. Playback will stop when the Stop point (if set) is reached.

- ① See [Working with Cue Points](#) for more information on clearing and disabling Play In, Record In/Out, and Stop points.

Working with Cue Points

The Musician Plugin uses cue points to make it easy to locate quickly to points of interest and set up automatic punch in/out regions.

There are different types:

ICON	TYPE	DESCRIPTION
	Cue mark (01, 02, etc)	Cue marks are cue points that define a specific position of interest within a song, which may be used to “cue” or relocate to that point quickly and easily. You may have up to 99 such cues per song. For example, set a cue at the start of a verse or chorus. You can name cues for easy identification. Cue marks may also be set as Play In, Record In, Record Out, or Stop points.
	Play In	Defines when playback begins. Typically used as pre-roll before punch in (Record In).
	Record In	Defines when automatic recording begins (the start of the Punch In/Out region).
	Record Out	Defines when automatic recording ends (the end of the Punch In/Out region).
	Stop	Defines when playback stops. Typically used as post-roll after a punch out (Record Out).

To add Play In and Record In/Out and Stop cue points:

1. While stopped, tap the Q icon  , located at the top of the Home screen. The Cue Points menu appears.



2. Tap each button (according to icons shown in previous table) to add that cue point at current song position. This may be done while stopped, paused, or during playback.



- ① *It is not possible to place an In point after an Out point. It is also not possible to have more than one In or Out point of each type (Play or Record).*

Alternatively, you can create cue marks and set them as Play In, Record In/Out, or Stop points from the Cue-List.

To set a cue marks as a Play In, Record In/Out, or Stop point:

1. From the Cue List, select a cue.
2. Tap Set As.
3. Tap Play In, Record In, Record Out, or Stop to set the selected cue mark as an In/Out point for recording or playback.

Previewing cue marks:

Previewing plays a few seconds of a project from a cue mark. If the cue mark is slightly late or early, use the move function to fine tune its position. Previewing cue marks is available only within the Musician Plugin.

To preview cue marks:

- ▶ Select one in the Cue List and press Play.

To jump between cue marks:

- ▶ While playing or paused, press in and hold the Play button, and then turn the HP encoder to jump to the next or previous cue mark.

Bouncing

With the Musician plugin, the MixPre offers up to 12 tracks which is enough for many situations. For example, four for drums, one for bass, two for vocals, two for guitars, two for keyboards plus a spare!

However, sometimes you may want to add more layers. Bouncing, sometimes known as Ping-Ponging, is a technique dating back to the days of the Beatles and Beach Boys that allows you to combine multiple tracks into just one or two thereby freeing up tracks for further overdubbing. It is also used to simplify mixdowns by grouping multiple tracks, or burning in reverb or air effects into an ISO track.

In the MixPre, the bounce mix is derived from the LR mix.

To bounce:

1. Decide to which track(s) you want to bounce. Let's call these the destination tracks.
2. In the destination tracks' channel screens, set Input to MixL, MixR, or both. Your choice will depend on whether you want to do a mono, stereo, or dual mono bounce. For instance, if you are doing a stereo bounce to tracks 1 and 2, set track 1 to MixL and track 2 to MixR. If you are doing a mono bounce to track 3, set track 3 to both MixL and MixR.

① Any track that is set to MixL or MixR is removed from the LR mix to prevent feedback. You can adjust the level of the recorded bounce using the LR gain control - tap the L(left) mix meter in the home screen to quickly access LR gain.
3. Decide which track or tracks you want to bounce from. Let's call these the source tracks.
4. Mute all tracks except the source and destination tracks.
5. Disarm all tracks except for the destination tracks.
6. Set the source track levels, pans, reverb and air effects as required. Effects are burned in to the destination track(s).
7. You are now ready to bounce.
8. Manually start recording or use auto-punch to begin bouncing from the required location. As with normal recording, bouncing is a real-time process where you can dynamically adjust the source track levels, pans, and effects.
9. Press stop to finish the bounce at any time.
10. Disarm and unroute MixL and MixR from the destination tracks.
11. To hear your bounce, start playback from roughly where the bounce started. Adjust mix level, pan, reverb and air accordingly.

You may want to mute or clear the original source tracks so that you can hear your bounce in isolation.

To clear a track:

1. Access its Channel screen.
2. Tap Input, and then tap Clear.
Examples: MixPre-3 (left) & MixPre-10T (right)



Clear is only displayed if the track contains audio.

Clearing tracks removes them from the project entirely. The files still exist, but they can only be accessed from a computer.

3. Tap Yes to confirm removal of track audio from the project.

Metronome

The metronome is an audible click that may be used to help you perform in time while recording and also provide a count-in so that you know when to start playing. The first beat of the bar is represented by a higher pitched click than the other beats of the bar. The metronome click is summed with the LR mix and as such can be heard when the headphones or outputs are set to LR.

The metronome may also be recorded to a track. Select Click in a track's Input screen.

To set up the metronome:

1. Tap .
2. Tap Metronome, then do any or all of the following:

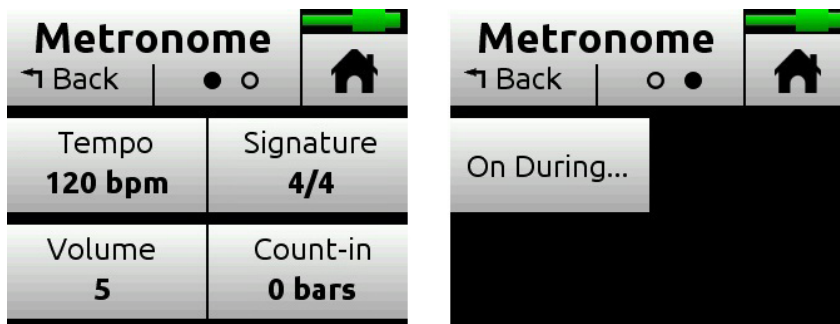

① *You will hear a preview of the metronome while in this screen.*

- ▶ Tap Signature and set the beat (time signature) for the song. Options include: 1/4, 2/4, 3/4, 4/4, 5/4, 6/4, 7/4, 8/4, 6/8, 7/8, 9/8.
- ▶ Tap Tempo and set the song tempo (metronome click rate) by tapping the arrows or using the HP encoder to adjust the tempo bpm (beats per minute) value. Range is 40 to 240 bpm.
- ▶ Tap Volume to set the volume of the metronome click.

- ▶ Tap Count-in to set the number of count-in bars you want before recording starts. Range is 0 to 8 bars.
- ▶ Tap On During... to set when the metronome is active. Options include: Record, Play, or Count-in.

To enable the metronome:

- ▶ From the Music Control menu, tap the  Metronome button. The Metronome icon will illuminate orange when active.

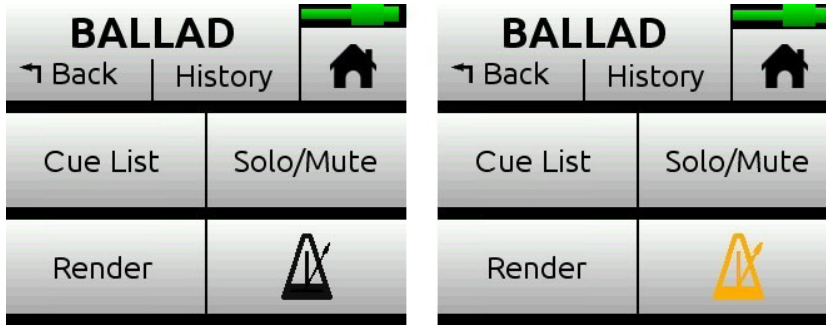

① *The Metronome button will be disabled (appearing grayed out but with an orange icon) whenever Click is assigned as a track's input source.*

Record Settings

With the Musician plugin, the Record submenu provides access to the settings detailed in the following table:

SUB-MENU	DESCRIPTION	OPTIONS
L&R Gain	Sets the gain for the LR mix.	<ul style="list-style-type: none"> • -30 - 0 dB (1 dB increment)
	<p>① <i>Tip: You can quickly access L&R Gain by tapping the L (left) horizontal meter on the Home screen.</i></p>	
AAC Quality	Sets the quality value for AAC rendering. For more information, see <i>Scroll to and select the an Audio project folder first, then choose a .wav file to import it from within the folder..</i>	<ul style="list-style-type: none"> • 32 kbps • 64 kbps • 128 kbps • 192 kbps • 256 kbps

To access the Record submenu:

- ▶ Tap , then Record.

Sharing Projects

Sharing projects is as easy as transferring to a computer and uploading to colleagues via the internet or simply handing them an SD card or (on 10T only) a USB thumbdrive.

There are multiple ways to share a project:

- Copy Project Folder - ideal for collaborating with other MixPre users. They can load the whole project from an SD card and continue working from

where you left off.

- ① *Project compatibility is model-specific. For instance, a music project created using a MixPre-10M is compatible with another MixPre-10M or any MixPre-10T with the Musician plugin.*
- Render a Wav or AAC Stereo File - ideal for sharing your latest mix with friends and band members
- ① *An AAC file is like an .mp3 audio file, except it has better quality for similar bit rates.*
- Render all individual tracks (also known as ISOs) as monophonic files - ideal for importing into a DAW for further production.

To render a project:

1. Tap .

2. Tap Render.



3. Select a format. Options include:

- Wav Stereo - performs a real-time render of the LR mix to an uncompressed 2ch stereo wav file. All track level, pan, mute, reverb and air adjustments made during rendering are reflected in the resulting stereo wav file.
- AAC Stereo - performs a real-time render of the LR mix to a compressed 2ch stereo AAC file. AAC files are much smaller in size than a WAV file and so are faster to share over the internet. All track level, pan, mute, reverb and air adjustments made during rendering are reflected in the resulting AAC file.
- ① *The bit rate for AAC rendering is set via Main Menu > Record > AAC Quality. Options for AAC bit rates are: 32, 64, 128, 192, or 256 kbps. The higher the number, the better the quality.*
- Wav All Isos - performs a real-time render of all isolated (individual) tracks each to their own monophonic wav file. This is the ideal option for importing all tracks into a DAW. Just drag them all to zero on your DAW's timeline to sync all of them up perfectly.

MixPre Ambisonics Plugin

Capture 360° spatial audio anywhere with the Ambisonics Plugin and your MixPre-6 or MixPre-10T. The Ambisonics Plugin, available for free from the Sound Devices Store, brings ambisonic and binaural recording, monitoring, and playback to your MixPre running v3.00 or higher.



Ambisonics Plugin Key Features:

- Supports the Sennheiser AMBEO VR Mic (Ambisonics A-Format)
- Record, playback, and monitor Ambisonics A-Format and B-Format (FuMa and AmbiX)
- Record, playback, and monitor ambisonics decoded to binaural and stereo
- Converts from A-Format to B-Format
- Up to 192 kHz sample rate
- Supports different mic orientations (Up, Down, Endfire)
- Simultaneously record ambisonics, stereo, and binaural WAV files
- Automatic 4-channel gain linking for single knob gain control

① *Binaural is not supported at 96 kHz sample rate or higher.*

An ambisonics microphone most commonly consists of four cardioid or supercardioid microphone capsules positioned in a tetrahedral arrangement. This makes it possible for a full sphere of sound to be captured from a single point in space. This four capsule approach is known as first order ambisonics. There are also second order ambisonic microphones which are less common

and use a greater number of capsules to achieve more accurate spatial resolution.

① *The MixPre-6 and -10T support first order ambisonic microphones only.*

There are two ambisonics formats, A-Format and B-Format.

A-Format refers to the raw, unprocessed signals coming directly from the four mic capsules.

B-Format has become the most widely-used method for representing the spherical sound space. This is primarily because B-Format allows a 3D sound space to be decoded into any current or future surround format.

The Sennheiser AMBEO mic and most other ambisonic mics output A-Format, so it is necessary to convert to B-Format before surround post production can begin. Because the MixPre-6 and -10T incorporate built-in A- to B-Format conversion, you don't need to use a DAW. Some microphones, such as the Soundfield ST450 MKII, output B-Format directly and eliminate the need to convert at all.

B-Format is represented by 4-channels, W, X, Y, Z where:

- W = Sum of all signals from all directions (like an omnidirectional mic)
- X = Front minus rear signal (like a horizontal front/rear facing figure of 8 mic)
- Y = Left minus right (like a horizontal left/right facing figure of 8 mic)
- Z = Up minus down (like a vertical up/down facing figure of 8 mic)

Additionally, B-Format comes in two versions, FuMa and AmbiX.

In essence, the distinction is a different ordering of the W,X,Y, and Z channels:

- FuMa = W,X,Y,Z
- AmbiX = W,Y,Z,X

MixPre supports both versions, and you can record both at the same time.

When Ambisonics Mode is enabled, the MixPre automatically links channels 1-4 so that all channel 1-4 gains are matched and channel knob 1 adjusts their gain equally. This ensures the captured sound space will be centered.

Installing and Activating the Plugin

The Ambisonics Plugin, which may be downloaded for free from the Sound Devices online store (<http://store.sounddevices.com>), is required for recording ambisonics.

To install and activate the plugin:

1. Download the license—a .LIC file—and move to an SD card.

① *The Ambisonics Plugin is licensed to a MixPre-6 or -10T recorder and its serial*

number, so it cannot be transferred to another device or to multiple MixPre devices.

2. Insert the SD card into the MixPre and turn on the recorder.
3. Tap .
4. Tap System > Plugins.
5. Tap Apply Plugins. This installs the license, activates the plugin, and reboots the device.

Monitoring Ambisonics with Headphones

To monitor ambisonics using headphones, the four channels of the B-Format (W,X,Y,Z) must be decoded to two channels. With the MixPre, you can decode to stereo or binaural. Stereo provides a standard 2D, left/center/right representation of the 3D sound space. Binaural, on the other hand, allows you to hear the full 3D sound space (left/right, forward/back, up/down) using any pair of headphones.

The ability to monitor 3D space binaurally can help you determine optimal mic placement at the time of capture on location, thus reducing the likelihood of placement and orientation mistakes.

The MixPre also provides the ability to record and playback stereo/binaural.

To set up ambisonics:

1. Ensure the Ambisonics Plugin is installed and activated on your MixPre. See [Installing and Activating the Plugin](#) for more details.
2. Connect the Sennheiser AMBEO Microphone to the MixPre-6 or -10T. Ensure that the AMBEO XLR cables are connected in the correct order, such as:
 - Yellow XLR 1 to MixPre XLR input 1
 - Red XLR 2 to MixPre XLR input 2
 - Blue XLR 3 to MixPre XLR input 3
 - Green XLR 4 to MixPre XLR input 4
3. Ensure the MixPre is in Advanced Mode or Custom Mode with Channel and Headphone set to Advanced.
4. Enable Ambisonics Mode: Go to Menu > Inputs > Ambisonics > Mode and set to the required Ambisonics Mode.



When Ambisonics Mode is enabled, input channels 5-6 (MixPre-6) and 5-10 (MixPre-10T) are no longer available and input channels 1-4 are automatically linked so that channel knob 1 becomes the master gain control for those four channels.

The following table describes the various Ambisonics Modes available:

AMBISONICS MODE	DESCRIPTION
Off	<ul style="list-style-type: none"> Ambisonics Mode is disabled.
A->B (AmbiX)	<ul style="list-style-type: none"> The incoming A-Format is converted to AmbiX B-Format (W,Y,Z,X) for recording on tracks 1-4. Recording results in a single 4ch poly wav.
A->B (FuMa)	<ul style="list-style-type: none"> The incoming A-Format is converted to FuMa B-Format (W,X,Y,Z) for recording on tracks 1-4. Recording results in a single 4ch poly wav.
A->B (AmbiX+FuMa)*	<ul style="list-style-type: none"> The incoming A-Format is converted to AmbiX B-Format (W,Y,Z,X) for recording on tracks 1-4 plus FuMa B-Format (W,X,Y,Z) on tracks 5-8. Channel knob 1 controls the level going to all 8 tracks. Recording results in two separate 4ch poly wavs.
A (Direct)	<ul style="list-style-type: none"> The incoming A-Format is routed directly to tracks 1-4 without any processing. Use this if you intend to do conversion to B-Format in post. Recording results in a single 4ch poly wav.
A (Direct) + AmbiX*	<ul style="list-style-type: none"> The incoming A-Format is routed directly to tracks 1-4 without any processing and also converted to AmbiX B-Format (W,Y,Z,X) for recording on tracks 5-8. Channel knob 1 controls the level going to all 8 tracks. Recording results in two separate 4ch poly wavs.
A (Direct) + FuMa*	<ul style="list-style-type: none"> The incoming A-Format is routed directly to tracks 1-4 without any processing and also converted to FuMa B-Format (W,X,Y,Z) for recording on tracks 5-8. Channel knob 1 controls the level going to all 8 tracks. Recording results in two separate 4ch poly wavs.

AMBISONICS MODE	DESCRIPTION
B (AmbiX) or B (FuMa)	<ul style="list-style-type: none"> The incoming B-Format is routed directly to tracks 1-4 without any processing. Use this if the microphone source is already in B-Format e.g. Soundfield ST450 MKII. Recording results in a single 4ch poly wav.

* Mode applies to MixPre-10T only

① *Ambisonics Mode is not available for Music Projects.*

- In the Ambisonics Menu > Inputs > Ambisonics > Mic Position, set the correct Mic Position to match the physical orientation of the mic.



Select from Up, Down, or Endfire. It is essential that this setting is correct to ensure the sound space is mapped correctly.

- In Channel Screen 1, set Phantom to 48V.
- Adjust channel fader 1 to set the desired signal level.
- Set the HP Preset (top left corner of Main Menu) to LR Stereo or Binaural to hear the decoded ambisonics signal as stereo or binaural respectively.
- To record, go to channel screen 1 and tap Arm, then press record.

Recording

The MixPre is capable of simultaneously recording various combinations of Ambisonics A-Format, B-Format, Stereo and Binaural wav files. This powerful feature allows you to simultaneously deliver multiple formats depending on production needs.

① *Files that are recorded simultaneously have the same timecode stamp and metadata and are also associated as a family using the iXML File Set Index. Tip: Use Wave Agent to view this metadata.*

Which files are recorded depends on three things:

- The MixPre model.
 - The MixPre-6 can record a maximum of 8 tracks and so is restricted to recording a single 4ch ambisonic wav file plus a stereo wav file and a binaural wav file.
 - The MixPre-10T can record a maximum of 12 tracks and so can record two 4ch ambisonic wav files plus a stereo wav file and a binaural wav file.
- Ambisonics Mode. This mode determines which ambisonics formats are recorded and whether one or two 4ch wav files are recorded. See the Ambisonics Mode table above.
- Rec L,R and Rec Binaural On/Off settings in the Record menu. These settings determine whether stereo and/or binaural 2ch wav files are recorded. When set to On, they are recorded.

Each type of file is identified by a filename suffix. For example:

AMBEO-001_A_FMT.wav (A-Format)

AMBEO-001_FUMA.wav (FuMa B-Format)

AMBEO-001_AMBIX.wav (AmbiX B-Format)

AMBEO-001_LR.wav (Decoded stereo)

AMBEO-001_BIN.wav (Decoded binaural)

Appendix A

Basic/Advanced Mode Differences

SCREEN	SUB-MENU	BASIC MODE	ADVANCED MODE
Channel	Solo	-	✓
Channel	Mute	-	✓
Channel	Arm	-	✓
Channel	Gain	-	✓
Channel	Pan	L, C, R	Continuously Variable
Channel	Input	✓	✓
Channel	Phantom	✓	✓
Channel	Low Cut	Fixed 80 Hz	40, 80, 120, 160 Hz
Channel	Phase	-	Normal/Invert
Channel	Delay	-	0 - 30 ms
Channel	Linking	-	Stereo, MidSide
Menu	Presets	✓	✓
Menu	Project	✓	✓
Menu	Inputs (Aux In)	Mic, Line, Off	Mic, Line, Camera, Timecode, Off
Menu	Outputs	-	Stereo out L/R source select, Stereo out gain
Menu	Timecode	✓	✓
Menu	Tone	On/Off	On/Off, Continuous/Left Identify/Tone Level
Menu	Record	Pre-roll Time, Rec Trigger, Record Bells	LR Linking, L/R Gain, Sample Rate, Bit Depth, Pre-roll Time, Rec Trigger, Remix, Record Bells
Menu	SD Card	✓	✓
Menu	System	✓	✓
Menu	System > Limiters	Always On	On/Off
Menu	Power	✓	✓

System Settings

PAGE	SUB-MENU	DESCRIPTION
1	Mode	Lets you switch the operating mode between Basic, Advanced and Custom.
1	USB-C	Switches between Audio and Power Only USB modes.
1	USB Audio	Lets you switch between Normal and Stereo Out modes. When set to Stereo Out, the USB Audio interface outputs only two channels and does not receive USB audio from a computer. See Adjusting USB Audio Output for more information.
1	File Transfer	Lets you transfer files between the MixPre and a host computer.
2	Limiters	Lets you turn limiters on/off (available only in Advanced or Custom modes).
2	Bluetooth	Switches Bluetooth Smart on/off.
2	Wingman Password	Lets you set a password that would be required when connecting to the MixPre-6 with the Wingman app.
2	Brightness	Lets you independently adjust the brightness of the touch screen and the ring LEDs.
3	Date/Time	Lets you set current date/time and format.
3	Version	Provides the type of model, current firmware version, and serial number.
3	Regulatory	Provides full Federal Communications Commission (FCC) compliance information specific to MixPre-6.
3	Update Firmware	Lets you update the MixPre firmware from a file on the SD card. The latest MixPre firmware can be downloaded from the Sound Devices website: www.sounddevices.com/support/downloads
4	Plugins	Lets you view and apply plugins.

Specifications

Specifications are subject to change without prior notice.

For the latest information available on all Sound Devices products, visit our website at: www.sounddevices.com.

Audio Inputs

NAME	DESCRIPTION
Frequency Response	10Hz to 80kHz +/- 0.5dB re 1kHz @ 192kHz sample rate
Total Harmonic Distortion (THD)	0.005% max (@1kHz, 22-22kHz BW, gain=20dB, -10dBu in)
Equivalent Input Noise (EIN)	-130dBV (-128dBu) max (A-weighting, gain=76dB, 150 ohm source impedance)
Inputs	<ul style="list-style-type: none">• Mic: XLR active-balanced; 4k input Z• Line: XLR active-balanced; 4k input Z• Line: ¼-inch TRS active-balanced; 4k input Z• Aux/Mic in: 3.5mm TRS, 2-channel unbalanced; 100k input Z• USB Audio: 4 channels• All inputs fully RF-filtered and overload protected.
Gain	<ul style="list-style-type: none">• Mic input: +6dB to +76dB• Line input: -20dB to +30dB• Fader: -inf to +20dB• Headphone: -inf to +20dB• Total, Mic-to-recording (max): +96dB• Aux In (Mic): +10dB to +40dB• Aux In (Line): -10dB to +20dB• Total Aux Gain including Fader, Mic-to-recording: +60dB
ADC Dynamic Range	32 bit precision; 120dB dynamic range min (A-weighted, gain=10dB, fader=0dB)
Maximum Input Level	<ul style="list-style-type: none">• Mic XLR: +14dBu (limiters on or off)• Line XLR/¼-inch: +28dBu (limiters on or off)• Aux In (Mic): -10dBu• Aux In (Line): +10dBu
Limiters	<ul style="list-style-type: none">• Limiter at all gain stages, range > 40dB.• First stage analog, subsequent stages digital
Low Cut Filters	40Hz to 160Hz (adjustable), 18 dB/oct. First stage analog, subsequent stages digital
Microphone Powering	<ul style="list-style-type: none">• Mic XLRs: 48V via 6.8k resistors, 10mA each• Mic 3.5mm: 3V @ 3k source Z

Audio Outputs

NAME	DESCRIPTION
Stereo Out	3.5mm TRS stereo unbalanced, 500 ohm output Z, +7.8dBu max output level
DAC feeding Stereo Out, Headphone Out	32 bit precision; 115dB dynamic range (A-weighted)
Headphone Out	3.5 mm TRS stereo unbalanced, 300 mW per side, for use with any impedance headphones
Output Limiters	Digital

Recorder

NAME	DESCRIPTION
Maximum Record Tracks	8 tracks (stereo mix + 6 ISOs)
Sampling Frequency	<ul style="list-style-type: none"> • 44.1 kHz • 48 kHz • 96 kHz • 192 kHz
Bit Depth	16, 24
Media Type	<ul style="list-style-type: none"> • Secure Digital Extended Capacity (SDXC) • Secure Digital High Capacity (SDHC) • Secure Digital (SD)
Maximum Storage Size	512 GB (SDXC)
Card Format	• FAT32 formatted (32GB or less), exFAT for (>32GB), on-board memory card formatting
File Type	• WAV (Broadcast Wave File format), with embedded timecode stamp and metadata

USB

NAME	DESCRIPTION
Audio Interface (USB-C)	8-in/4-out; 44.1 to 96 kHz; 16/24-bit; Class compliant USB 2.0 high speed or ASIO (supplied)
Mass Storage (USB-C)	USB 2.0 high speed
Keyboard (USB-A)	Text entry and control

Touch Screen

NAME	DESCRIPTION
Display	1.6-inch, color, sunlight-viewable IPS LCD
Resolution	320x240

Timecode

NAME	DESCRIPTION
Modes	<ul style="list-style-type: none"> • Time of Day (file stamped w/current ToD) • LTC Input (file stamped w/incoming LTC on Aux 3.5mm) • HDMI TC (file stamped w/incoming TC from HDMI & sample clock slaved from HDMI sample clock. Only works on specific cameras that support HDMI TC)
Frame Rates	Auto detects (fps): <ul style="list-style-type: none"> • 23.98 (same as 23.976) • 24 • 25 • 29.97DF • 29.97ND • 30
HDMI TC In	From cameras that output timecode over HDMI

Remote Control

NAME	DESCRIPTION
Bluetooth Smart	Wireless control using Wingman app
HDMI	Auto-record start/stop trigger from cameras that output record flag over HDMI
Timecode	Auto-record start/stop trigger via Aux In timecode

Power

NAME	DESCRIPTION
AA Batteries	<ul style="list-style-type: none"> • 4x AA sled • 8x AA sled • NiMH recommended
L-Mount Batteries	MX-LMount: L-Mount sled for 2x hot-swappable, Li-Ion batteries
From Computer	Bus-powered via USB-C port. Use either: <ul style="list-style-type: none"> • USB-C to USB-C cable (optional) • MX-USBY: USB-C to dual USB-A Y-cable (included)
AC Adapter	MX-PSU: 15W PSU w/USB-C connector; includes wall adapter plugs for US, UK, Australia, and Europe

Environmental

NAME	DESCRIPTION
Operation and Storage	<ul style="list-style-type: none"> • Operating: -20° C to 60° C • Storage: -40° C to 85° C • 0 to 90% relative humidity (non-condensing)

Dimensions and Weight

NAME	DESCRIPTION
Size (H x W x D)	<ul style="list-style-type: none">• 1.4 in x 6.53 in x 4.65 in• 36 mm x 166 mm x 118 mm
Weight	<ul style="list-style-type: none">• 19.9 oz (unpackaged, without batteries)• 0.56 kg (unpackaged, without batteries)



Glossary of Terms

- ARM**
Enables a track for recording
- GAIN**
The ratio of output to input level. Gain is relevant at any point in the audio signal path where there is a stage of amplification, such as preamplifier, mixer, output, headphones.
- PAN**
The pan controls the spread of a monaural signal in a stereo or multi-channel sound field - it is critical to the makeup of the stereo image. Panning adds space in a mix through panning the sounds center, left and right.
- PHANTOM**
Phantom power is DC electric power transmitted through a microphone cable to operate microphones that contain active electronic circuitry. Most often used as a power source for condenser microphones, though many active direct boxes also use it. The MixPre incorporates P48 +48VDC phantom powering, switchable on each microphone input.
- Low Cut**
An active filter that removes frequencies below a specific point. The MixPre incorporates 80, 120, 160, 200 and 240Hz options with a rolloff of 18dB per octave, switchable on each microphone input.



Software License

End-user license agreement for Sound Devices MixPre Series Software / Embedded Firmware

Important Read carefully:

This Sound Devices, LLC end-user license agreement ("EULA") is a legal agreement between you (either an individual or a single entity) and Sound Devices, LLC for the Sound Devices, LLC software product identified above, which includes computer software, embedded firmware, and may include associated media, printed materials, and "online" or electronic documentation ("SOFTWARE PRODUCT"). By using, installing, or copying the SOFTWARE PRODUCT, you agree to be bound by the terms of this EULA. If you do not agree to the terms of this EULA, do not use or install the SOFTWARE PRODUCT.

Software Product License

The SOFTWARE PRODUCT is protected by copyright laws and international copyright treaties, as well as other intellectual property laws and treaties. The SOFTWARE PRODUCT is licensed, not sold.

Grant of license. This EULA grants you the following limited, non-exclusive rights: In consideration of payment of the licensee fee, Sound Devices, LLC, as licensor, grants to you, the licensee, a non-exclusive right to use this copy of a Sound Devices, LLC software program (hereinafter the "SOFTWARE") on a single product and/or computer. All rights not expressly granted to licensee are reserved to Sound Devices, LLC.

Software ownership. As the licensee, you own the hardware on which the SOFTWARE is recorded or fixed. Sound Devices, LLC shall retain full and complete title to the SOFTWARE and all subsequent copies of the SOFTWARE, regardless of the media or form on or in which the original copies may exist. The license is not a sale of the original SOFTWARE.

Copyright

All rights, title, and copyrights in and to the SOFTWARE PRODUCT (including, but not limited to, any images, photographs, animations, video, audio, music, text, and "applets" incorporated into the SOFTWARE PRODUCT) and any copies of the SOFTWARE PRODUCT are owned by Sound Devices, LLC or its suppliers. The SOFTWARE PRODUCT is protected by copyright laws and international treaty provisions. Therefore, you must treat the SOFTWARE PRODUCT like any other copyrighted material, except that you may make copies as only provided below. You may not copy the printed materials accompanying the SOFTWARE PRODUCT.

Restrictions on use. Licensee may not distribute copies of the SOFTWARE or accompanying materials to others. Licensee may not modify, adapt, translate, reverse engineer, decompile, disassemble, or create derivative works based on the SOFTWARE or its accompanying printed or written materials.

Transfer restrictions. Licensee shall not assign, rent, lease, sell, sublicense, or otherwise transfer the SOFTWARE to another party without prior written consent of Sound Devices, LLC. Any party authorized by Sound Devices, LLC to receive the SOFTWARE must agree to be bound by the terms and conditions of this agreement.

Termination

Without prejudice to any other rights, Sound Devices, LLC may terminate this EULA if you fail to comply with the terms and conditions of this EULA. In such event, you must destroy all copies of the SOFTWARE PRODUCT and all of its component parts.

Limited Warranty

No warranties. Sound Devices, LLC expressly disclaims any warranty for the SOFTWARE PRODUCT. The SOFTWARE PRODUCT and any related documentation is provided "as is" without warranty or condition of any kind, either express or implied, including, without limitation, the implied warranties and conditions of merchantability, fitness for a particular purpose, or non-infringement. The entire risk arising out of use or performance of the SOFTWARE PRODUCT remains with you.

No liability for damages. In no event shall Sound Devices, LLC or its suppliers be liable for any damages whatsoever (including, without limitation, damages for loss of business profits, business interruption, loss of business information, or any other pecuniary loss) arising out of the use of or inability to use this Sound

Devices, LLC product, even if Sound Devices, LLC has been advised of the possibility of such damages. In any case, Sound Devices, LLC's entire liability under any provision of this evaluation license shall be limited to the greater of the amount actually paid by you for the SOFTWARE PRODUCT or U.S. \$5.00. Because some states/jurisdictions do not allow the exclusion or limitation of liability for consequential or incidental damages, the above limitation may not apply to you.

Governing Law

This agreement and limited warranty are governed by the laws of the state of Wisconsin.

FCC & ISED Compliance Statements



This device complies with part 15 of the FCC Rules. Operation is subject to the following two conditions: (1) This device may not cause harmful interference, and (2) this device must accept any interference received, including interference that may cause undesired operation. FCC Part 15.19 (a) (3)

Changes or modifications not expressly approved by the party responsible for compliance could void the user's authority to operate the equipment.

FCC Interference Statement

This equipment has been tested and found to comply with the limits for a Class B digital device, pursuant to part 15 of the FCC Rules. These limits are designed to provide reasonable protection against harmful interference in a residential installation. This equipment generates, uses and can radiate radio frequency energy and, if not installed and used in accordance with the instructions, may cause harmful interference to radio communications. However, there is no guarantee that interference will not occur in a particular installation. If this equipment does cause harmful interference to radio or television reception, which can be determined by turning the equipment off and on, the user is encouraged to try to correct the interference by one or more of the following measures:

- Reorient or relocate the receiving antenna.
- Increase the separation between the equipment and receiver.
- Connect the equipment into an outlet on a circuit different from that to which the receiver is connected.
- Consult the dealer or an experienced radio/TV technician for help.

FCC & ISED User Statement

This device complies with FCC and ISED RF Exposure SAR limits exposure limits for general population / uncontrolled exposure.

Cet appareil est conforme à la norme FCC et USED RF Exposure SAR limite les limites d'exposition pour la population générale / l'exposition incontrôlée.

This Device complies with Industry Canada License-exempt RSS standard(s). Operation is subject to the following two conditions: 1) this device may not cause interference, and 2) this device must accept any interference, including interference that may cause undesired operation of the device.

Cet appareil est conforme avec Industrie Canada, exempts de licence standard RSS (s). Son fonctionnement est soumis aux deux conditions suivantes: 1) ce dispositif ne peut pas causer d'interférences, et 2) ce dispositif doit accepter toute interférence, y compris les interférences qui peuvent causer un mauvais fonctionnement de l'appareil.



Sound Devices, LLC
E7556 Road 23 and 33
Reedsburg, Wisconsin 53959
USA

Phone: +1 (608) 524-0625
Fax: +1 (608) 524-0655

Customer Support

Toll Free: (800) 505-0625

Email: support@sounddevices.com
<http://www.sounddevices.com/support>
<http://forum.sounddevices.com>

Product Information

For more information about products and accessories, visit us on the web at www.sounddevices.com.

Report Documentation Error

Email: techpubs@sounddevices.com

