

INVO TONE

USER'S MANUAL

AS SERIES SPEAKER ENCLOSURES ACTIVE MODELS

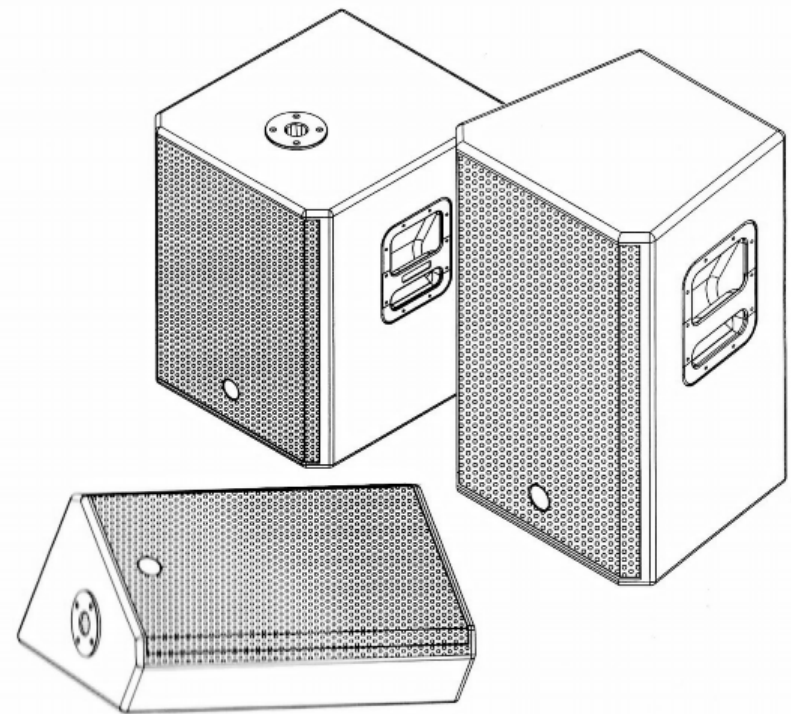

IMPORTANT SAFETY INSTRUCTION



TO REDUCE THE RISK OF ELECTRIC SHOCK PLEASE DO NOT REMOVE THE COVER OR THE BACK PANEL OF THIS EQUIPMENT. THERE ARE NO PARTS NEEDED BY USER INSIDE THE EQUIPMENT. FOR SERVICE, PLEASE CONTACT QUALIFIED SERVICE CENTERS.

This symbol, wherever used, alerts you to the presence of un-insulated and dangerous voltages within the product enclosure. These are voltages that may be sufficient to constitute the risk of electric shock or death.

This symbol, wherever used, alerts you to important operating and maintenance instructions. Please read.

⊕ Protective Ground Terminal
 ~ AC mains (Alternating Current)
 ⚡ Hazardous Live Terminal

ON: Denotes the product is turned on.

OFF: Denotes the product is turned off.

CAUTION

Describes precautions that should be observed to prevent damage to the product.

1. Read this Manual carefully before operation.
2. Keep this Manual in a safe place.
3. Be aware of all warnings reported with this symbol.
4. Keep this Equipment away from water and moisture.
5. Clean it only with dry cloth. Do not use solvent or other chemicals.
6. Do not damp or cover any cooling opening. Install the equipment only in accordance with the Manufacturer's instructions.
7. Power Cords are designed for your safety. Do not remove Ground connections! If the plug does not fit your AC outlet, seek advice from a qualified electrician. Protect the power cord and plug from any physical stress to avoid risk of electric shock. Do not place heavy objects on the power cord. This could cause electric shock or fire.
8. Unplug this equipment when unused for long periods of time or during a storm.
9. Refer all service to qualified service personnel only. Do not perform any servicing other than those instructions contained within the User's Manual.
10. To prevent fire and damage to the product, use only the recommended fuse type as indicated in this manual. Do not short-circuit the fuse holder. Before replacing the fuse, make sure that the product is OFF and disconnected from the AC outlet.

WARNING

To reduce the risk of electric shock and fire, do not expose this equipment to moisture or rain.



Dispose of this product should not be placed in municipal waste and should be separate collection.

11. Move this Equipment only with a cart, stand, tripod, or bracket, specified by the manufacturer, or sold with the Equipment. When a cart is used, use caution when moving the cart / equipment combination to avoid possible injury from tip-over.

12. Permanent hearing loss may be caused by exposure to extremely high noise levels. The US. Government's Occupational Safety and Health Administration (OSHA) has specified the permissible exposure to noise level. These are shown in the following chart:

HOURS X DAY	SPL	EXAMPLE
8	90	Small gig
6	92	train
4	95	Subway train
3	97	High level desktop monitors
2	100	Classic music concert
1,5	102	
1	105	
0,5	110	
0,25 or less	115	Rock concert

According to OSHA, an exposure to high SPL in excess of these limits may result in the loss of heat. To avoid the potential damage of heat, it is recommended that Personnel exposed to equipment capable of generating high SPL use hearing protection while such equipment is under operation.

The apparatus shall be connected to a mains socket outlet with a protective earthing connection.

The mains plug or an appliance coupler is used as the disconnect device, the disconnect device shall remain readily operable.

IN THIS MANUAL

1. INTRODUCTION	1
2. QUICK START - SPEAKER CABINETS	4
- For Passive Full-range Speakers	
- For Active Full-range Speakers	
- For Active Subwoofer & Satellite Speakers	
3. CONNECTIONS	11
- Passive Full-range Speakers	
4. WIRE CONNECTIONS	11
- For Passive Speaker Cabinets	
5. CONNECTIONS	12
- Active FULL-RANGE Speakers	
- Active SUBWOOFER Speakers	
6. WIRE CONNECTIONS	15
- For Active Speaker Cabinets	
7. FREQUENCY RESPONSE	16
8. THCHNICAL SPECIFICATION	19

1. INTRODUCTION

Thank you for your purchasing one of our AS speaker enclosures. It is just one of the many INVOTONE products that a talented, multinational Team of Audio Engineers and Musicians have developed with their great passion for music. Your AS SERIES speaker cabinet is capable of very high sound pressure level and it has been created to give you a performance that is better than any loudspeaker in this range. They are flexible in their configurations and can be used with single and multiple subwoofers.

Enjoy your AS speaker and make sure to read this Manual carefully before operation!

2. QUICK START - PASSIVE SPEAKER CABINET

Passive, Full-range, two speakers. This is the simplest set-up. You just need a mixer and a stereo amplifier. It is good for small club gigs, disco, etc.

Make all initial connections with all the equipments powered off, and ensure that all the main volume controls are turned down completely.

- 1). Connect one side of the speaker cable to the Output CHA/CHB or Binding Post of your stereo power amplifier and the other side to the Input socket of your AS speaker cabinet.
- 2). Complete other connections as illustrated.
- 3). Turn on your mixer first, then the stereo power amplifier.
- 4). Turn up the volume controls of your amplifier to about 70%.
- 5). Use PFL function to get the proper input level for the mixer, and adjust the Main Mix Level control to manipulate the output level.
- 6). After use, turn off your stereo power amplifier first, then the mixer.

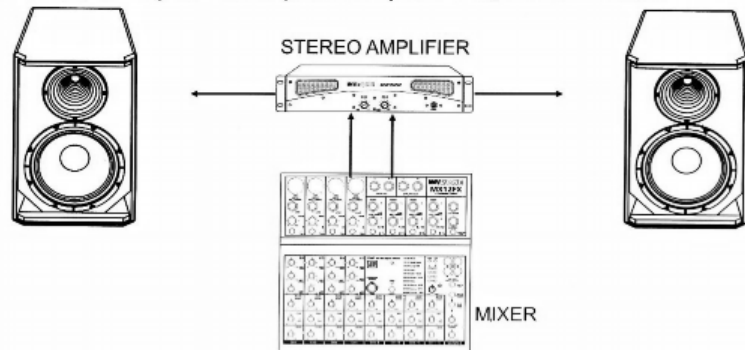

If you use a powered mixer for the passive speakers, it is no need to use an amplifier. make sure all the main volume controls of your power mixer are turned down completely.

- 1). Connect one side of the speaker cable to the SPEAKER OUT of your powered mixer and the other side to the Input socket of your AS speaker cabinet.
- 2). Use PFL function to get the proper input level for the mixer, and adjust the Main Mix Level control to manipulate the output level.
- 3). After use, turn down of the Main Mix Level control first, then turn off the powered mixer.

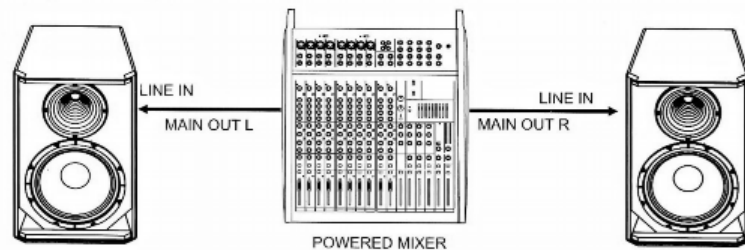

2. QUICK START - PASSIVE SPEAKER CABINETS

Passive, Full-range, four speakers. It is similar to the first set-up but four speakers are connected instead of two.

- 1). Follow the same steps as described above.
- 2). Connect the THROUGH socket of the first AS cabinet to the INPUT socket of the second AS cabinet.

NOTE: Every time you connect AS cabinets this way you parallel them to the output of the amplifier that will read half of the impedance of one speaker.

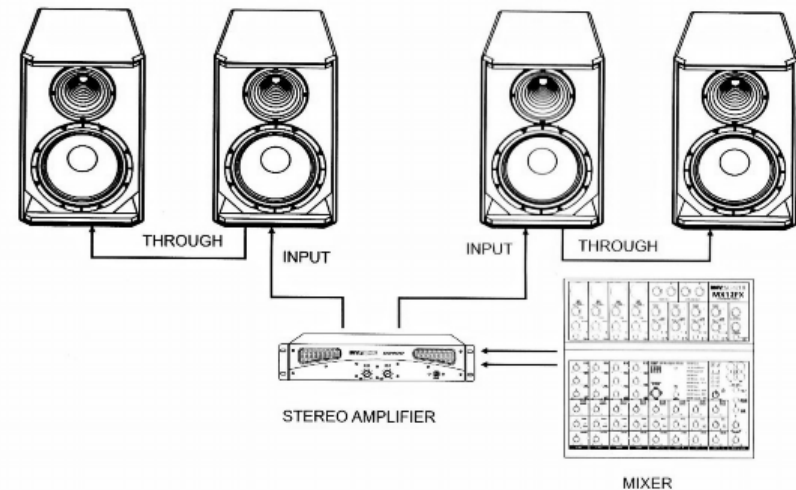

2. QUICK START - PASSIVE SPEAKER CABINETS

Passive two subwoofers and two satellite speakers. With this example, the stereo amplifier drives both the subwoofers and the satellites. In this case we do not call them full-range anymore because they receive a signal from the subwoofer that is already covered at 125 Hz. In this way, the high energetic content of the low frequencies is limited to the subwoofer and the satellite's woofer act like a mid-woofer.

- 1). Connect one side of speaker cable to the Output CHA/CHB or Binding Post of your stereo power amplifier and the other side to the Input socket of your subwoofer, with the second speaker cable connect the Output of the subwoofer to the Input of satellite.
- 2). Complete other connections as illustrated.
- 3). Turn on your mixer first, then the stereo power amplifier.
- 4). Turn up the volume controls of your amplifier to about 70%.
- 5). Use PFL function to get the proper input level for the mixer, and adjust the Main Mix Level control to manipulate the output level.
- 6). After use, turn off your stereo power amplifier first, then the mixer.

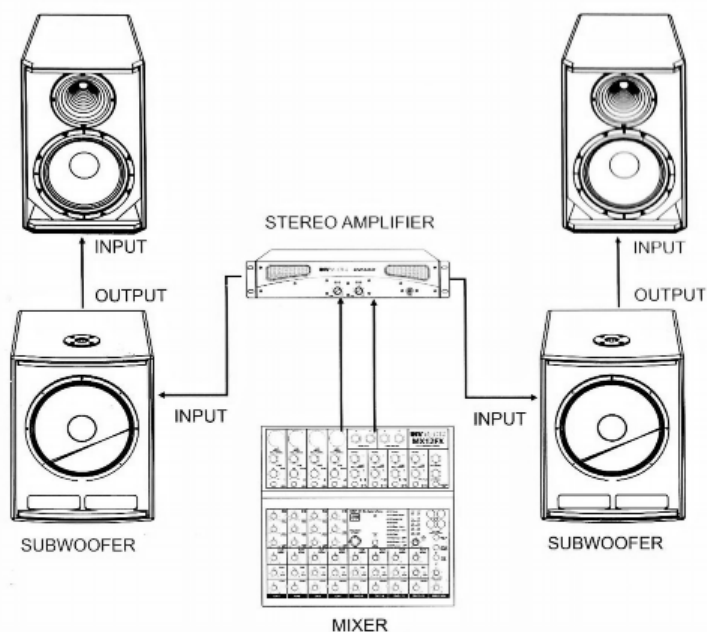

2. QUICK START - ACTIVE SPEAKER CABINETS

Active, Full-range, two speakers. It is similar to the passive example but you do not need a power amplifier in between the mixer and the two AS speakers. Make all initial connections with all the equipments powered off, and ensure that all the main volume controls are turned down completely.

- 1). Connect one side of the signal cable at your mixer into the Main Output Left/ Right (with 1/4" Jack or XLR) and the other side of the cable in to the Line Input (COMBO) of your AS active speaker cabinet (with 1/4" Jack or XLR).
- 2). Connect the power cord to mains.
- 3). Turn ON your mixer first, then the AS cabinets.
- 4). Turn up the volume control of the AS cabinets.
- 5). Use PFL function to get the proper input level for the mixer, and adjust the Main Mix Level control to reach the desired output level.
- 6). After use, turn off your active speaker cabinets first, then the mixer.

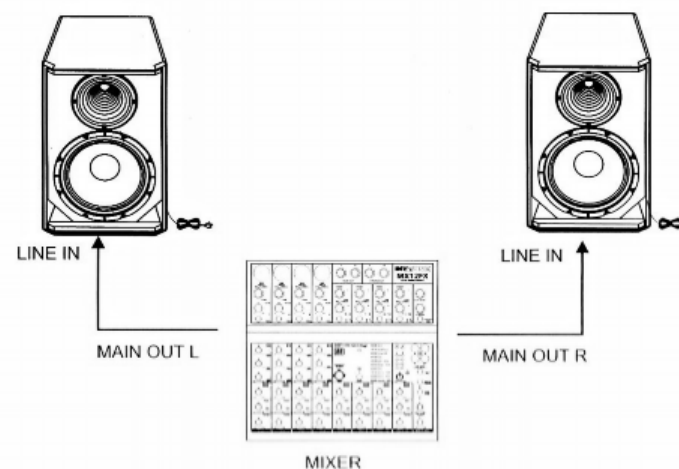

2. QUICK START - ACTIVE SPEAKER CABINETS

Active, Full-range, multiple speakers. This solution is particularly flexible when you have a large stage and for fixed installations where you want to send the same signal to different zones like in a Bar, Pub, Restaurant, Church, etc. Each AS cabinet has its own volume control so you can adjust different volumes in different zones.

- 1). Follow the above steps connecting the MAIN OUTPUTS of the mixer to the LINE INPUTS of two AS active cabinets.
- 2). Connect the LINE OUT socket of the first AS cabinet to the LINE IN socket of the subsequent piece. You can connect as many speakers as you wish in this way.

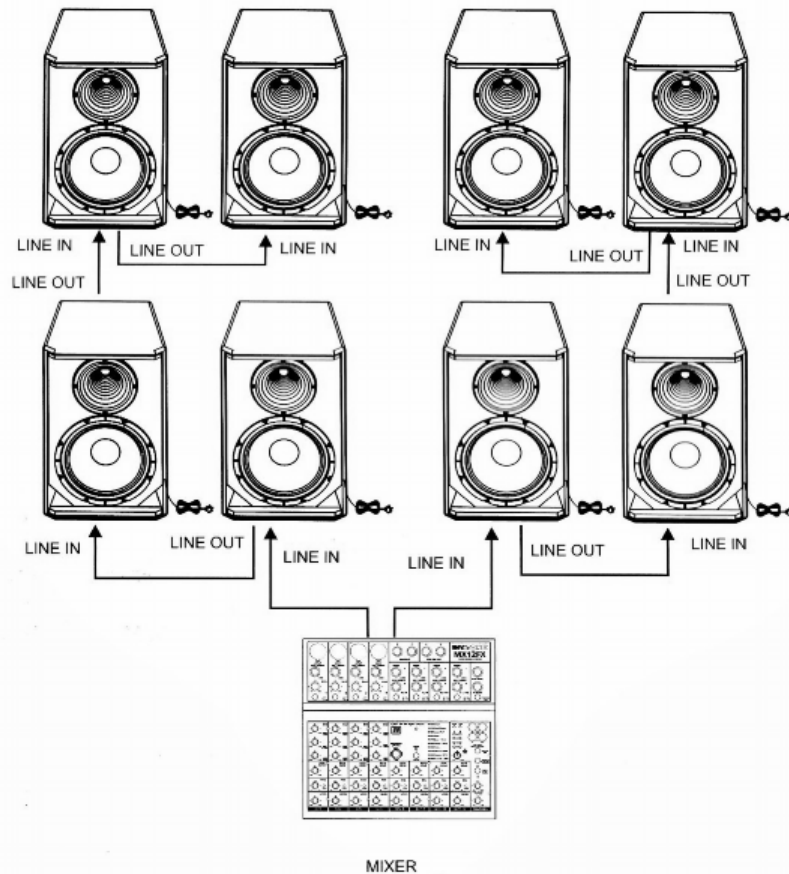

2. QUICK START - ACTIVE SPEAKER CABINETS

Active, two subwoofers & two satellite speakers. In this example, the mixer is connected to the AS subwoofers and then a 125 Hz covered line signal is sent to the respective satellites. In this way, the high energetic content of the low frequencies is limited to the subwoofer and the satellite's woofer act like a mid-woofer. As a consequence the satellites built-in amplifier is not stressed by low frequency content.

- 1). Connect one side of signal cable at your mixer into Main Output Left/Right (with 1/4" Jack or XLR) and the other side of the cable into the Left/Mono Input (COMBO) of the AS active subwoofers; with the second signal cable connect the Left/Mono Line Output of the subwoofer (Stereo/Mono-Jack or XLR) to the Line input (COMBO) of the active satellite (with Stereo - Jack or XLR).
- 2). Connect the power cord to mains.
- 3). Turn on your mixer first, then the active speaker cabinets.
- 4). Turn up the volume control of the active speaker cabinets.
- 5). Use PFL to get the proper input level for the mixer, and adjust the Main Mix Level control to manipulate the output level.
- 6). After use, turn off your active speaker cabinets first, then the mixer.

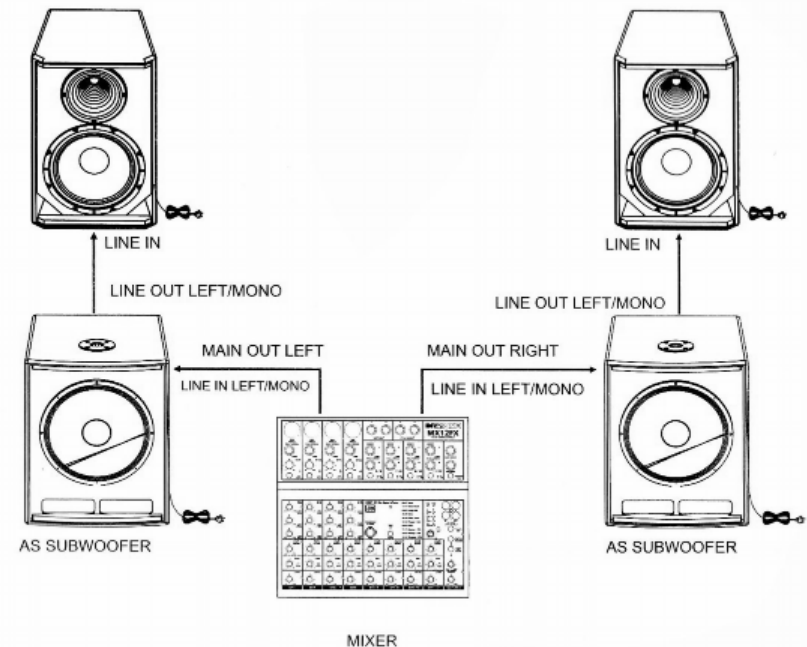

2. QUICK START - ACTIVE SPEAKER CABINETS

Active, one subwoofer and two satellite speakers.

This is a very popular combination, especially in small size clubs where there is no need for two subwoofers.

- 1). Connect one side of signal cable at your mixer into Main Output Left (with 1/4" Jack or LR) and the other side of the cable into the Left Input of the AS active subwoofer. Repeat for the RIGHT channel. With the second signal cable connect the Left Line Output of the subwoofer (Stereo/Mono-Jack or XLR) to the Line input (COMBO) of the active satellite (with Stereo-Jack or XLR). Repeat for the RIGHT channel.
- 2). Connect the power cord to mains.
- 3). Turn on your mixer first, then the active speaker cabinets.
- 4). Turn up the volume control of the active speaker cabinets.
- 5). Use PFL function to get the proper input level for the mixer, and adjust the Main Mix Level control to manipulate the output level.
- 6). After use, turn off your active speaker cabinets first, then the mixer.

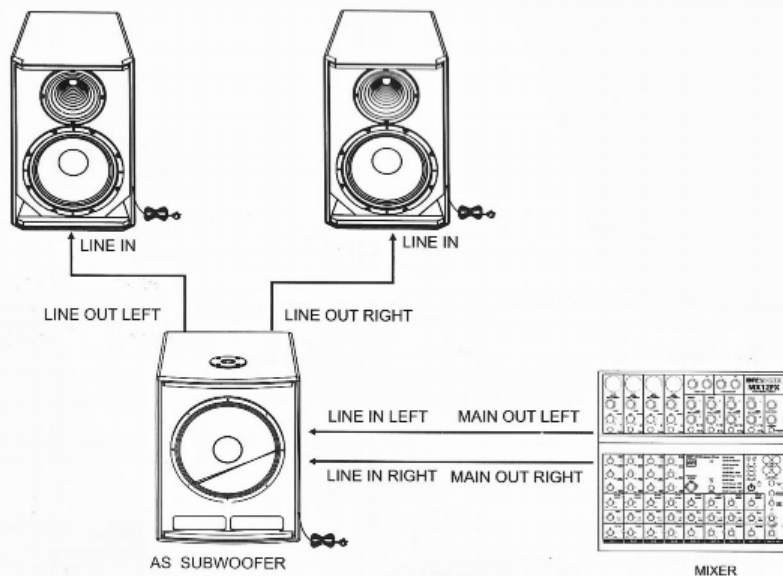

3. CONNECTIONS

- PASSIVE FULL-RANGE: AS12/AS15

- 1). INPUT: Receive the signal coming from an external power amplifier. (SPK +1/-1 connected; +2/-2 not connected).
- 2). THRU: Direct LINK to connect in parallel a second speaker cabinet (SPK +1/-1 connected; +2/-2 not connected).

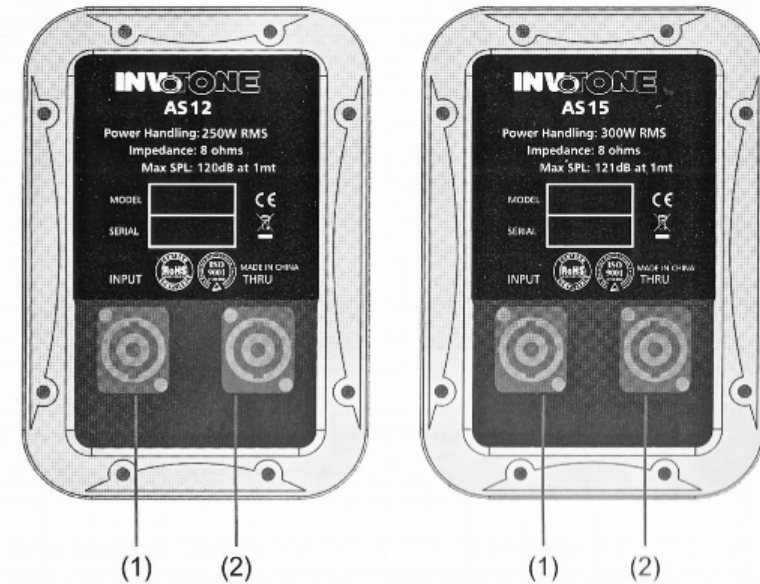

4. WIRE CONNECTIONS

- For Passive Speaker Cabinets

Please only use the power connectors to make connections with other signal source equipment for the passive speaker cabinets. The power connector has four terminals: 1+, 1-, 2+, 2-.

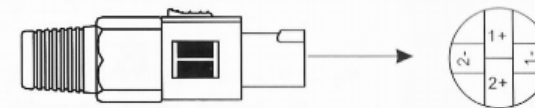

In our cabinets, only 1+/1- are used to connect the Speaker+/Speaker-, and 2+/2- are not used.

5. CONNECTIONS

ACTIVE FULL- RANGE :

AS10A

- 1). ON-OFF power switch.
- 2). Input AC power socket with main fuse.
- 3). Ground lift Switch.
- 4). POWER, blue LED, indicate ON status.
- 5). SIGN/COMP, signal/ compressor, Green/red LED
- 6). LINE OUT at + 4dB on XLR connector
- 7). LINE IN at + 4dB on COMBO connector.
- 8). VOLUME main power amplifier control.
- 9). LOW/MID/HIGH, EQ tone control at +/- 6dB.
- 10). GAIN control for microphone -10/-45dB.
- 11). MIC IN on balanced XLR, for microphone.

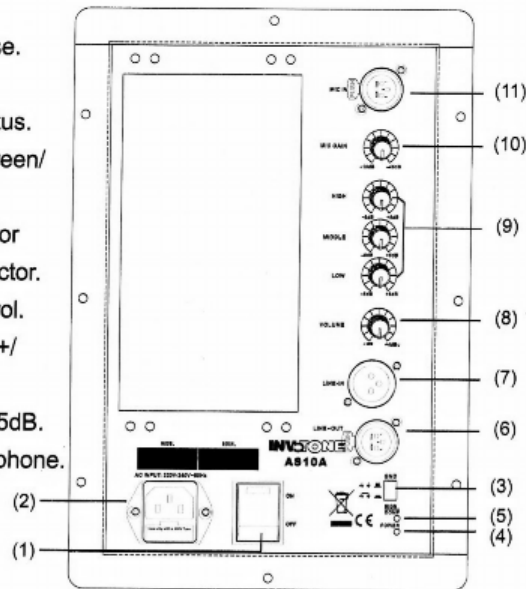

3 BANDS EQ

You have three EQ control on your AS 2-way active cabinets each providing providing +/- 6dB of boost and cut. The signal will be unaffected when the controls are on center position.

- HI

If you turn this control up you will boost all the frequencies above 12 kHz (shelving filter). You will add transparency to vocals and guitar and also make cymbals crispier. Turn the control down to cut all frequencies above 12 kHz. In such way you can reduce sibilances of human voice or reduce the hiss of a Tape player.

- MID

This is a peaking filter and it will boost/cuts frequencies with their center at 2.5 kHz. This control will affect especially upper male and lower female vocal ranges and also the harmonics of most musical instruments.

- LOW

If you turn this control up you will boost all frequencies below 80 Hz. You will give more punch to bass drums and bass guitar; and you will make the male vocalist more "macho". Turn it down and you will cut all the frequencies below 80 Hz. In this way you can avoid low-frequency vibrations and resonance thus preserving the life of your woofers.

5. CONNECTIONS

ACTIVE FULL- RANGE :

AS12A/AS12MA/AS15A

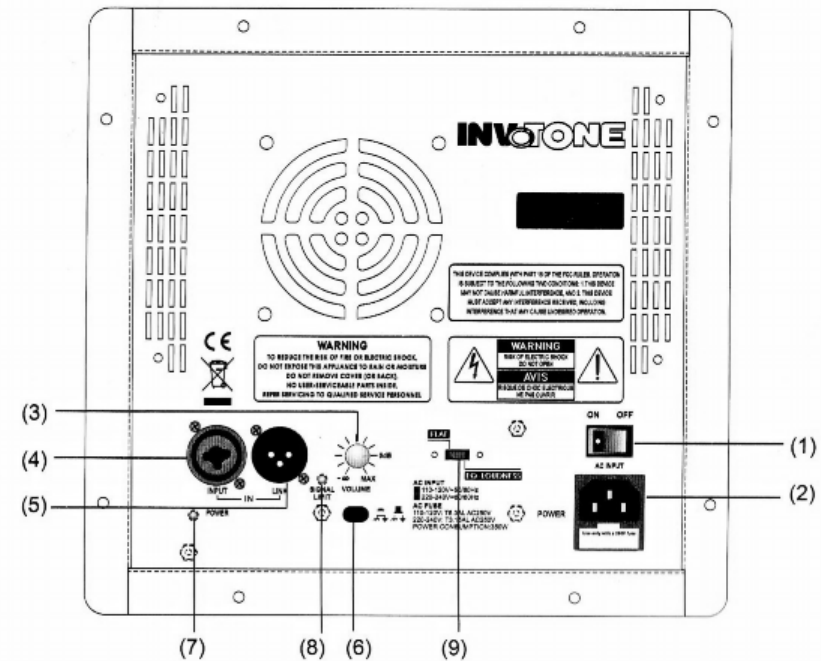

- (1) ON-OFF main power switch.
- (2) Input AC power socket with main fuse.
- (3) VOLUME main power amplifier control.
- (4) LINE OUT at + 4dB on XLR connector.
- (5) LINE IN at + 4dB on COMBO connector.
- (6) Ground Lift Switch.
- (7) POWER, Green LED, indicate ON status.
- (8) SIGNAL/LIMIT, Red LED, indicate ON status.
- (9) FLAT/LOUDNESS Switch.

5. CONNECTIONS

ACTIVE SUBWOOFERS: AS15SA

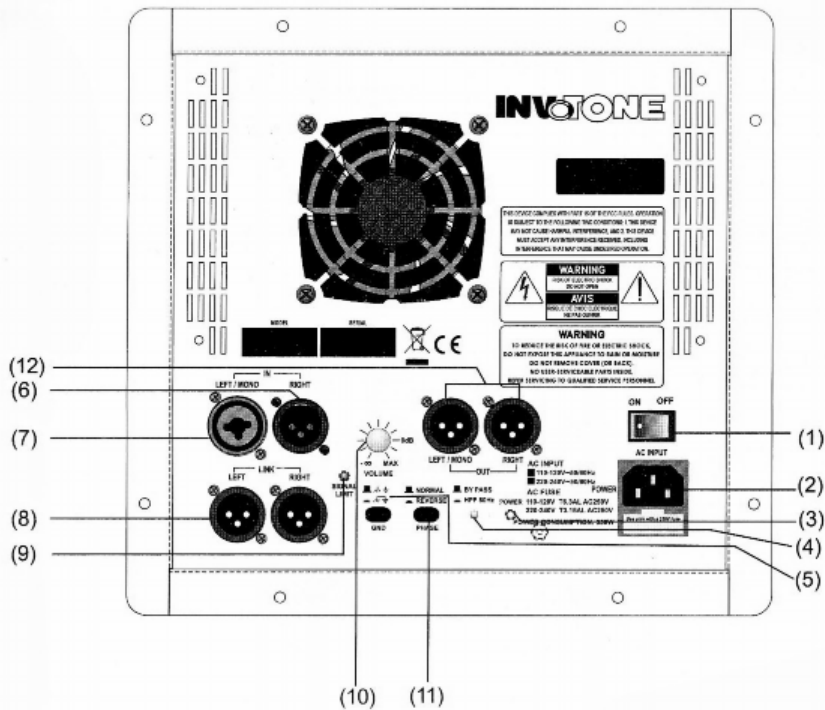

- (1) ON-OFF main power switch
- (2) Input AC power socket with main fuse
- (3) POWER, Green LED, indicate ON status
- (4) BYPASS Switch Select the High pass filter or by pass
- (5) Ground Lift Switch
- (6) LINE IN RIGHT.ON XLR CONNECTOR
- (7) LINE IN LEFT/MONO ON COMBO CONNECTOR
- (8) LINK LEFT/RIGHT ON XLR CONNECTOR
- (9) SIGNAL/LIMIT, Red LED, indicate ON status
- (10) VOLUME main power amplifier control
- (11) PHASE Switch Reverse the Polarity of the subwoofer output
- (12) OUT LEFT/RIGHT ON 2xXLR CONNECTOR

6. WIRE CONNECTIONS

- For Active Speaker Cabinets

As to these circumstances, audio connections is mostly intended for the signal flow, so, determine the wire configuration according to your real application system and its connecting facility. Normally, you have the following choices:

• Balanced

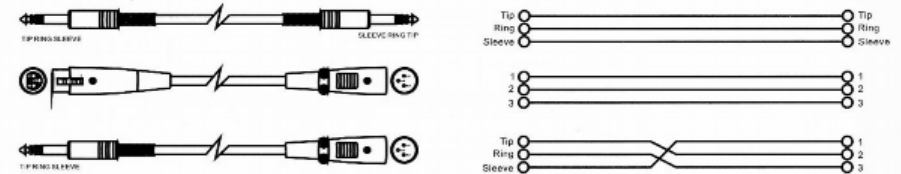

• Unbalanced

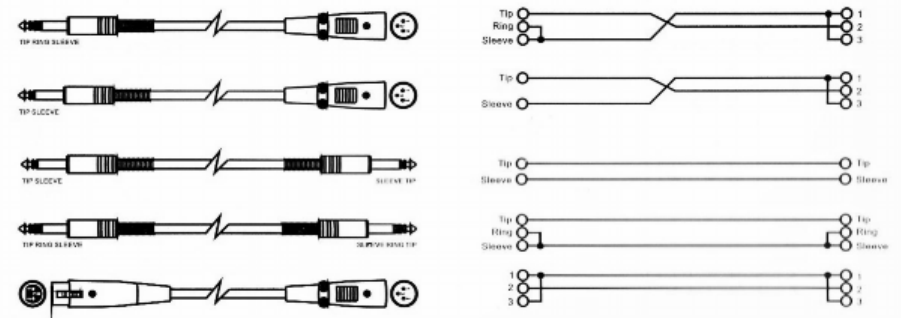

7. FREQUENCY RESPONSE

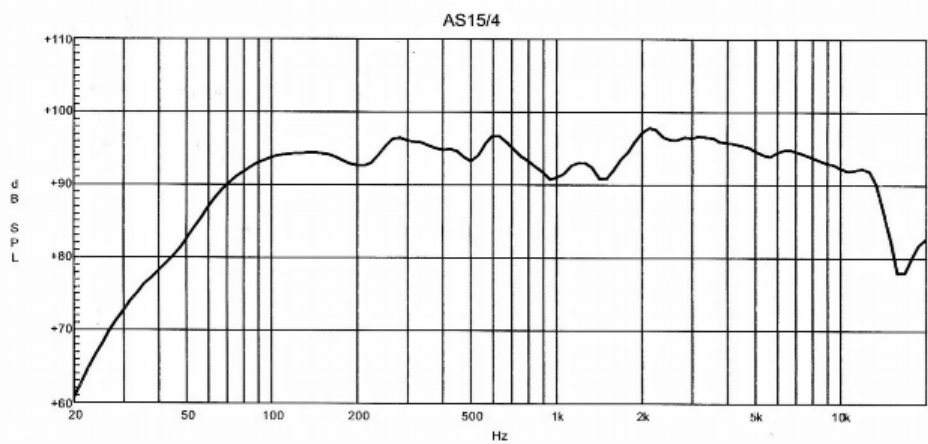
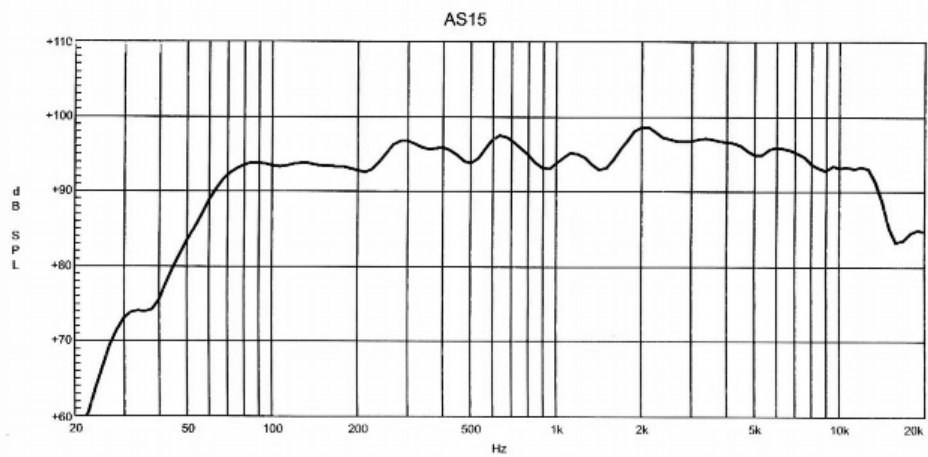
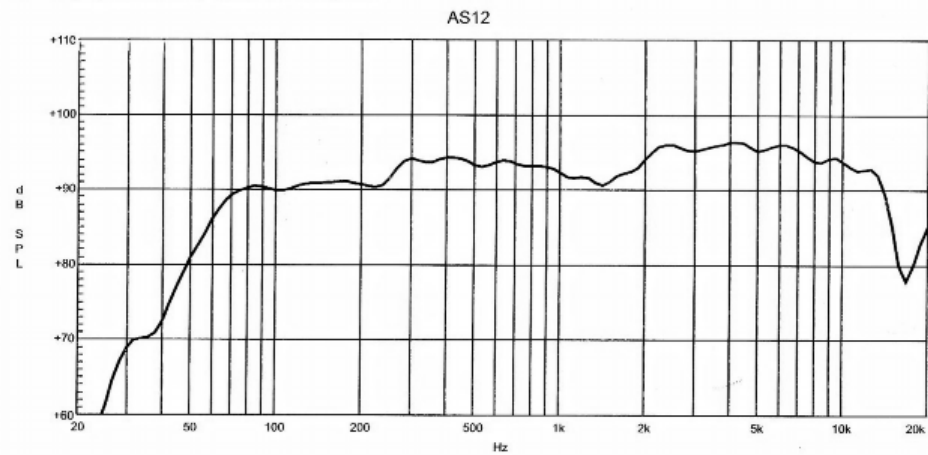

7. FREQUENCY RESPONSE

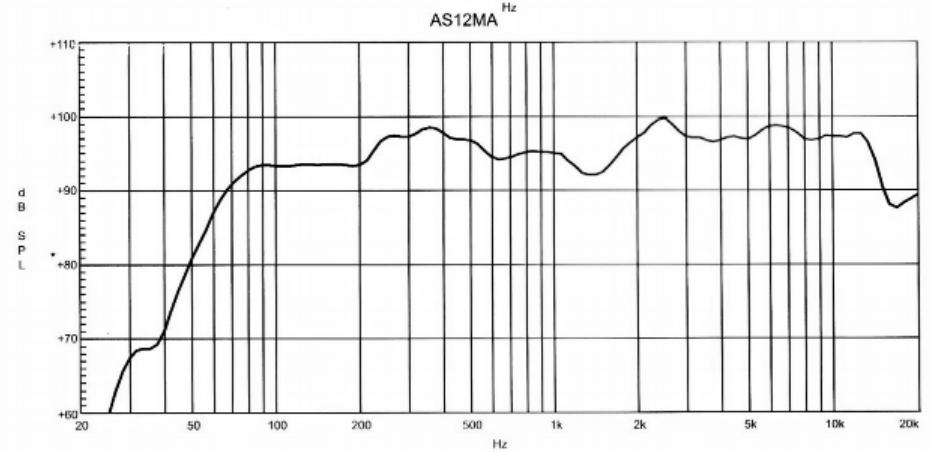
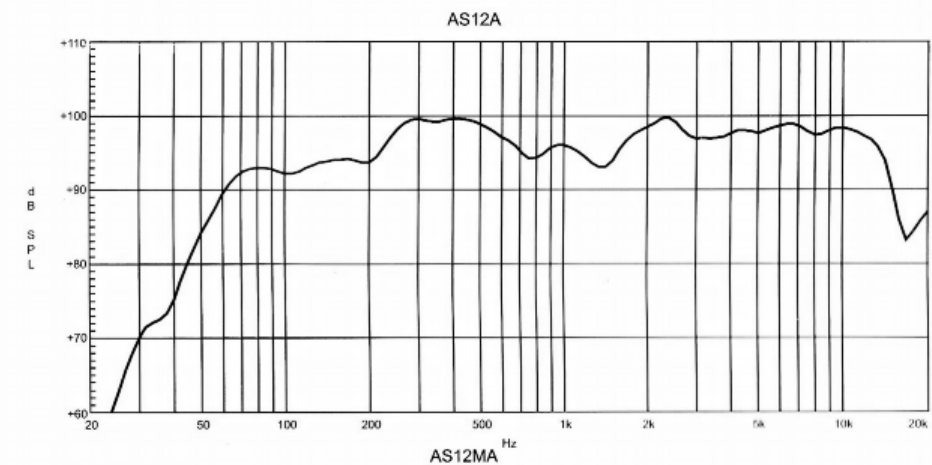
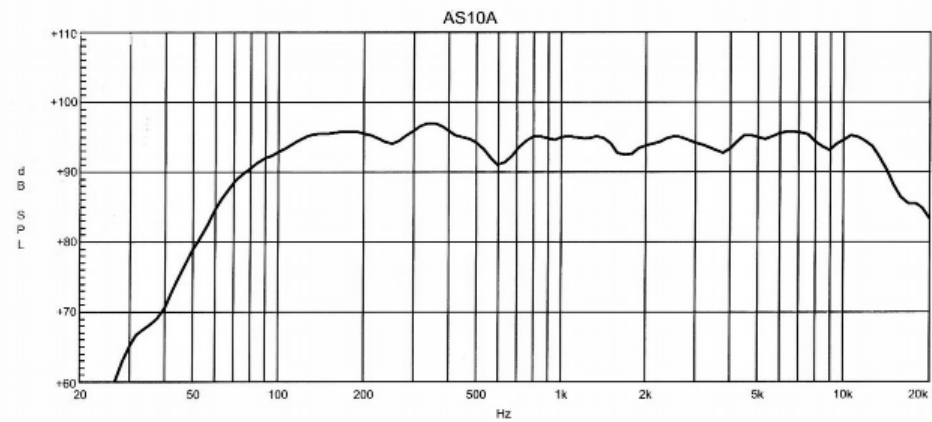

7. FREQUENCY RESPONSE

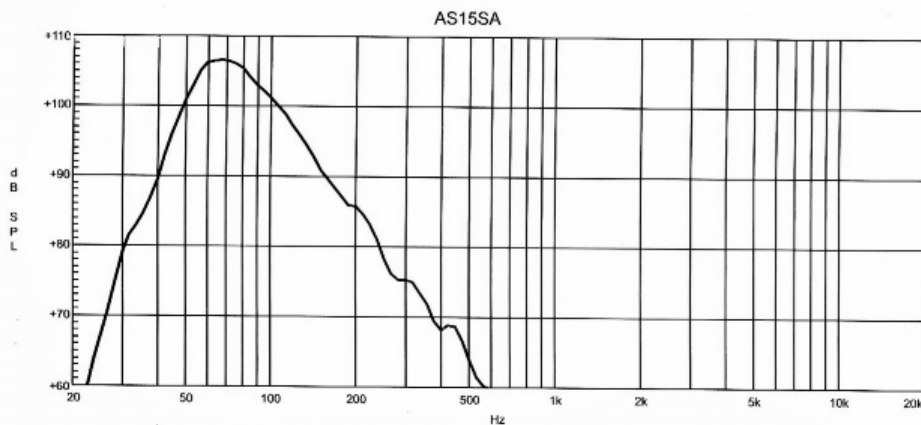
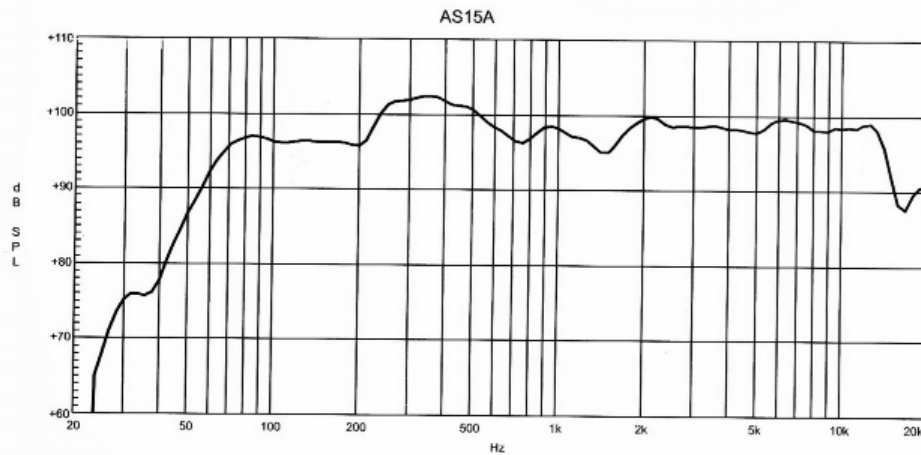

8. TECHNICAL SPECIFICATION

AS12	2 - way Passive Speaker Cabinet
Power System	250Watts RMS
Frequency Response (-10dB)	57Hz-18kHz
Sensitivity (1w @ 1mt)	94.5dB SPL
Impedance	8 Ω (nominal)
Maximum SPL @ 1m	118.5dB continuous/121.5dB peak (Calculated)
Coverage (HxV)	70° x 70° nominal
Transducer Low	12" Woofer, 2" voice coil, with double ventilation
Transducer High	1" Neodymium on Spherical Horn (Tractrix contour)
Passive Crossover	2.25kHz at 12dB/oct, with HF protection
Enclosure Construction	Chipboard cabinet, glued and reinforced, covered in black carpet; black metal corner and rubber foot.
Input Connectors	Two Parallel SPK NL-4 for INPUT/ THRU
Mounting	One standard pole-mount plus two plastic handle
Dimensions (HxWxD)	682 x 496 x 444mm (26.85" x 19.53" x 17.48")
Net Weight	16.57kg / 36.53 lbs
Shipping weight	19.82kg / 43.10 lbs

AS15	2 - way Passive Speaker Cabinet
Power System	300Watts RMS
Frequency Response (-10dB)	47Hz-18kHz
Sensitivity (1w @ 1mt)	96.5dB SPL
Impedance	8Ω or 4Ω (nominal)
Maximum SPL @ 1m	121dB continuous/124dB peak (Calculated)
Coverage (HxV)	70° x 70° nominal
Transducer Low	15" Woofer, 2.5" voice coil, with double ventilation
Transducer High	1" Neodymium on Spherical Horn (Tractrix contour)
Passive Crossover	2kHz at 12dB/oct, with HF protection
Enclosure Construction	Chipboard cabinet, glued and reinforced, covered in black carpet; black metal corner and rubber foot.
Input Connectors	Two Parallel SPK NL-4 for INPUT/ THRU
Mounting	One standard pole-mount plus two plastic handle
Dimensions (HxWxD)	749 x 552 x 478mm (29.49" x 21.73" x 18.82")
Net Weight	20.64kg / 45.50 lbs
Shipping weight	23.93kg / 52.76 lbs

8. TECHNICAL SPECIFICATION

AS10A	2-Way 10" Active Speaker Cabinets
Power System	150Watts RMS
Max SPL at 1mt	117.5 dB(IHF Power)
Input Sensitivity	Line 0 dB/0.775 V/Mic-10 at -45 dB
Input Impedance	30 kOhms Balanced -15 kOhms Unbalanced
Connectors	Mic on XLR/Line Input on Combo/Line-Mix Output on XLR
Subsonic Filter	30 Hz-24 dB/oct.
Protections	Soft-Start, Compressor
External Control	Mic Gain-EQ-High-Mid-Low-Volume-Ground Switch
Power Supply	230 Volt/115 Volt 50/60 Hz
Dimensions(HxWxD)	641 x 442 x 396mm (25.24" x 17.40" x 15.59")
Net Weight (lbs/kg)	19.38kg / 42.73 lbs
Gross Weight (lbs/kg)	22.15kg / 48.83 lbs
Volume	4.58 CFT

8. TECHNICAL SPECIFICATION

AS12A	2-Way 12" Active Speaker Cabinets
Power System	300Watts RMS
Frequency Response (-10dB)	57Hz-18kHz, FLAT/ 47Hz-20kHz, EQ.LOUDNESS
Maximum SPL @ 1m	121dB Continuous/ 124dB Peak (Calculated)
Coverage (HxV)	70' x 70' nominal
Transducer Low	12" Woofer, 2"voice coil, with double ventilation
Transducer High	1" Neodymium on Spherical Horn (Tractrix contour)
Active Crossover	2kHz under analog processor, FLAT or EQ. LOUDNESS
Input Connector	LINE-COMBO/ LINK-XLR-M Balanced (15kohm)
Input Level	Line 0dBu
External Control	Volume Control/ Flat-Eq.Loudness/ Power ON with Green LED/ Clip Limiter with Red LED/ Ground Lift
Power Supply	120-240 Volt - Switching Power Mode
Enclosure Construction	Chipboard cabinet, glued and reinforced, covered in black carpet; black metal corner and rubber foot.
Mounting	One standard pole-mount plus two plastic handle
Dimensions (HxWxD)	682 x 496 x 444mm (26.85" x 19.53" x 17.48")
Net Weight	18.63 kg / 41.07lbs
Shipping Weight	21.82 kg / 48.10lbs

AS12MA	2-Way 12" Active Monitor Speaker Cabinets
Power System	300Watts RMS
Frequency Response (-10dB)	64Hz-18kHz, FLAT/ 60Hz-20kHz,EQ.LOUDNESS
Maximum SPL @ 1m	121dB Continuous/124dB Peak (Calculated)
Coverage (HxV)	70' x 70' nominal
Transducer Low	12" Woofer, 2"voice coil,with double ventilation
Transducer High	1" Neodymium on Spherical Horn (Tractrix contour)
Active Crossover	2kHz under analog processor, FLAT or EQ. LOUDNESS
Input Connector	LINE-COMBO/ LINK-XLR-M Balanced (15kohm)
Input Level	Line 0dBu
External Control	Volume Control/ Flat-Eq.Loudness/ Power ON with Green LED/ Clip Limiter with Red LED/ Ground Lift.
Power Supply	120-240 Volt - Switching Power Mode
Enclosure Construction	Chipboard cabinet, glued and reinforced, covered in black carpet; black metal corner and rubber foot.
Mounting	One standard pole-mount plus one plastic handle
Dimensions (HxWxD)	671 x 494 x 481 mm (26.42" x 19.45" x 18.94")
Net Weight	18.02kg / 39.73 lbs
Shipping Weight	21.42kg / 47.22 lbs

8. TECHNICAL SPECIFICATION

AS15A	2-Way 15" Active Speaker Cabinets
Power System	350Watts RMS
Frequency Response (-10dB)	54Hz-18kHz, FLAT/ 47Hz-20kHz, EQ. LOUDNESS
Maximum SPL @ 1m	122dB Continuous/125dB Peak (Calculated)
Coverage (HxV)	70 x 70 nominal
Transducer Low	15" Woofer, 2.5" voice coil, with double ventilation
Transducer High	1" Neodymium on Spherical Horn (Tractrix contour)
Active Crossover	2kHz under analog processor, FLAT or EQ. LOUDNESS
Input Connector	LINE-COMBO/ LINK-XLR-M Balanced (15kohm)
Input Level	Line 0dBu
External Control	Volume Control/ Flat-Eq.Loudness/ Power ON with Green LED/ Clip Limiter with Red LED/ Ground Lift.
Power Supply	120-240 Volt - Switching Power Mode
Enclosure Construction	Chipboard cabinet, glued and reinforced, covered in black carpet; black metal corner and rubber foot
Mounting	One standard pole-mount plus two plastic handle
Dimensions (HxWxD)	749 x 552 x 478 mm (29.49" x 21.73"x 18.82")
Net Weight	23.06kg / 50.84 lbs
Shipping Weight	26.72kg / 58.91 lbs

AS15SA	15" Active Subwoofer Speaker Cabinets
Power System	350Watts RMS
Frequency Response (-10dB)	42Hz-125Hz
Maximum SPL @ 1m	121dB Continuous/124dB Peak (Calculated)
Transducer Low	15" Woofer, 2.5"voice coil, with double ventilation
Active Crossover	HPF 80Hz under analog processor
Input Connector	L-R Input (Combo/ XLR-F) / L-R Link (2-XLR-M) / L-R Output (2-XLR-M) Balanced (15kohm)
Input Level	L-R Input Line 0dBu
External Control	Volume Control/ Phase Switch / HPF-80Hz By-Pass/ Power ON with Green LED/ Clip Limiter with Red LED/ Ground Lift.
Power Supply	120-240 Volt, in Switching Power mode.
Enclosure Construction	Chipboard cabinet, glued and reinforced, covered in black carpet; black metal corner and rubber foot
Mounting	One metal standard pole-mount plus two plastic handle
Dimensions (HxWxD)	638 x 602 x 542 mm (25.12" x 23.70" x 21.34")
Net Weight	26.78kg / 59.04 lbs
Shipping Weight	31.25kg / 68.89 lbs