

KORG

Pa 9000
professional arranger

User Manual

Important safety instructions

- Read these instructions.
- Keep these instructions.
- Heed all warnings.
- Follow all instructions.
- Do not use this apparatus near water.
- Clean only with dry cloth.
- Do not block any ventilation openings, install in accordance with the manufacturer's instructions.
- Do not install near any heat sources such as radiators, heat registers, stoves, or other apparatus (including amplifiers) that produce heat.
- Protect the power cord from being walked on or pinched particularly at plugs, convenience receptacles, and the point where they exit from the apparatus.
- Only use attachments/accessories specified by the manufacturer.
- Unplug this apparatus during lightning storms or when unused for long periods of time.
- Refer all servicing to qualified service personnel. Servicing is required when the apparatus has been damaged in any way, such as power-supply cord or plug is damaged, liquid has been spilled or objects have fallen into the apparatus, the apparatus has been exposed to rain or moisture, does not operate normally, or has been dropped.
- Turning off the standby switch does not completely isolate this product from the power line so remove the plug from the socket if not using it for extended periods of time, or before cleaning. Please ensure that the mains plug or appliance couple remains readily accessible.
- Mains powered apparatus shall not be exposed to dripping or splashing and that no objects filled with liquids, such as vases, shall be placed on the apparatus.
- Install this product near the wall socket and keep the power plug easily accessible.
- Do not install this equipment on the far position from wall outlet and/or convenience receptacle.
- **WARNING** – Date/time Lithium button cell battery inside. Danger of explosion if battery is incorrectly replaced. Replace only with the same or equivalent type. The internal date/time Lithium button cell battery is user replaceable.
- Do not expose batteries to excessive heat, such as direct sunshine, fire or the like.
- Dispose of used batteries according to the battery manufacturer's instructions.
- Do not install this equipment in a confined space such as a box for the conveyance or similar unit.
- When a cart is used, use caution when moving the cart/apparatus combination to avoid injury from tip-over.



WARNING:
TO REDUCE THE RISK OF FIRE OR ELECTRIC SHOCK DO NOT
EXPOSE THIS PRODUCT TO RAIN OR MOISTURE.



The lightning flash with arrowhead symbol within an equilateral triangle, is intended to alert the user to the presence of uninsulated “dangerous voltage” within the product's enclosure that may be of sufficient magnitude to constitute a risk of electric shock to persons.



The exclamation point within an equilateral triangle is intended to alert the user to the presence of important operating and maintenance (servicing) instructions in the literature accompanying the product.

THE FCC REGULATION WARNING (USA)

This equipment has been tested and found to comply with the limits for a Class B digital device, pursuant to Part 15 of the FCC Rules. These limits are designed to provide reasonable protection against harmful interference in a residential installation. This equipment generates, uses, and can radiate radio frequency energy and, if not installed and used in accordance with the instructions, may cause harmful interference to radio communications. However, there is no guarantee that interference will not occur in a particular installation. If this equipment does cause harmful interference to radio or television reception, which can be determined by turning the equipment off and on, the user is encouraged to try to correct the interference by one or more of the following measures:

- Reorient or relocate the receiving antenna.
- Increase the separation between the equipment and receiver.
- Connect the equipment into an outlet on a circuit different from that to which the receiver is connected.
- Consult the dealer or an experienced radio/TV technician for help.

Unauthorized changes or modification to this system can void the user's authority to operate this equipment.

CE MARK FOR EUROPEAN HARMONIZED STANDARDS

CE mark which is attached to our company's products of AC mains operated apparatus until December 31, 1996 means it conforms to EMC Directive (89/336/EEC) and CE mark Directive (93/68/EEC).

And, CE mark which is attached after January 1, 1997 means it conforms to EMC Directive (89/336/EEC), CE mark Directive (93/68/EEC) and Low Voltage Directive (73/23/EEC).

Also, CE mark which is attached to our company's products of Battery operated apparatus means it conforms to EMC Directive (89/336/EEC) and CE mark Directive (93/68/EEC).

IMPORTANT NOTICE TO CONSUMERS

This product has been manufactured according to strict specifications and voltage requirements that are applicable in the country in which it is intended that this product should be used. If you have purchased this product via the internet, through mail order, and/or via a telephone sale, you must verify that this product is intended to be used in the country in which you reside.

WARNING: Use of this product in any country other than that for which it is intended could be dangerous and could invalidate the manufacturer's or distributor's warranty.

Please also retain your receipt as proof of purchase otherwise your product may be disqualified from the manufacturer's or distributor's warranty.

NOTICE REGARDING DISPOSAL (EU)



If this symbol is shown on the product, manual, battery, or package, you must dispose of it in the correct manner to avoid harm to human health or damage to the environment. Contact your local administrative body for details on the correct disposal method. If the battery contains heavy metals in excess of the regulated amount, a chemical symbol is displayed below the symbol on the battery or battery package.



PERCHLORATE (CALIFORNIA, USA)

Perchlorate Material – special handling may apply.
See www.dtsc.ca.gov/hazardouswaste/perchlorate.

Automatic Power-Off

To avoid wasting power, Pa900 will by default automatically turns to standby after two hours of non-active use (playing, pressing buttons or using the touch-screen). Please save your data (Performances, Styles, Songs, and so on) before taking a prolonged pause.

Data Handling

Data in memory may sometimes be lost due to incorrect user action. Be sure to save important data to the internal hard disk or to an external USB device. Korg will not be responsible for damages caused by data loss.

Cleaning

If the exterior becomes dirty, wipe it with a clean, dry cloth. Do not use liquid cleaners such as benzene or thinner, or cleaning compounds or flammable polishes.

Use a soft cotton cloth to clean the display. Some materials, such as paper towels, could cause scratches and damage it. Computer wipes are also suggested, provided they are specifically designed for LCD screens.

Do not spray any liquids on the LCD screen directly. Always apply the solution to your cloth first, then clean the screen.

Example screens

Some pages of the manuals show LCD screens along with an explanation of functions and operations. All sound names, parameter names, and values are merely examples and may not always match the actual display you are working on.

Disclaimer

The information contained in this manual have been carefully revised and checked through. Due to our constant efforts to improve our products, the specifications might differ to those in the manual. Korg is not responsible for any difference found between the specifications and the contents of the instruction manual – the specifications being subject to change without prior notice.

Trademarks

Mac is a registered trademark of Apple, Inc. MS-DOS and Windows are registered trademarks of Microsoft Corporation. TC-Helicon is a registered trademark of TC-Helicon Vocal Technologies Ltd. All other trademarks or registered trademarks are the property of their respective holders.

Open Source notice

Portions of this product's software are copyright ©2007 "The FreeType Project" (www.freetype.org). All rights reserved.

Liability

Korg products are manufactured under strict specifications and voltages required by each country. These products are warranted by the Korg distributor only in each country. Any Korg product not sold with a warranty card or carrying a serial number disqualifies the product sold from the manufacturer's/distributor's warranty and liability. This requirement is for your own protection and safety.

Service and User's Assistance

For service, please contact your nearest Authorized Korg Service Center. For more information on Korg products, and to find software and accessories for your keyboard, please contact your local Authorized Korg distributor. For up-to-date information, please point your web browser to www.korg.com.

Table of Contents

Introduction

Welcome!	6
What's in the box	7
About this manual	7
Contacts	7
Making a safety copy of your data	7
Restoring the original factory data	7
Loading the Operating System	7
Overview	8
FFront Panel	8
Rear Panel	19
Start up	21
Connecting the AC power cord	21
Turning the instrument on (or in standby)	21
Controlling the Volume	21
The X-Fader slider	21
Headphones	21
Loudspeakers	22
Audio Outputs	22
MIDI connections	22
Damper pedal	22
Assignable pedal	22
The music stand	22
Glossary of Terms	23
Sound	23
Style	23
Pad	23
Keyboard tracks	23
Performance	24
Sequencer	24
Player	24
The LOGO decoder	24
Interface basics	25
Color TouchView graphical user interface	25
Operative modes	27
Selected, highlighted items	27
Non-available, grayed-out parameters	27
Shortcuts	27
Easy Mode	28
The Style Play page in detail	29
The Song Play page in detail	30
Quick Guide	
Turning the instrument on	32
Turning the instrument on and viewing the main screen	32
Connecting and calibrating the Damper pedal	33
Programming the Damper pedal	33
Playing the Demo	35
Starting and stopping the Demo	35
Playing Sounds	37
Selecting a Sound and playing it on the keyboard	37
Playing two or three Sounds at the same time	39
Playing different Sounds with your left and right hand	41
Changing the split point	43
Raising or lowering the Upper octave	44
Selecting and saving Performances	45
Selecting a Performance	45
Saving your settings to a Performance	46
Selecting and saving the "My Setting" Performance ...	48
Selecting the startup parameters (the "My Setting" Performance)	48
Saving the startup parameters into the "My Setting" Performance	48
Drawbars	49
Choosing a Drawbars Preset	49
Editing the Drawbars Preset	50
Selecting and playing Styles	52
Selecting and playing a Style	52
Tempo	54
Intro, Variation, Fill, Break, Ending	55
Single Touch Settings (STS)	56
The Pads	57
Adjusting the balance between the Style and the keyboard ..	58
Adjusting the volume of the separate tracks	58
Turning the Style tracks on/off	59
Adding harmony notes to your right-hand melody with the ENSEMBLE function	60
The Chord Sequencer	62
Song Play	64
Selecting a Song to play	64
Playing back a Song	66
Changing the tracks' volume	67
Turning the Song tracks on/off	69
Soloing a track	70
Removing the Melody track from a Standard MIDI File or the Lead Vocal from an MP3 file	70
Mixing two Songs	72
The SongBook	73
Selecting the desired Entry from the Main List	73
Displaying Artist or Genre	74
Sorting Entries	75
Searching for Entries	75
Adding Entries	77
Editing the Entries	77
Creating a Custom List	79
Selecting and using a Custom List	81
Synchronizing the SongBook with external software	81
Singing with a microphone	82
Connecting a microphone	82
Setting up your voice tone	83
Choosing a Voice Processor Preset	85
Applying harmony to your voice while playing with the Styles	86
Applying harmony to your voice while playing with a Song ..	86
Balancing the voice, effects and tracks level	87
Soloing your voice (Talk)	87
Recording a new Song (Standard MIDI File)	88
Preparing the Style and Sounds	88
Accessing the Backing Sequence (Quick Record) mode	88
Setting the Record parameters	90

Recording	90
Second-take recording (Overdubbing)	92
Saving a Song	92
Recording a new Song (MP3 file)	94
Searching files and musical resources	96
How to use the Search function	96
Notes about searching	98

Reference

Selecting elements	100
Style Select window	100
Sound Select window	101
Performance Select window	102
Pad Select window	102
STS Select	103
Song Select window	103
Style Play mode	106
Start-up settings	106
How Styles, Variations, Performances and STSs are linked together	106
Styles and Pads	106
Master Volume and Balance	106
Factory, Favorite and User Styles	106
Main page	107
STS Name panel	109
Volume panel	109
Pad panel	111
Split panel	112
Sub-Scale panel	112
Mic panel	113
Edit menu	113
Edit page structure	113
Mixer/Tuning: Volume/Pan	114
Mixer/Tuning: FX Send	115
Mixer/Tuning: EQ Gain	115
Mixer/Tuning: EQ Control	116
Mixer/Tuning: Tuning	116
Mixer/Tuning: Sub Scale	117
Effects: A/B FX Configuration	119
Effects: Master 1, 2	119
Track Controls: Mode	120
Track Controls: Drum Edit	121
Track Controls: Easy Edit	122
Keyboard/Ensemble: Key/Velocity Range	123
Keyboard/Ensemble: Ensemble	123
Keyboard/Ensemble: Keyboard Control	124
Pad/Switch: Pad	125
Pad/Switch: Switch	125
Style Controls: Drum/Fill	126
Style Controls: Keyboard Range On/Off / Wrap Around	126
Page menu	127
Write Performance dialog box	128
Write Single Touch Setting dialog box	128
Write Current Style Settings dialog box	129
The Favorite banks	129
Style/Pad Record mode	130
Recording Styles and Pads	130
Style/Pad Import/Export	132
Entering the Style/Pad Record mode	132
Exit by saving or deleting changes	132
Listening to the Style while in Edit mode	132

List of recorded events	133
Main page - Record 1	133
Main page - Record 2/Cue	137
Main page - Guitar Mode	138
Style/Pad Record procedure	142
Edit menu	144
Edit page structure	144
Event Edit: Event Edit	145
Event Edit: Filter	147
Style/Pad Edit: Quantize	148
Style/Pad Edit: Transpose	148
Style/Pad Edit: Velocity	149
Style/Pad Edit: Cut	150
Style/Pad Edit: Delete	150
Style/Pad Edit: Delete All	151
Style/Pad Edit: Copy from Style	151
Style/Pad Edit: Copy from Pad	152
Style Element Track Controls: Sound/Expression	153
Style Element Track Controls: Keyboard Range	154
Style Element Track Controls: Noise/Guitar	154
Pad Track Controls: Sound/Expression	155
Style Element/Pad Chord Table: Chord Table	156
Style Track Controls: Type/Trigger/Tension	156
Import: Import Groove	157
Import: Import SMF	157
Export SMF	160
Page menu	161
Write Style/Pad dialog box	162
Copy Key/Chord dialog box	162
Copy Sounds dialog box	162
Copy Expression dialog box	163
Copy Key Range dialog box	163
Copy Chord Table dialog box	163
Overdub Step Recording window	164
Song Play mode	165
Transport controls	165
MIDI Clock	165
Tempo Lock	165
Master Volume, Balance, X-Fader	165
Track parameters	165
Standard MIDI Files and Sounds	166
Keyboard, Pad and Player tracks	166
Main page (Normal view)	167
STS Name panel	169
Volume panel	169
Pad panel	170
Split panel	170
Sub-Scale panel	170
Jukebox panel	170
Mic panel	171
Edit menu	171
Edit page structure	171
Mixer/Tuning: Volume/Pan	172
Mixer/Tuning: FX Send	172
Mixer/Tuning: EQ Gain	172
Mixer/Tuning: EQ Control	173
Mixer/Tuning: Tuning	173
Effects: A/B FX Configuration	173
Effects: Master 1, 2	174
Track Controls: Mode	174
Track Controls: Drum Edit	174
Track Controls: Easy Edit	174
Keyboard/Ensemble: Key/Velocity Range	174

Keyboard/Ensemble: Ensemble	174
Keyboard/Ensemble: Keyboard Control	174
Pad/Switch: Pad	174
Pad/Switch: Assignable Switch	175
Jukebox Editor	175
Page menu	176
Sequencer mode	177
Transport controls	177
Standard MIDI Files and MP3	177
Songs and Voice Processor Presets	177
Sequencer Play - Main page	177
Entering Record mode	179
Record mode: Multitrack Sequencer page	180
Record mode: Step Record page	182
Record mode: Backing Sequence (Quick Record) page	184
Record mode: Step Backing Sequence page	187
Edit menu	189
Edit page structure	189
Mixer/Tuning: Volume/Pan	190
Mixer/Tuning: FX Send	190
Mixer/Tuning: EQ Gain	190
Mixer/Tuning: EQ Control	190
Mixer/Tuning: Tuning	191
Mixer/Tuning: Sub Scale	191
Effects: A/B FX Configuration	191
Effects: Master 1, 2	192
Track Controls: Mode	192
Track Controls: Drum Edit	192
Track Controls: Easy Edit	192
Event Edit: Event Edit	192
Event Edit: Filter	194
Song Edit: Quantize	194
Song Edit: Transpose	195
Song Edit: Velocity	195
Song Edit: Cut/Insert Measures	196
Song Edit: Delete	196
Song Edit: Copy	197
Song Edit: Move	197
Song Edit: RX Convert	197
Page menu	198
Song Select window	199
Save Song window	199
Sound mode	201
The MIDI channel	201
How to select oscillators	201
Sounds, Drum Kits, Digital Drawbars	201
Main page	201
Digital Drawbars page	203
Edit menu	204
Edit page structure	204
Basic: Sound Basic	204
Basic: OSC Basic	206
Basic: Vel/Key Zone	208
Basic: Damper Mode	208
Basic: Damper Trigger	209
Basic: EQ	210
DrumKit: Sample Setup (Drum Kits)	210
DrumKit: EQ (Drum Kits)	212
DrumKit: Voice Mixer (Drum Kits)	212
Pitch: Pitch Mod	213
Pitch: Pitch EG	215
Filter: Filter Type	217
Filter: Filter Mod	218
Filter: Filter LFO	219
Filter: Filter EG	220
Amp: Amp Level/Pan	222
Amp: Amp Mod	222
Amp: Amp EG	223
LFO: LFO1	225
LFO: LFO2	226
Effects: "B" FX Config	226
Effects: Master 1 / Reverb	227
Effects: Master 2 / Chorus	227
Page menu	227
Write Sound dialog box	228
Copy Oscillator dialog box	228
Copy Drum Kit dialog box	228
AMS (Alternate Modulation Source) list	229
Sampling mode	231
Entering and exiting the Sampling mode	231
Creating new Sounds from the Samples	231
Creating new Drum Kits from the Samples	232
Creating new Sounds from an Audio Groove	232
Edit menu	233
Sampling: Edit	233
Sampling: Loop Edit	234
Sampling: Sampling Info	235
Time Slice	236
The Time Slice procedure	239
The Extend procedure	240
Multisample: Edit MS	240
Multisample: Key Assign	241
Page menu	241
Write Sample dialog box	243
Write MultiSample dialog box	243
Write Slice dialog box	244
Delete Sample dialog box	244
Delete Multisample dialog box	244
Export Sample page	245
Export Multisample page	245
Merging Samples from various sources	245
Global mode	246
Overview on the Global mode	246
Main page	246
Edit menu	246
Edit page structure	246
General Controls: Basic	247
General Controls: Interface	248
General Controls: Lock	249
General Controls: Clock & Power	251
Mode Preferences: Style	252
Mode Preferences: Song & Sequencer	253
Mode Preferences: Media	254
Controllers: Hand Controllers	255
Controllers: Foot Controllers	255
Tuning: Basic	256
Tuning: Transpose Control	256
Tuning: Scale	257
MIDI: General Controls	258
MIDI: MIDI In Controls	259
MIDI: MIDI In Channels	260
MIDI: MIDI Out Channels	261
MIDI: Filters	261
Audio & Video: MP3 / Speakers	262
Audio & Video: Limiter	262
Audio & Video: Master EQ	263

Audio & Video: Video Out	264
Audio & Video: Audio In	264
Mic: Preset	265
Mic: Harmony	265
Mic: Harmony Voices	267
Mic: Effects	268
Mic: Global Setup	269
Mic: Global Dynamics / EQ	269
Harmony and Tuning with the Voice Processor	270
Touch Panel Calibration	274
Page menu	274
Write Quarter Tone SC Preset dialog box	275
Write Midi Preset dialog box	275
Write Limiter Preset dialog box	275
Write Master EQ Preset dialog box	275
Write Voice Processor Preset dialog box	276
Media mode	277
Storage devices and internal memory	277
Supported device	277
Selecting and deselecting files	277
Searching files	277
Preferences	277
File types	278
Media structure	279
Main page	280
Page structure	280
Navigation tools	280
Load	281
Save	284
Copy	288
Delete	289
Format	290
Utility	290
USB	292
Page menu	293
Care of mass storage devices	294
Merging Samples from various sources	294
SongBook	295
Book	295
Custom List	297
List Edit	298
Book Edit 1	299
Book Edit 2	300
Book Edit 3	301
Info	302
Page menu	302
Lyrics, Score, Markers	304
Selected Player	304
Lyrics page	304
Score page	306
Markers page	307
MIDI	308
What is MIDI?	308
What is MIDI Over USB?	308
Standard MIDI Files	309
The General MIDI standard	309
The Global channel	309
The Chord 1 and Chord 2 channels	309
The Control channel	309
MIDI Presets	309
Connecting Pa900 to a Master keyboard	310

Connecting Pa900 to a MIDI accordion	310
Connecting Pa900 to an external sequencer	311
Playing another instrument with Pa900	312

Appendix

Factory data	314
Styles	314
Style Elements	317
Style and Player controls	317
Single Touch Settings (STS)	317
Sounds	318
DNC Sounds	331
Drum Kits	333
Multisamples	334
Drum Samples	341
Pads	348
Effects	351
MIDI Preset	353
Assignable parameters	354
List of Pedal/Footswitch functions	354
List of Assignable Knob functions	355
List of Assignable Switches functions	356
Scales	356
Effects	357
Dynamic Modulation sources	357
Dynamics (Dynamic)	358
EQ and Filters (EQ/Filter)	361
Overdrive, Amp models, and Mic models (OD Amp Mic)	368
Chorus, Flanger, and Phaser (Cho/Fln Phaser)	373
Modulation and Pitch Shift (Mod./P.Shift)	379
Delay	390
Reverb and Early Reflections (Reverb ER)	400
Mono-Mono Serial (Mono-Mono)	402
Double Size	419
Installing the Korg USB MIDI Driver	428
Connecting Pa900 to a personal computer	428
KORG USB-MIDI Driver system requirements	428
Please note before use	428
Windows: Installing the KORG USB-MIDI Driver	428
Mac OS X: Installing the KORG USB-MIDI Driver	429
MIDI Data	430
MIDI Controllers	430
Recognized chords	431
Replacing the clock backup battery	433
Precautions	433
Installation	433
Installing a microSD card	435
Precautions	435
Installation	435
Accessing the microSD card	436
Removal	436
Shortcuts	437
Troubleshooting	438
Technical specifications	439
MIDI Implementation Chart	440
Index	441

Introduction

Welcome!

Welcome to the world of Korg Pa900 Professional Arranger! Pa900 is one of the most powerful arrangers available today, both for professional and home entertainment use.

Here are some of the features of your new instrument:

Physical Features and User Experience

- 61 semi-weighted keys with velocity and aftertouch.
- Slim and compact, lightweight, elegant cabinet design.
- Wide 7" TFT graphic touch screen display. Professional TouchView™ graphic interface for direct access to the on-screen controls and to the musical resources.
- High-quality two-way integrated amplification, and high-quality output (DAC) audio converters.
- RX (Real eXperience) Technology, the cutting edge engine that drives every aspect of the Pa900 – from the synthesis to the display and how it all works together.
- Three assignable switches, an assignable knob, a joystick and an assignable pedal ensure total control for all the various levels of articulation of the sound.

Sounds and Effects

- Powerful sound generation system, for crystal-clear, realistic sounds.
- DNC (Defined Nuance Control) Sounds, more realistic and vivid than ever.
- 192 MB of Sample memory for User PCM Samples. Sampling function to edit imported Samples.
- 128 voices of polyphony.
- General MIDI Level 2 Sound-compatible. Enhanced Sound compatibility for GM Songs.
- More than 1,100 Sounds, including a Stereo Piano and 77 Drum Kits.
- 320 Performance locations, plus 4 Single Touch Settings (STS) for each Style and SongBook Entry, for fast setting of keyboard sounds and effects.
- Four Stereo Master FX, with 125 effect types, including a selection of fine guitar effects created using Korg's REMS™ (Resonant structure and Electronic circuit Modeling System) technology, to deliver truly great sounding effects.
- Mastering Limiter and Final 4-band Parametric EQ

Styles and Songs

- Over 400 Factory Styles with 4 Variations and 4 Fill In + Break, plus 12 Favorite and 3 User Style banks for unlimited storage of your custom Styles and settings.
- Style and Pad Record, including the enhanced "Guitar Mode 2" for even more realistic guitar parts.
- "Chord Sequencer" function to record on-the-fly any chord progression.
- XDS Double Player with X-Fader. Plays Standard MIDI Files and MP3 files.
- Full-featured 16-track sequencer. Quick Record function to record playing with the Styles.
- Lyrics, Score and Marker display. Multi-lingual extended character set. Enhanced compatibility with Lyrics in graphical format (+G) for Standard MIDI Files and MP3 files.
- MP3 recorder. MP3 player with Vocal Remover.
- Fully editable SongBook music database, for fast song retrieving.

Microphone and Vocal Effects

- High-quality microphone preamplifier, to connect a dynamic microphone.
- Sophisticated TC-Helicon Voice Processor, with dedicated professional effects, including a 3-voice harmonizer.

Other Features

- Search function, for instant retrieving of any musical resource or file.
- Operating System updates, to load new features and enhancements. Don't let your instrument get old!
- Generous internal memory, to store the greatest amount of data, including a slot for an (optional) microSD card.
- USB 2.0 High Speed Host port, for connecting external devices like hard disks, CD-ROM drives, USB memory sticks, etc.
- USB 2.0 High Speed Device port, to connect a personal computer to your Pa900. This port can be used for file transfer or for MIDI connection (without the need of a dedicated MIDI interface for the personal computer).

What's in the box

After you buy your Pa900, please check that all the following items are included in the package. If any of the following items is missing, please contact your Korg dealer immediately.

- Pa900
- Music stand
- Power cable
- Quick Guide
- Accessory Disc (containing the Video manuals, additional manuals, an USB driver)

About this manual

This manual contains all the informations divided in four sections:

- An **Introduction**, containing an overview of the instrument and of basic operations.
- A **Quick Guide**, containing a series of practical guides.
- A **Reference Guide**, with each page and parameter described in detail.
- An **Appendix**, with a list of data and useful information for the advanced user.

In addition, in the DVD that comes with the instrument (as well as in our web site) you will find a multilingual **Video Manual**, showing how to use your Pa900 in easy steps.

Contacts

Your preferred Korg dealer not only delivers this keyboard, but also a whole bunch of hardware and software accessories, as well as service information. You should ask them for any help should you eventually need.

Our international web site is www.korg.com. Korg distributors around the world may have their own web page on the internet. A list of all Korg Distributors can be found in our dedicated web site (www.korg.co.jp/English/Distributors/).

Making a safety copy of your data

Making a safety copy

In case you like to customize your Musical Resources (Sounds, Performances and Styles), we suggest you use the Media > Utility > Backup Resources command to make frequent backup copies into compact archives.

Also, you can use the Media > Save All command to save files that you can separately reload one by one.

Restoring a safety copy

To restore a backup, use the Media > Utility > Restore Resources.

If you saved your data with the Media > Save All command, use the Media > Load operations to reload them.

Restoring the original factory data

In case you want to restore the original factory data, use the Media > Utility > Factory Restore command.

Warning: *This operation will overwrite all the Factory, Local, Favorite and User data!*

Loading the Operating System

Your Pa900 can be constantly updated as new versions of the operating system are released by Korg. You can download the operating system from our [web site](#). Please, read the instructions supplied with the operating system on the site.

You can see which version of the operating systems is installed in your Pa900 by going to the Media > Utility page.

Warning: *Do not install an OS other than the official OS supplied by Korg for the Pa900. Trying to install an OS created for different models or downloaded from unofficial web sites may cause data loss and permanent damage to the instrument. Korg is not responsible for any damage caused by improper installation of the OS.*

Overview

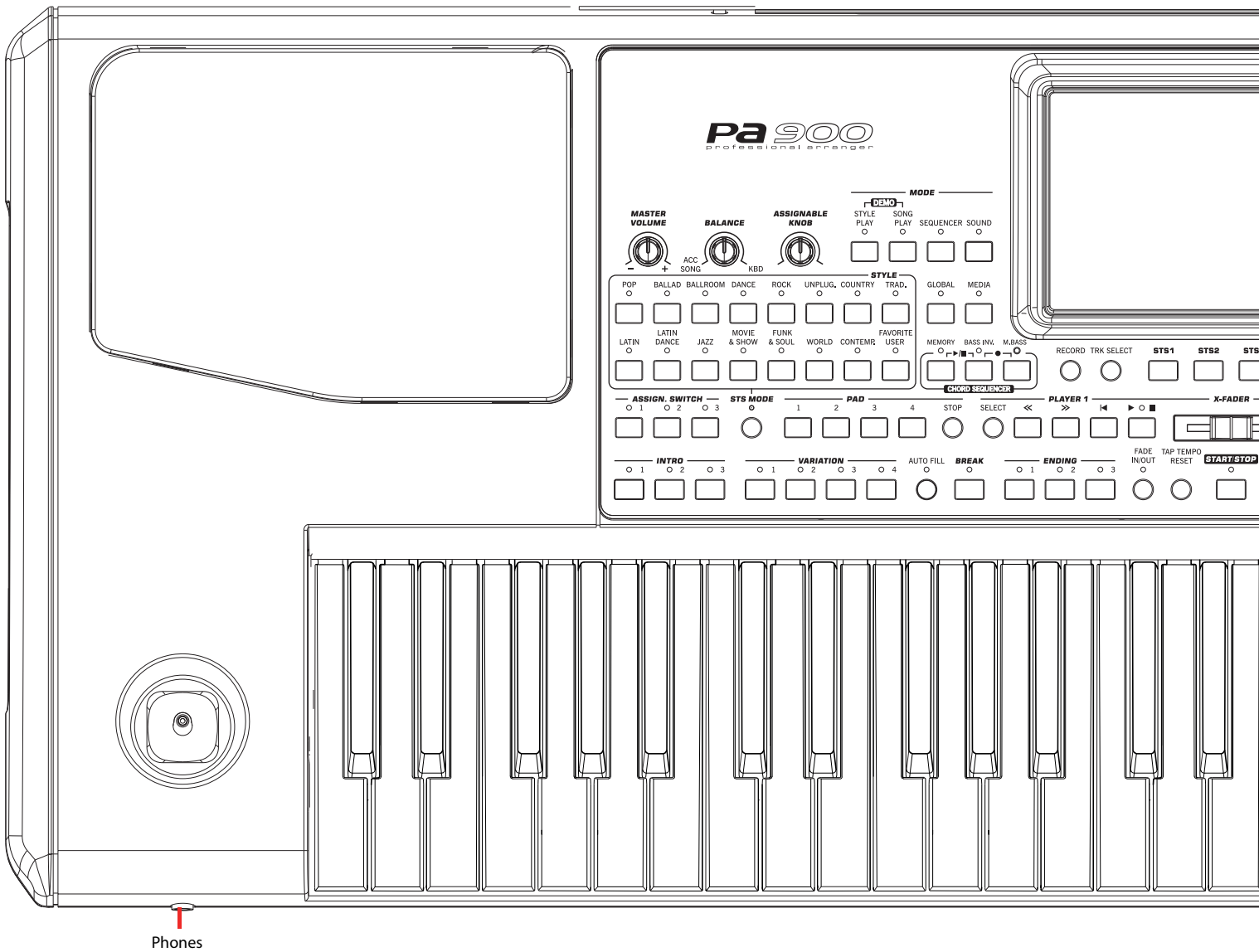

FFront Panel

Speakers

The integrated speakers give a faithful reproduction of the sound of Pa900. They are automatically deactivated when inserting a jack into the PHONES connector. They can be manually deactivated with the “Speakers On/Off” parameter you can find in the Global > Audio & Video > MP3/Speakers page.

Headphones

PHONES

Connect a pair of headphones to this output. You can use headphones with an impedance of 16-200 Ohms (50 Ohms suggested). Use a headphone splitter to connect more than one pair of headphones.

When connecting a jack to this connector, the integrated speakers are automatically turned off. The AUDIO OUT will however continue to work.

Joystick Lever

The joystick is on the left side of the front panel.

JOYSTICK

This joystick triggers different functions, depending on the direction it is moved towards.

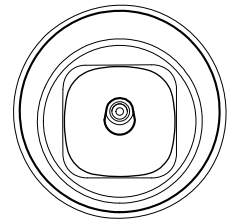

- X (+/-) Move the joystick towards the left (-) to lower the pitch, or towards the right (+) to raise it. This effect is called the Pitch Bend.
- Y+ Move the joystick forward to trigger Modulation

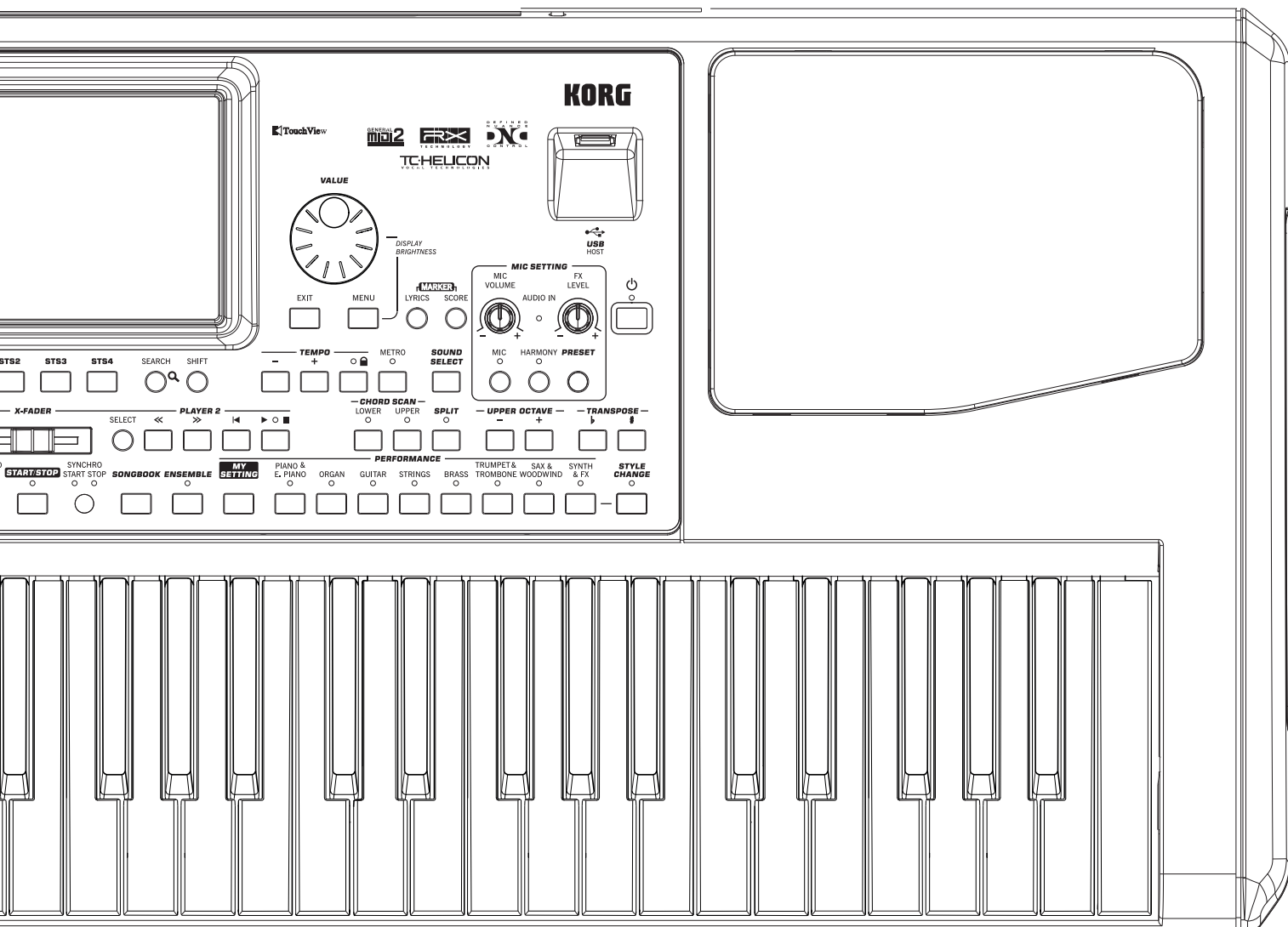

Y- Move the joystick backward, to trigger the function assigned in Sound mode.

Volume Controls

Use these knobs to control the master volume, and to balance between the Keyboard and the Style or the Song.

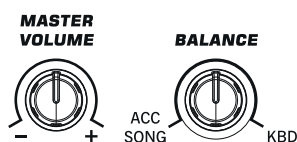

MASTER VOLUME

This knob controls the overall volume of the instrument, both of the integrated speakers, the AUDIO OUT and the PHONES outputs. It also controls the volume of the AUDIO IN inputs in the final mix.

BALANCE

While in Style Play and Song Play mode, this knob usually balances the volume of the Keyboard (KBD) tracks against the Style (ACC, Accompaniment), Song and Pad tracks. This is a relative

control, whose effective maximum value is determined by the MASTER VOLUME knob position.

When moved, a magnified version of a virtual slider appears in the display, for more accurate adjustment.

It can be programmed to work as the volume control for the Accompaniment/Song tracks only, leaving the Keyboard tracks unchanged (in the Controllers > Hand Controllers page of the Global mode).

Note: This does not work in the Sequencer and Sound modes.

Assignable Knob

ASSIGNABLE KNOB

Freely assignable knob, that can be programmed in the Global > Controllers > Hand Controllers page.



Mode Selection

Each of these buttons recalls one of the instrument's operating modes. When selected, each mode excludes all the others.

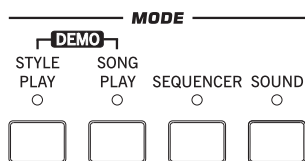

STYLE PLAY

Style Play mode, where you can play Styles (eight tracks of automatic accompaniments) and play up to four Keyboard tracks and four Pad tracks. In the main page, Keyboard tracks are shown on the right half of the display.

You can recall the main page by pressing EXIT from any of the Style Play edit pages. If you are in a different operating mode, press STYLE PLAY to recall the Style Play mode. If Keyboard tracks are not shown in the display, press the TRACK SELECT button to see them.

This operating mode is automatically selected when turning the instrument on. The “My Setting” Performance will be automatically selected.

SONG PLAY

Song Play mode, where you can play back Songs in Standard MIDI File (MID or KAR) or MP3 format. In addition to the Song tracks, you can play up to four Keyboard tracks and four Pads along with the Song(s). In the main page, Keyboard tracks are shown in the right half of the display.

You can recall the main page of this mode by pressing EXIT from any of the Song Play edit pages. If you are in a different operating mode, press SONG PLAY to recall the Song Play mode. Use the TRACK SELECT button to cycle between the Keyboard and Song tracks.

SEQUENCER

Sequencer mode, where you can play, record or edit Songs (in Standard MIDI File format). The Backing Sequence (Quick Record) mode lets you record a new Song based on the Keyboard and Style tracks, and save it as a Standard MIDI File.

Note: While in this mode, you cannot play MP3 files.

SOUND

Sound mode, to play single Sounds on the keyboard, or edit them.

User Sounds may be based on User PCM Samples to be loaded into the dedicated Sample RAM memory.

Note: Pa900 cannot load compressed User PCM Samples from other Pa-Series models.

[SHIFT] While in any other operating mode, keep the SHIFT button pressed and press this button, to send the Sound assigned to the selected track to the Sound mode.

DEMO

Press the STYLE PLAY and SONG PLAY buttons together to select the Demo mode. This mode lets you listen to some Demo

Songs, to let you experience the sonic power of the Pa900. To exit from this mode, press any of the MODE buttons.

Special Mode Buttons

These buttons are used to recall global settings and manage files.

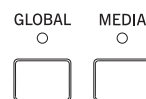

GLOBAL

This button recalls the Global mode, where you can adjust various global settings. Most Global settings are automatically memorized as soon as you edit them. This mode overlaps any operating mode, that will still remain active in the background. Press EXIT to go back to the underlying operating mode.

MEDIA

This button recalls the Media mode, where you can perform various operations on files and storage devices (Load, Save, Format, etc...). This mode overlaps any operating mode, that still remains active in the background. Press EXIT to go back to the underlying operating mode.

The internal memory contains an area where to save data (“DISK [KORG DISK]”).

You can install an (optional) microSD card in the dedicated slot on the back of the instrument, and gain access to the SD unit (“SD [KORG SD]”). See for information on how to install a microSD card.

Style Section

Here you can select a Style, and activate the automatic selection of STSs.

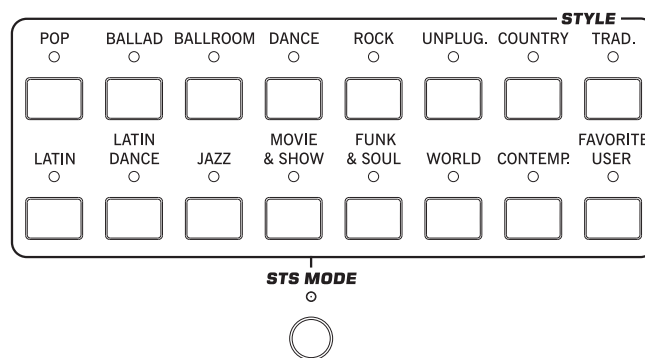

STYLE buttons

Use these buttons to open the Style Select window and choose a Style. See “Style Select window” on page 100.

The FAVORITE/USER button gives access to twelve Favorite Style banks and three User Style banks. You can use User locations to temporarily load new Styles from an external device, or save newly created or edited Styles.

Favorite locations, too, can be used to load new Styles from an external device, or to save newly created or edited Styles, but in addition you can edit the names of these Style banks, so that you can create a custom set of Styles. See “The Favorite banks” on page 129.

Each button (Style banks) contains five pages, each with up to eight Styles. Repeatedly press a STYLE button to cycle between the available pages.

 By keeping one of these buttons pressed for about one second, the “Write Current Style Settings” dialog box will appear.

STS MODE

This button lets you cycle between the following functions.

- On When a Style is selected, STS 1 is also automatically selected. The Keyboard’s sounds and effects will change, along with the Style’s sounds and effects.
- Flashing Variation/STS Link function activated. This function makes each Variation recall the corresponding STS when selected. For example, select Variation 2, and STS 2 will be automatically recalled; select Variation 3, and STS 3 will be automatically recalled.
- Off When you select a Style, the Style’s sounds and effects will change. The Keyboard’s sounds and effects will not change.

Memory, Bass Inversion, Manual Bass, Chord Sequencer

These buttons let you decide what should remain in memory, and how to play the bass. In addition, they have the Chord Sequencer as a second function.

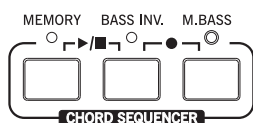

MEMORY

This button allows you to choose whether the Lower notes and/or chord triggering the accompaniment will remain in memory after raising your hand from the keyboard.

- On Depending on the setting of the “Memory Mode” parameter (in the Global > Mode Preferences > Style), the sound on the left of the split point (Lower), and/or the chords for the automatic accompaniment can kept in memory even when you raise your hand from the keyboard.
- Off Both the sound and chord are released as soon as you raise your hand from the keyboard.

Note: This function can be automatically activated by playing the keyboard harder, by setting the “Velocity Control” parameter (in the Global > Mode Preferences > Style page).

 You can jump to the Global > Mode Preferences > Style page by keeping SHIFT pressed and pressing the MEMORY button.

BASS INV. (Bass Inversion)

This button turns the Bass Inversion function on or off.

- On The lowest note of a chord played in inverted form will always be detected as the root note of

the chord. Thus, you can specify to the arranger composite chords such as “Am7/G” or “F/C”.

- Off The lowest note is scanned together with the other chord notes, and is not always considered as the root note.

Note: This function can be automatically activated by playing the keyboard harder. See “Velocity Control” on page 252.

M. BASS (Manual Bass)

This button turns the Manual Bass function on or off.

- On The automatic accompaniment stops playing (except for the Drum and Percussion tracks), and you can manually play the Bass track on the Lower part of the keyboard. You can start the automatic accompaniment again after pressing this button to turn off the Manual Bass function.
- Off The bass track is automatically played by the Style.

Note: When you press the MANUAL BASS button, the Bass track volume is automatically set to its maximum value. The volume is automatically set back to the original value when the MANUAL BASS button is deactivated.

CHORD SEQUENCER (PLAY/STOP AND RECORD)

While a Style is in play, you can use this section as a Chord Sequencer and record a looping sequence of chords. The chords will drive the arranger, leaving your hands free for solo playing.

RECORD (BASS INV. + M. BASS): Press these buttons together to start recording the Chord Sequence. Recording will start from the next measure. Press these buttons again to stop recording.

PLAY/STOP (MEMORY + BASS INV.): Press these buttons together to let the Chord Sequence play in loop, and automatically drive the arranger. The Chord Sequence will start on the next measure. Press these buttons again to stop the sequence.

The Chord Sequence will remain in memory up until you record a new Chord Sequence, or you turn the Pa900 off.

Record, Track Select

Use the RECORD and TRACK SELECT buttons to create or edit Styles, Songs or Sounds, or select track groups.



RECORD

This button sets the instrument to the Record mode (which one depends on the current operating mode).

TRACK SELECT

Depending on the operating mode, this button switches between the various track views.

STYLE PLAY MODE

Toggles between Keyboard and Style tracks.

SONG PLAY MODE

Toggles between Keyboard tracks, Song tracks 1-8, and Song tracks 9-16.

SEQUENCER MODE

Toggles between Song tracks 1-8 and Song tracks 9-16.

STS Section

Use the STS (Single Touch Settings) buttons to assign Sounds to the keyboard.

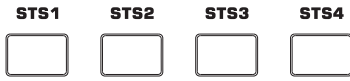

STS 1-4 buttons

These buttons allow to select up to four Single Touch Settings (abbreviated as STS). Each of the Styles and SongBook Entries includes four Single Touch Settings (STS), to automatically configure Keyboard tracks and effects at the touch of a finger.

By keeping one of these buttons pressed for about one second, the “Write Single Touch Setting” dialog box will appear.

Note: STS contained inside Factory Styles are usually write-protected (unless you uncheck the “Factory Style and Pad Protect” option in the Global > Mode Preferences > Media page)

Search, Shift

Use the SEARCH and SHIFT buttons to search the memory’s content or activate a button’s seconds function.

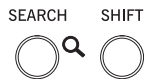

SEARCH

Press this button to open the Search window, and look for a specified file or musical resource. The Search window appears slightly different depending on the context.

SHIFT

With this button held down, pressing certain other buttons gives access to a second function. The list of shortcuts is in the Appendix.

Assignable Switches

ASSIGNABLE SWITCH

Freely assignable switches, that can be programmed in the Pad/Assignable Switch > Switch page of the Style Play or Song Play mode.

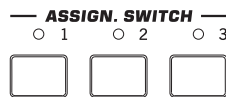

Pads

Here you can play (and stop) the Pads, i.e. single sounds or looping sequences.

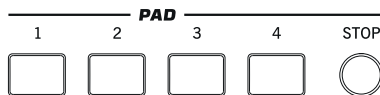

PAD 1-4 STOP

Each Pad button corresponds to a dedicated Pad track. Use these buttons to trigger up to four sounds or sequences at the same time.

- Press a single PAD button to trigger a single sound or sequence.
- Press more PAD buttons to trigger several sounds or sequences.

Sequences will play up to the end. Then, they will stop or continue repeating, depending on their “One Shot/Loop” status (see the “Pad Type” parameter in the Pad Record mode).

You can stop all sounds or sequences at the same time, or just some of them:

- Press STOP (in the PAD section) to stop all sequences at once.
- Press a single PAD button to stop the corresponding sequence.

About Pad synchronization. In Style Play mode, Pads are synchronized to the Style’s Tempo. In Song Play mode, they are synchronized to the latest Player you set to play. For example, assume you pressed PLAYER 2-PLAY; when pressing one of the PAD buttons, it will play in sync with Player 2.

Note: There is no synchronization with MP3 files. Pads can only be synchronized to the Tempo of the latest selected Standard MIDI Files. Therefore, when an MP3 file is assigned to the latest select Player, Pads will synchronize to the Tempo of the latest Standard MIDI File that has been played back.

About the Play command of Players and the Pads. When you press one of the PLAY buttons to start the corresponding Player, all Pads will stop playing.

SHIFT You can jump to the Style Play > Pad/Assignable Switch page by keeping SHIFT pressed, and pressing one of the PAD buttons.

Players Controls

Pa900 is equipped with two players (Player 1 and Player 2), each with its own set of transport controls. The Player 1 group is also used for the Sequencer mode.



SELECT

Press this button to open the Song Select window and choose a Song. This is the same as touching the Song name in the display.

<< and >>

Rewind and Fast Forward commands. If you use them while the Song is in play, they make it scroll back or forward.

When pressed once, these buttons move the Song to the previous or following measure (with a Standard MIDI File) or to the previous or next second (with an MP3 file). When kept pressed, they make the Song scroll continuously, until you release them.

In Sequencer mode, if you set a “Start from” measure other than 1, when pressing the << button the Song rewinds up to that measure instead of the first one (see “Start from” on page 178).

[SHIFT] In Jukebox mode (Player 1), keep the SHIFT button pressed, and press these buttons to scroll to the previous or next Song in the Jukebox list (see “Jukebox Editor” on page 175).

◀ (HOME)

Sends the Song Position back to the beginning of the Song.

In Sequencer mode, if you set a “Start from” measure other than 1, the Song Position goes back to that measure (see “Start from” on page 178).

▶/■ (PLAY/STOP)

Starts or stops the Song from the current Song Position.

[SHIFT] In Song Play mode, pressed while keeping SHIFT pressed, starts both players at the same time.

X-FADER



In Song Play mode, this slider balances the volume of the two on-board Players. When fully on the left, only Player 1 can be heard. When fully on the right, only Player 2 can be heard. When in the middle, both Players play at full volume.

This slider also selects the Lyrics, Score and Markers from one of the Players.

Note: This slider does not work in Style Play, Sequencer or Sound mode.

PLAYER 2 TRANSPORT CONTROLS

Transport controls for Player 2. See instructions for Player 1 above.

Style Elements

This section contains the separate elements of a Style (Intro, Variation, etc.).

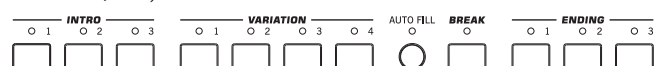

INTRO 1-3 buttons

These buttons turn the corresponding Intro on. After pressing one of these buttons, start the Style, and it will begin with the selected Intro. The INTRO LED will automatically go off at the end of the Intro.

At the end of the Intro, the Variation whose LED was blinking will be selected.

Press one of the INTRO buttons twice (LED blinking) to let the corresponding Intro play in loop, and select any other Style element (Intro, Variation, Ending) to exit the loop (or press the same button again).

Note: Intro 1 plays a sequence including a chord progression, while Intro 2 plays a fixed chord. Intro 3 is usually a one-bar Count In.

VARIATION 1-4 buttons

Each of these buttons selects one of the four Variations of the current Style. The higher the Variation number, the denser the arrangement.

[SHIFT] You can jump to the Style Play > Drum Map page by keeping SHIFT pressed and pressing one of the VARIATION buttons.

AUTO FILL

This button allows to turn the Auto Fill function on or off.

On When selecting a different Variation, the Fill having the same number of the previous Variation is automatically selected. For example, if going from Variation 2 to Variation 3, Fill 2 is automatically selected.

Off When choosing a Variation, no fill is selected.

BREAK

This button triggers a break. Press it twice (LED blinking) to let it play in loop. Press it again or select any other Style Element (Intro, Variation, Ending) to exit from the loop.

ENDING 1-3 buttons

While the Style is running, these three buttons trigger an Ending, and stop the Style. Press one of them, and the Style will stop running with an Ending.

Press them twice (LED blinking) to let them play in loop, and select any other Style element (Intro, Variation...) to exit the loop (or press the same button again).

Note: Ending 1 plays a sequence including a chord progression, while Ending 2 plays a fixed chord. Ending 3 starts immediately, and is just two measures long.

Style Controls

Use these buttons to start/stop the accompaniment.



FADE IN/OUT

When a Style or Song is not playing, press this button to start it with the volume “fading in” (the volume goes from zero to maximum).

When a Style or Song is playing back, press this button to stop it with the volume “fading out” (the volume gradually decreases).

You don’t need to press START/STOP or PLAY/STOP to start or stop the Style or Song.

Note: This does not work in Sequencer mode.

[SHIFT] You can jump to the Global > General Controls page by keeping SHIFT pressed and pressing the FADE IN/OUT button.

TAP TEMPO/RESET

This is a double-function button, acting in a different way depending on whether the Style is running or not.

Note: This button only works while in Style Play mode.

Tap Tempo: When the Style is not playing, you can “beat” the tempo on this button. Tap as many times as the Time Signature’s numerator (for example, four times with a 4/4 Time Signature, or three times with a 3/4 one). At the end, the accompaniment starts playing, using the “tapped in” tempo.

Reset: If you press this button while the Style is playing back, the Style pattern goes immediately back to the beginning of measure 1.

START/STOP

Starts or stops the Style.

Note: This function can be automatically activated by playing the keyboard harder, by setting the “Velocity Control” parameter (in the Global > Mode Preferences > Style page).

SHIFT You can reset all ‘frozen’ notes and controllers on the Pa900 and any instrument connected to its MIDI OUT or the USB Device port, by using the “Panic” (**SHIFT** + **START/STOP**) key combination. Just press **SHIFT** + **START/STOP** to stop all notes and reset all controllers.

SYNCHRO START / STOP button

These buttons turn the Synchro Start and Synchro Stop functions on or off. With this feature, you can choose to press the **START/STOP** button to start and/or stop a Style, or just play the keyboard in the Chord Scan area.

Note: This button only works while in Style Play mode.

Start On, Stop Off

In this situation, just play a chord in the chord recognition area to automatically start the Style. If you like, turn one of the **INTROs** on before starting the Style.

Start On, Stop On

When both LEDs are lit, raising your hands from the keyboard will momentarily stop the Style. If you play a chord again, the Style will start again.

Start Off, Stop On

In this case, raising your hands from the keyboard will stop the Style.

Start Off, Stop Off

All Synchro functions are turned off.

SHIFT You can jump to the Global > MIDI > General Control by keeping the **SHIFT** button pressed and pressing the **SYNCHRO START/STOP** button.

SongBook

SONGBOOK

The SongBook is a database of song titles, that can automatically choose the more appropriate Style, Standard MIDI File or MP3 file for you.



SONGBOOK

While you are in Style Play or Song Play mode, press this button to open the SongBook. While the SongBook is shown on the display, you can browse through the music database.

By By keeping this button pressed for about one second, a new SongBook Entry with the current settings is added to the database. You will be able to give it a name and save.

SHIFT You can jump to the SongBook > Custom List page by keeping **SHIFT** pressed and pressing the **SONGBOOK** button.

Ensemble

ENSEMBLE



The Ensemble function automatically harmonizes the melody you play with your right hand.

ENSEMBLE

This button turns the Ensemble function on or off. When on, the right-hand melody is harmonized with the left-hand chords.

Note: The Ensemble function only works when the keyboard is in **SPLIT** mode.

SHIFT You can jump to the Style Play > Keyboard/Ensemble page by keeping **SHIFT** pressed and pressing the **ENSEMBLE** button.

Display and Brightness Controls

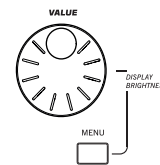

COLOR TOUCHVIEW™ GRAPHICAL DISPLAY

Use this display to interact with the instrument. To adjust the display brightness, keep the **MENU** button pressed, and turn the **DIAL** counter-clockwise to make the display darker, or clockwise to make it brighter.

Data Entry and Navigation

The **VALUE DIAL** can be used to assign a different value to the parameter selected in the display, or to scroll a list of files in the Song Select, SongBook, Search and Media pages.

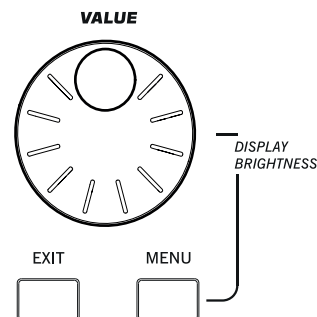

VALUE DIAL

Turn the dial clockwise to increase the value of the selected parameter. Turn it counter-clockwise to decrease its value.

MENU When used while pressing the **MENU** button, this control always acts as a Display Brightness control.

EXIT

Use this button to perform various actions, leaving from the current status:

- Exit the Edit menu page, without selecting any item.
- Make the page menu disappear, without selecting any item.
- Return to the main page of the current operating mode.
- Exit the Global or Media edit environment, and return to the current page of the current operating mode.
- Exit from the SongBook mode.
- Exit from the Lyrics, Score and Marker pages.
- Exit from a Style, Pad, Performance or Sound Select window.

MENU

This button opens the edit menu page for the current operating mode. After opening an edit menu, you can jump to one of the edit sections by touching the corresponding button in the display.

Otherwise, press EXIT to return to the main page of the current operating mode, or the current page of the underlying operating mode.

Lyrics, Score, Marker

Use these buttons to access the Lyrics, Score or Marker pages. Use the X-Fader to select either Player 1 or Player 2.



LYRICS

This button recalls the Lyrics page for the Song or the Style.

SCORE

Press this button to open the Score page (in Song Play mode).

MARKER

Press both the LYRICS and SCORE buttons together to open the Marker page (in Song Play mode).

Tempo Section

The TEMPO and METRO buttons can be used to control the Tempo and the Metronome.

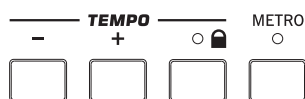

TEMPO +/- buttons

TEMPO- decreases the speed of the Style or Song. TEMPO+ increases it.

Press both buttons together to reset the Tempo to the value memorized in the Style or Standard MIDI File. With MP3 files, the original speed of the file is recalled (value reset to "0").

TEMPO LOCK

This button turns the Tempo Lock function on or off.

On When you select a different Style or Performance, or select a different Song, the Tempo will not change. You can still manually change it, by using the TEMPO +/- buttons, or select the Tempo value and change it by using the VALUE dial.

Off When you select a different Style or Performance, or select a different Song, the memorized Tempo will be automatically selected.

Note: This button does not work with MP3 files.

(SHIFT) You can jump to the Global > General Controls > Lock page by keeping SHIFT pressed and pressing this button.

METRO

Use this button to turn the Metronome on or off.

(SHIFT) You can jump to the Global > General Controls > Basic page by keeping SHIFT pressed, and pressing this button.

Sound Select

SOUND SELECT

Use this button to open the Sound Select window and select a Sound to be assigned to the selected track. This is the same as touching a Sound name in the display. Repeatedly press it to cycle between the Sound bank pages.

For each type of Sounds there are several Sound banks, that can be selected by touching the side tabs. Each Sound bank contains various pages, each with up to eight Sounds, that can be selected by touching the lower tabs.

Sounds of the **Factory** type are usually write-protected (unless you uncheck the "Factory Sound Protect" option in the Global > Mode Preferences > Media page). Sounds of the **Legacy** type are standard Factory Sounds allowing greater compatibility with older Pa-Series instruments. Factory Sounds of the **GM** type allow for compatibility with General MIDI sounds. Sounds of the **User** type are locations where you can load new Sounds from an external device, or save new or edited Sounds. The **User DK** type is where you can load new Drum Kits, or save new or edited Drum Kits.

Chord Scan and Keyboard Split

Use these buttons to choose chord recognition and keyboard splitting.

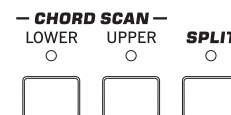

CHORD SCAN section

In Style Play, Song Play and Sequencer-Backing Sequence mode, use these buttons to define the way chords are recognized.

LOWER Chords are detected below the split point. The number of notes you should play to form a chord is defined by the Chord Scan Mode parameter (see "Chord Recognition" on page 252).

UPPER Chords are detected above the split point. You must always play three or more notes to let the arranger recognize a chord.

FULL (both LEDs On)

Chords are detected on the full keyboard range. You must always play three or more notes to let the arranger recognize a chord. (You can use this mode even when the Split keyboard mode is selected). A Fingered or Expert Chord Recognition Mode is automatically selected (see “Chord Recognition” on page 252).

OFF No chords detected. After pressing START/STOP, only the Drum and Percussion accompaniment tracks will play.

SPLIT

In Style Play, Song Play and Sequencer-Backing Sequence mode, use this button to define how the four Keyboard tracks are positioned on the keyboard, and how chords are recognized by the arranger.

Note: One of the Chord Scan options must be selected for the accompaniment to play.

On The Lower track plays below the split point, while the Upper 1, Upper 2 and Upper 3 tracks play above it. This is called the **Split** keyboard mode.

By default, turning on the Split mode automatically selects the Lower chord scanning mode (see above). In this mode, chords are detected below the split point. The number of notes you should play to form a chord is defined by the “Chord Recognition” parameter (see page 252).

Off The Upper 1, Upper 2 and/or Upper 3 tracks play over the whole keyboard range. The Lower track does not play. This is also called the **Full** keyboard mode.

By default, turning off the Split mode automatically selects the Full chord scanning mode (see above). In this mode, chords are detected over the full keyboard range. You must always play three or more notes to let the arranger recognize a chord (see “Chord Recognition” on page 252).

By keeping this button pressed for about one second, the Split Point window appears. When there, play the new split point on the keyboard.

Transpose Section

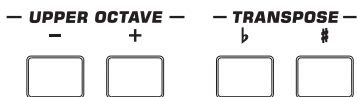

Use these buttons to transpose the Sounds.

UPPER OCTAVE

Use these buttons to transpose the Upper tracks in steps of one whole octave (12 semitones; max ±3 octaves). The octave transposition value is always shown (in octaves) next to the Sound's name.



Press both buttons together, to reset the Octave Transpose to the saved value.

- Lowers the selected track by one octave.

+ Raises the selected track by one octave.

SHIFT You can jump to the Style Play > Mixer/Tuning > Tuning page by keeping SHIFT pressed and pressing one of the UPPER OCTAVE buttons. **Hint:** Go to the Tuning page to separately transpose each track.

TRANPOSE

These buttons transpose the whole instrument in steps of one semitone (Master Transpose). The transpose value is usually shown in the page header.



Press both buttons together, to reset the Master Transpose to zero.

Note: You can also transpose MP3 files. Keep in mind, however, that transposition always remains inside the range -5...+6 semitones. This range is enough to cover all keys, but allows to avoid excessive audio degradation. Any further transposing will be reversed to fit the range. So, you might see a +7 transpose value (Just Fifth Up) shown in the display, but the MP3 will actually play 5 semitones lower (Just Fourth Down).

b Lowers the Master Transpose in steps of one semitone.

Raises the Master Transpose in steps of one semitone.

SHIFT You can jump to the Global > Tuning > Transpose Control page by keeping SHIFT pressed, and pressing one of the TRANPOSE buttons.

Performance Select Section

Use these buttons to select a Performance. Performances memorize all Sounds assigned to the keyboard, most control panel settings, and an associated Style.

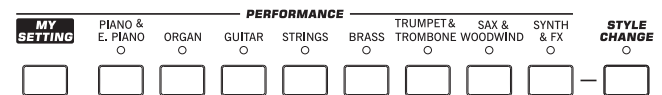

MY SETTING

This is a special direct-access Performance, that is automatically selected when the instrument is turned on. When pressing this button, the Performance is immediately selected.

Keep this button pressed for about one second to save the current settings into the My Setting Performance.

PERFORMANCE buttons

Use these buttons to open the Performance Select window, and select a Performance.

Each Performance bank contains five pages, each with up to eight Performances. Repeatedly press a PERFORMANCE button to cycle between the available pages.

All Performances can be freely customized, by accessing the edit pages of the Style Play and Song Play modes by pressing the MENU button.

By keeping one of these buttons pressed for about one second, the “Write Performance” dialog box will appear.

STYLE CHANGE

This button turns the Style Change function on or off.

- On When you select a Performance, the Style might change according to which Style is memorized onto the Performance.
- Off When you select a Performance, the Style will remain the same. Only Keyboard tracks (Sounds, Effects...) will be changed.

Mic Setting Section

Use these buttons to check the audio input level, set the volume of the microphone input and effects, and turn the microphone and harmony voices on or off.

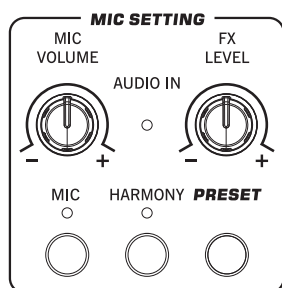

AUDIO IN LED

This LED shows the level of the audio signal entering the AUDIO IN connectors (either mic or line). Three different colors (green, orange, red) show the level. Try to keep the level so that this LED remains on green most of the time, with orange appearing at signal peaks. Never go to red.

- Off: No signal entering.
- Green: Low- to mid-level signal entering. If the LED turns off too often, the input gain is too low. When a microphone is connected to the LEFT connector, use the MIC GAIN control to increase the input level. When a line-level device is connected, use the source device's own volume control.
- Orange: Slight overload in the signal path. This is fine if it turns on only on signal peaks.
- Red: Clipping is occurring in the signal path. Use the MIC GAIN control and/or the source device's volume control to lower the input level.

See "AUDIO IN Section" on page 20 for more information on the AUDIO IN connectors.

MIC VOLUME

Use this knob to set the overall volume of the microphone signal (including the Voice Processor effects). This is equivalent to the MIC/IN track you can see in the Volume pane of the main display.

FX LEVEL

Use this knob to set the volume of the Delay and Reverb sections of the Voice Processor.

MIC ON/OFF

Press this button to turn the microphone input on or off. The LED shows the status of the microphone section.

[SHIFT] If you keep the SHIFT button pressed, and press this button, the Global > Mic > Global Setup page will appear (see "Mic: Global Setup" on page 454).

HARMONY

Turns the Voice Harmony effect on or off. This adds harmonization voices to the lead voice.

[SHIFT] If you keep the SHIFT button pressed, and press this button, the Global > Mic > Harmony page will appear (see "Mic: Harmony" on page 450).

PRESET

Use this button to open the Voice Processor Preset Select window and select a Preset to be assigned to the microphone signal entering the LEFT input. This is the same as touching a Preset name in the display.

For each type of Preset there are several Preset banks, that can be selected by touching the side tabs. Each Preset bank may contain up to eight Presets.

[L] By keeping this button pressed for about one second, the "Write Voice Processor Preset" dialog box will appear.

USB Host connector

Use this connector to connect USB mass storage devices.

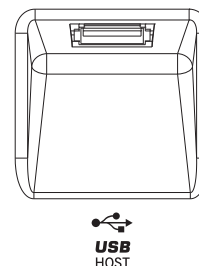

USB HOST(F) CONNECTOR

This is a USB Type A (Master/Host) connector, USB 2.0 compliant (High Speed). Use it to connect to the Pa900 an USB Flash Memory stick, an external CD-ROM drive, an USB hard disk. To access the connected device, go to the Media edit mode (see "Media mode" on page 277).

Standby On/Off



STANDBY

Use this button to let the instrument exit (LED off) or enter (LED on) standby.

Press it briefly to let the instrument exit standby. In case there are User Sounds based on User PCM Samples, loading may take some time.

Keep it pressed for about one second to let it enter standby.

Warning: When the instrument is in standby mode, it is still connected to the power line. Accessing the inside of the instrument can be dangerous. To completely disconnect the instrument from the power, unplug the power plug from the power socket on the wall.

Note: To avoid wasting power, Pa900 will by default automatically enter standby mode after two hours of non-active use (playing, pressing buttons or using the touch-screen). Please save your data (Performances, Styles, Songs, and so on) before taking a prolonged pause. You can change the auto power-off timer in Global > General Controls > Clock & Power.

Rear Panel

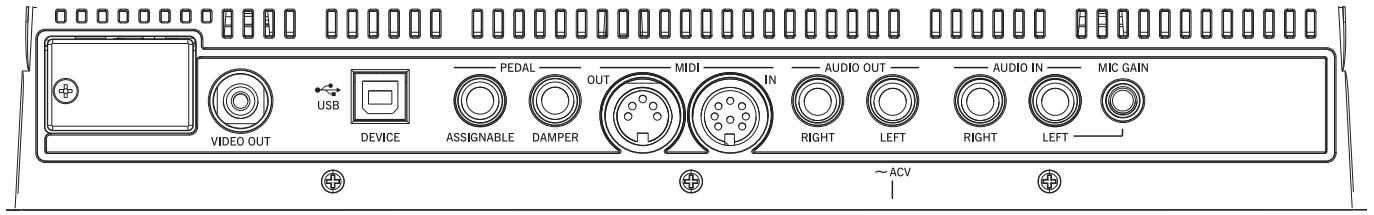

Music stand

Music stand holes

A music stand comes standard with your Pa900. Insert its legs into these two dedicated holes.

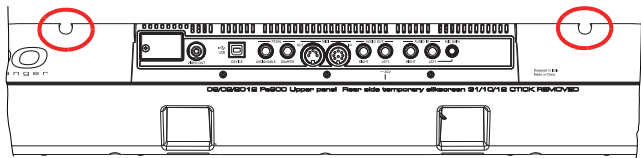

Video

VIDEO OUT

You can connect Pa900 to a TV or video monitor.

Pa900 is compatible with the NTSC, PAL and SECAM TV standard. When connecting a SECAM-compliant TV set, select the PAL standard. However, in this latter case, the image will be shown in black and white.



1. Connect the instrument's video output to the video input of the television set. Depending on the type of television set, you can use a cable of the type "RCA-to-RCA" (if the television set is equipped with a Video Composite input), or "RCA-to-SCART" (if the television set is equipped with a SCART connector). You can buy the needed cables at a store that sells television equipment.
2. Turn the instrument on, and press the GLOBAL button to gain access to the Global mode. Go to the Audio & Video > Video Out page, and select the video standard (PAL or NTSC).
3. Turn the television set on, and tune it on the correct AV input.
4. In the same page of the Global, use the Colors parameter to choose the preferred set of colors for the lyrics and the background.

USB Device Connector

Use this connector to connect Pa900 to a personal computer.

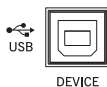

DEVICE

This is a USB Type B (Slave/Device) connector, USB 2.0 (High Speed). Use it to connect the Pa900 to a personal computer, and transfer data to/from its internal memory (Disk). You can enable USB connection in the "USB" page of the Media mode.

MIDI over USB is supported, so you can use this connector instead of the MIDI ports. The drivers for PC and Mac, needed to make full use of this type of connection, are supplied in the Accessory Disc that comes with the instrument, or can be downloaded from our [web site](#).

Pedals

Use these connectors to connect various types of pedals.

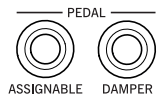

ASSIGNABLE

Use this port to connect a continuous- or footswitch-type pedal, like the (optional) Korg EXP-2, XVP10, PS-1 or PS-3. To program and calibrate it, go to the Controllers > Foot Controllers page of the Global mode.

DAMPER

Use this to connect a Damper pedal, like the (optional) Korg PS1, PS3 or DS1H. To change its polarity and calibrate it, go to the Controllers > Foot Controllers page of the Global mode.

Note: Half-pedalling on Piano Sounds is available when connecting a DS1H Damper pedal.

MIDI Interface

The MIDI interface allows your Pa900 to be connected to external controllers (master keyboard, MIDI guitar, wind controller, MIDI accordion...), to a series of expanders, or to a computer running a sequencer.

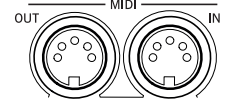

OUT

This connector sends MIDI data generated by Pa900's keyboard, controllers, and/or the internal player. Connect it to an expander's or computer's MIDI IN.

IN

This connector receives MIDI data from a computer or a controller. Connect it to an external controller's or computer's MIDI OUT.

AUDIO OUT Section

Use these connectors to send the audio signal (sound) to a mixer, a PA system, a set of powered monitors, or your hi-fi system.



LEFT, RIGHT

Use these line-level outputs to send the final stereo mix to an external device. Connect either of them to output the signal in mono. Adjust the output level with the MASTER VOLUME knob.

Connect two mono cables to these outputs. Connect the other end of the cables to a stereo channel of your mixer, two mono channels, two powered monitors, or the CD, LINE IN or TAPE/AUX input of your audio system. Don't use the PHONO inputs of your audio system!

Connecting a jack to these outputs will not deactivate the integrated speakers. This way, you can continue to monitor your playing, while the signal is sent to the main mixer.

AUDIO IN Section

Use these connectors to connect a dynamic microphone, another keyboard/synthesizer, or a CD player.

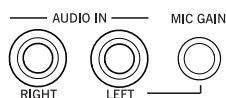

LEFT, RIGHT

Use these connectors to connect a line-level input source, such as a CD player or a synthesizer, or a dynamic microphone. The signal routing, and the correct impedance for these inputs, can be selected with the “Input Routing” parameter in the Global > Audio & Video > Audio In page (see page 264).

- When the “Input Routing” parameter is set to “Left In to Voice Processor”, you can connect a dynamic microphone to the LEFT audio input, and a mono line-level source to the RIGHT audio input. Use the MIC GAIN knob to adjust the input gain. Set the volume level of the microphone signal in the mix by using the

MIC VOLUME knob, while watching at the AUDIO IN LED on the control panel (see “Mic Setting Section” on page 17).

- When the “Input Routing” parameter is set to “Audio Ins to Direct Out”, you can connect a line-level input source to the LEFT and RIGHT audio inputs. Use the source's output volume control to adjust the input level, while watching at the AUDIO IN LED on the control panel.

MIC GAIN

Use this controls to adjust the input sensitivity of the LEFT connector (from 0 to +40dB) when it is set to the microphone input sensitivity (see above). You can check the input level by watching at the AUDIO IN LED on the control panel (see “Mic Setting Section” on page 17).

Power

This is where you connect Pa900 to the power line.

ACV cable connector

Plug the supplied AC cable into this connector. When the cable is connected, the instrument is in standby mode. To let it enter or exit standby, use the STANDBY switch located on the front panel.

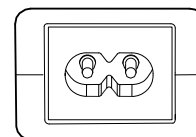

Warning: When the instrument is in standby mode, it is still connected to the power line. Accessing the inside of the instrument can be dangerous. To completely disconnect the instrument from the power, unplug the power plug from the power socket on the wall.

Start up

Connecting the AC power cord

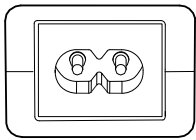

Connect the supplied power cord to the dedicated socket on the rear of the instrument. Then, plug it into a wall socket. You don't need to worry about the local voltage, since the Pa900 uses a universal power adapter.

When the cable is connected to the power, the instrument automatically enters standby mode.

Turning the instrument on (or in standby)

Press the STANDBY button on the front panel to let the instrument exit standby. The display will light up, showing the boot procedure.



Note: When the instrument exits standby, User PCM Samples used by some User Sounds may be automatically loaded. Loading them may take some time.

Keep the STANDBY button pressed for about one second to let the instrument enter standby.

Warning: When putting the instrument in standby, all data contained in RAM (Song recorded or edited in Sequencer mode, the Chord Sequence, Samples in edit and not yet saved) will be lost. MIDI Grooves generated by the Time Slice function will be lost, too.

On the contrary, data contained in the internal memory (Factory data, User Sounds, Performances, Styles and Multisamples) will be preserved. Saved Samples will be preserved as well.

Controlling the Volume

Master Volume



Use the MASTER VOLUME knob to control the overall volume of the instrument. This knob controls the volume of the sound going to the integrated speakers, the AUDIO OUT and PHONES connectors.

Note: Begin at a moderate level, then raise the MASTER VOLUME up. Don't keep the volume at an uncomfortable level for too long.

Keyboard, Style Accompaniment and Song Volume

By default, the BALANCE knob balances the volume of the Keyboard (KBD) tracks, against the Style's Accompaniment (ACC), Song and Pad tracks.



- When in Style Play mode, this knob balances between the Keyboard tracks, and the Style and Pad tracks.
- When in Song Play mode, this knob balances between the Keyboard tracks, and the Player and Pad tracks.

This is a relative control, whose effective maximum level is determined by the MASTER VOLUME knob position.

When moved, a magnified version of the virtual slider appears in the display, for more accurate positioning.

As an alternative, the knob can be used to control the Style/Song Volume without affecting the Keyboard tracks (choose the desired behavior by editing the "Balance Control" parameter in the Global > Controllers > Hand Control page).

Note: This knob only works in Style Play and Song Play mode; it does not work in Sequencer mode.

The X-Fader slider

The X-FADER slider sets the relative volume of the two onboard players (Player 1 and Player 2).



- Move it fully to the left to set Player 1 to the maximum level and Player 2 to zero.
- Move it fully to the right to set Player 1 to zero and Player 2 to the maximum level.
- Move it to the center to set both Players at the same level.

This slider also selects the Harmony source, as well as the Lyrics, Score and Markers of one of the two players.

Headphones

Connect a pair of headphones to the PHONES output, on the left side of the keyboard (under the joystick). You can use headphones with an impedance of 16-200 Ohms (50 Ohms suggested). Use a headphone splitter to connect more than one pair of headphones.

Note: When connecting the headphones, the speakers are automatically deactivated.

Loudspeakers

Pa900 is fitted with four powerful, high-quality integrated speakers and a bass-reflex box, powered by a 20+20 Watt amplification system.

The overall volume can be controlled via the MASTER VOLUME knob.

Speakers can be deactivated with the “Speakers On/Off” parameter, that you can find in the Global > Audio & Video: MP3/Speakers page.

Audio Outputs

Audio outputs allow for connecting Pa900 to an external amplification system. The overall volume can be controlled via the MASTER VOLUME knob.

MIDI connections

You can play the internal sounds of your Pa900 with an external controller, i.e. a master keyboard, a MIDI guitar, a wind controller, a MIDI accordion, or a digital piano.

You can also control other MIDI devices with Pa900, or connect it to a computer for use with an external sequencer.

As an alternative to the MIDI connectors, you can use the USB Device port for direct connection to a personal computer.

See the “MIDI” chapter on page 308 for more information on MIDI connections.

Damper pedal

Connect a Damper (Sustain) pedal to the DAMPER connector on the back panel. Use an (optional) Korg PS1, PS3 or DS1H footswitch pedal, or a compatible one. With the Korg DS1H, half-pedalling can be used on some Grand Piano sounds. To calibrate and switch the Damper polarity, go to the Controllers > Foot Controller page of the Global mode.

Assignable pedal

Connect either a footswitch or an expression pedal to the ASSIGNABLE connector on the back panel. Use an (optional) Korg PS1 or PS3 footswitch pedal, a Korg EXP-2 expression pedal, a Korg XVP-10 volume pedal, or a compatible one. To calibrate the pedal, go to the Controllers > Foot Controller page of the Global mode.

The music stand

A music stand comes standard with your Pa900. Insert its legs into the two dedicated holes on the rear panel, as shown in the illustration:

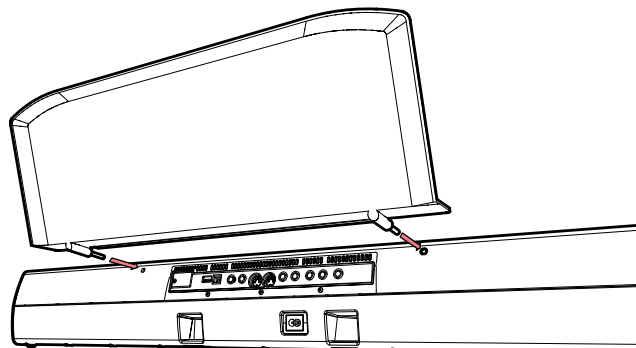

Glossary of Terms

Before you begin, take a few moments to familiarize yourself with the names and terms we will be using to talk about the various elements of the Pa900.

In this section, you will find a brief description of various key elements of the Pa900. A professional arranger (Pa) keyboard uses different terminology than a traditional synthesizer or workstation. By familiarizing yourself with the names and functions in this section, you will get a better understanding of how all the different parts of the Pa900 work together to create a realistic musical performance. This will also help you to get the most out of the rest of the manual.

Sound

A Sound is the most basic unit of an Arranger Keyboard performance. A Sound is basically a playable instrument timbre (piano, bass, sax, guitar...) that can be edited, saved, recalled and assigned to any track. An individual Sound can be played on the keyboard in the Sound mode. In the Style Play, Song Play or Sequencer mode, Sounds may be freely assigned to Sequencer tracks, Style tracks, or Keyboard tracks.

Style

The Style is the heart of a professional arranger keyboard. At its basic level, a Style will consist of up to eight parts, or "Tracks".

Drums

The Drum track will provide a repeating rhythmic phrase, played by the standard instruments of a Drum Kit.

Percussion

An additional rhythmic phrase played by various percussion instruments (conga, shaker, cowbell, etc.) is provided by the Percussion track.

Bass & Accompaniment

The Bass track and the (up to) five additional Accompaniment tracks will each play musical phrases that are musically related to and in sync with the Drum and Percussion tracks. However, the notes being played by these tracks *will* change to follow the chord progression that you play on the keyboard.

Again, any Sound you choose may be assigned to any track in a Style.

Variation

For each Style, there are four Variations, to be used for the Verse, Bridge and Chorus of a song. In general, each Variation is a slightly different version of the others. As you progress from Variation one to Variation four, the arrangements will become more complex, and more parts (Tracks) may be added. This allows your performance to have a more dynamic arrangement, without losing the original "feel" of the Style.

Fill-in & Break

During a performance, a drummer may often perform a "fill" - such as when transitioning from a verse to a chorus - adding extra dynamics and keeping the beat from getting too repetitive. The Pa900 offers four Fill-ins specifically programmed for each Style, that may be automatically recalled when choosing the corresponding Variation (Auto Fill). A Fill-in may be drums alone or drums with instrumentation. Then, there is even a silent "break".

Intro & Ending

Each Style also allows you to complete your performance with a set of musical introductions and endings. A long and short version of the Intro and Ending are usually provided, with the former more harmonically elaborated, and the latter with a fixed chord. A "count-in" Style Intro is also provided, as well as the quick Ending 3.

Pad

Pads are single sounds or single-track patterns, that can be triggered by using the dedicated PAD buttons. They can be used to play in realtime single sounds, as well as short, cycling sequences that play in time with the Style or Standard MIDI File, and are transposed according to the recognized chords.

Keyboard tracks

In addition to the Style and Pad tracks, up to four additional parts can be played on the keyboard in real-time. Each of these Keyboard tracks can be limited to a particular range of keys or velocities, but in general up to three can be assigned to play above the split point (Upper), and one below (Lower). This allows the Upper Sounds to be layered together. The split point can be set to any note on the keyboard. In addition to performing along with a Style, these same Keyboard tracks will allow you to play along with the Players.

STS (Single Touch Settings)

Single Touch Settings allow you to instantly change the sounds assigned to each of the Keyboard tracks with a single button press, allowing for wide variation in sounds during a perfor-

mance. Four STS (Single Touch Settings) can be saved with each Style or SongBook Entry.

Ensemble

By turning the Ensemble feature on, a single note played on one of the Keyboard tracks will be embellished by additional notes to create a complete chord voicing. The Ensemble knows which notes to add by looking at the chord that you are playing. In addition, the Ensemble parameters allow you to select the type of voicing that will be added – from a simple one-note harmony to a full “Brass” section – even a marimba-style trill!

Performance

The Performance is the most encompassing setting on the Pa900 – a single setting that can remember a Style (with all the appropriate sounds), the Keyboard tracks (with all the appropriate sounds) and all their Tempo, transposition, effects, etc... A Performance can be stored in one of the Performance bank locations, or it can be saved in a “database” format using the SongBook function.

Sequencer

The Sequencer acts as a recorder, so you can capture and playback your performances. The Pa900 sequencer can function in different modes. In the Backing Sequence mode, each Style element and each Keyboard and Pads element can be recorded on a separate track in a single pass. This can be a big help in getting a song recorded quickly. The sequencer can also behave as a traditional 16-track linear sequencer, where each track is recorded individually one at a time.

Player

The Player lets you playback your performances or any Standard MIDI File or MP3 file.

The LOGO decoder

On the front panel of your Pa900 you have probably noticed a series of logos, and may have even wondered what they stand for. Well, here is a quick explanation of each one.



General MIDI (GM) is a standard that ensures the compatibility of sounds and messages between GM compatible instruments available from different manufacturers. For example, sequenced songs created on any GM equipped product and saved in the GM format will playback correctly on the Pa900.

General MIDI 2 extends the basic features of the General MIDI, allowing for 256 Sounds and 9 Drum Kits (instead of 128 and 1).



RX Technology is the cutting edge engine that drives every aspect of the Pa900 – from the synthesis to the display and how it all works together.



DNC (Defined Nuance Control) is the way of fine-controlling Korg's powerful sound engine. Every nuance and every detail of the sound can be assigned to a different control, be it the keyboard velocity or a physical controller.



TouchView is the sophisticated technology allowing for touching the objects in the display, instead of pointing to them through an external device (a mouse, a series of buttons). Go straight to the musical elements, instead of catching keys somewhere on the control panel.



TC-Helicon is the world's leading company in vocal processing. Korg partnered with them for the outstanding Voice Processor technologies included in our Pa-Series instruments.

Interface basics

Color TouchView graphical user interface

Pa900 features our exclusive easy-to-use TouchView graphic interface, based on a touch-panel LCD screen. By touching items on the LCD screen, you can select pages, tabs, and parameters, and set parameter values via on-screen menus and buttons. Here are the basic elements of the user interface.

Menus and sections

Pages are grouped in sections, to be selected by touching the corresponding buttons in the Edit menu that opens up when you press the MENU button.

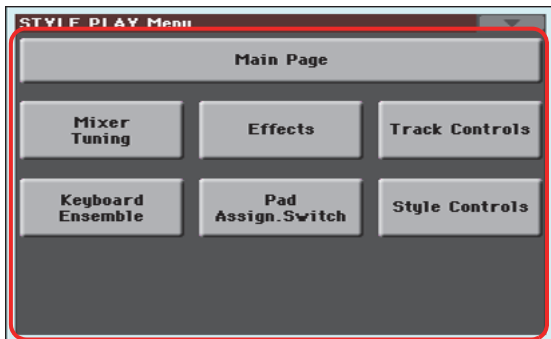

Pages

Parameters are grouped into separate pages, to be selected by touching the corresponding tabs on the lower area of the display.



Overlapping windows

Several windows, like the Style Select or Pad Select, the Global, the Media, or the Lyrics, overlap the current window. After you select an item in the window, or press the EXIT button, the window closes, and the underlying page is shown again. (The following example is the Sound Select window).

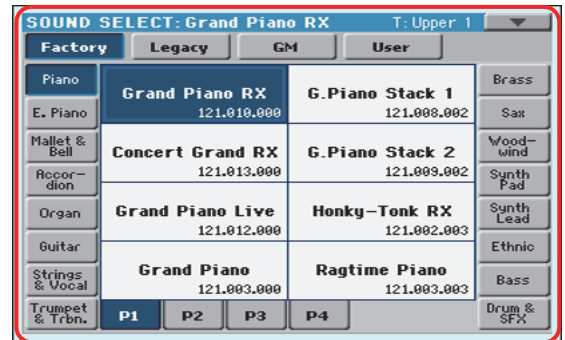

Dialog boxes

Similar to selecting windows, dialog boxes overlap the underlying page. Touch one of the button on the display to give Pa900 an answer, and the dialog box will close.

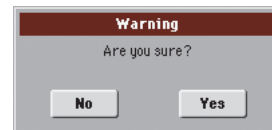

Page menus

Touch the icon on the upper right corner of each page, and a menu with suitable commands for the current page will appear. Touch one of the available commands to select it. (Or, touch anywhere else on the screen to make it disappear, with no command selected).

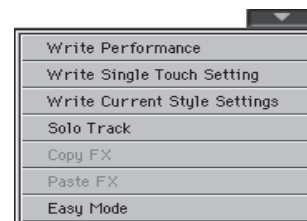

Pop-up menus

When an arrow appears next to a parameter name, touch it to open a pop-up menu. Select any of the available options (or anywhere else on the screen to make the menu disappear).

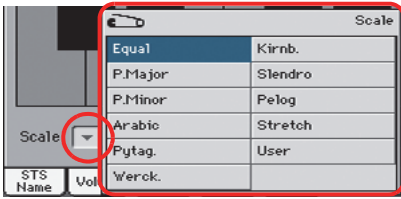

Checkboxes

This kind of parameters are on/off switches. Touch them to change their status.

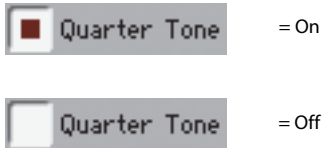

Numeric fields

When a numeric value can be edited, touch it a second time to open the Numeric Keypad.

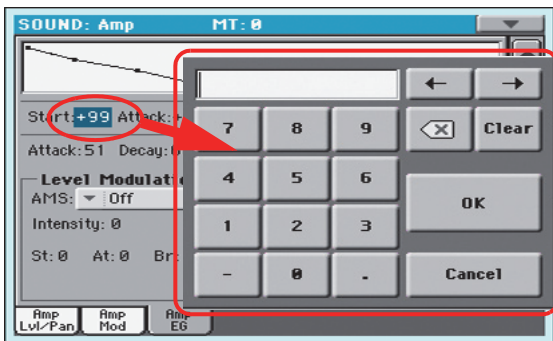

The virtual numeric keypad works exactly as the numeric keypad of a personal computer.

As an alternative, touch a numeric field and keep it held. Then move your fingers up (or right) to increase the value, or move it down (or left) to decrease it.

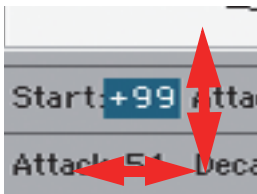

This also includes the Tempo numeric field in the main page of the Style Play, Song Play, and Sequencer modes.

Editable names

When the **T** (Text Edit) button appears next to a name, touch it to open the Text Edit window and edit the name.



The virtual keyboard works exactly as a personal computer's keyboard. Some of the symbols are context-sensitive, and only appear when they can actually be used.

Lists and scrollbars

Files on storage media, as well as other kinds of data, are shown as lists. Use the scrollbar to scroll the list content. Also, you can use the VALUE DIAL to scroll.



List

Scrollbar

When the Name label is selected, keep the SHIFT button pressed while touching one of the arrows on the scrollbar, to scroll to the next or previous alphabetic section.

Virtual sliders

To change a virtual slider's position, select it, then use the VALUE dial to change its position. As an alternative, touch a slider with your fingers and keep it held; then move it up or down to change its position.

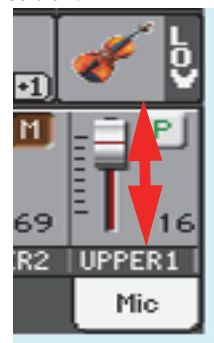

Virtual knobs

To change a virtual knob's position, select it, then use the VALUE dial to change its position. As an alternative, touch a knob with your finger and keep it held; then move your fingers up (or right) to rotate it clockwise, or move it down (or left) to rotate the knob counter-clockwise.



Virtual drawbars

To change a virtual drawbar's position, touch it with your fingers and keep it held. Then move it up or down to change its position.

As an alternative, select it, then use the VALUE DIAL to change its position.

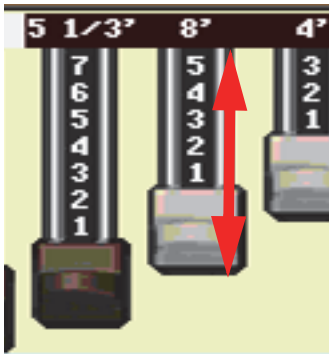

Icons

Various icons help identifying the type of a file, a Song, a folder. For example:



Folder



File of Style bank



Standard MIDI File

Operative modes

The pages of Pa900 are grouped in various operating modes. Each mode is accessed by pressing the corresponding button in the MODE section on the control panel.

Each operating mode is marked with a different *color code*, that helps you understand at first sight where you are.

Two special modes (Global and Media) overlap the current operating mode, that remains active in the background.

The Record mode can be accessed from the Style Play and Sequencer modes, and allows for creating new Styles or Songs. It can also be accessed from the Sound mode, where allows you to edit Samples.

Selected, highlighted items

Any operation on parameters, data or list entries, is executed on highlighted items. First select the parameter or item, then execute the operation.



Non-available, grayed-out parameters

When a parameter or command is not currently available, it is shown in grey on the display. This means it cannot be selected, but may become available when a different option is selected, or you switch to a different page.



Shortcuts

Some commands or pages can be recalled by keeping the SHIFT button pressed, and pressing other buttons or elements in the display. See the "Shortcuts" chapter on page "Shortcuts" on page 437 for a list of available shortcuts.

Easy Mode

If you have never used an arranger before, we suggest you to switch to the Easy Mode. Easy Mode allows you to play Styles and Songs with a simple user interface, free from the many advanced parameters that you will want to learn at a later date.

Turning the Easy Mode on

Touch the little rectangle on the top right corner of the display, to open the *page menu*:

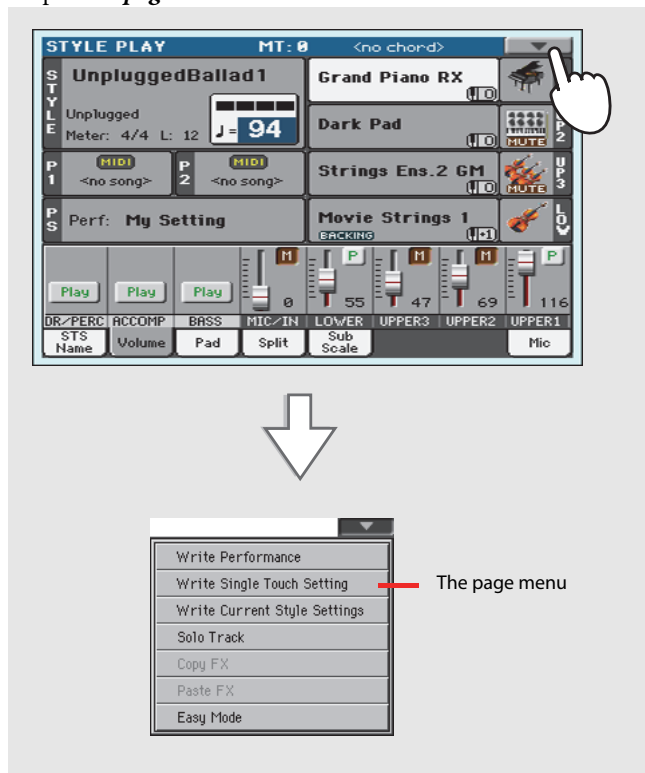

Touch the “Easy Mode” menu item, to make the checkmark appear:

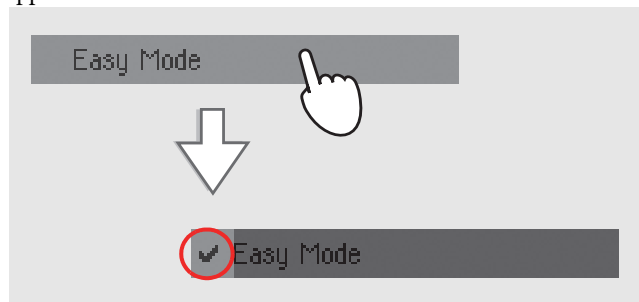

At this point, the Easy Mode has been activated, and the elements in the display appear less crowded:



Turning the Easy Mode off

Reverse the above operation when you want to deactivate the Easy Mode.

The Style Play page in detail

To see this page, press the STYLE PLAY button.

The screenshot shows the 'STYLE PLAY' interface with the following elements and annotations:

- Style name and info:** 'UnpluggedBallad1', Bank: Unplugged, Meter: 4/4. Annotation: 'Style name and info. Touch the Style's name to open the Style Select window and choose a different Style.'
- Tempo:** 'L: 12', 'J = 94'. Annotation: 'Tempo. Use the TEMPO buttons to change it.'
- Accompaniment pattern:** 'Chord: <no chord>'. Annotation: 'Length of the accompaniment pattern, and current beat.'
- Performance or STS:** 'Perf: My Setting'. Annotation: 'Performance or STS. Touch it to open the Performance Select window and choose a different Performance. Sounds on the keyboard will change.'
- Voice Processor Preset:** 'TC-Helicon'. Annotation: 'Voice Processor Preset. Touch here to choose a different Preset.'
- Single Touch Settings (STS):** STS 1 (Nylon Guitar), STS 2 (Distortion Gtr), STS 3 (Trumpet & Muted), STS 4 (Electric Piano). Annotation: 'Single Touch Settings (STS). Touch one of them to choose it, or use the dedicated buttons on the control panel. Sounds on the keyboard will change.'
- Sounds assigned to the right hand (UP1 to UP3) and to the left hand (LOW):** Grand Piano RX, Dark Pad, Strings Ens.2 GM, Movie Strings 1. Annotations: 'Sounds assigned to the right hand (UP1 to UP3) and to the left hand (LOW). Touch the Sound's name to open the Sound Select window and choose a different Sound.'
- Sound icon and status:** 'MUTE' icons are shown next to Grand Piano RX, Dark Pad, and Strings Ens.2 GM. Annotation: 'Sound icon and status. If the MUTE icon appears, the Sound is in mute and cannot be heard. If the icon does not appear, the Sound is in play and can be heard. See page 39'
- Split Point:** 'C4'. Annotation: 'Split Point. Touch here and play a note to set the new split point. See page 43'
- Mic Talk:** 'Mic Talk' button. Annotation: 'Mic Talk. Touch here to lower the background music and talk to your audience.'

Notes:

- There are three Sounds for the right hand (Upper 1, Upper 2, Upper 3), and a single Sound for the left hand (Lower). Their names are abbreviated as UP1, UP2, UP3, LOW, and are shown on the right side of the display.
- Right hand (Upper) and left hand (Lower) Sounds are separated by the Split Point.
- Performances and STSs are collections of Sounds. Just choose one of them to change all the keyboard's Sounds.
- Choose a Style to change the musical style of the accompaniment patterns.

The Song Play page in detail

To see this page, press the SONG PLAY button.

The screenshot shows the SONG PLAY control panel with the following elements and annotations:

- Tempo:** MT: 0
- Player 1 (UP1):** LoveSong (MIDI), Meter: 1/4, M:---, J=240
- Player 2 (UP2):** <no song> (MIDI), Meter: 4/4, M:---, J=120
- Performance (P):** Perf: My Setting
- Voice Processor Preset (V):** TC-Helicon
- Sounds:** Grand Piano RX, Dark Pad, Strings Ens.2 GM, Movie Strings 1, Nylon Guitar (STS 1), Distortion Gtr (STS 2), Trumpet & Muted (STS 3), Electric Piano (STS 4)
- Buttons:** Mic Talk, Split point (C4)
- Annotations:**
 - Red lines point from text boxes to specific elements on the screen.
 - Red circles highlight the MIDI icons, the J=240 and J=120 tempo indicators, the MUTE icons, and the STS buttons.

Text annotations on the left side:

- Song assigned to Player 1. Touch it to open the Song Select window and choose a different Song.
- Tempo. Use the TEMPO buttons to change it.
- Meter (or Time Signature) and current beat.
- Song assigned to Player 2. Touch it to open the Song Select window and choose a different Song.
- Performance or STS. Touch it to open the Performance Select window and choose a different Performance. Sounds on the keyboard will change.
- Voice Processor Preset. Touch here to choose a different Preset.

Text annotations on the right side:

- Sounds assigned to the right hand (UP1 to UP3) and to the left hand (LOW). Touch the Sound's name to open the Sound Select window and choose a different Sound.
- Sound icon and status. If the **MUTE** icon appears, the Sound is in mute and cannot be heard. If the icon does not appear, the Sound is in play and can be heard. See page 39
- Split Point. Touch here and play a note to set the new split point. See page 43
- Mic Talk. Touch here to lower the background music and talk to your audience.

Text annotation at the bottom:

- Single Touch Settings (STS). Touch one of them to choose it, or use the dedicated buttons on the control panel. Sounds on the keyboard will change.

Notes:

- As in Style Play mode, there are three Sounds for the right hand (Upper 1, Upper 2, Upper 3), and one Sound for the left hand (Lower). Their names are abbreviated as UP1, UP2, UP3, LOW, and are shown in the right side of the display.
- Right hand (Upper) and left hand (Lower) Sounds are separated by the Split Point.
- Performances and STSs are collections of Sounds. Just choose one of them to change all the keyboard's Sounds.
- Available STSs depend on the Style or SongBook Entry you last selected.
- Since there are two onboard Players, you can play two Songs at the same time. Mix them using the X-Fader on the control panel.
- Touching a Song name in the display is the same as to press one of the SELECT buttons on the control panel. Each Player has its own SELECT and transport buttons.

Quick Guide

Turning the instrument on

First of all, turn the instrument on and familiarize with the main screen. You can also listen to the demos.

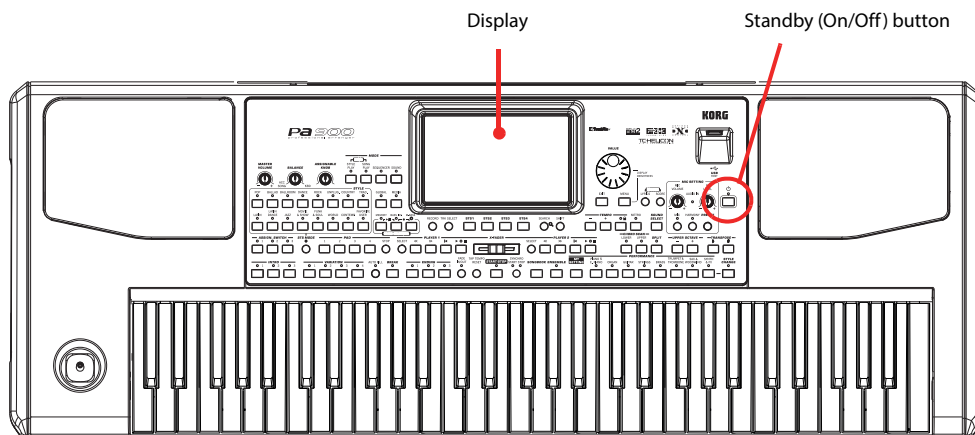

Turning the instrument on and viewing the main screen

- 1 Turn Pa900 on (exit from standby) by pressing the **STANDBY** button located in the control panel.

After you turn the instrument on, a welcome screen is shown for some seconds, then the main display appears.

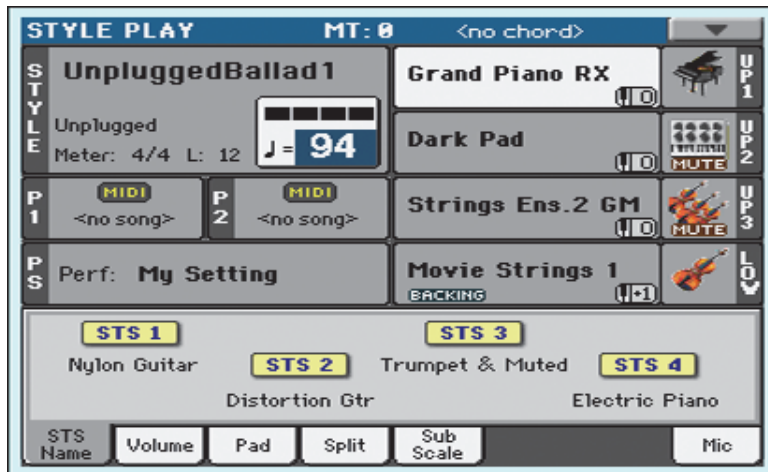

- 2 When you want to put Pa900 to standby, keep the **STANDBY** button pressed for about one second, and release it when the screen appears dimmed.

After having pressed the **STANDBY** button, the display brightness will be dimmed. At this point, the shutdown procedure will begin and last for a few seconds. Please do not disconnect the power cable during this procedure.

Connecting and calibrating the Damper pedal

If you want to play Piano, you will want to connect a Damper pedal to sustain notes while playing. You can connect a Korg PS1, PS3 or DS1H to the DAMPER connector on the back of the instrument.

The difference between the PS1/PS3 footswitch, and a dedicated Damper pedal like the DS1H, is that this latter also supports all the nuances of half-peddalling; you can experiment how it works by gradually pressing it down, and gradually depressing it up while playing the Grand Piano RX Sound.

Damper and Assignable pedal connectors

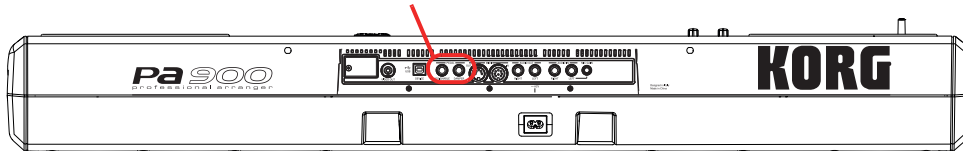

Programming the Damper pedal

Calibrating the Damper pedal will let you use the full run of the pedal, without “dead spots”. Also, this might be the only way to connect a third-party Damper pedal that seems to work in reverse, sustaining the notes when they are not pressed!

- 1 **Connect the Damper pedal to the DAMPER connector on the back of the instrument.**
- 2 **Press the GLOBAL button to access the Global mode.**

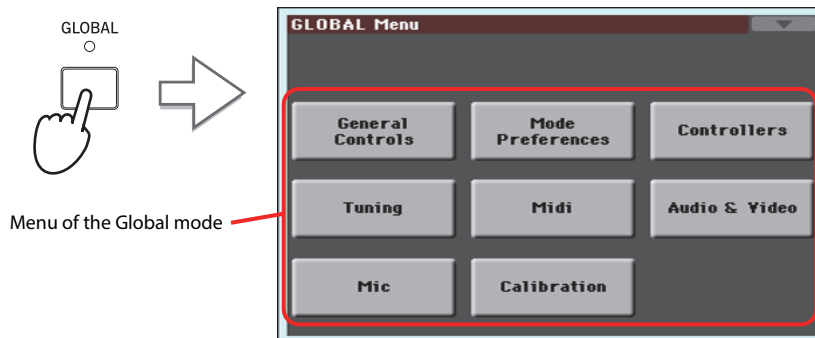

Global mode is where you can set some global parameters, like this one, the Master Tuning or the Date & Time. These settings are not tied to any specific operative mode, so they are programmed in these separate pages.

- 3 **Touch the Controllers button to access the Controllers section of the Global mode.**

If you have not yet chosen a different page, the “Hand Controller” page will appear (being the first one in the Controllers section).



4 Touch the Foot Contr. tab to select the "Foot Controllers" page.

This is the page where you can program the Assignable Pedal/Footswitch and the Damper pedals.

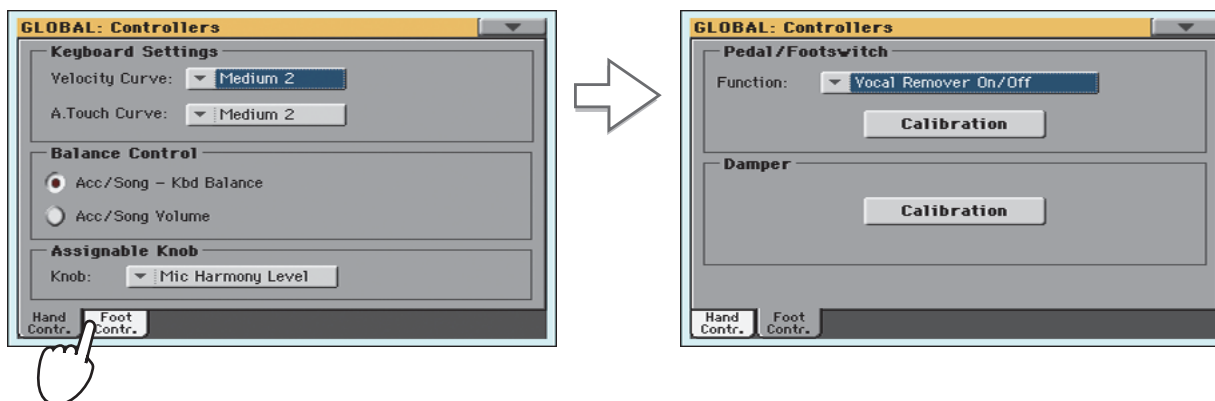

5 Touch the "Calibration" button in the Damper section, to make the "Damper & Pedal/Footswitch Calibration" dialog box appear.

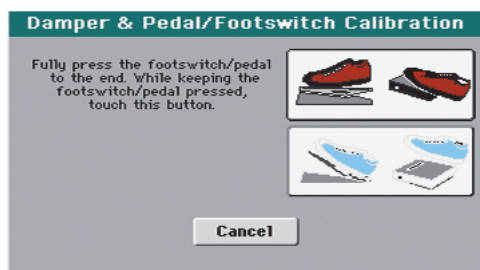

6 Fully press the Damper pedal down, and while continuing to press touch the "Push" button to confirm the maximum value.

7 When the following dialog box appears, release the pedal.

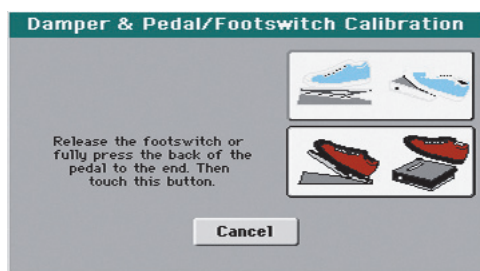

8 Touch the "Push" button in the display to confirm the minimum value.

Check if the pedal is working properly. In case it isn't, repeat the procedure.

9 Press the EXIT button to return to the previous operative mode.

Playing the Demo

Listen to the built-in Demo Songs to appreciate the power of Pa900. There are several Demo Songs to choose from.

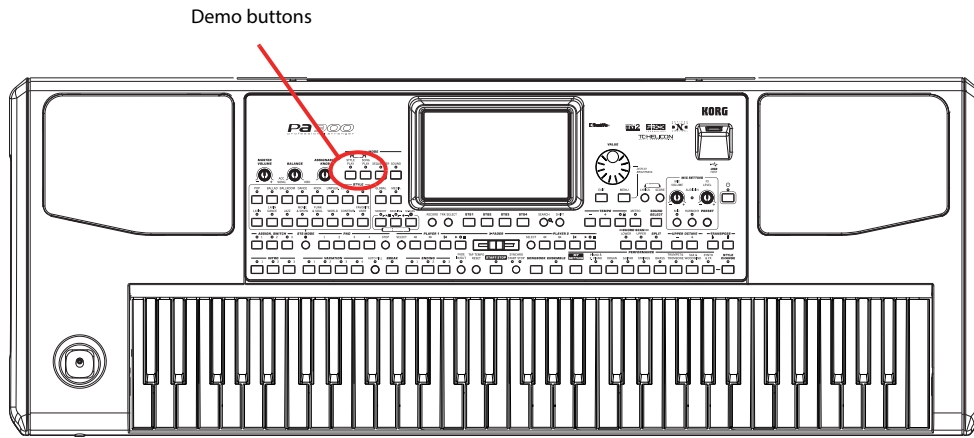

Starting and stopping the Demo

Here is how to start, choose and stop the Demo Songs.

- 1 Press the **STYLE PLAY** and **SONG PLAY** buttons together.

The LED of the two buttons will start blinking. Pa900 will be set in Demo mode.



At this point, if no other button is pressed, all the Demo Songs will be played back.

- 2 In case you want to listen to a specified Demo Song, select one of the available options on the display (**Full Songs**, **Solo Instruments**, **Styles**).

- 3** Choose one of the Demo. To stop it, touch the **STOP** button on the display.

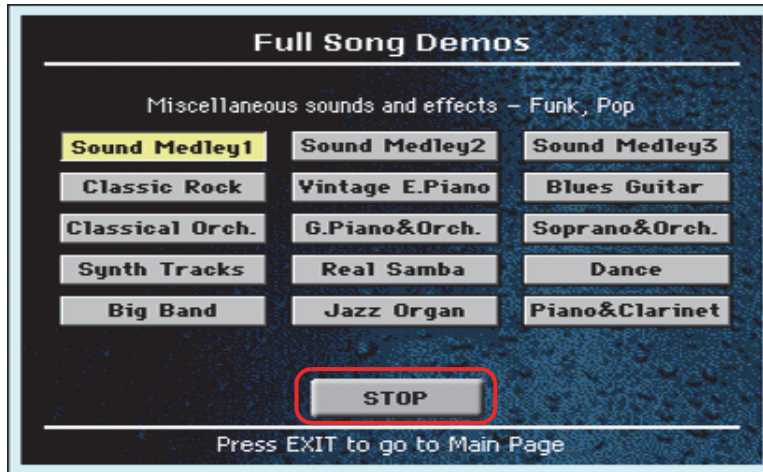

- 4** Exit from the Demo mode by pressing any one of the **MODE** buttons.

Playing Sounds

You can play up to three sounds at the same time on the keyboard. You can also split the keyboard in two parts, to play up to three sounds with your right hand (Upper) and one with your left hand (Lower).

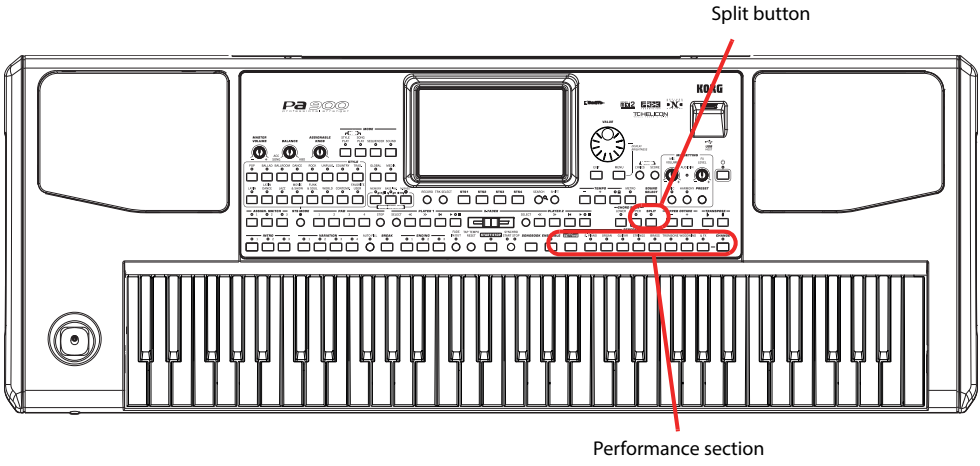

Selecting a Sound and playing it on the keyboard

1 Be sure the Upper 1 track is selected and set to play.

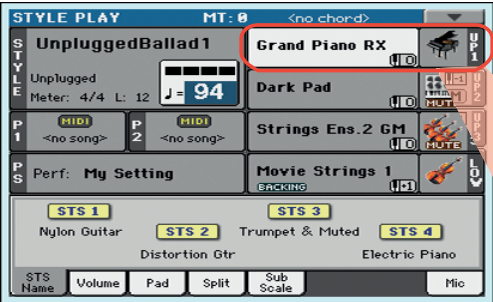

A selected track is shown with a white background. In this example, the Upper 1 track is selected. **If it is not selected, touch it once to select it.**

The fact that there isn't a **MUTE** icon over the bank icon means that the Upper 1 track is set to play. **If it is muted, touch the bank icon to set it to play.**

i Note: Be sure tracks Upper 2 and Upper 3 are muted and are not playing. If you hear more than one sound, see also page 39 for how to mute tracks.

2 If you want to play the Sound on the whole keyboard, be sure the keyboard is in Full Upper mode (i.e., the SPLIT LED is turned off). If it is split in two parts, press the SPLIT button to turn its LED off.

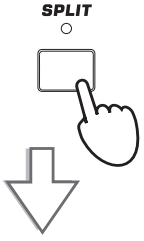

3 Touch the Upper 1 track's area in the display to open the Sound Select window.

Sound's name

Sound bank icon

The selected Sound is highlighted. Touch a Sound's name to select it.

Touch one of the side tabs to select a different Sound bank.

Touch one of the lower tabs to select a different Sound page.

Type of Sounds.

The currently selected Sound appears in the page header.

Target track for the selected Sound

A Previous and Next Page pair of button may appear in this area, when more than six pages are available. As an alternative, repeatedly press the SOUND button to cycle between the pages.

i Note: You can also open the Sound Select window by first touching the track to which to assign the new Sound, then pressing the SOUND SELECT

4 Select a Sound from the Sound Select window, then press the EXIT button to close the window.

EXIT

The Sound Select window closes, and the main screen appears again, with the selected Sound assigned to the Upper 1 track.

5 Play the Sound on the keyboard.

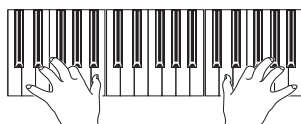

i Note: Selection windows may automatically close after a selection. To do this, uncheck the "Display Hold" box in the Global > General Controls > Interface page. In this case, press the EXIT button only if you don't make any selection but want to close the window.

Playing two or three Sounds at the same time

You can layer all three Upper tracks and play them on the keyboard.



Please note how the **MUTE** icon appears in the Upper 2 and Upper 3 status boxes. These tracks will not be heard.

- 1 Touch the **MUTE** icon in the Upper 2 status box, to set the Upper 2 track to play.



After touching in this area, the **MUTE** icon disappears. The Upper 2 track will be set to play and will be heard.

- 2 Play the keyboard.

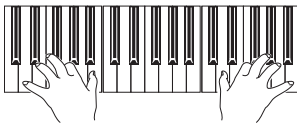

Note how the 'Dark Pad' Sound (assigned to the Upper 2 track) has been layered with the 'Grand Piano RX' (assigned to the Upper 1 track).

- 3 Touch the **MUTE** icon in the Upper 3 status box, to set the Upper 3 track to play.

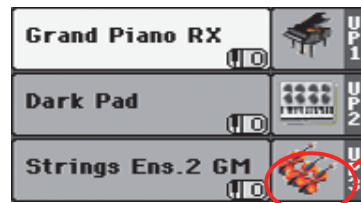
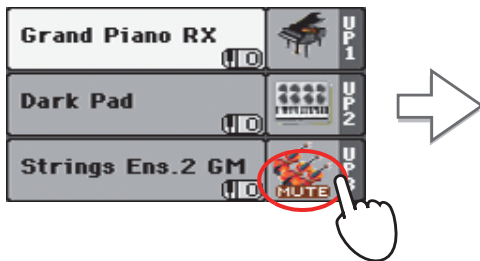

As above, after touching in this area, the **MUTE** icon disappears. The Upper 3 track will be set to play and will be heard.

- 4 Play the keyboard.

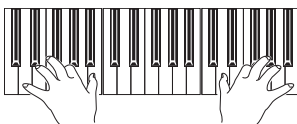

Note how the 'Strings Ens.2 GM' Sound (assigned to the Upper 3 track) has been added to the 'Dark Pad' (assigned to the Upper 2 track) and the 'Grand Piano RX' (assigned to the Upper 1 track).

- 5 Touch the bank icon in the Upper 3 status box, to mute the Upper 3 track again.

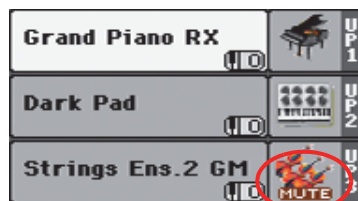
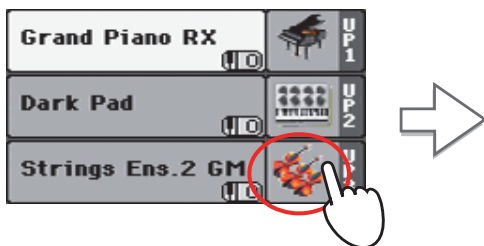

6 Play the keyboard.

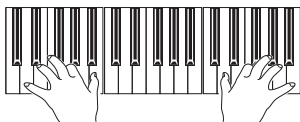

Note how the 'Strings Ens.2 GM' Sound (assigned to the Upper 3 track) has been muted again. Only tracks Upper 1 and Upper 2 can be heard at this time.

7 Touch the bank icon in the Upper 2 status box, to mute the Upper 2 track again.

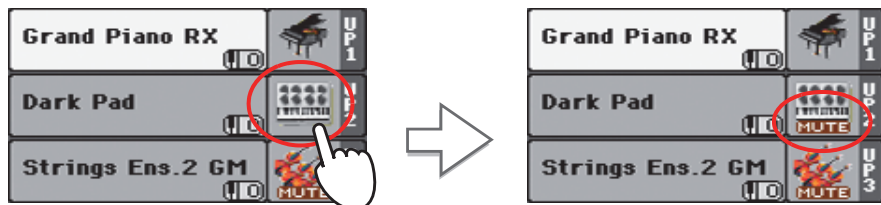

8 Play the keyboard.

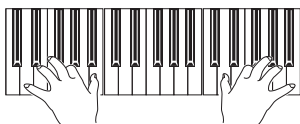

Note how the 'Dark Pad' Sound (assigned to the Upper 2 track) has been muted again. Only track Upper 1 can be heard at this time.

Playing different Sounds with your left and right hand

You can play a single Sound with your left hand, in addition to playing up to three Sounds with your right hand.

- 1 Press the **SPLIT** button to turn its LED on, and split the keyboard in the Lower (left hand) and Upper (right hand) parts.

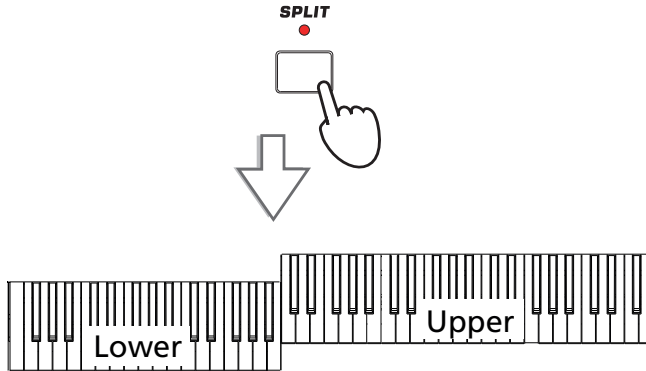

- 2 Be sure the Lower track is set to play.



If the Bass & Lower Backing function is turned on, and the Style is not running, the Lower track will always play.

- 3 Play the keyboard.

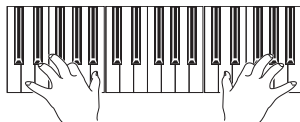

Note how the keyboard is split in two parts, each playing different sounds.

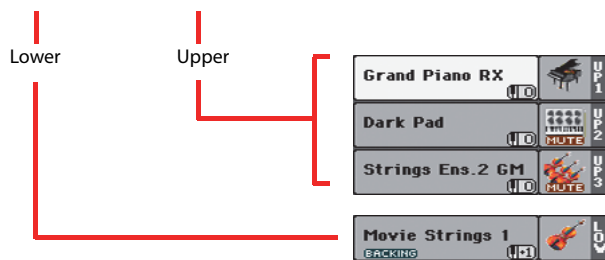

- 4 Return to the full keyboard playing mode by pressing the SPLIT button to turn its LED off.



- 5 Play the keyboard.



Upper

Note how the keyboard once again plays the Upper tracks over the entire length of the keyboard.



Changing the split point

If you are not comfortable with the selected split point, you may set the split point to a different key.

- 1 Touch the Split tab to see the Split Point panel.

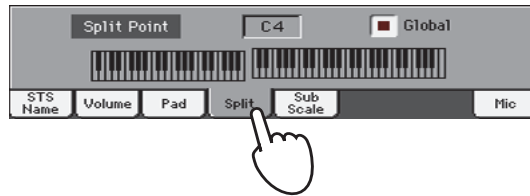

- 2 Touch the keyboard in the display, then play the lowest note of the Upper section on the keyboard.

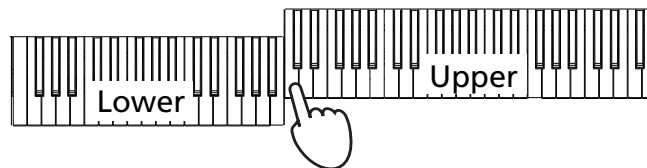
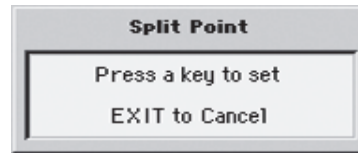
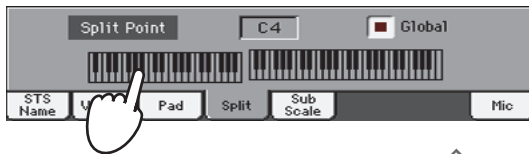

i Hint: As an alternative, keep the SPLIT button pressed to open the Split Point dialog.

- 3 As an alternative, touch the Split Point parameter to select it, and use the VALUE dial to select the new split point.

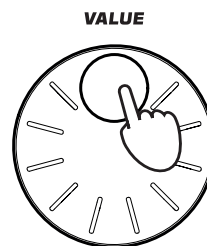
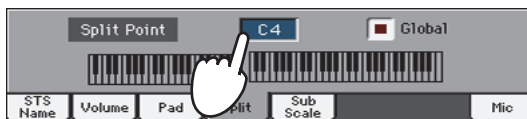

When you change the split point, the “Global” parameter is automatically unchecked. This is because you are setting a “local” or “temporary” split point, and not the “global” one, used across the whole instrument.

To change the “global” split point, go to the Global > Mode Preferences > Style page, and set the “Split Point” parameter.

You can save the “local” split point into a Performance, as described in the following pages (see “Saving your settings to a Performance” on page 46).

Raising or lowering the Upper octave

If all Upper tracks sound too high or too low, you can quickly change which octave they are playing in.

- 1 Use the **UPPER OCTAVE** buttons on the control panel, to transpose all Upper tracks at the same time.

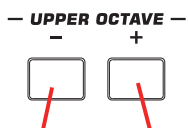

Each time you press this button, the pitch will be lowered by one octave.

Each time you press this button, the pitch will be raised by one octave.

i Note: The Octave Transpose value for each of the keyboard track is shown under the Sound's name.



- 2 Press both **UPPER OCTAVE** buttons together to reset the octave to the value saved in the current Performance.

Selecting and saving Performances

Performances are the musical heart of Pa900. Unlike selecting single Sounds, selecting a Performance will recall several Sounds at the same time, the needed effects and transpositions, plus many more parameters useful for playing in a musical situation (like the Assignable Switches). Performance can be considered a snapshot of the current situation.

You can save these settings to a Performance memory location. While many Performances are already supplied with the instrument, you can customize each of them to your own taste, and then save them in their customized version.

Similar to Performances, but dedicated to the Styles and SongBook Entries, you can also save your settings to a **Single Touch Setting (STS)**, which will store all the settings for the Keyboard tracks. Four STSs are supplied with each Style and SongBook Entry, and can be selected with the four dedicated buttons under the display.

Please note that **settings saved in the "My Setting" Performance are automatically selected when the instrument is turned on (exit from standby).** This means you can save your preferred startup settings to this Performance (see below for more information).

*Note: Style tracks are saved to a third object called the **Style Settings**.*

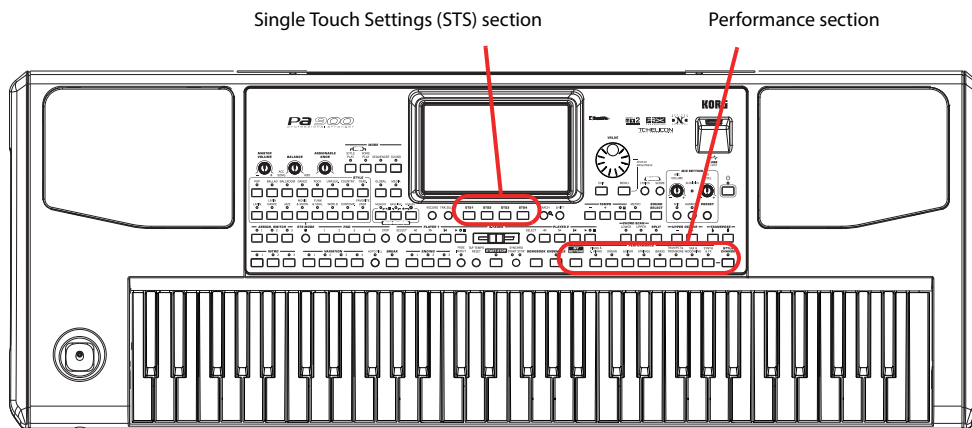

Selecting a Performance

- 1 Touch the Performance area in the display, to open the Performance Select window.

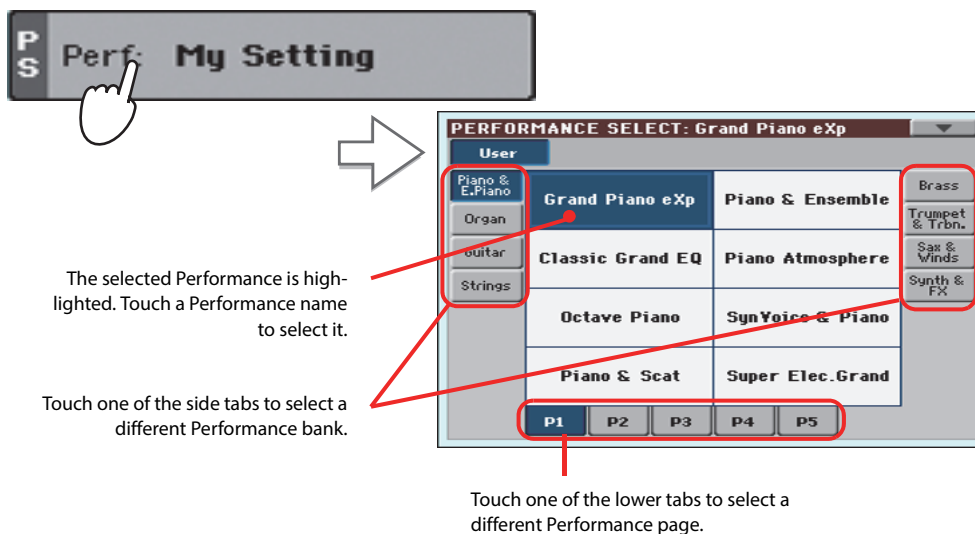

i Hint: You can also open the Performance Select window by pressing one of the buttons in the PERFORMANCE section. This will let you jump directly to the desired Performance bank.

2 Select one of the Performances in the Performance Select window, then press the EXIT button to close the window.

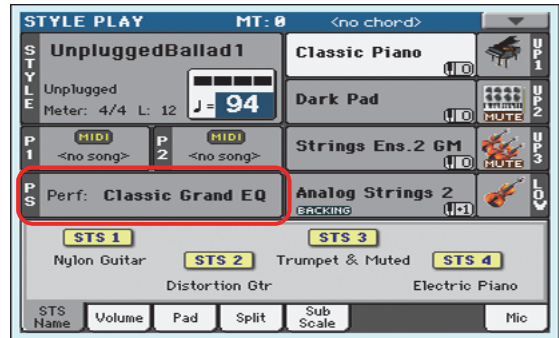
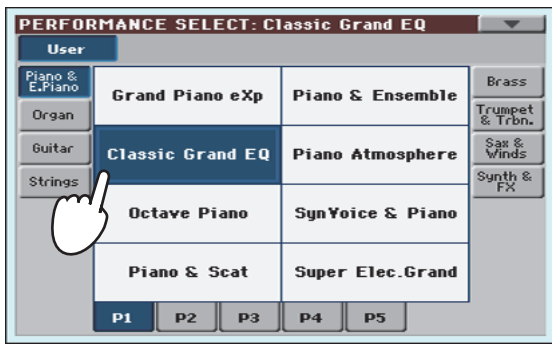

After pressing the EXIT button, the Performance Select window closes, and the main screen appears again. Sounds, Effects, and other settings, change according to the setting memorized in the selected Performance.

Note: Selection windows may automatically close after a selection. To do this, uncheck the “Display Hold” box in the Global > General Controls > Interface page. In this case, press the EXIT button only if you don’t make any selection but want to close the window.

3 Play the keyboard.

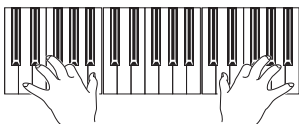

Settings memorized in the selected Performance have been selected. Sounds, effects and other settings have been recalled.

Note: If the **STYLE CHANGE** button is turned on, selecting a Performance may automatically select a different Style and its settings (Sounds, Effects for the Style tracks...)

Saving your settings to a Performance

The Sounds and Effects assigned to the Keyboard tracks, together with the parameters you can access by pressing the MENU button while in Style Play and Song Play mode, can be saved into a single Performance, to be quickly recalled at a later time.

1 Keep one of the PERFORMANCE buttons pressed for about one second to open the Write Performance dialog box.

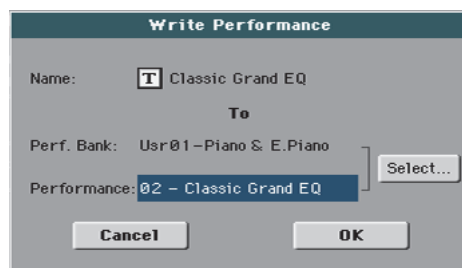
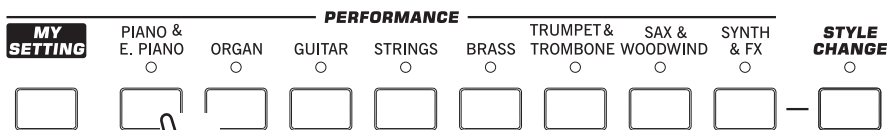

Hint: To open the Write Performance dialog box, you can also choose the ‘Write Performance’ command from the page menu.

2 If you like, you may assign a new name to the Performance.

Use the '<->' and 'DIAL' to move the cursor.

Touch the 'Backspace' symbol to delete just a single character, 'Clear' to delete the whole string.

Use the alphabetic characters to enter text.

Touch the **T** (Text Edit) symbol to open the Text Edit dialog box.

Touch the Shift key to switch between capitals and small characters.

When done, touch OK to confirm the new name, or Cancel to abandon all changes.

3 Select a bank and Performance location in memory, where you would like to save the Performance.

The selected Performance location is highlighted. Touch a Performance's name to select it.

Touch one of the side tabs to select a different Performance bank.

Touch one of the lower tabs to select a different Performance page.

4 When you have edited the name to the Performance, and selected the target location, touch OK to save the Performance to memory (or Cancel to stop the operation).

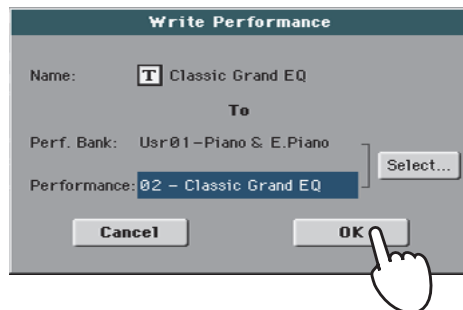

Warning: Saving a Performance to an already used location overwrites any existing data at that location. The old data are lost. Make a backup of all your important data.

Selecting and saving the "My Setting" Performance

There is a special Performance, where you can save your preferred startup settings for things like Keyboard Sounds, Effects, Transposition, Assignable Switches. This Performance is **automatically selected when the instrument is turned on (exit from standby)**. It is called the "My Setting" Performance.

'My Setting' Performance

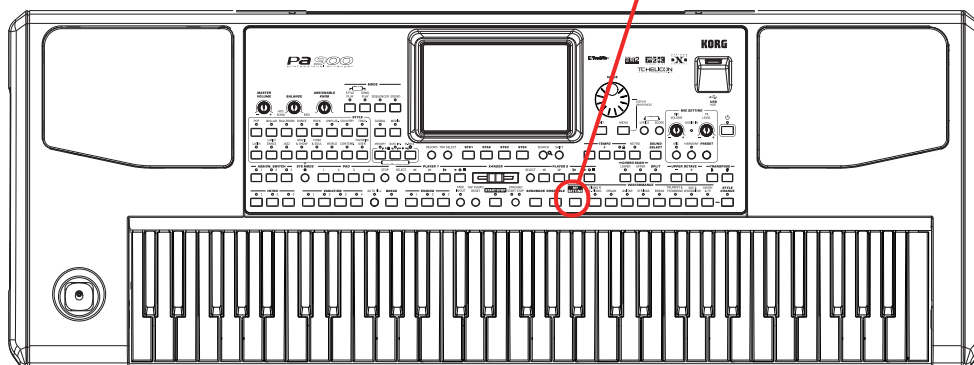

Selecting the startup parameters (the "My Setting" Performance)

After having done some changes to the Sounds, transposition, or other parameters, you can return to the startup situation by pressing the MY SETTING button in the control panel.

- Press the MY SETTING button to recall the "startup" settings.



Saving the startup parameters into the "My Setting" Performance

You can save the startup settings (Sounds and other settings, including most of the settings on the control panel) into this special Performance.

- Keep the MY SETTING button pressed for about one second, until the "Write Startup Settings" dialog box appears, then touch the OK button to confirm saving to memory.

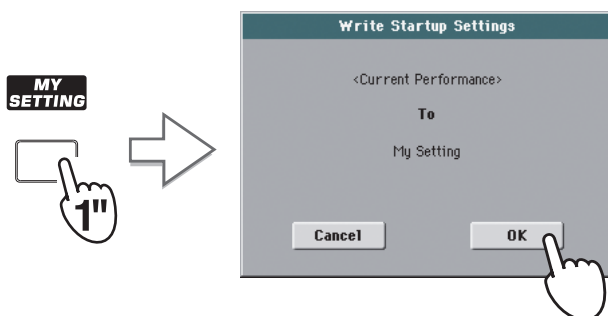

Drawbars

A special type of Sounds in the Pa900 is the Drawbars. This Sound emulates the classic tonewheel organs of the past. You can drag the virtual drawbars on the display to adjust their position, and then save these settings to a Performance, that can be considered the equivalent of an organ's "preset".

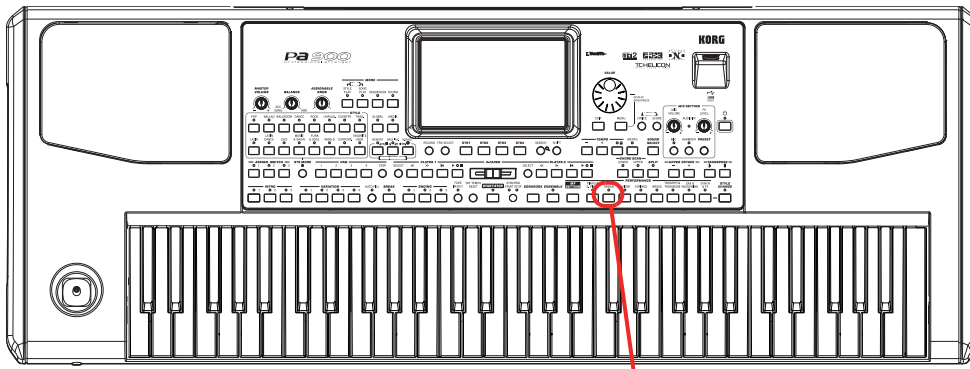

Organ Performance bank

Choosing a Drawbars Preset

Here is how to select and use the Drawbars.

- 1 Press the **ORGAN** button in the **PERFORMANCE** section to open the Performance Select window, and choose the "DWB Organ Y+" Performance.

While you could assign the DRAWBARS Sound to an Upper track, choosing a Performance will also give you all the preset settings for the drawbars.

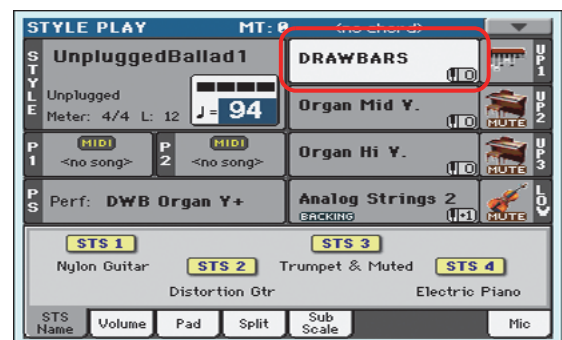
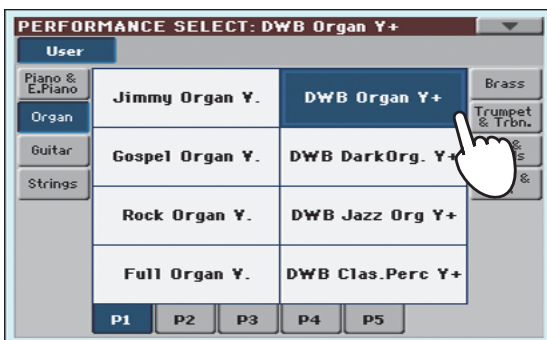
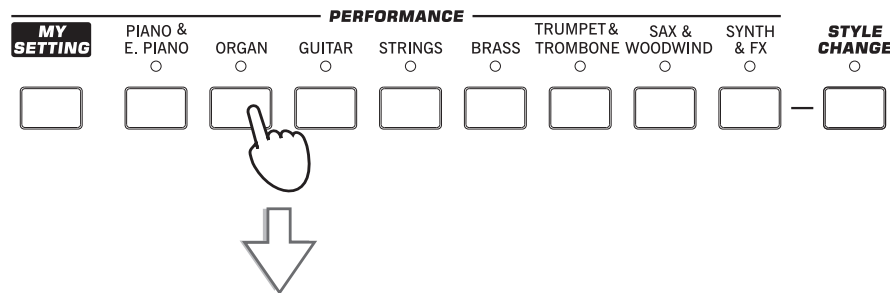

- 2 Play the keyboard to hear a realistic electro-magnetic organ sound.

Different drawbar settings may be stored with each Performance. So, selecting a different Performance will select different settings for the Drawbars Organ.

Editing the Drawbars Preset

You can edit the Drawbars settings memorized in the selected Performance, and save it to the same or a new Performance.

- 1 While in the main screen, touch the **DRAWBARS** Sound to open the **Sound Select** window, then touch the selected **DRAWBARS** Sound to open the **Drawbars Setting** page.

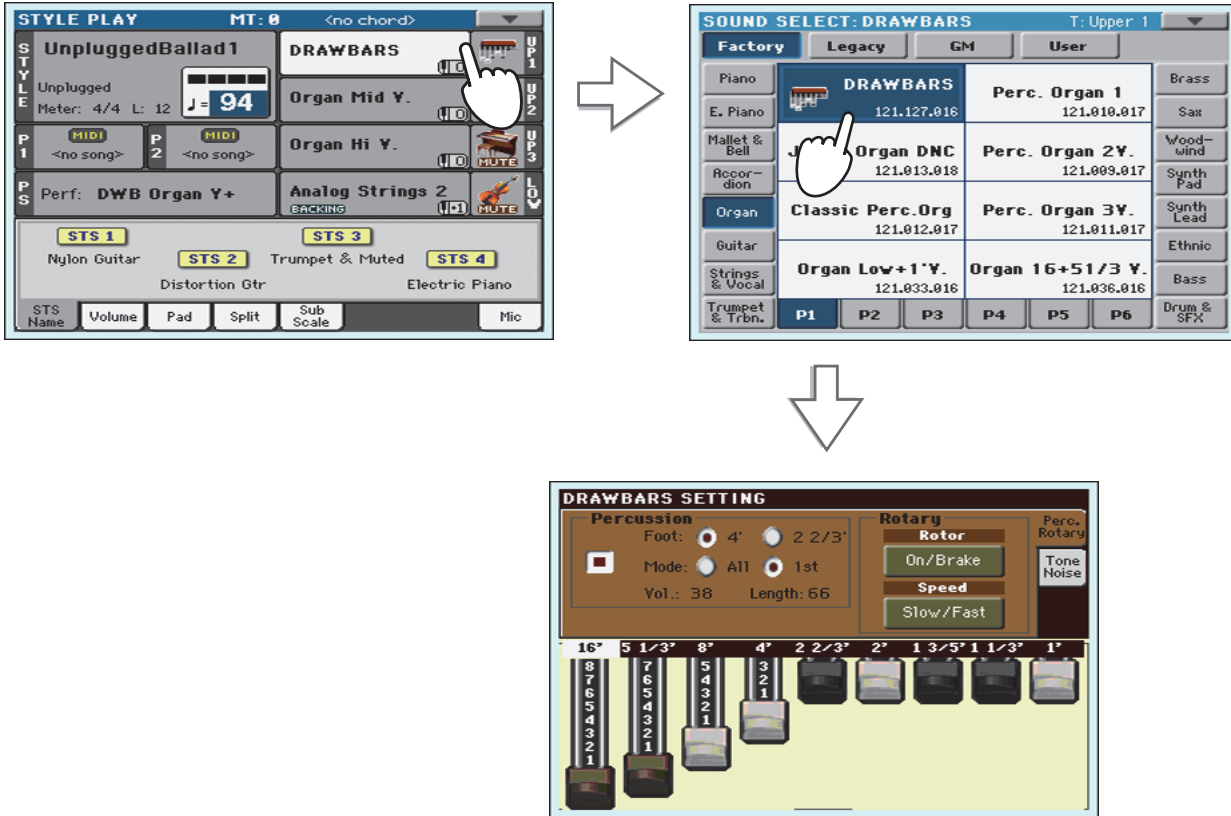

- 2 Drag the virtual sliders to change the various drawbar settings. Select different parameters in this page, and change their settings to see how each setting affects the sound.

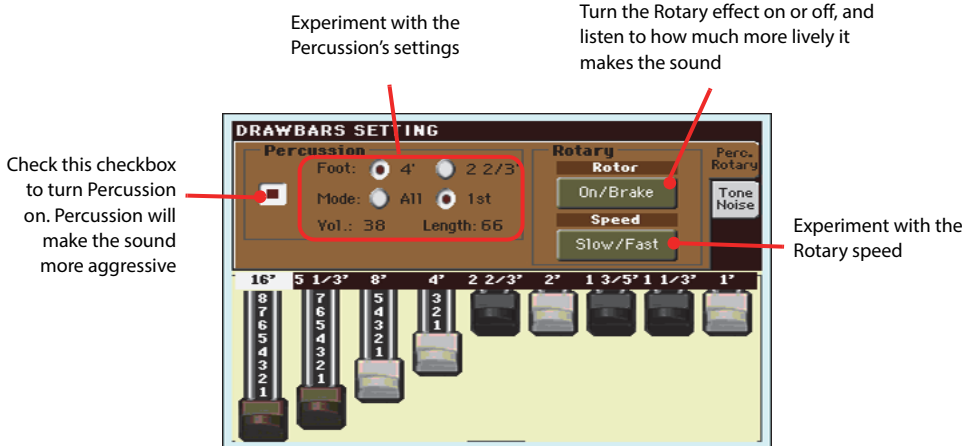

i Hint: As an alternative to dragging the virtual sliders to change drawbar values, you can touch a drawbar in the display and use the **VALUE DIAL** to change it.

- 3 Touch the "Tone/Noise" tab, and try the sound parameters of the second page.

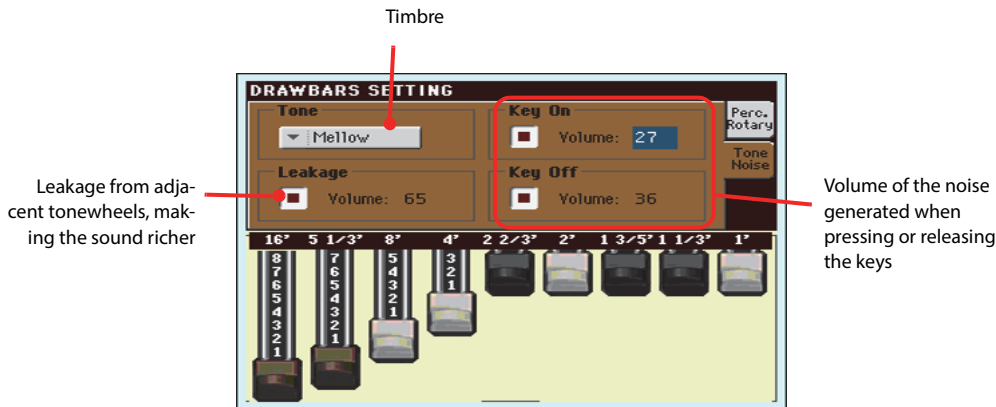

- 4 When you have found some settings that you like, keep one of the ORGAN Performance buttons pressed to open the Write Performance window, and save your settings to a Performance.
- 5 Press the EXIT button to go back to the main page.

Selecting and playing Styles

Pa900 is an *arranger*, i.e. a musical instrument providing automatic accompaniments, or *arrangements*. Each arrangement style is called, as a consequence, a *Style*.

A Style is made of several Style Elements (Intro, Variation, Fill, Break, Ending), corresponding to the various sections of a song. By selecting Style Elements, you can make your playing more varied and musical.

When selecting a Style, Sounds, Effects and various configuration parameters for the Style tracks are also selected. These are called the Style Settings. Selecting a Style also selects the four Pads it contains. Pads are single sounds or single-track patterns, that can be triggered with the dedicated PAD buttons.

If the STS MODE LED is turned on, the first of the four Single Touch Settings (STS) associated to the Style is also selected, and Keyboard tracks, Effects and some other useful parameters are automatically configured.

Use the Style controls to start or stop the Style.

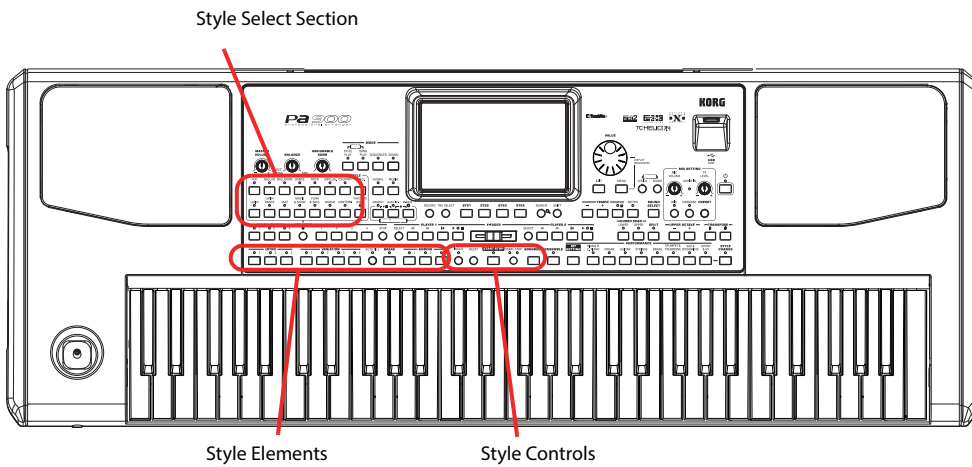

Selecting and playing a Style

1 Touch the Style area in the display. The Style Select window appears.

Type of Style.

The selected Style is highlighted. Touch a Style's name to select it.

Touch one of the side tabs to select a different Style bank.

Touch one of the lower tabs to select a different Style page.

i Hint: You can also open the Style Select window by pressing one of the buttons of the STYLE section. This will let you jump directly to the desired Style bank.

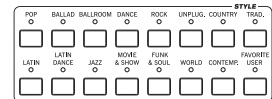

2 Select a Style from the Style Select window.

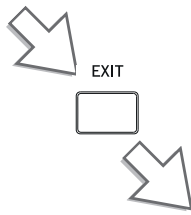

After pressing the EXIT button, the Style Select window closes, and the main screen appears again, with the selected Style ready to go.

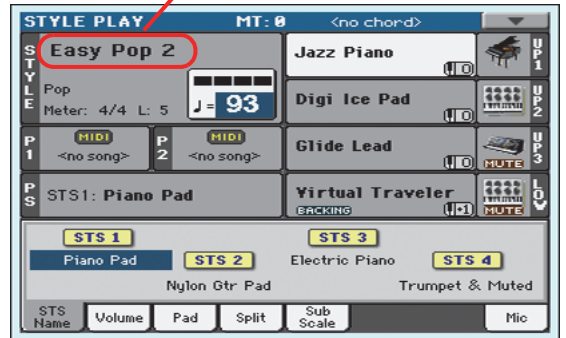

3 Be sure one of the Chord Scan modes is selected.

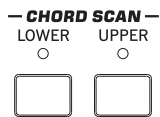

For chord scanning to work, either of both LEDs must be turned on. **Lower:** chords are recognized on the left of the split point; **Upper:** chords are recognized on the right of the split point; **Full (both LEDs on):** chords are recognized on the whole keyboard. **Off:** only the Drum track can be heard.

4 Press the SYNCHRO-START/STOP button to turn the START LED on.

This will turn the Syncho-Start function on, and let the accompaniment start as soon as you play a chord on the keyboard.

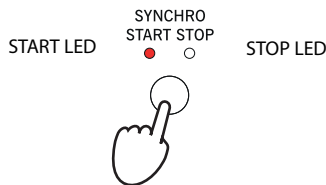

Note: You could simply press START/STOP to start the Style, but the Syncho-Start function allows you to make the Style start in sync with your playing on the keyboard. Therefore, it may be considered a “more musical” way of starting a Style.

5 Play the keyboard.

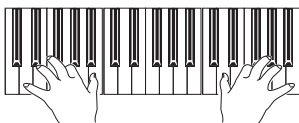

When the Syncho-Start function is turned on, the Style starts playing as soon as you play a note or chord in the chord scan area. Play chords with your left hand, and the melody with your right hand. The arranger will follow your playing.

6 Press START/STOP to stop the Style.



Note: The chord scan area depends on the status of the SPLIT LED and the Chord Recognition parameter (see Global > Mode Preferences > Style).

Tempo

While a Tempo setting is saved with each Style or Performance, you can change it to be whatever you like. You can use either of the following two methods.

- Use the TEMPO + or – buttons to change the Tempo value.

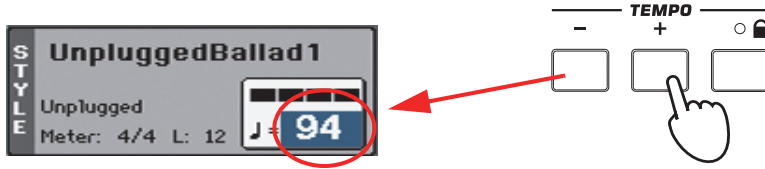

i Hint: As an alternative to using the TEMPO buttons, hold the Tempo value in the display, then move your finger up/down or left/right (or change the value with the VALUE dial).

- Press the TEMPO – and + buttons together to recall the saved Tempo value.

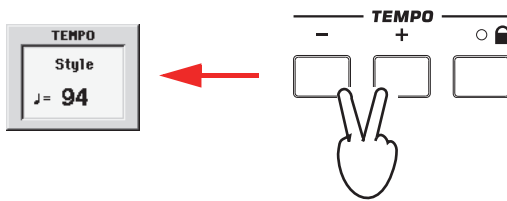

- As an alternative, keep the SHIFT button pressed, and use the VALUE dial to change the Tempo. The selected tempo will be shown in a small window.

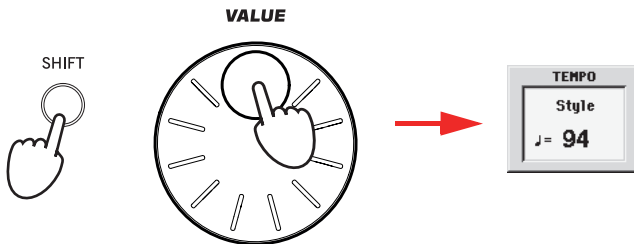

- If you like to keep the currently selected Tempo value unchanged, turn on the LED of the TEMPO  (LOCK) button.

When the Tempo Lock function is turned on, the Tempo will not change when selecting a different Style (or a different Song in Song Play mode).

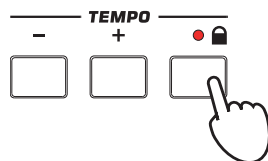

Intro, Variation, Fill, Break, Ending

When playing Styles, you can select various “Style Elements” to cover the various sections of a song. A Style is made of three Intros (or two Intros and a Count-In), up to four basic patterns (Variations), four Fills, a Break, and three Endings.

- 1 **Make sure the SYNCHRO-START LED is turned on (otherwise, press the button to turn it on).**



Activating the Synchro Start function is not mandatory, but it might be handy.

- 2 **Press one of the INTRO buttons to set the corresponding Intro to play.**

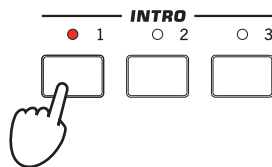

- 3 **Play the keyboard.**

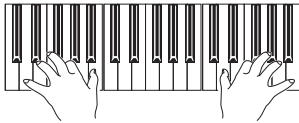

The Style starts with the selected Intro. When the Intro is completed, the basic pattern (selected Variation) starts to play.

- 4 **Be sure the LED of the AUTO FILL button is turned on.**

When the Auto Fill function is turned on, a Fill is automatically performed before switching to a different variation.



- 5 **While playing, press one of the VARIATION buttons, to select a different variation of the basic pattern.**

If you turned the Auto Fill function on in the previous step, a Fill will be performed before the Variation begins.

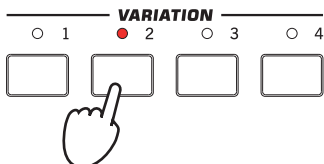

When the Fill ends, the selected Variation will start playing.

- 6** When you like to stop playing, press one of the ENDING buttons to stop the Style with an Ending.

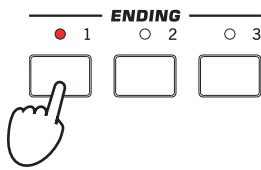

When the Ending is finished, the Style automatically stops.

Single Touch Settings (STS)

Each Style or SongBook Entry may come with up to four Keyboard track settings, called the STS (short for “Single Touch Settings”). STSs are very similar to Performances, but they are fine-tuned to the Style or SongBook Entry they are associated to.

If the STS MODE LED is turned on, STS #1 is automatically selected when choosing a Style. STS #1 is also recalled each time a SongBook Entry is selected.

- 1** In case it is not shown, touch the STS Name tab to see the STS Name panel.

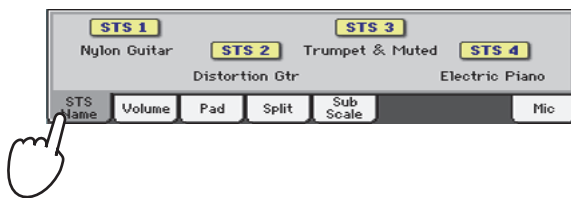

- 2** Press one of the four STS buttons under the display, or touch the name of an STS in the STS panel in the display.

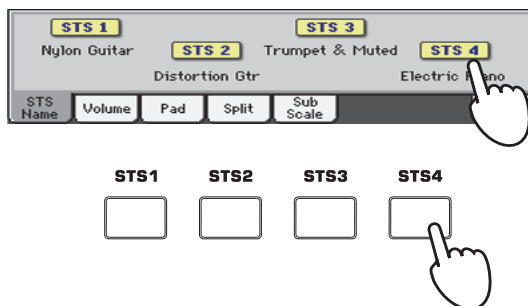

- 3** Play the keyboard.

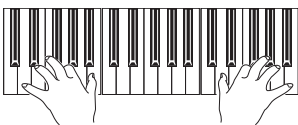

Settings memorized in the selected STS have been selected. Sounds, effects and other settings have been recalled.

- 4** Try all the other STSs, and see how settings change with each of them.

- 5** You can also link the STSs to the Variations. First of all press the STS MODE button, to make its LED flash.



- Then press the various VARIATION buttons, and see how an STS is automatically selected when the corresponding Variation is selected.

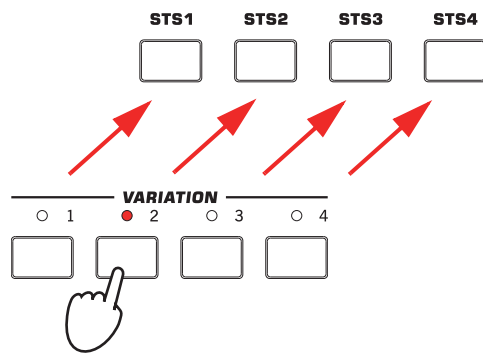

- Press the STS MODE again to turn its LED on (or off).

The Pads

Each Style or SongBook Entry can assign different sounds or patterns to the four PADS. These sounds or patterns can be played along with the Keyboard and Style tracks.

- If you want to see which sounds or patterns are associated to the four Pads for the current Style, touch the Pad tab to see the Pad panel.

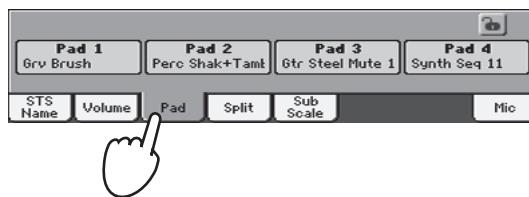

- Press one of the four PADS to play the corresponding Pad.

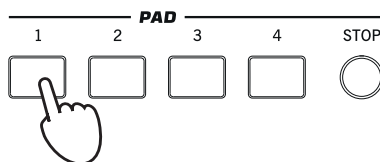

i Hint: You can open the Pad Select window to assign a different sound or pattern to the Pads, by pressing SHIFT + one of the PADS.

- If the selected PAD triggers an endless sound or pattern (i.e. an applause, or a guitar arpeggio), press the same PAD button again to stop it.
- Select a different Style, and see how the sounds or patterns assigned to the PADS change.
- Press more PAD buttons at once, to play two or more sounds or patterns at the same time.
- Press STOP to stop all the Pads at the same time.

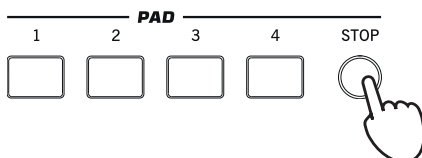

Adjusting the balance between the Style and the keyboard

Balancing between the Keyboard and Style tracks may be useful, to gently fade them and adjust their respective volume.

- While the Style is playing, use the **BALANCE** knob to balance between the Keyboard (KBD) and Style's Accompaniment (ACC) volume.

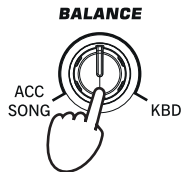

This knob also balances between the Keyboard and the Pad tracks. Also, it balances between the Keyboard and the Song tracks (in Song Play mode).

Adjusting the volume of the separate tracks

You can adjust the volume of each of the Style and Keyboard tracks, for example to soften the bass a little, or to make the keyboard solo louder.

- 1 Touch the Volume tab to see the Volume panel.

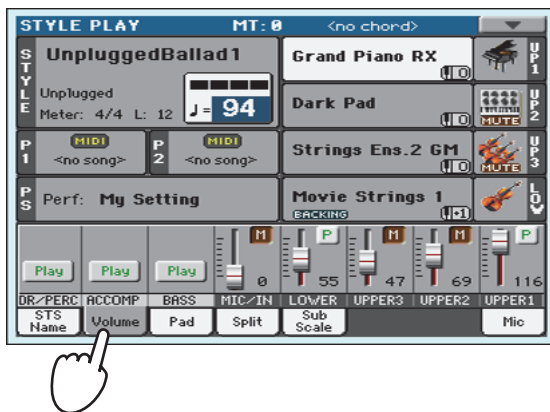

- 2 Hold & drag the Virtual Sliders in the display to adjust each Keyboard track's volume.

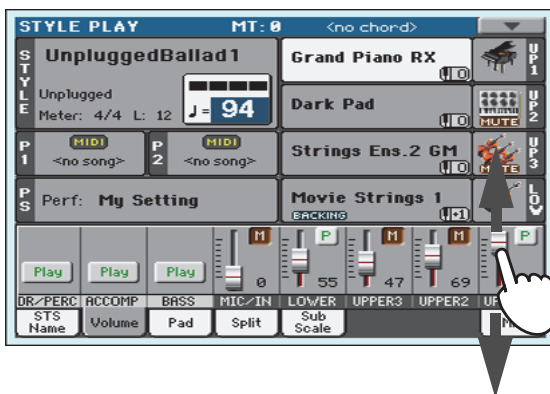

- To separately adjust each Style track, press the TRACK SELECT button to change the track's view.



i Hint: As an alternative, you can change each track's volume, by touching a track's volume area to select it, then using the VALUE dial to change the volume.

- To return to the Keyboard Tracks view, press the TRACK SELECT button again.

Turning the Style tracks on/off

You may easily turn on or off any Style track while you are playing. For example, try muting all accompaniment tracks, while drums and bass continue to play.

- Be sure the Volume panel is shown, or touch the Volume tab to show it.

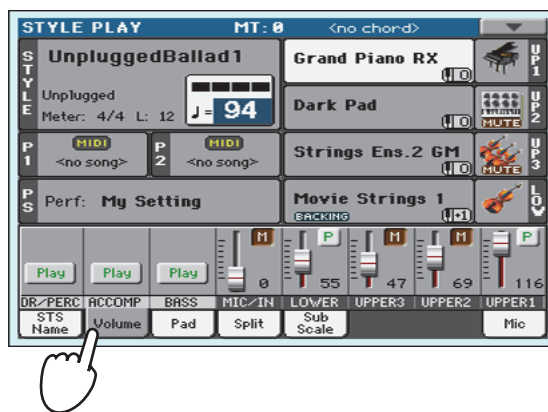

i Note: While in the Normal view of the Style Play mode, you can see Style tracks grouped in just three "grouped" tracks. To see each Style track as separate, individual tracks, just press the TRACK SELECT button.

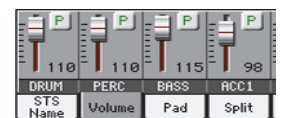

- While the Style is playing, touch the Play button to set the track to Mute.

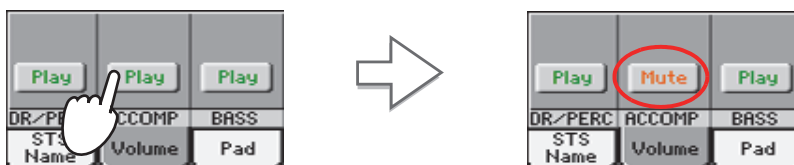

Mute the ACCOMP track. All accompaniment tracks will go silent (apart from Drum, Percussion and Bass).

- To set the tracks back to the Play status, touch the Mute icon on the muted track.

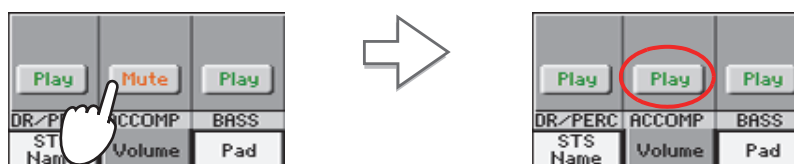

Set the ACCOMP track to Play. All accompaniment tracks will return to their original volumes.

- 4 To mute/unmute each single Style track, first press TRACK SELECT to switch to the Style Tracks view, then repeat the above procedure.
- 5 Press the TRACK SELECT button again to go back to the Normal view.

Adding harmony notes to your right-hand melody with the ENSEMBLE function

Chords played with your left hand may be applied to the right-hand melody.

- 1 Press the SPLIT button to turn its LED on and split the keyboard.

The Ensemble function only works in Split mode.



- 2 Press the ENSEMBLE button to turn its LED on.



- 3 Play chords with the left hand and single notes in the right hand.

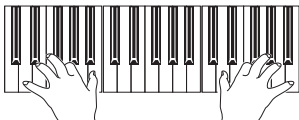

Notice how the right hand is automatically harmonized, according to the chords composed with your left hand.

- 4 To select a different harmonization style, keep the SHIFT button pressed, and press the ENSEMBLE button to open the Ensemble page.

This is a fast 'shortcut' to recall this page. The longer procedure would have consisted in accessing the Edit mode by pressing the MENU button, touching the Keyboard/Ensemble section, and then going to the Ensemble page.

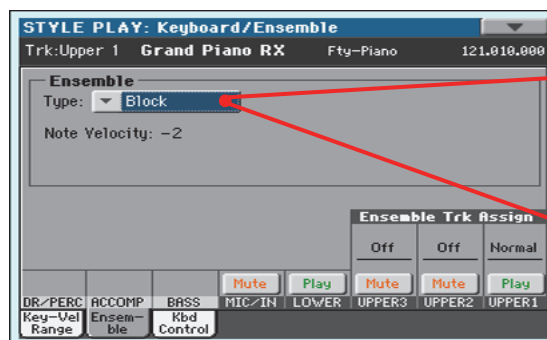
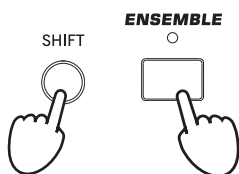

While the Ensemble parameter is selected, use the VALUE dial to select one of the available harmonization types.

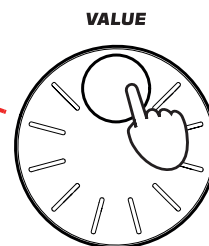

- When the right harmonization type has been selected, press the EXIT button to go back to the main page.

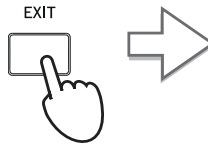
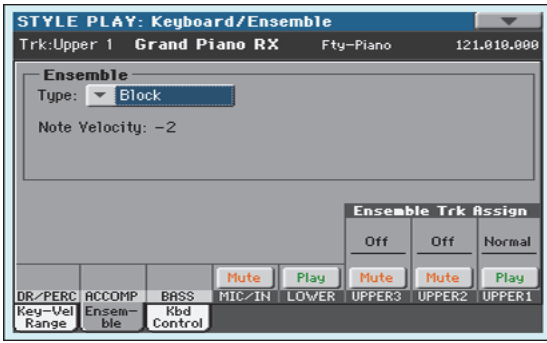

While in an Edit page, press EXIT to go back to the Main page of the current operating mode.



- Press the ENSEMBLE button again to turn its LED off. The automatic harmonization will be turned off.

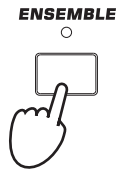

The Chord Sequencer

In case you need both hands free for playing a solo while a Style is playing, you can record a Chord Sequence and let Pa900 play the chords for you.

- 1 Press the **START/STOP** button to set the Style to play.
- 2 Press the **BASS INV.** and **M. BASS (RECORD)** buttons together to start recording.

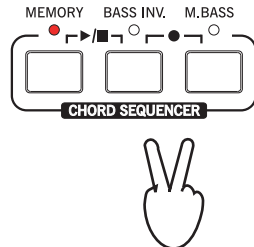

- 3 Start recording your Chord Sequence at the beginning of the next measure.

While recording, you will see a red flashing icon in the display.



- 4 Play the chords in the chord scan area.

The chord scan area is under the Split Point if the SPLIT LED is turned on. Usually, it is over the whole keyboard if the SPLIT LED is turned off. The chord scan area also depends on the status of the Chord Recognition parameter (Global > Mode Preferences > Style).

- 5 When the Chord Sequence is done, press the **BASS INV.** and **MAN. BASS (RECORD)** buttons together again to stop recording.

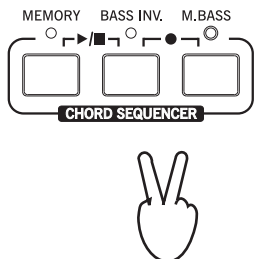

i Hint: You can avoid stopping the Chord Sequencer after recording, and immediately set the Sequence to play, as explained in the following step.

- 6 Press the **MEMORY** and **BASS INV. (PLAY/STOP)** buttons to start playback.

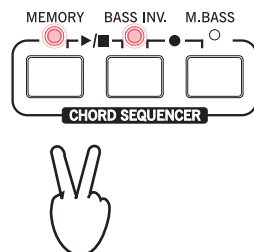

The LED of the two buttons will start flashing. The Chord Sequence will be played back in loop starting from the next measure. Recorded chords will be sent to the arranger, and the Style will play with the recorded chords.

- 7 Play your solo part, while the Chord Sequencer plays the chords for you.

During Chord Sequence looping, you can freely select any Fill or Variation, as if you were playing chords with your hands.

- 8 Press the **MEMORY** and **BASS INV. (PLAY/STOP)** buttons together again to stop playback of the recorded Chord Sequence.

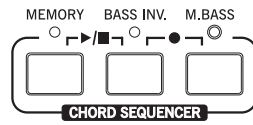

The last chord played by the Chord Sequence remains in memory. The Chord Sequence will remain in memory up until you record a new Chord Sequence, or you set Pa900 to standby.

Song Play

Pa900 is equipped with two onboard Players that can be run at the same time to mix different Songs. The Players can read Songs in Standard MIDI File (MID), Karaoke™ (KAR) and MP3 format.

It may be of great interest to singers and guitar players to know that if a Standard MIDI File or an MP3 file contains lyrics and chords, they can be seen in the display. Lyrics can also be seen on an external video monitor. Lyrics in the graphical “+G” format are also supported.

In addition to lyrics and chords, with Standard MIDI Files and Karaoke files you can also see the score in traditional notation, as well as the markers, to quickly jump to any section of a Song.

The SONG PLAY button

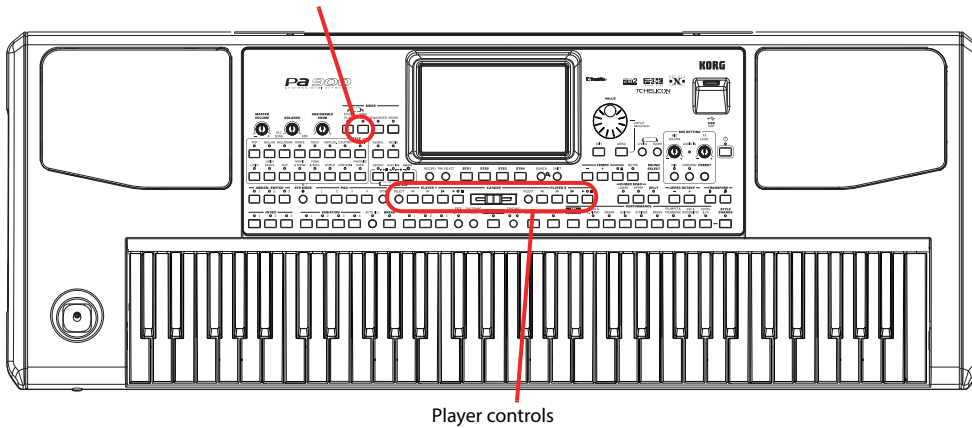

Selecting a Song to play

- 1 Press the SONG PLAY button to switch to the Song Play mode.

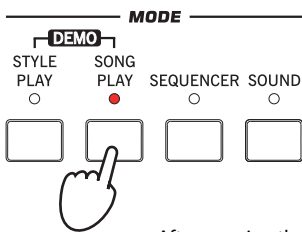

After pressing the SONG PLAY button, the main page of the Song Play mode appears.

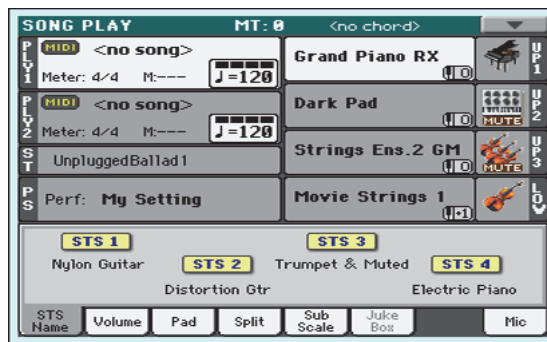

i Hint: In Style Play mode, you can pre-select the Song to be assigned to the Player. This way, you will be ready to start it, as soon as you switch to Song Play mode.

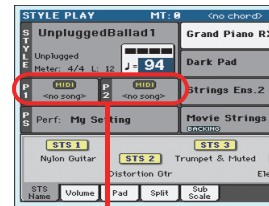

The Song area of the Style Play main page.

2 Touch the Player 1 area to open the Song Select window.

This window is very similar to the one you can see when pressing the MEDIA button on the control panel, and touching the Load tab to see the Load page. This page is, however, “filtered” to only show Song files.



i Hint: As an alternative, you can open the Song Select window by pressing the SELECT button in the PLAYER 1 section on the control panel.

3 Scroll through the list and select the Song to play.

The selected Song is highlighted. Touch a Song's name to select it.

Use the scroll bar or the VALUE DIAL to see all the Songs in the list. Keep SHIFT pressed and touch the Up/Down arrow to jump to the next/previous alphabetic section.

Touch the Select button to select the highlighted Song, and assign it to the Player.

Use the Device pop-up menu to select one of the available mass-storage devices.

Use the Open and Close buttons to browse through the folders.

Use the Locate button to 'locate' and go to the folder of the selected Song.

4 When the Song is selected, touch the Select button to confirm your selection; this will automatically close the Song Select window.

Selected Song

After touching the Select button in the display, the main page of the Song Play mode will appear again.

Playing back a Song

Once a Song has been selected, it may be played back by the Player.

- 1 Be sure the X-Fader is completely moved to the left (toward Player 1).

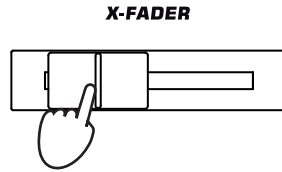

- 2 Press the ►/■ (PLAY/STOP) button in the PLAYER 1 section to start playback.



- 3 Use the PLAYER 1 control section to control the Song's playback.

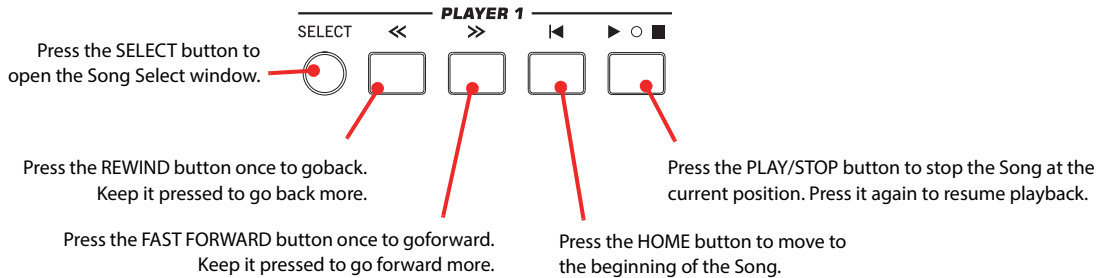

- 4 When you want to stop the song and go back to the beginning, press the ◀ (HOME) button.

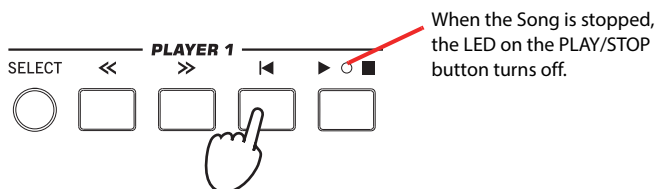

i Note: In any case, the Player will automatically stop when the end of the Song is reached.

Changing the tracks' volume

While playing back a Standard MIDI File, you may wish to change each track's volume, to create a mix "on the fly".

- 1 Be sure the Volume panel is shown, or touch the Volume tab to show it.

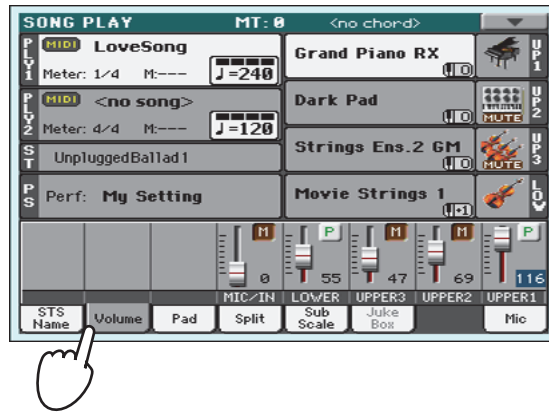

- 2 As seen for the Styles, you can hold & drag the Virtual Sliders on the display to adjust each track's volume. Use the TRACK SELECT button to cycle between track groups.

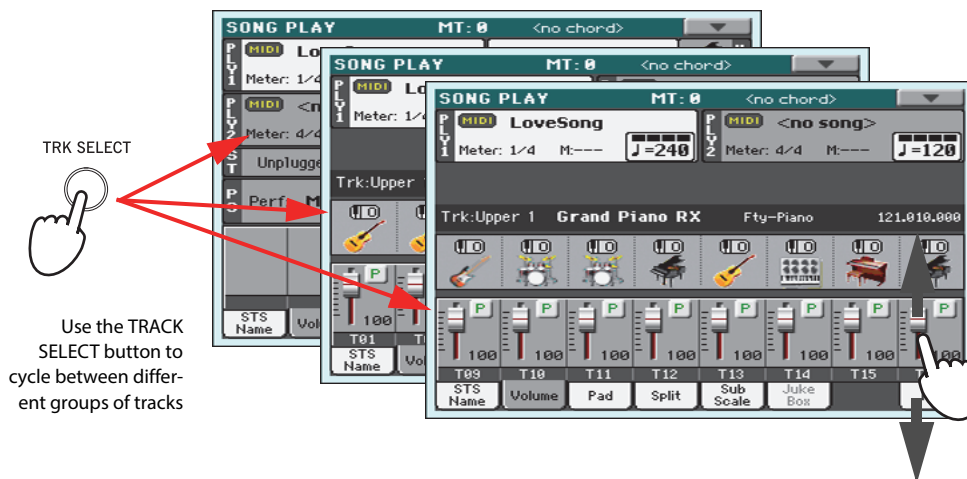

- 3 In Normal view, you can adjust each Keyboard track's volume.

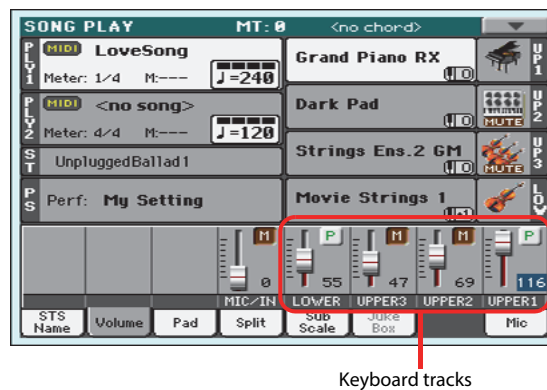

i Hint: As an alternative, you can change each track's volume, by touching a track's volume, by touching a track's area to select it, then using the VALUE dial to change the volume.

4 Press the TRACK SELECT button once to see tracks 1-8 (Track 1-8 view).

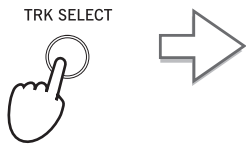

In Track 1-8 view, the first 8 tracks of the selected Song are shown.

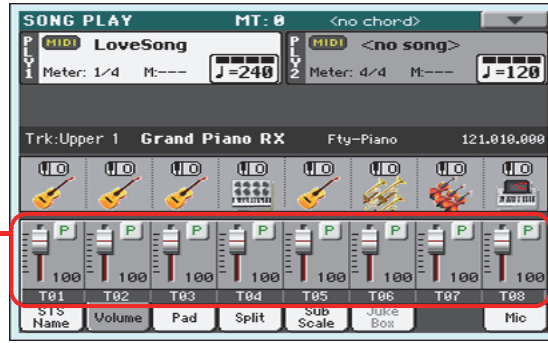

i Note: Changes to Song tracks will not be saved, and are reset each time you press the (Home) button, or you select a different Marker. To save changes, you must edit the Song in Sequencer mode.

5 Press TRACK SELECT once again to see tracks 9-16 (Track 9-16 view).

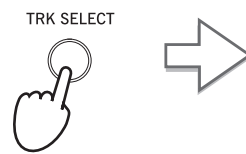

In Track 9-16 view, the second group of 8 tracks of the selected Song are shown.

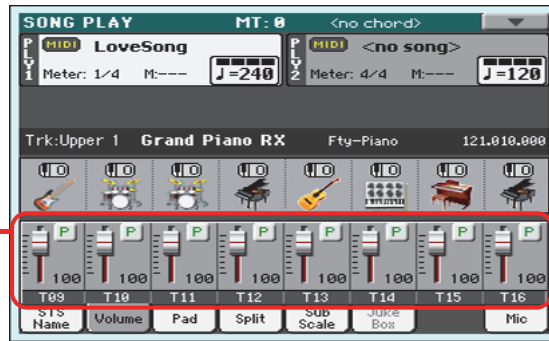

6 Press TRACK SELECT again, to return to the Normal view (Keyboard tracks).

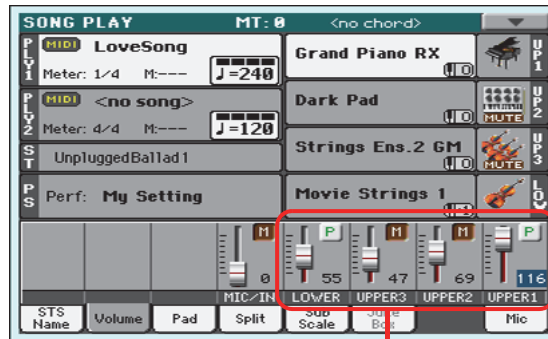
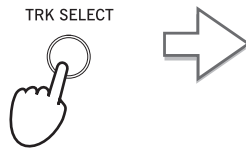

Keyboard tracks

7 Press the (PLAY/STOP) button to start the Song.

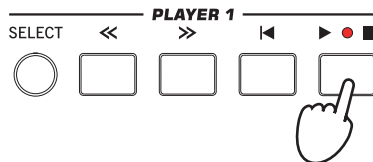

8 While listening to the Song, switch from Normal view to Track 1-8 and Track 9-16 view, to see which tracks are playing.

To see if a track is playing, look at the label with its name, and see if it is changing color.

- Touch each track's channel strip, to see each track's detail in the Track Info line.

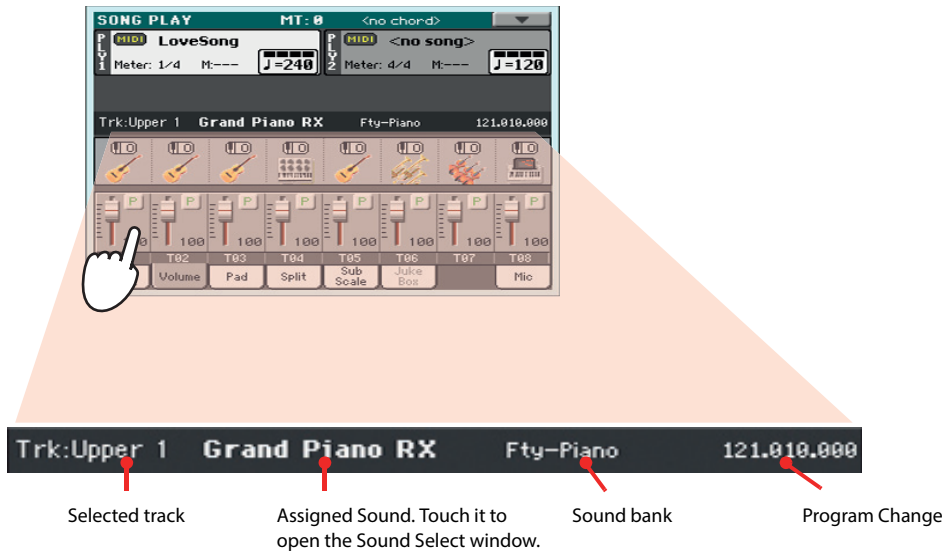

- Also, you can see which type of Sound is assigned to each track in the Sound area of the Track 1-8 and Track 9-16 views.

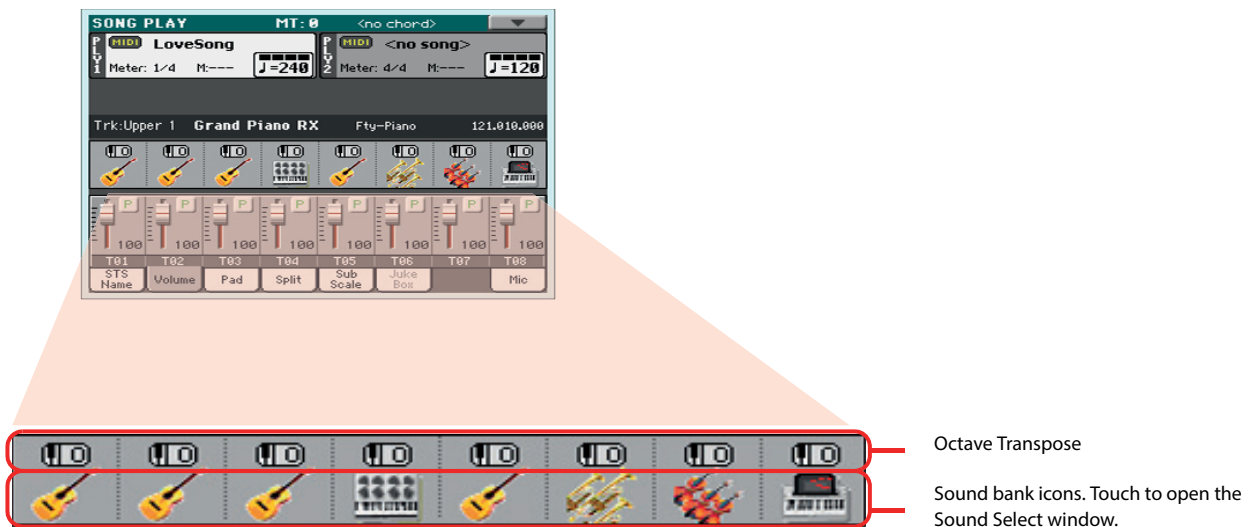

Turning the Song tracks on/off

While playing back a Standard MIDI File, you may wish to mute one or more tracks, for example to sing along with the Song, or play an instrumental part live on the keyboard.

To mute/unmute Song tracks you simply touch the Play/Mute icon in the Volume panel.

Soloing a track

Opposite to the above, you may want to make a single track of a Standard MIDI File play alone. This is called the Solo function.

- 1 While the Song is playing, keep the SHIFT button pressed and touch the track you want to listen to in Solo mode.
- 2 To set all tracks back to the Play status, keep the SHIFT button pressed again, and touch the track that is currently in Solo mode.

Please remember that you can also use the Solo function in Style Play and Sequencer mode. The Solo command can also be selected from the page menu.

Removing the Melody track from a Standard MIDI File or the Lead Vocal from an MP3 file

If you want to sing along with a Song (in Standard MIDI File or MP3 format), you can remove the Melody track or the Lead Vocal from the Song. Please note that removing the Lead Vocal from an MP3 file may be more or less effective, depending on the Song.

Programming the Assignable Switches

- 1 Program the Assignable Switches as the Song-Melody and Vocal Remover switches.

Press the MENU button, and choose the “Pad/Assignable Switch” section. Then touch the Switch tab to open the “Switch” page. While in this page, assign the Song-Melody function to the ASSIGNABLE SWITCH 1, and the Vocal Remover function to the ASSIGNABLE SWITCH 2:

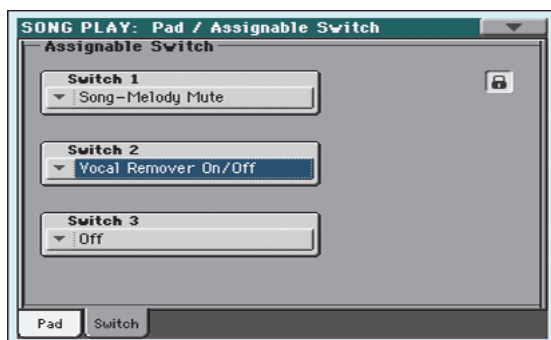

- 2 Press the EXIT button to return to the main page of the Song Play mode.

Using the Assignable Switches with a Song

- 1 Assign a Song (either in Standard MIDI File or MP3 format) to Player 1.
- 2 Start Player 1.
- 3 Press the ASSIGNABLE SWITCH 1 to mute the Melody track, or the ASSIGNABLE SWITCH 2 to activate the Vocal Remover, and remove the Melody track or the original lead singer's voice.

Listen how the Melody track disappears. If it is the wrong track, continue to the instructions below to select a different track.

Or, listen to how the original lead singer's voice is reduced or totally removed.

i Hint: You can open this page by keeping the SHIFT button pressed and pressing one of the ASSIGNABLE SWITCHES.

i Note: The Assignable Switches' assignment can be saved into each Performance or STS.

- 4 When done, you can press the **ASSIGNABLE SWITCH 1** to unmute the Song's Melody track and let the original MIDI instrument play the Melody line again, or press the **ASSIGNABLE SWITCH 2** to deactivate the Vocal Remover and let the original lead singer's voice appear again.
- 5 Stop the Player.

Choosing a different Melody track

You can choose a different Melody track, in case the Standard MIDI Files does not use a standard configuration of tracks.

- 1 Keep the **SHIFT** button pressed and press the **SONG PLAY** button to open the **Global > Mode Preferences > Song Play & Sequencer** page.

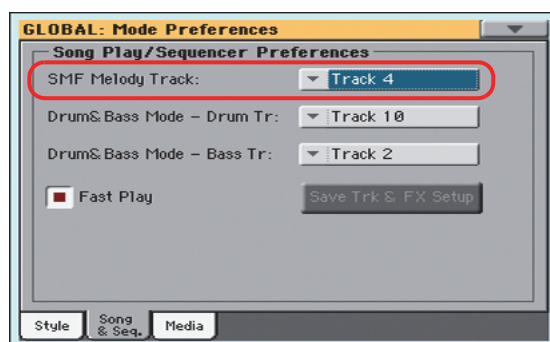

- 2 Choose a different Melody track.
- 3 When done, press **EXIT** to return to the main page.

Mixing two Songs

You can select two Songs at the same time, and mix them by using the X-FADER slider.

- 1 Touch the Player 1 area to open the Song Select window and select the Song to be played by Player 1. Touch Select to confirm.

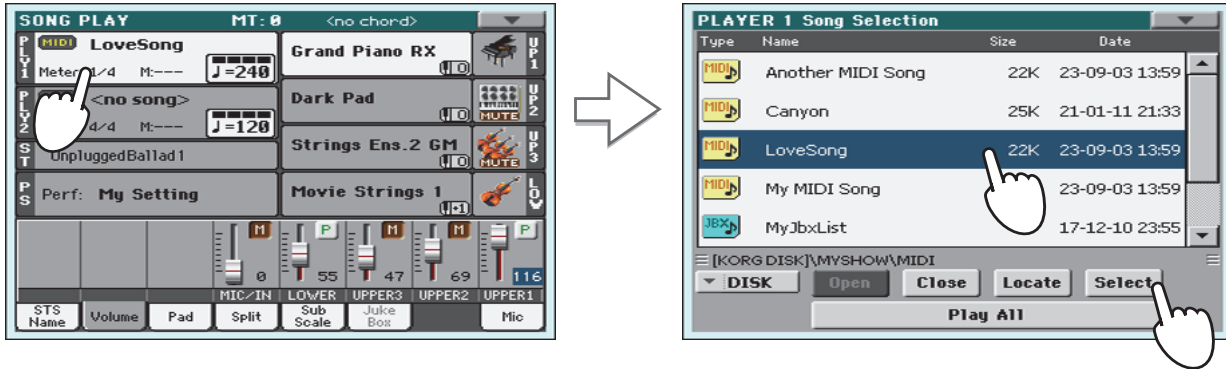

- 2 Once a Song is assigned to Player 1, touch the Player 2 area once to select it, and a second time to open the Song Select window. Select a Song to be assigned to Player 2, and touch Select to confirm.

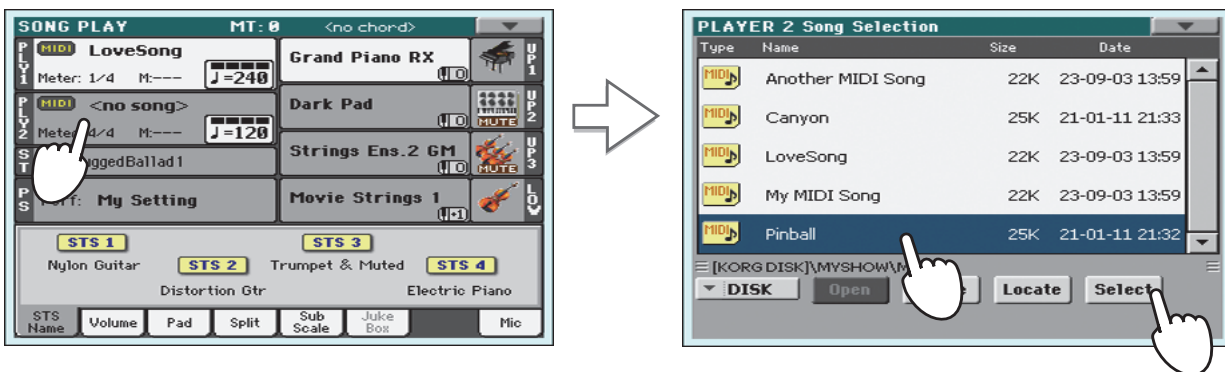

- 3 Keep the SHIFT button pressed, and press any of the two ►/■ (PLAY/STOP) buttons, to start both Players at the same time.

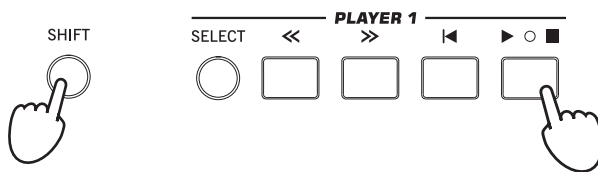

i Hint: You don't need to start both players at the same time. You can start the first Song – then start the second one when the first one is near to the end. This way, you can use the X-FADER slider to gently crossfade between the end of one Song and the beginning of the following one.

- 4 During playback, move the X-Fader, to mix between the two Songs.

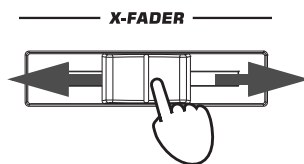

- 5 During playback, you may control each Player separately, by using the dedicated Player controls.

- 6 Press the relevant ►/■ (PLAY/STOP) button to stop the corresponding Player.

The SongBook

One of the most powerful features of Pa900 is the onboard music database, that allows you to organize your Styles and Songs for easy retrieving. Each Entry of this database may include the artist, title, genre, number, key, tempo, and meter (time signature) of a specified song. When selecting one of the Entries, the associated Style, Standard MIDI File or MP3 file – as well as the Style Play or Song Play mode – is automatically recalled. A Voice Processor Preset is also recalled.

In addition to helping you organize your shows, the SongBook allows you to assign up to four Pads, and up to four STSs to each Entry. Also, you can link a text file to any Entry, to be used as the Lyrics of a song, even if there are no Lyrics events in the associated Standard MIDI File or MP3 file, or if you prefer to play the song live with the backing of the Styles.

You can add your own Entries to the SongBook, as well as edit the existing ones. Korg has already supplied some hundred Entries as standard. Furthermore, the SongBook allows you to create various custom lists, that may suit your different types of show.

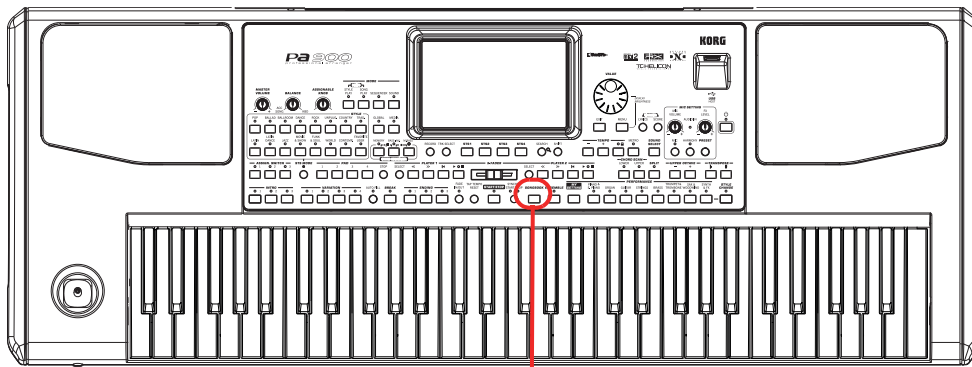

The SONGBOOK button

Selecting the desired Entry from the Main List

A large database is already included with the instrument, and you can later customize it. You may browse through this database in a variety of ways.

- 1 While you are in Style Play or Song Play mode, press the SONGBOOK button to open the SongBook window.

Style, Standard MIDI File(s) or MP3 file(s) currently assigned to the arranger or player(s)

SONGBOOK

SongBook Main List

Touch this checkbox to turn the view filter on.

Type	Name	Genre	Key	Bpm	Meter
STY	1000giorni di noi	Ballad	----	86	4/4
STY	6+1 days	Pop	----	100	4/4
STY	A day in Paradise	Ballad	----	96	4/4
STY	A felicidad	Latin	----	170	4/4
STY	A gigolo	Pop	----	130	4/4
STY	A hard day/night	Pop	----	148	4/4

Touch this button to edit the view filter.

Adds the selected Entry to the Custom List (if activated – see page 79).

Touch this button to select the current Entry to play.

Use the scroll bar or the VALUE DIAL to see all the Songs in the list. Keep SHIFT pressed and touch the Up/Down arrow to jump to the next/previous alphabetic section.

2 Browse through the Entries.

Icons in the Type column will help you identify the type of the Entry. The Genre column is shown by default, but you can switch to the Artist column (see “Displaying Artist or Genre” below).

3 When the Entry you are looking for becomes visible in the display, select it and touch the Select button in the display.

After selecting an Entry, the corresponding Style, MID, KAR or MP3 file will be recalled, together with the relevant operating mode (Style Play or Song Play). Up to four STSs and four Pads will also be recalled. Any TXT file associated with the Entry can be seen in the Lyrics page.

The selected Style, MID, KAR or MP3 file will be shown in the top area of the screen.

Displaying Artist or Genre

For space matters, either the Genre or Artist column can be seen in the display. You cannot see both at the same time.

1 Touch the page menu icon to open the page menu.

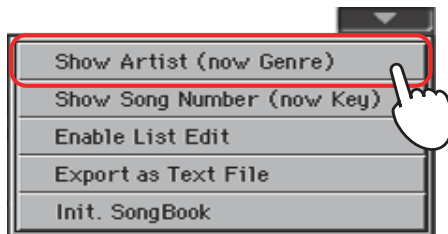

i Note: The Artist and Key fields of all supplied Entries have been intentionally left empty.

2 Choose Show Artist (now Genre) to switch from Genre to Artist in the List view. The Artist column will be shown.



3 Open the page menu again, and choose the Show Genre (now Artist) item. The Genre column will be shown again.

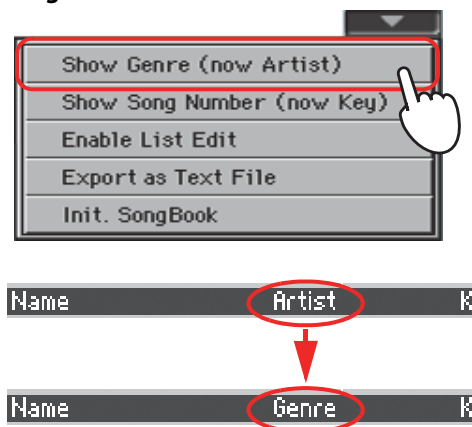

Sorting Entries

You can change the order of the Entries shown in the display.

- 1 You can change the sorting order by touching one of the labels in a list of names.

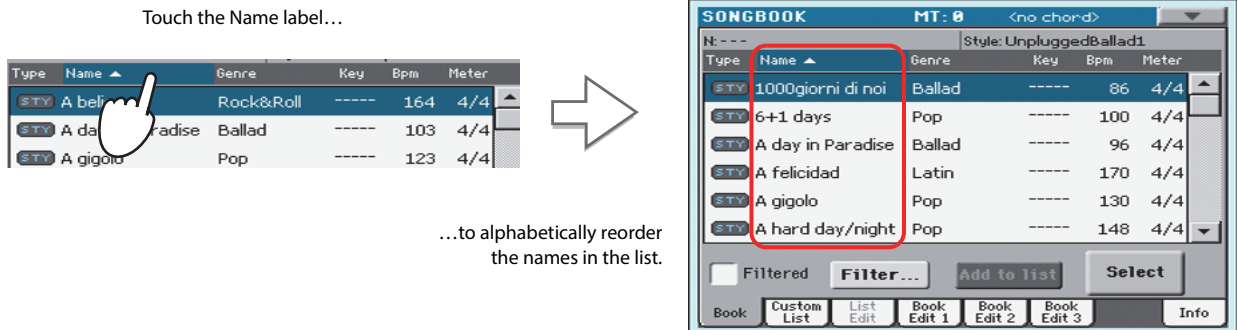

You can do the same by touching the Type, Name, Genre, Artist, Key, Number, Tempo or Meter label.

- 2 Each time you touch the same label again, the order changes between ascending and descending.

Searching for Entries

The SongBook database may be really huge. You can, however, look for (say) specific artists or song titles, using the filtering functions.

- 1 Touch the Filter button in the display, to open the Filter dialog box.

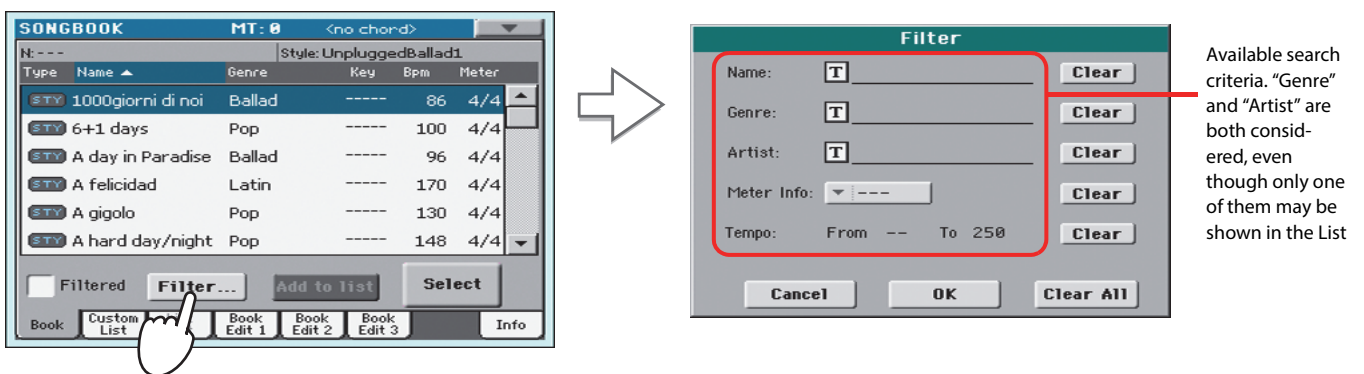

- 2 Touch the **T** (Text Edit) button next to the search criteria (even more than one) you want to enter.

For example, you may want to find all songs containing the word “love” in the title (in any position in the string). If so, select the ‘Name’ criterion, and enter the word ‘love’. Capitals are not relevant for the search.

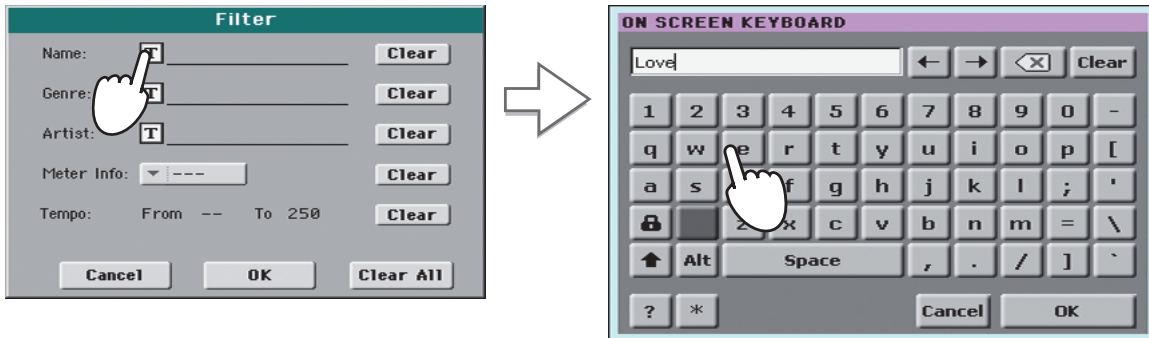

- 3** Touch OK in the display, and close the Text Edit dialog box. The entered text is now the search criteria.

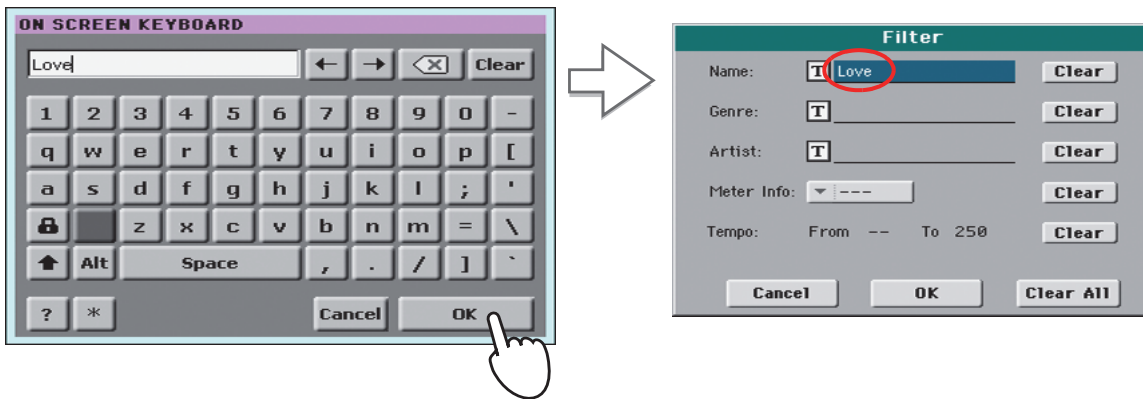

- 4** Touch OK to close the Filter dialog box and return to the SongBook page.

Once the Filter dialog box has been closed by touching OK, the Filtered check box is automatically checked, and the filter is activated. Only Entries matching the entered criterion are seen in the Main List.

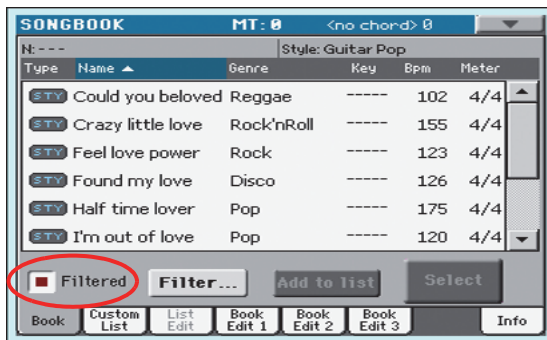

- 5** To see the whole SongBook database again, touch the Filtered check box again, to make the check mark disappear.

Adding Entries

You can add your own Entries to the SongBook database.

- 1 Go to the Style Play or Song Play mode, depending on the type of Entry you want to add to the SongBook database.**

- 2 Select the Style, Standard MIDI File or MP3 file to be added to the SongBook.**

Assign the Song to Player 1 (only Songs assigned to Player 1 will be saved to the SongBook Entry).

- 3 Edit the Keyboard and Style tracks the way you prefer, by selecting different Sounds and Effects, or editing any other relevant parameter.**

Please note that changes to Standard MIDI File tracks will not be saved as SongBook data. Only the data included in the Standard MIDI File will be used.

- 4 Choose a Voice Processor Preset.**

- 5 When ready, keep the SONGBOOK button pressed for about one second to create a new SongBook Entry with the current settings.**



- 6 Touch the **T** (Text Edit) button to assign a name to the Entry, then touch OK to save the Entry to the SongBook database.**

Editing the Entries

You can edit any SongBook Entry and customize it according to your taste. When done, you can overwrite the current Entry or save it as a new Entry.

- 1 Press the SONGBOOK button to access the SongBook pages.**

- 2 Touch the Book Edit 1 tab to see the Book Edit 1 page and see the linked Musical Resources.**

While in the Book Edit 1 page, you will be able to see the name of the selected Style or Song, and choose whether to replace them or not.

Name of the Style or Song file linked to the Entry.

Name of the Entry

Song Selection number (ID number for numeric selection)

If checked, the current Style track settings, or the path of the Song file (shown on the right), are saved with the Entry. If unchecked, current settings are left unchanged. This parameter is automatically checked when touching the New Song button to create a new Entry.

If checked, you can either save all the current STSs into the Entry, or choose a single STS where to save the current Keyboard track settings.

If checked, you can save the current Voice Processor Preset into the Entry. If left unchecked, current settings are left unchanged.

(This is just an indicator). When it appears checked, the VP Preset you are saving corresponds to the Global Voice Processor Preset.

3 When done with this page, touch the Book Edit 2 tab to see the Book Edit 2 page and edit the SongBook database details.

Database Entry's parameters

4 Touch the **T** (Text Edit) button next to the field(s) you want to edit. Set all the other parameters.

You can write the Genre and Artist name. Select a Tempo matching the Song's Tempo, and select the Meter (Time Signature) and Key of the Song. You can also specify a Master Transpose value, to be automatically selected when selecting the Entry.

Note: The Master Transpose might not change, if a Lock is preventing it. See Global > General Controls > Locks.

5 When done with this page, touch the Book Edit 3 tab to go to the Book Edit 3 page, where you can and set the Synchro and Memory parameters, and link a text file to the Entry.

Synchro (for Style) and Memory (for Style and Songs) On/Off status

Text file linked to the Entry. This text will be seen in the same way of ordinary Lyrics in the display (or in the external monitor).

- 6 After having filled up all the desired fields (be as comprehensive as you can), touch the Write button in the display to open the Write dialog box.

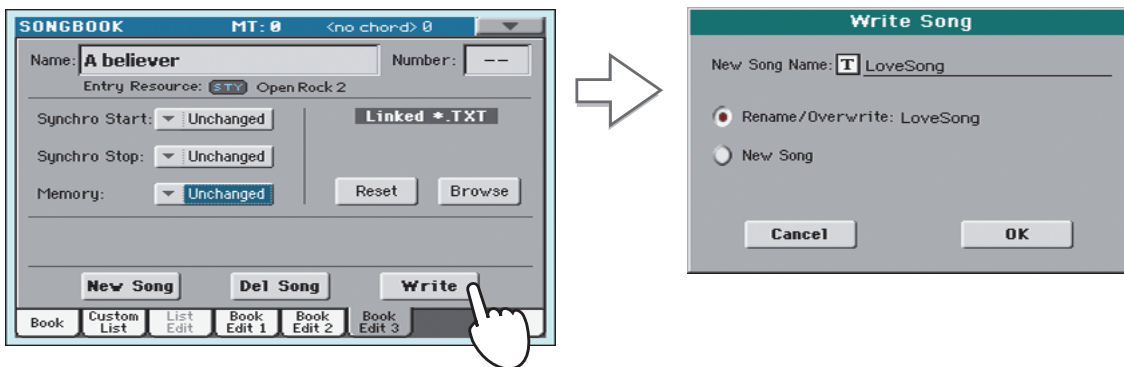

- 7 Touch the **T** (Text Edit) button to assign a name to the Entry, then touch OK to save the Entry to the SongBook database.

Select Rename/Overwrite to replace an existing Entry. This option is automatically selected when editing an existing Entry; it cannot be selected when saving a new Entry. **Warning: the older Entry will be deleted!**

Entry's name. By default it is the same name of the associated Style, Standard MIDI File or MP3 file. The name can be up to 16 characters long.

Select New Song to add a new Entry to the SongBook database. This option is automatically selected when a new Entry has been created (by touching the New Song button).



Creating a Custom List

You can create several Custom Lists in the SongBook, to make a set of Entries suitable for your various shows. Before starting a new Custom List, be sure you have added all needed Entries to the SongBook main database (see "Adding Entries" above).

- 1 While in SongBook mode, open the page menu and check the 'Enable List Edit' item.

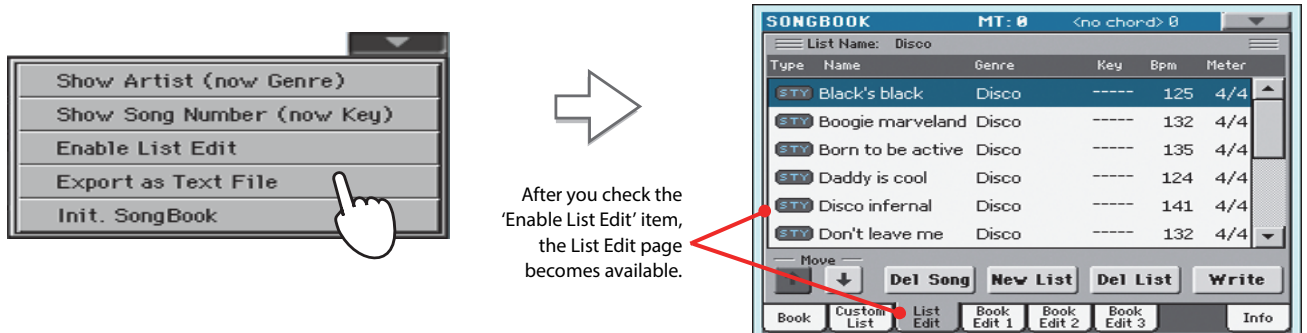

- 2 Select a Custom List to be edited.

To edit an existing list, touch the Custom List tab to open the Custom List page, and select one of the available Custom Lists. To create a new list, touch the List Edit tab to open the List Edit page, and touch the New List button to create a new, blank list.

3 Touch the **Book** tab to open the **Book** page and see the full database. Use the various sorting, searching and filtering options (seen above) to find the **Entries** you are looking for. Touch the **Add to List** button when the desired **Entry** has been selected.

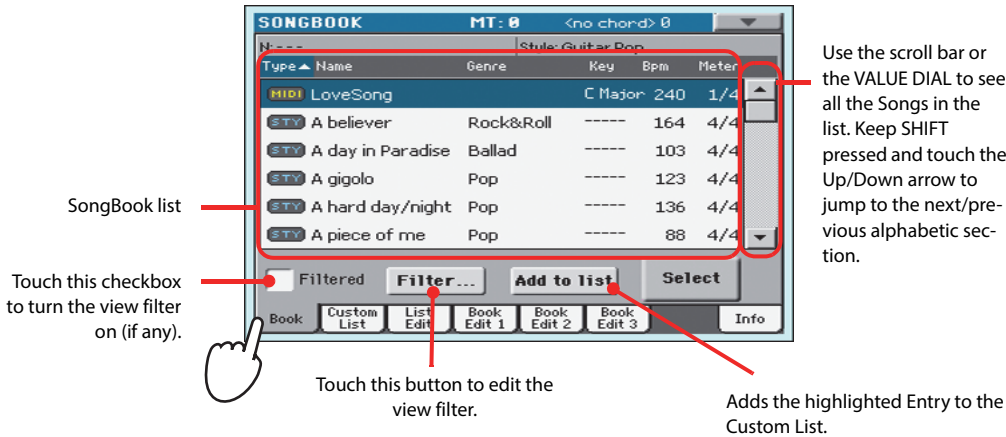

4 When finished adding **Entries** to the **Custom List**, touch the **List Edit** tab to go to the **List Edit** page, and use the various commands to edit the list.

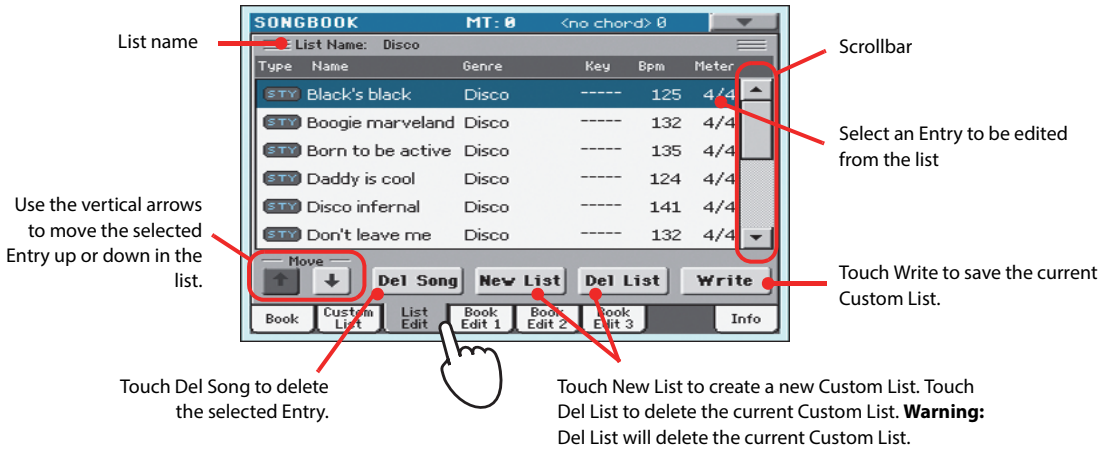

5 When the **Custom List** is ready, touch the **Write** button in the display to save it to memory. Assign a new name to the **Custom List**.

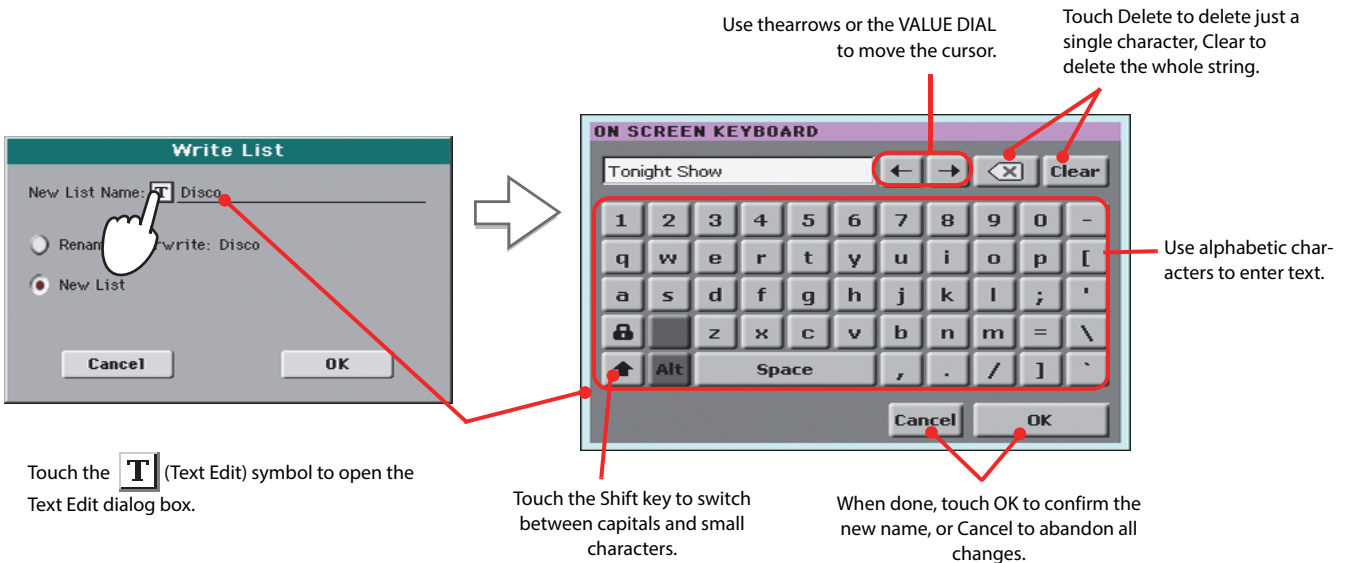

6 When finished editing the **Custom List**, open the page menu and uncheck the 'Enable List Edit' item.

Selecting and using a Custom List

After having created one or more Custom Lists, you can select one and use it for your show.

- 1 Touch the Custom List tab to select the Custom List page.
- 2 Use the List pop-up menu to select one of the available Custom Lists.

Use the List pop-up menu to select one of the available Custom Lists.

Entry in play. To select a different one, highlight it and touch the Select button in the display.

Touch Select to set the highlighted Entry to play (if different than the one automatically selected).

Touch Next to select the next Entry in the list. (This command can also be assigned to an Assignable Switch).

Type	Name	Genre	Key	Bpm	Meter
STV	Black's black	Disco	----	125	4/4
STV	Boogie marveland	Disco	----	132	4/4
STV	Born to be active	Disco	----	135	4/4
STV	Daddy is cool	Disco	----	124	4/4
STV	Disco infernal	Disco	----	141	4/4
STV	Don't leave me	Disco	----	132	4/4

- 3 Select one of the Entries in the list (it turns blue), then touch the Select button in the display to confirm selection (the selected Entry turns green). Press the PLAY button to start playing back the selected Song.

Synchronizing the SongBook with external software

Additional software has been created to work with the SongBook. You can use Korg's own [SongBook Editor](#) to edit single entries, the SongBook database and the Custom Lists on a Windows PC. You can also use BauM Software's [SongBook+](#) for iPad, or ZuberSoft's [MobileSheets](#) for Android, to synchronize the SongBook entries with a tablet, and read lyrics and sheet music on the wider tablet display.

Other software is under development. Please check our web site regularly, for news about their release.

Singing with a microphone

Pa900 features a high-quality microphone input for a dynamic microphone. It also features a powerful digital voice processor, based on technologies developed by TC Helicon, including dedicated effects and three-part harmonization.

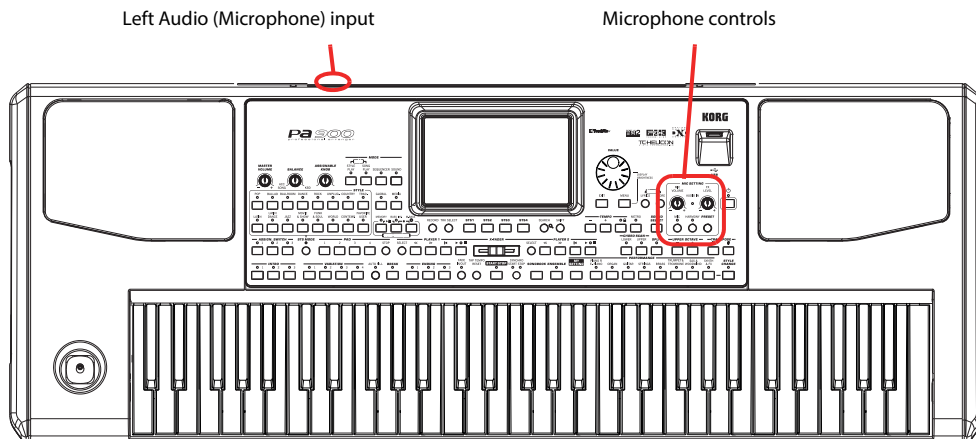

Connecting a microphone

To sing along with the Pa900, you must first connect a dynamic microphone to the LEFT audio input (the one that goes into the Voice Processor).

- 1 Press the **GLOBAL** button, touch the **“Audio & Video”** button in the display, then touch the **Audio In** tab to reach the **“Audio In”** page.

Be sure the “Input Routing” is set to “Left In to Voice Processor”.

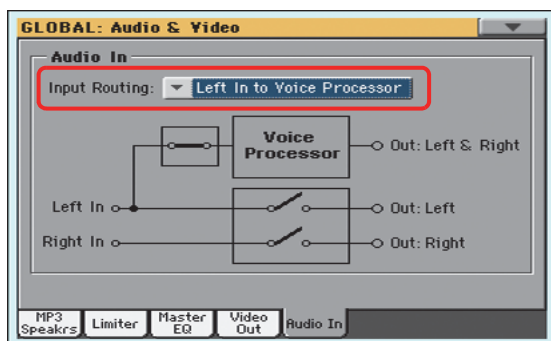

- 2 Press the **EXIT** button to return to the main screen.
- 3 Turn the **Microphone** input off by using the dedicated **MIC on/off** switch on the control panel, and lower the **MIC VOLUME** knob all way down.

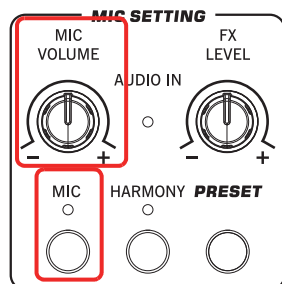

Note: Keeping the microphone level low helps avoiding feedback. Feedback is caused by audio generated by the Pa900, returning to the audio circuitry via the microphone.

4 Connect a microphone.

5 Turn the MIC switch on, and slightly increase the MIC VOLUME level. Sing into the microphone, and adjust the MIC GAIN until you achieve the correct settings.

Adjust the input level by using the MIC GAIN knob next to the LEFT audio input. Sing into the microphone, and watch at the AUDIO IN LED on the control panel – it ought to stay green. If it goes orange too often (or even red), turn down the input gain; if it turns off too often, increase the input gain. No hint of distortion should be heard in the audio system when you sing.

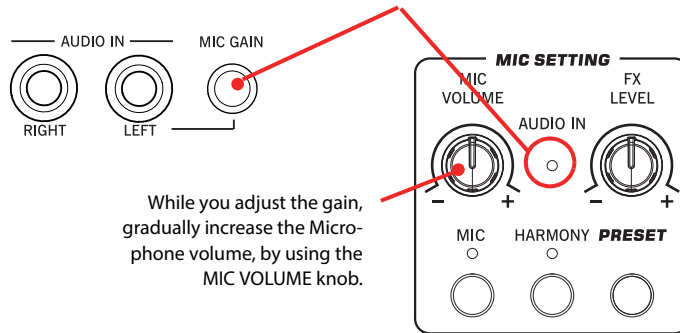

6 When the AUDIO IN LED shows the correct input level, use the MIC VOLUME knob to set the microphone volume in the mix.

Setting up your voice tone

You can add equalization, compression and gate to the microphone signal, to make your voice tonally pleasant and dynamically even. While these effects cannot be considered a replacement for some good training, they can fix a few common problems in a live context.

1 In case your voice is “boomy”, go to the Global > Mic > Global Setup page, by pressing the GLOBAL button, then touching the Mic button in the display, and then (if it is not selected) the Global Setup tab.

The Global Setup page appears in the display.

i *Hint:* You can keep the SHIFT button pressed, and press the MIC button, to jump to the Global Mic Setup page.

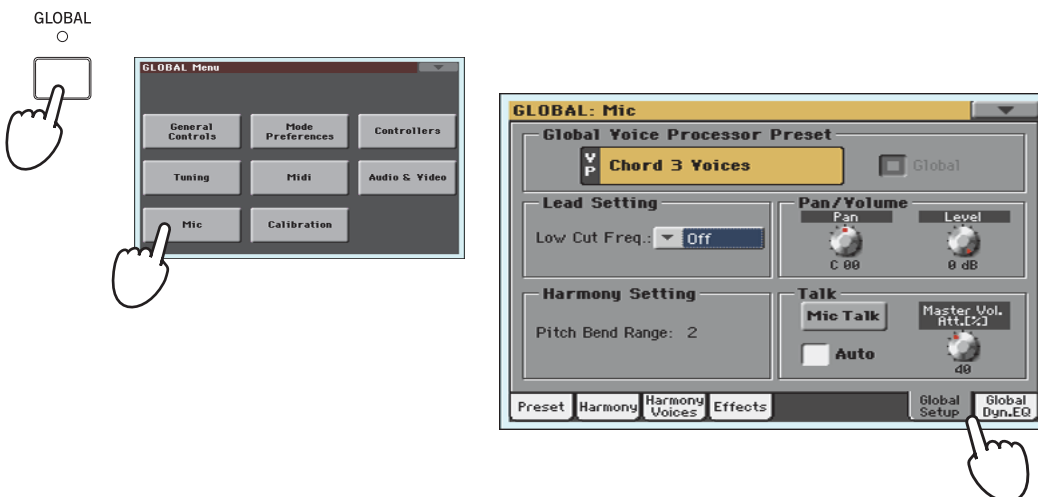

2 To filter out the “boominess”, use the “Low Cut Freq.” parameter and remove some bass frequencies.

Start with the lowest frequency, and then try to up in case it does not solve the problem. In some cases, boominess can be solved by singing a bit farther from the microphone.



3 Then, touch the Global Dyn./EQ tab and adjust the level and tone of your voice.

The Global Dynamics/EQ page appears.

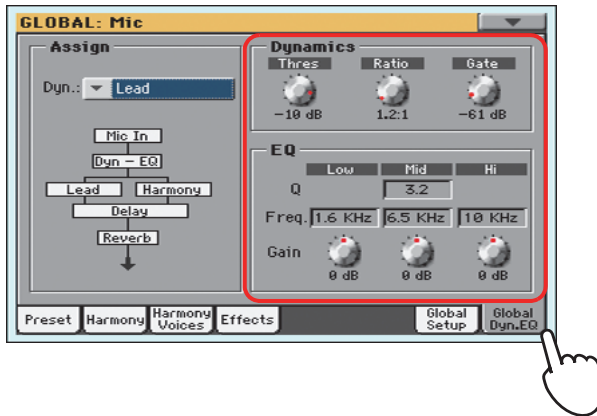

4 Adjust the Compression and Gate settings for your voice.

Adjust the Compressor’s Threshold and Ratio parameters, so that your voice sounds full and even. Use the Gate control to reduce the risk of feedback and the amount of environmental noise (from other musicians on stage, from the audience...).

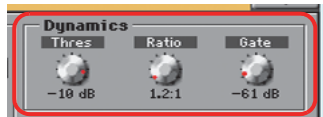

5 Then adjust the Equalization settings.

Use the EQ controls to adjust your tone. Increasing the High band gain adds an airy brightness, or “sizzle” to your voice; it can also increase sibilance. Increasing the Low band gain gives more “body” to your voice, but it can also increase “mud” due to the proximity effect from singing closely into a cardioid microphone. Increasing the Mid band gain increase the presence of your voice in the mix, but it can also make it sound a bit nasal.



6 Press the EXIT button to return to the main page.

7 Since dynamics and EQ can alter the volume level, adjust the volume levels again with the MIC VOLUME knob.

i Hint: You can also access the EQ from the Mic panel of the main screen.

Choosing a Voice Processor Preset

You can add several effects to your voice, and you can set them up quickly through the Voice Processor Presets. These are memories containing all the settings for the Voice Processor effects. You can customize these memories at will.

- 1 Press the PRESET button in the MIC SETTING sections, and choose one of the Presets from the VP Preset Select window.**

Voice Processor Presets (VP Presets) are settings for the various Voice Processor effects. By selecting a Preset, all processing parameters may change.

While a Global VP Preset is assigned globally, a “local” VP Preset can be assigned to each Performance, Style or SongBook Entry. When selecting one of these elements, the VP Preset may change, changing the type of processing applied to your voice. You can choose a VP Preset in the Mic tab of the main screen.

Press the PRESET button or touch the VP Preset name to select a VP Preset



When the Global option is checked, the Global VP Preset is used instead of the “local” one.

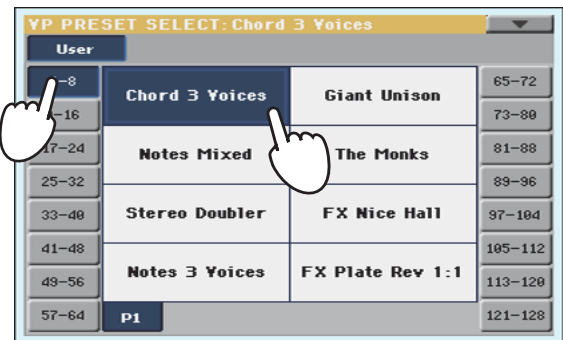

- 2 Sing into the microphone to listen to the effects.**
- 3 Adjust the level of the Reverb or Delay effect, by using the FX LEVEL knob in the MIC SETTING section of the control panel.**

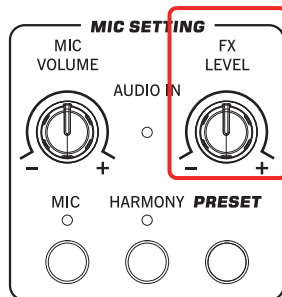

- 4 Choose a different Preset, and listen to how the effects have changed.**

Applying harmony to your voice while playing with the Styles

You can let Pa900 add automatically-generated harmonies to your lead voice, with up to three backing voices. Each VP Preset may contain a different harmonization style (for example, changing the number of voices, or the way notes are received from the keyboard, a Style or a Song).

Here, we will use a VP Preset set to sing over a Style.

- 1 Press the STYLE PLAY button to go to the Style Play mode, and choose the desired Style.**
- 2 Select the VP Preset “Chord 3 Voices”.**

This VP Preset expects you play chords, and receives notes from the Chord Scan area of the keyboard (the Harmony Mode is “Chord”).
- 3 Play some chords, to let the Voice Processor create new voices based on them, and sing along with the chords you play on the keyboard.**

Harmonizing will add chord notes to the note you are singing.
- 4 Stop the Style.**
- 5 Press the HARMONY button again, to turn its LED off.**

i Note: You can also use this VP Preset in Song Play mode, and play harmony notes in the Chord Scan of the keyboard.

Applying harmony to your voice while playing with a Song

Harmony notes can be received from a Song’s track. Here is how to use a VP Preset set to sing over a Song.

- 1 Press the SONG PLAY button to go to the Song Play mode, and choose the desired Song.**
- 2 Select the VP Preset “Notes 3 Voices”.**

This VP Preset expects notes from Track #5 of the Standard MIDI File (the Harmony Mode is “Notes”). To choose a different track keep the SHIFT button pressed and press the HARMONY button to see the Harmony page. Use the “Song Control” parameter to choose a different track.
- 3 Sing along with the Song, and let the Voice Processor create new voices based on the Harmony track of the Song.**
- 4 Stop the Song.**
- 5 Press the HARMONY button again, to turn its LED off.**

i Note: You can also use this VP Preset in Style Play mode, and play harmony notes over the full keyboard.

Balancing the voice, effects and tracks level

When all effects have been set, you can balance your voice against the effects, the Styles and the Songs.

- 1 If you like, start a Style or Song.**
- 2 Adjust the microphone's final volume by using the MIC VOLUME knob.**
The position of the MIC VOLUME knob is not saved to memory, so it remains consistent when selecting different Styles, Performances, Songs or Voice Processor settings.
- 3 If you are using the Harmony function, adjust the level of the harmony voices by using the "Harmony Level" parameter in the Mic panel of the main page.**

By default, this control is also assigned to the ASSIGNABLE KNOB.



- 4 Set the voice effects' level by using the dedicated FX LEVEL knob.**

Soloing your voice (Talk)

Sometimes, during a live show, you might like to talk to your audience. Use the Talk function to attenuate the music, and let your voice pass through clean and clear.

- 1 While in the main page of the Style Play or Song Play mode, touch the Mic tab to see Voice Processor's settings.**
- 2 During playback, turn the Talk function On.**



- 3 Sing or talk into the microphone.**
You'll hear that then background music has been made softer, while your voice will be heard *loud and proud*.
- 4 When done, turn the Talk function Off.**
The background music returns to the original volume.

Recording a new Song (Standard MIDI File)

There are several ways to create a Song on the Pa900. The easiest and fastest is to use the Styles to record what you are playing in realtime on the keyboard, while the arranger gives you the accompaniment tracks.

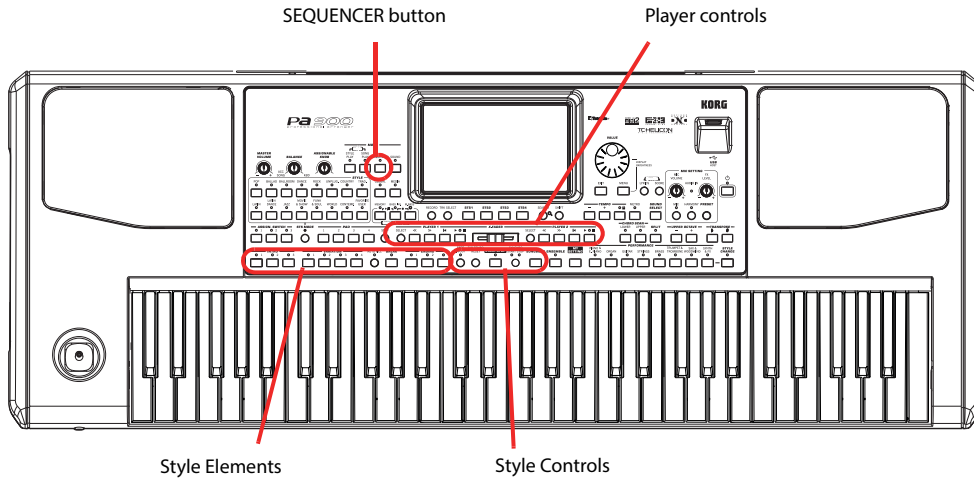

Preparing the Style and Sounds

Before accessing the Record mode, we suggest you prepare the Style and Sounds with which to record your Song.

- 1 Select a Style with which you want to record.
- 2 Select the Sounds by choosing a Performance or STS.

That's all! You are ready to access Record mode.

Accessing the Backing Sequence (Quick Record) mode

- 1 Press the SEQUENCER button to switch to the Sequencer mode.

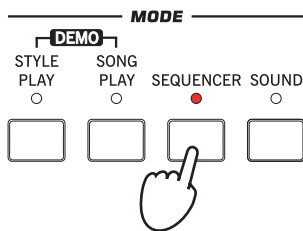

After pressing the SEQUENCER button, the main page of the Sequencer mode appears.



2 Press the RECORD button to open the Song Record Mode Select dialog box.



Press the RECORD button, to open the Song Record Mode Select dialog box



3 Select the Backing Sequence (Quick Record) option and touch OK to enter the Backing Sequence Record mode.



After having chosen the Backing Sequence (Quick Record) option, the Backing Sequence Record page appears.

Setting the Record parameters

When you enter Backing Sequence Record, the latest selected Style and Sounds are already selected, and all tracks are ready to record. You could simply start recording as if you were playing in realtime with the Styles. However, there are some further settings that you may want to do.

- **If you like, adjust any editable parameter in the display.**

Touch the Style parameter (or the STYLE button) to open the Style Select window, and select a different Style.

Track(s) status. 'Rec' means they are ready to record. 'Play' means they are recorded and you can hear them. 'Mute' means they cannot be heard.

Measure counter. The negative number (-1) is the precount, after which you can start recording.

Style's Tempo. Change it, if you like.

Style's Meter (or Time Signature). It's just an indicator, you cannot change it.

Touch the Perf/STS parameter to open the Performance Select window, and select a different Performance (as seen on page 45). As an alternative, you use the PERFORMANCE or STS buttons.

Grouped tracks. During Quick Record, you cannot access each separate Song track. For ease of use, just two 'master' tracks are provided: **Kbd/Pad** (Keyboard/Pads) and **Ch/Acc** (Chord/Accompaniment).

Recording

- 1 **Select the Style Element you wish to use before starting to play.**

Select any of the Variations before starting to record.
Select one of the Intros to start with an introduction.

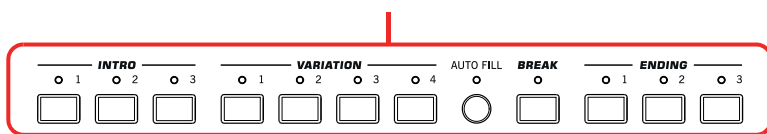

- 2 **Start recording, by pressing the START/STOP button.**

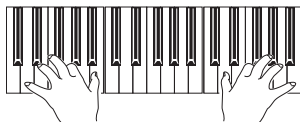

i Note: If you do not wish to start the Song with the Style already playing, you can simply start recording by pressing the **▶/■ PLAY/STOP** button in the **PLAYER 1** section, then start the Style only at a later time. The Style will start at the beginning of the following measure.

- 3 **Play as if you were performing live with the Styles.**

During recording, select any Style Element (Intro, Variation, Break, Ending...) you like. You can also press START/STOP to stop the Style, and press it again to start the Style again!

Please remember that, while recording in Backing Sequence Record mode, you cannot use the SYNCHRO, TAP TEMPO/RESET, BALANCE controls.

- 4** When finished recording your Song, press the ►/■ (PLAY/STOP) button in the PLAYER 1 section to exit recording, and return to the main page of the Sequencer mode.

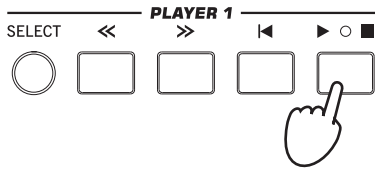

After pressing the PLAY/STOP button, the main page of the Sequencer mode will appear again.



- 5** While in the main page of the Sequencer mode, press the ►/■ (PLAY/STOP) button in the PLAYER 1 section to listen to the recorded Song.

The Backing Sequence Song has been converted to an ordinary Song (in Standard MIDI File, or “MID”, format). If you like it, you can save it. You can then read it in Song Play mode, or transfer it to any external sequencer.

- 6** If you want to edit the Song, press MENU to access Edit mode.

Second-take recording (Overdubbing)

You may want to record an additional “grouped” track, or replace a bad-recorded track with a new one. A good idea may be to record all chords and Style Element changes during the first take, then record Keyboard tracks and Pads during the second take.

- 1 Press the **RECORD** button to enter Record mode again. When the **Song Record Mode Select** dialog box appears, select **Backing Sequence (Quick Record)** again.
- 2 If you are recording just one of the “grouped” tracks, set to **Play** the track to be preserved.

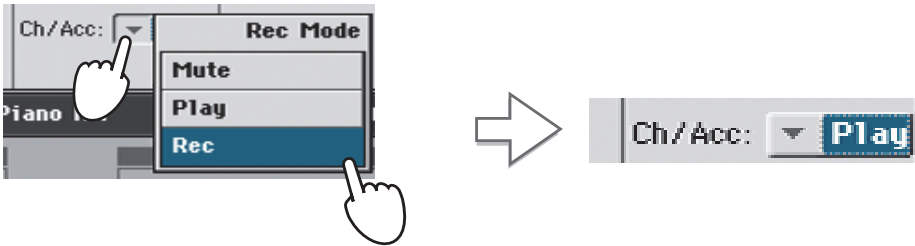

- 3 Repeat the recording procedure, and press the **▶/■ (PLAY/STOP)** button in the **PLAYER 1** section to stop recording and return to the main page of the Sequencer mode.
- 4 While in the main page of the Sequencer mode, press the **▶/■ (PLAY/STOP)** button in the **PLAYER 1** section to listen to the recorded Song.

Again, the Backing Sequence Song has been converted to an ordinary Song.

Saving a Song

After having recorded a Song that you like, it is a good idea to save it, to avoid losing it when the instrument is turned off (or put in standby).

- 1 While in the main page of the Sequencer mode, touch the page menu icon to open the page menu.

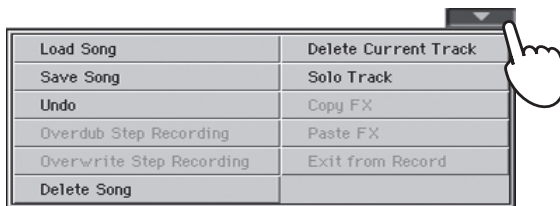

2 Select the Save Song command to open the Save Song window.

This window is very similar to the one you can see when pressing the MEDIA button on the control panel, and touch the Save tab to see the Save page. This page is, however, “filtered” to only see Song files.

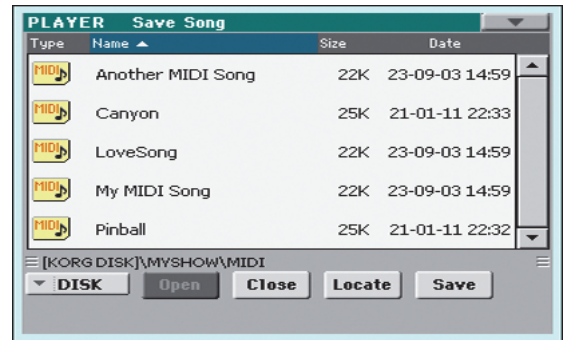
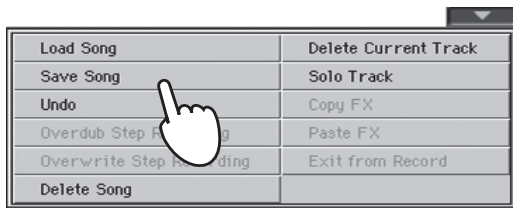

After you select the Save song command, the Save Song page appears.

3 Select a device and folder where you want to save your Song.

If a Song is selected (highlighted) it will be overwritten. If no Song is selected, a new Song file will be created on the target device. To deselect a selected Song, touch anywhere else in the Song list, or select the same storage device again.

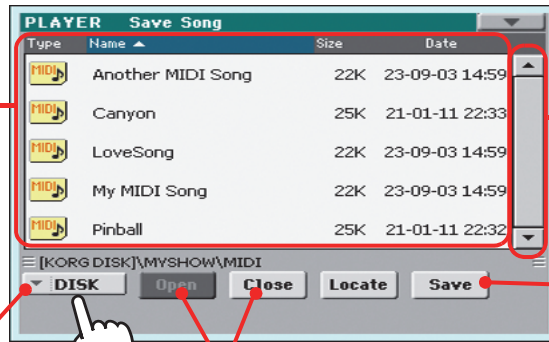

Use the scroll bar to see all Songs in the list. Keep SHIFT pressed and touch the Up/Down arrow to scroll to the next/previous alphabetic section. As an alternative, you can use the VALUE DIAL.

Touch the Save button to save the Song to the current folder.

Use the Device pop-up menu to select one of the available storage devices

Use the Open and Close buttons to browse through the folders.



In case you prefer to exit this page without saving the Song, press the EXIT button.

4 Touch the Save button in the display to open the Save Song dialog box.

Touch the Text Edit icon to edit the Song's name.

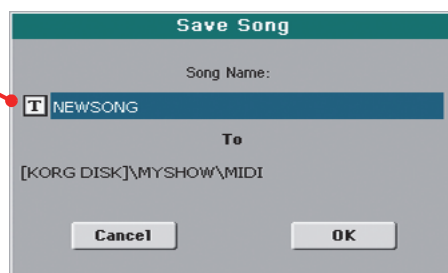

5 Touch OK in the display to save the Song, or Cancel to stop the Save operation.

Recording a new Song (MP3 file)

With Pa900, you can record your performance as an MP3 file. Keep in mind what follows:

- All you play on the keyboard, the Styles and the Standard MIDI Files performed by the Players will be recorded.
- Any audio signal entering the Audio Inputs is recorded (single microphone input with the “Mic In to Voice Processor” option selected, or the Left and Right line inputs with the “Audio In to Direct Out” option selected. See “Audio & Video: Audio In” on page 264). Harmony voices generated by the Voice Processor will be also recorded.
- You will not be able to load MP3 files while recording an MP3 Song, and you will not be able to record an MP3 Song while an MP3 file is playing.

You will then be able to play the resulting MP3 files using the Players, as with any other MP3 file.

1 To access recording, keep the SHIFT button pressed, and press the RECORD button.

The MP3 Record dialog box will appear.

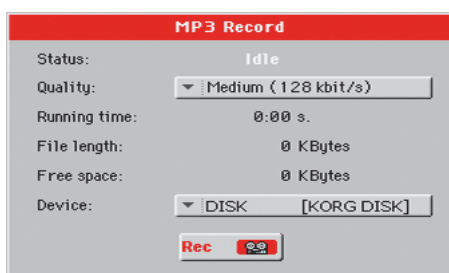

When not recording, the status shown is Idle.

2 Choose the preferred MP3 audio quality option, by means of the “Quality” pop-up menu.

The higher the sound quality, the larger the MP3 file that will be generated.

3 Use the “Device” parameter to choose a location where to temporary store the recorded MP3 file.

This is not the final destination of your file, since you will be able to choose a different location after recording. However, be sure there is enough space for the temporary file, by checking the “Free space” parameter.

The default device is automatically selected as the recording unit; use the Device pop-up menu to choose a different one. You can record to the internal memory or to a device connected to one of the USB ports.

4 When done, touch the “Rec” button in the display to start recording.

The “Rec” button changes to “Stop”, and can be touched again to stop recording. Also, the “Idle” label changes to “Recording”.



5 Start playing and singing your Song.

You can record everything you play; in addition, you can record your vocals. In other words, you can record your whole performance.

Note: You cannot enter MP3 Record mode while in Sequencer or Media mode.

Note: MP3 files recorded with lower sampling rates may not sound very good. This is a problem that cannot be avoided with MP3 files.

6 If you like, you can press the EXIT button to exit this dialog box and navigate through the Style Play and Song Play pages, without stopping to record.

7 To access the dialog box again, and see the file length or stop recording, press SHIFT+REC again.

During recording, if you exit from the MP3 Record dialog box while still recording, a red recorder icon will flash in the display.



During recording, you can use this dialog box to see the Recording time, file length, and the remaining space on disk. Maximum recording time depends on the available space in the selected device.

8 Touch “Stop” to stop recording.

After touching “Stop”, recording will stop, and the following dialog box will appear:



9 Touch the **T** (Text Edit) button to give the MP3 file a name.

10 Touch the “Browse” button to select a device and directory where to save the file.

11 Touch the “Save” button to save the file.

After saving, you can listen to the MP3 file in Song Play mode, as you do with any other Song.

The MP3 file can also be moved to a personal computer for further editing, by copying it to an USB memory stick.

Searching files and musical resources

With Pa900, you can press the SEARCH button to search for files or musical resources.

How to use the Search function

Depending on the page you are in, you can search for different types of data. For example, while in Media mode you can only search for files, while in Style Play or Song Play mode you can search for several different types of data (Styles, Songs, Lyrics...).

There are some pages where the Search function is not available, since there are no relevant data to search for that page (for example, the pages of the Global mode).

Here is the general procedure.

- 1 Press the SEARCH button to open the Search window.

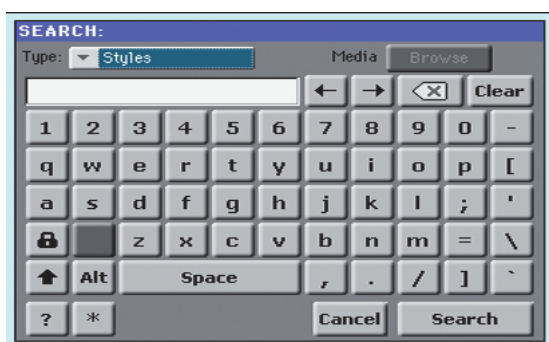

- 2 If needed, touch the "Type" pop-up menu, and choose the type of item you are looking for.

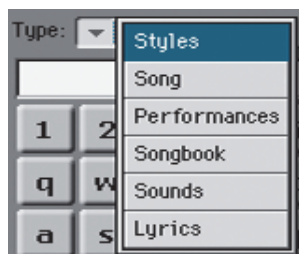

When choosing Files, Songs or Lyrics, the "Browse" button will be activated, to allow for searching files in the disks.



3 In case you are searching for a file in a disk, touch the “Browse” button to open the Media window.

When you see the folder containing the file you are looking for, touch it, then touch the Select button to close the Media window. The name of the selected folder will be shown in the title bar of the Search window.

Use the Device pop-up menu to select one of the available storage devices

Use the Open and Close buttons to browse through the folders

In case you are lost among the directories, touch the “Root” button to go to the root of the selected device

4 Type the name of the file to be searched.

There is no difference between upper and lower cases (“LOVE” is the same as “Love” or “love”).

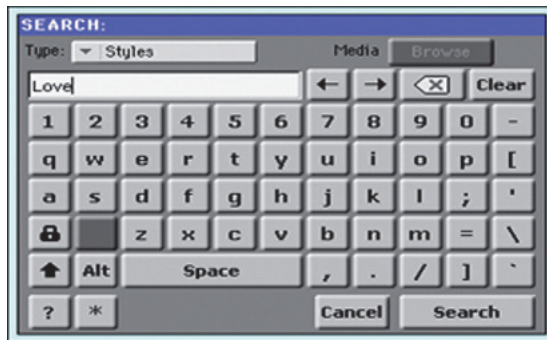

5 When finished entering the name, touch the “Search” button.

After a while, the list of files found begins to appear in the display.

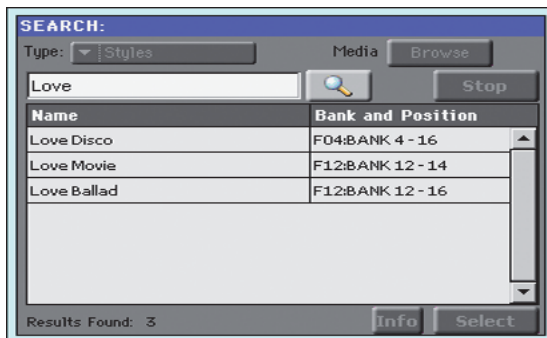

After you have touched the “Search” button, its name changes to “Stop”. If needed, touch this button to stop the ongoing search. The name of the button reverts to “Search”. Any file found will remain in the display, until you do a new search.

The time needed to complete a search depends on the size of the device(s) and the number of files.

Note: Only one search at a time can be carried on. Please wait for the current search to be completed, or touch the Stop button in the display to stop the current search and do a new one.

Hint: You can touch the Cancel button in the display, or press the EXIT button in the control panel, to exit from this window and carry on other operations. The search will continue in the background.

- 6** You can touch one of the found items to select it, and then touch the “Info” button to see information on it.

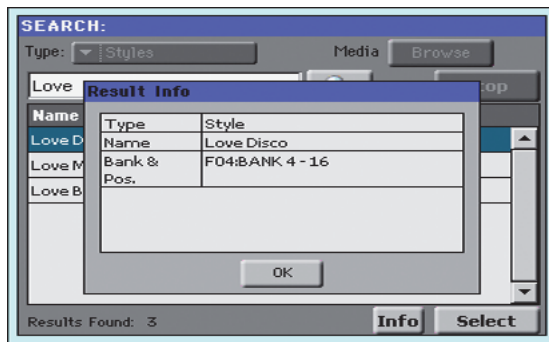

Touch OK to close the Info dialog box.

- 7** If you want to return to the main Search page and type a search string again, touch the



icon. *Otherwise,*

- 8** If you have found what you were looking for, touch its name and then touch the “Select” command.

- 9** You can exit from the Search window at any time, by pressing the EXIT or SEARCH button.

Notes about searching

Wildcards

During search, the string entered will be search as a whole word or as part of a word. For example, if you entered “love”, Pa900 will find “Love” and “LoveSong”, or any other word containing the string “love”.

You can use the wildcards “?” (any single character) and “*” (any sequence of characters) to search exactly that string. For example, “*love” will find “MyLove”, but not “LoveSong”. “??love” will find “MyLove” but not “TrueLove”.

Also, if you are looking for words that can be spelled in a slightly different way, you can use the “?” wildcard to find all occurrences; “gr?y” will find out both “gray” and “grey”.

Reference

Selecting elements

The following windows are shown in the various operating modes, whenever you try to select a Sound, Performance, Style or Song.

Style Select window

To open the Style Select window, touch the Style area whereas it appears in the display, or one of the buttons in the STYLE section on the control panel.

Press EXIT to exit from this page and go back to the previous page without selecting any Style.

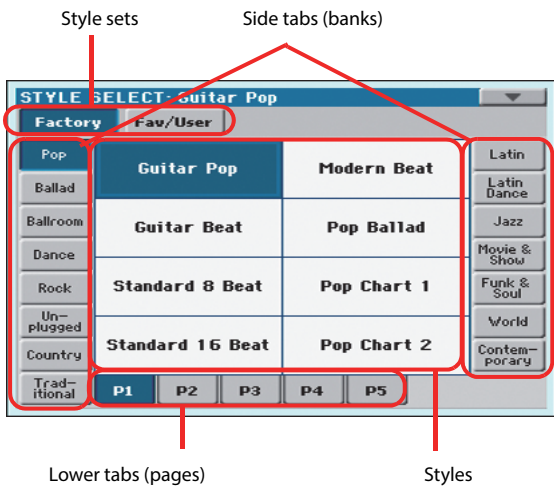

Note: Depending on the status of the “Auto Select” parameter (see page 248), a Style may be immediately selected when pressing one of the STYLE buttons. The latest selected Style for that bank will be selected.

Style sets

Selected set of Styles. **Factory** Styles are Styles supplied as standard. **Fav/User** are **Favorite** Styles (locations for custom-made Styles with editable names) and **User** Styles (locations for custom-made Styles with fixed names).

Side tabs (banks)

Use these tabs to select a bank of Styles. Favorite tabs can be renamed (see “Renaming the Favorite banks” on page 129).

Lower tabs (pages)

Use these tabs to select one of the available pages in the selected bank.

Styles

Touch one of these buttons in the display to select a Style. Unless the “Display Hold” parameter (see page 248) is turned on, the window automatically closes shortly after you select a Style.

After selecting a Style from this window, and another Style is playing, the name of the new Style name begins to flash, meaning it is ready to start playing at the beginning of the next measure.

Style Select page menu

Touch the page menu icon to open the menu. Touch a command to select it. Touch anywhere in the display to close the menu without selecting a command.

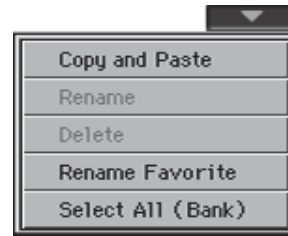

Copy and Paste

Use this command to copy the selected Style to a different selection,

1. Select the Style to be copied. To select more items, keep the SHIFT button pressed and touch all the item to be selected for copying. **Hint:** You can deselect one of the selected items by touching it while still keeping the SHIFT button pressed. You can deselect all by touching a single item.
2. Choose the Copy and Paste command.
3. Select the target location. In case you are copying more than a single item, all subsequent items will sequentially follow the first one. If there aren't enough locations available, the procedure will be cancelled. **Warning:** If you confirm, any Style already existing at the target location will be overwritten!

Rename

Use this command to edit the name of the selected item. Please keep in mind that you can only rename non-protected items.

1. Select the Style to be renamed,
2. Choose the Rename command, and use the virtual keyboard to edit the name.
3. When done, touch OK to confirm.

Delete

Choose this command to delete the selected item. Please keep in mind that you can only delete non-protected items.

1. Select the Style to be deleted. To select more items, keep the SHIFT button pressed and touch all the item to be selected for deleting. **Hint:** You can deselect one of the selected items by touching it while still keeping the SHIFT button pressed. You can deselect all by touching a single item.
2. Choose the Delete command, and confirm deletion. **Warning:** Unless you have a copy of it, the deleted item will be gone forever!

Rename Favorite

Choose this command to edit the name of the Favorite Style banks.



The assigned name can be spanned over two lines, by separating them with the paragraph character (¶). For example, to write “World Music” on two lines, enter “World¶Music”.

Be careful not to write words exceeding the width of the side tabs of the Style Select window.

1. Choose the Rename Favorite command.
2. Touch the **T** (Text Edit) symbol next to the bank to be renamed.
3. Use the virtual keyboard to edit the name.
4. When done, touch OK to confirm.

Select All (Bank)

Choose this command to select all items in the current bank.

You can deselect one of the selected items by touching it while keeping the SHIFT button pressed. You can select all by touching any single item.

Sound Select window

To open the Sound Select window, touch the Sound area whereas it appears in the display, or the SOUND SELECT button of the control panel.

Press EXIT to exit from this page and go back to the previous page without choosing any Sound.

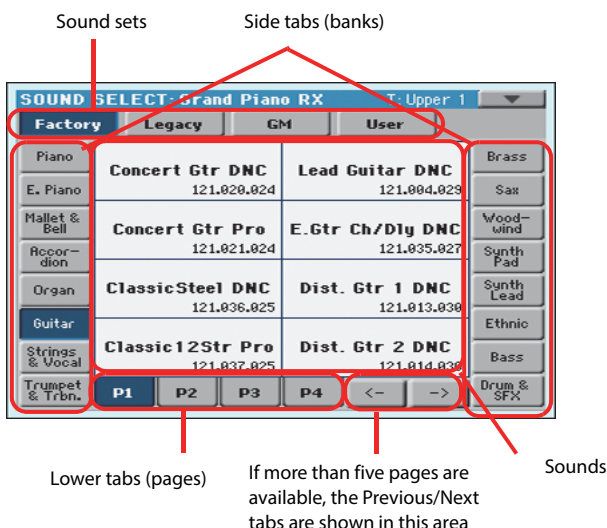

Sound sets

Selected set of Sounds. **Factory** Sounds are the Sounds supplied as standard. **Legacy** Sounds are Sounds compatible with older Pa-Series models. **GM** are Drum Kits mapped according to the General MIDI 2 or XG standards. **User** Sounds are custom-created or edited Sounds.

Side tabs (banks)

Use these tabs to select a bank of Sounds.

Lower tabs (pages)

Use these tabs to select one of the available pages in the selected bank.

Previous/Next tabs

Scroll the lower tabs to the left or the right, when additional tabs are available but cannot be seen in the display.

Sounds

Touch one of these buttons in the display to select a Sound. Unless the “Display Hold” parameter (see page 248) is turned on, the window automatically closes shortly after you select a Sound.

Program Change

Program Change number. Shown only when the “Show” parameter is turned on in Global mode. (See page 248).

Sound Select page menu

Touch the page menu icon to open the menu. Touch a command to select it. Touch anywhere in the display to close the menu without selecting a command.

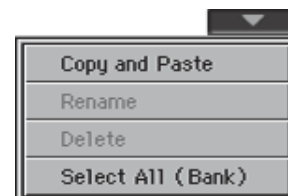

The commands are the same seen for the Style Select window’s page menu, apart for a difference with the Delete command.

Delete

Choose this command to delete the selected Sound.

1. Select the Sound to be deleted. To select more items, keep the SHIFT button pressed and touch all the item to be selected for deleting. **Hint:** You can deselect one of the selected items by touching it while still keeping the SHIFT button pressed. You can deselect all by touching a single item.
2. Choose the Delete command, and confirm deletion. **Warning:** Unless you have a copy of it, the deleted item will be gone forever!

Note: This command does not delete any User PCM Sample used by User Sounds. In case you need more free PCM Sample memory, and you know there are unused Samples and Multisamples in memory, use the “Not assigned to any Multisample/Drumkit” option of the “Delete” command in the Sampling mode to clean memory (see page 244).

Performance Select window

To open the Performance Select window, touch the Performance area whereas it appears in the display, or one of the PERFORMANCE buttons on the control panel. Use the PERFORMANCE buttons to go directly to the selected bank.

Press EXIT to exit from this page and go back to the previous page without selecting any Performance.

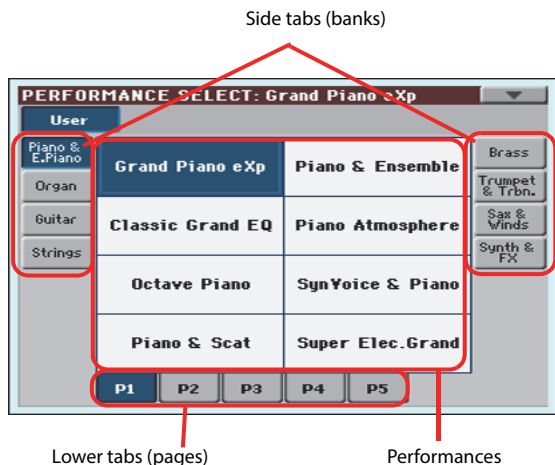

Note: Depending on the status of the “Auto Select” parameter (see page 248), a Performance may be immediately selected when pressing one of the PERFORMANCE buttons. The latest selected Performance for that bank will be selected.

Side tabs (banks)

Use these tabs to select a bank of Performance. Each tab corresponds to one of the PERFORMANCE buttons on the control panel.

Lower tabs (pages)

Use these tabs to select one of the available pages in the selected bank.

If you press again the same PERFORMANCE button on the control panel, the next page in the same bank is selected. This way, you do not need to touch one of the corresponding tabs in the display in order to select a different page.

Performances

Touch one of these buttons in the display to select a Performance. Unless the “Display Hold” parameter (see page 248) is turned on, the window automatically closes shortly after you select a Performance.

Performance Select page menu

Touch the page menu icon to open the menu. Touch a command to select it. Touch anywhere in the display to close the menu without selecting a command.

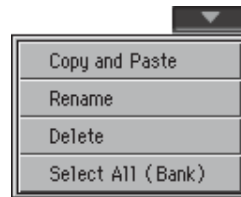

The commands are the same seen for the Style Select window’s page menu.

Pad Select window

Touch the Pad area whereas it appears in the display, to open the Pad Select window.

Press EXIT to exit from this page and go back to the previous page without selecting any Pad.

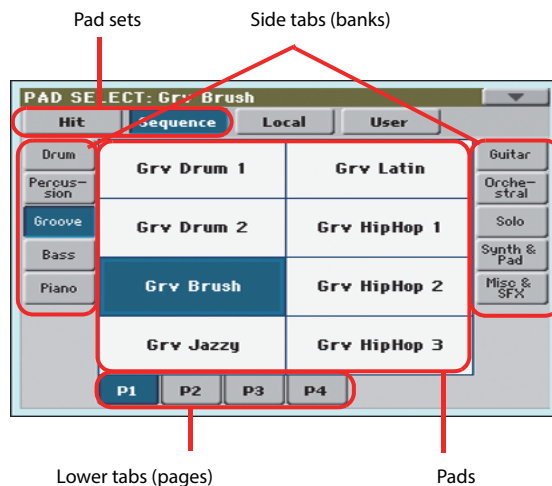

Pad sets

Selected set of Pads. **Hit** are single-note, pre-programmed factory Pads. **Sequence** are sequence-based, pre-programmed factory Pads. **Local** are like Factory Pads, but contain Pads customized for the music of your Country. **User** can be either single-note or sequence-based Pads, and can be user-created or modified.

Side tabs (banks)

Use these tabs to select a bank of Pads.

Lower tabs (pages)

Use these tabs to select one of the available pages in the selected bank.

Pad

Touch one of these buttons in the display to select a Pad. Unless the “Display Hold” parameter (see page 248) is turned on, the window automatically closes short after you select a Pad.

Pad Select page menu

Touch the page menu icon to open the menu. Touch a command to select it. Touch anywhere in the display to close the menu without selecting a command.

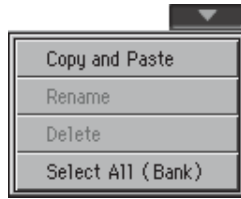

The commands are the same seen for the Style Select window's page menu.

STS Select

To select one of the four STS associated with the current Style or the selected SongBook Entry, use the four STS buttons on the control panel.

As an alternative, touch the STS name tab in the main page of the Style Play or Song Play mode, where you can see the name of the available STSs.

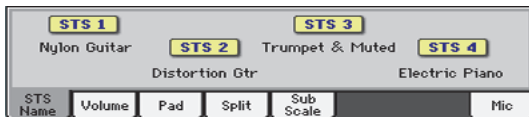

The STS's name can also be seen in the Lyrics and Markers page:



Song Select window

This page appears when you touch the Song name in the display, or press the SELECT button in one of the PLAYER sections on the control panel.

Press EXIT to exit from this page and go back to the main page of the Song Play operating mode without selecting a Song.

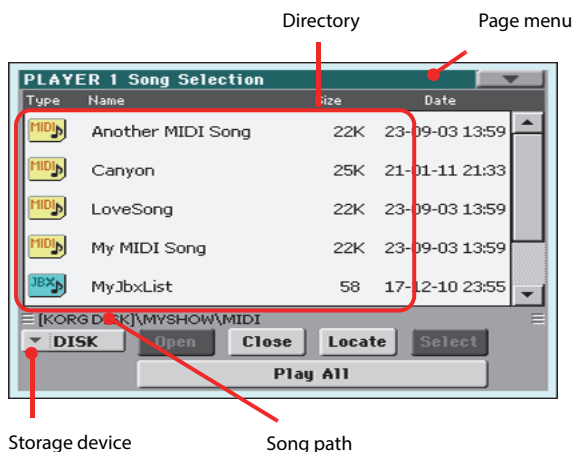

While in this page, you can select a Standard MIDI File, Karaoke, MP3 or Jukebox file.

Directory

This is the list of the selected device's content.

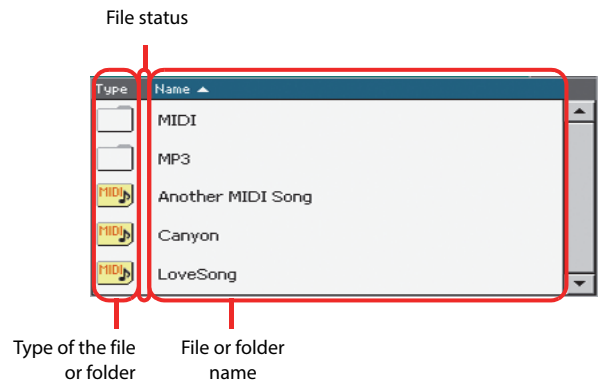

Use the scrollbar to scroll the list items. As an alternative, you can scroll the list using the VALUE dial.

When the Name label is selected on top of the list, keep the SHIFT button pressed and touch one of the arrows to jump to the previous or next alphabetical section.

You can touch one of the labels on top of the list, to reorder the list items accordingly. By touching the label again, the order of the files will switch between ascending and descending.

A list can contain several different types of files or folders.

Type icon	File/folder type
	Standard MIDI File (MID)
	Karaoke file (KAR)
	MPEG Layer 3 (MP3)
	Jukebox file (JBX)
	Folder

A file or folder may be in one of the following status. (See "Protect" and "Unprotect" on page 293 for information on how to change the file status).

Status icon	File/folder status
	Protected
-	Unprotected

Page menu icon

Touch the page menu icon to open the menu. See "Song Select page menu" on page 104 for more information.

Storage device

Use this menu to select one of the available storage devices.

Device	Type
USB	Optional device connected to the rear USB Host port

The actual name (label) of the device appears within square brackets ([]).

Song path

This line shows the current device path.

Open

Opens the selected folder (item whose icon looks like this one:



Close

Closes the current folder, returning to the parent (“upper”) folder.

Locate

Touch this button to go back to the folder containing the selected Song. This is useful to quickly locate it, after you have browsed through long directories and “dug” into different folders.

Select

Selects the highlighted item in the display. If a Song is already playing, it stops, and the new Song is ready to play. You will return to the main page.

Play All

When you touch this button, all Standard MIDI Files and MP3 files contained in the current directory are added to a new Jukebox list, that is automatically assigned to Player 1. The order in which they are played depends on the current sorting method, i.e., how the files are shown in the display.

You can use this Jukebox list as any other list of this type (i.e., start the playback with PLAY/STOP, jump to the next Song in the list with SHIFT + >>, edit it in the Jukebox page...).

Note: A Jukebox list can include up to 127 Songs. If your folder contains more items, only the first 127 will be considered.

Hint: If you don't want the list to be deleted when setting the instrument to standby, go to the Jukebox page and save it as a “JBX” file.

Selecting a Song by its ID number

Each Song in a folder on a device (up to 9,999) has a progressive ID number assigned. When the “Show Song Number” option is selected in the Song Select page menu (see below), you can see this number before the Song's name in the Song Select window. You can use this number to select the Song by composing the corresponding number, speeding up the Song retrieval when you are using a hard disk filled with midifiles.



While in the Song Select window, press the SELECT button in the corresponding PLAYER section to open the keypad, and enter the number corresponding to the Song to be selected.

While in any page of the Song Play mode, press the SELECT button in the corresponding PLAYER section twice to open the keypad.

Note: If no Song corresponds to the dialed number, the “Song not available” message will appear.

Note: While the directory may contain more than 9999 files, you can't select Songs outside the 0001-9999 range when using the numeric keypad.

Song Select page menu

Touch the page menu icon to open the menu. Touch a command to select it. Touch anywhere in the display to close the menu without selecting a command.

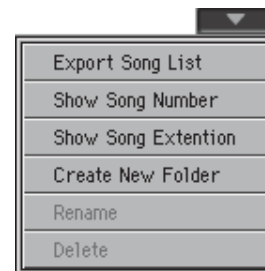

Export Song List

Select this command to save the current list as a text file. This way, you will be able to print a list of Songs, to see which number matches each Song.

1. While in the Song Select window, select the folder whose Song list you wish to save as a text file.
2. Select the Export Song List command from the page menu.
3. A dialog box will appear, asking you to select one of the available storage devices.

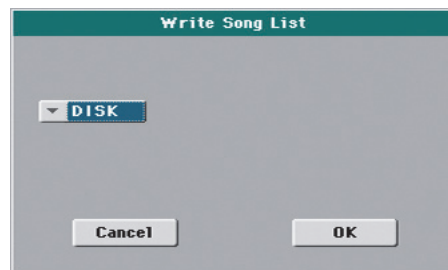

4. Select one of the options, and touch OK to confirm.

Note: The text file will contain a list of “*.mid”, “*.kar”, “*.mp3” and “*.jbx” files only. Folders and other types of files will not be included.

When saved, the text file will be named after the selected folder. For example, a folder named “Dummy” will generate a “Dummy.txt” file. If a file with the same name already exists in the target, it will be overwritten without waiting for any confirmation. A file containing the list of all valid files contained into the root of the disk will generate a “Root.txt” file.

The list will include the progressive number assigned to each Song, the file names, the total number of files in the list.

To correctly display and print the list on a personal computer, use a fixed size (i.e., non-proportional) character in your text editor.

Show Song Number

Check this option to make the Song's progressive ID number appear in the list, next to each Song.

Show Song Extension

Check this option to make the file extension (*.mid, *.kar, *.jbx, *.mp3) appear in the list, at the end of each Song's name.

Create New Folder

This command will let you create a new generic folder in the root of any device, or inside any other generic folder. You can't create a ".SET" folder with this command, since this type of folder is reserved to the Save operations (and can be created with the New SET button in any Save page).



By touching the **T** (Text Edit) button you can open the Text Edit window. Enter the name, then touch OK to confirm and close the Text Edit window.

Rename

(Only available when an item is selected in a list) Use this function to change the name of an existing file or folder. You cannot change the 3-character extension of files and ".SET" folders, since they are used to identify the type of file or folder.

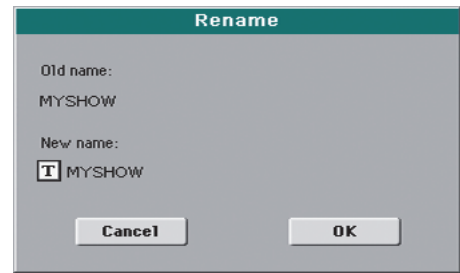

Touch the **T** (Text Edit) button to open the Text Edit window. Enter the new name, then touch OK to confirm and close the Text Edit window.

Delete

(Only available when an item is selected in a list) Use this command to delete the selected file or folder.

Style Play mode

The Style Play mode is the boot-up operating mode. When in this mode, you can play along with the Styles (i.e. automatic accompaniments), using up to four tracks (Upper 1-3 and Lower) to play on the keyboard. You can choose different Sounds and Effects by selecting Performances and STSs. Four Pads will provide single-shot sounds or repeating patterns in sync with the Style. You can also use the SongBook to automatically select Styles suited for a particular song.

Start-up settings

Since the “My Setting” Performance is automatically selected when turning the instrument on, you can save your preferred start-up settings to it.

Select the Sounds, Effects, and other settings you would like to see automatically selected when turning the instrument on. Then keep the MY SETTING button pressed for about one second. When the Write Startup Settings window appears, confirm by touching OK.

Note: If you like some settings to be preserved even when choosing different Performances, STSs and Styles, turn on the desired “locks” to avoid changes to the selected parameters (see “General Controls: Lock” on page 249).

How Styles, Variations, Performances and STSs are linked together

Styles, Variations, Performances and STSs are linked in many ways.

- When the STS MODE LED is steadily on or blinking, selecting a Style also changes the Keyboard tracks (STS 1 is automatically selected). Performance settings are overridden.
- When the STS MODE LED is blinking, selecting a Variation also select the corresponding STS.
- When the STYLE CHANGE LED is on, selecting a Performance also selects a Style (the one memorized with the Performance).
- Current track settings can be saved either to a Performance, an STS, or the Style Settings, depending on the Write command you select.

Styles and Pads

Each Style includes four Pads. Each time you select a Style, the four Pads it contains are assigned to the four PAD buttons. The Style and the Pads will play using the same Tempo value.

Master Volume and Balance

While the MASTER VOLUME knob controls the general volume of the instrument, you can use the BALANCE knob to balance the Style’s Accompaniment and Pad tracks against the Keyboard tracks.

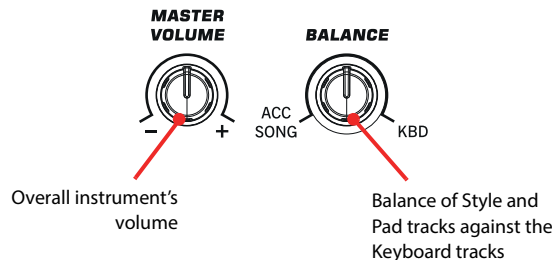

Note: As an alternative, the BALANCE knob can also work as a volume control. See “Balance Slider” on page 255.

Factory, Favorite and User Styles

There are three different types of Style locations:

- Factory Style banks are the preloaded Styles, that you can’t usually edit (unless you want to do so by turning off the protection, see “Factory Style and Pad Protect” on page 254).
- Favorite Style banks are Styles that can be loaded from an external device, or can be created or edited in Style Record mode. You can rename the tabs in the Style Select window to create places for custom banks, or for additional music genres that are not already included among the supplied banks. See “The Favorite banks” on page 129 for information on how to manage these Styles.
- User Style banks are, like the Favorite banks, Styles loaded from an external device, created or edited by yourself (the User). These are banks conceived as a ‘workbench’ – a place where to manage Styles and banks before saving them to a final location. See the “Style/Pad Record mode” chapter for information on how to edit or create Styles.

Main page

This is the page you see when you turn the instrument on.

To access this page from another operating mode, press the STYLE PLAY button.

To return to this page from one of the Style Play edit pages, press the EXIT button.

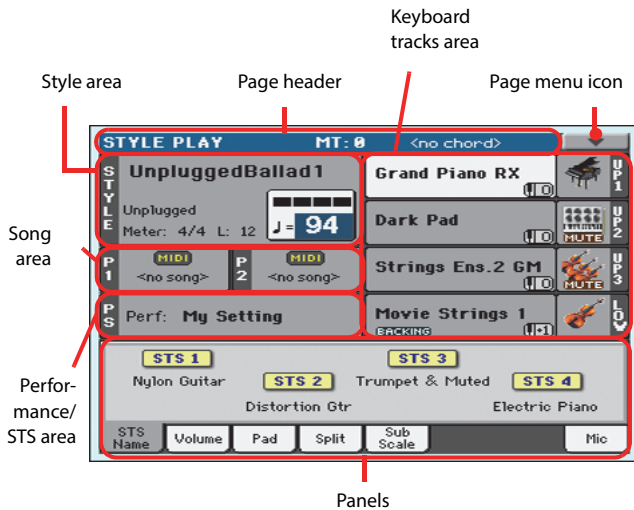

Details on individual tracks can be seen by pressing the Volume tab. Use the TRACK SELECT button to switch between Normal view (Keyboard tracks, grouped Style tracks) and Style view (individual Style tracks). (See “Volume panel” starting from page 109).

Page header

This line shows the current operating mode, transposition and recognized chord.

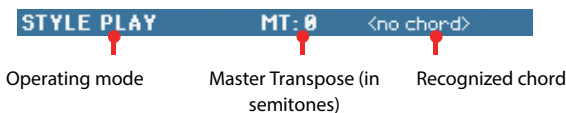

Operating mode name

Name of the current operating mode.

Master transpose

Master transpose value in semitones. This value can be changed by using the TRANSPOSE buttons on the control panel.

Note: Transpose may automatically change when selecting a different Performance or Style. It may also change when loading a Standard MIDI File generated with an instrument of the Korg Pa-Series.

To avoid transposition, the Master Transpose is “locked” by default. If you want to unlock it, change the Master Transpose Lock parameter’s status (see “General Controls: Lock” on page 249).

Recognized chord

Displays the recognized chord, when you play a chord on the keyboard. If no chord abbreviation is shown, check if at least one of the LEDs in the CHORD SCAN section is turned on.

You can choose how chords are recognized by using the CHORD SCAN buttons and the “Chord Recognition” parameter in the Global > Style page (see page 252).

Page menu icon

Touch the page menu icon to open the menu. See “Page menu” on page 127 for more information.

Style area

This is where the Style name is shown, together with its Tempo and Meter (Time Signature) parameters.

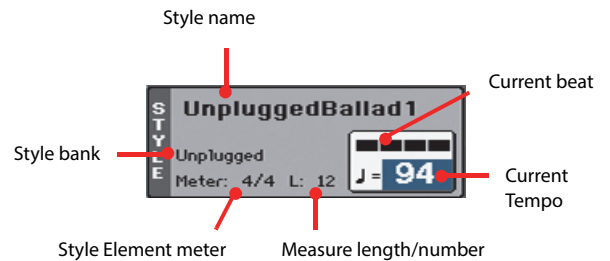

Style name

Currently selected Style. Touch the Style name (or press one of the buttons in the STYLE section) to open the Style Select window.

Style bank

Bank the current Style belongs to.

Style Element meter

Meter (time signature) of the current Style Element.

Measure length/number

While the Style is playing, an ‘M’ appears, to show the current measure number of the current Style Element playing. While it is in stop, an ‘L’ appears, to show the length (total number of measures) of the current Style Element.

Current beat

Beat number currently playing.

Current Tempo

Metronome Tempo (from 30 to 250). Use the TEMPO buttons to change the Tempo value.

As an alternative, keep the SHIFT button pressed and use the VALUE DIAL to change the Tempo. Also, you can touch the Tempo field and drag it with your finger, or change it with the VALUE DIAL.

To recall the Tempo stored in the current Style, press the TEMPO buttons together.

You can prevent Tempo from changing by turning the TEMPO LOCK LED on.

Note: Since Style Elements may contain Tempo Change data, Tempo may change while a Style Element is playing.

Songs area

This is where the Songs assigned to the onboard Players are shown.

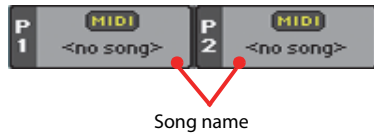

Song name

Name of the Songs assigned to the Players. You can select Songs while playing Styles, to have them ready when switching to Song Play mode.

Performance/STS area

This is where the latest selected Performance or STS name is shown.

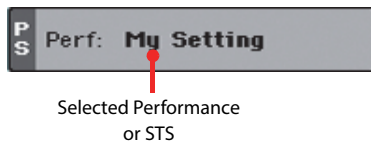

Selected Performance or STS

This is the latest selected Performance (Perf) or Single Touch Setting (STS#).

Touch the name to open the Performance Select window (see "Performance Select window" on page 102). As an alternative, use the PERFORMANCE section to select a different Performance.

To select a different STS, use the four STS buttons under the display, or the STS panel in the display.

Keyboard tracks area

This is where Keyboard tracks are shown.

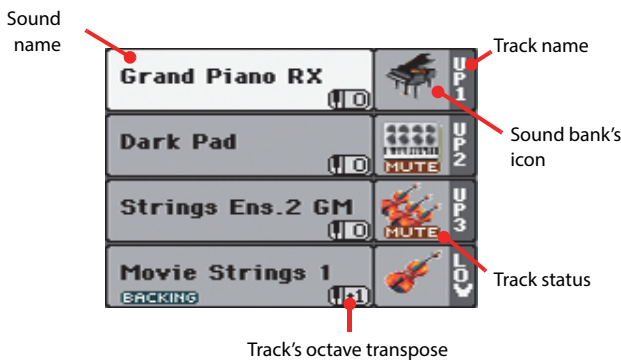

Sound name

Name of the Sound assigned to the corresponding Keyboard track.

- If the track is already selected (white background), touch the Sound name to open the Sound Select window.
- If the track is not selected (dark background), first select it, then touch the Sound name to open the Sound Select window.

You can also open the Sound Select window by using the SOUND SELECT button on the control panel.

For more information about the Sound Select window, see "Sound Select window" on page 101.

Keyboard track octave transpose

Non editable. Octave transpose of the corresponding track. To individually edit the octave transpose for each track, go to the "Mixer/Tuning: Tuning" edit page (see page 116).

You can also transpose all Upper tracks by using the UPPER OCTAVE buttons on the control panel.

Bass & Lower Backing icon

When the Bass & Lower Backing function is active, the Backing icon appears in the Lower track Sound area (see "Bass & Lower Backing" on page 253).



Keyboard track name

Non editable. Name of the corresponding track:

Abbreviation	Track	Hand
UP1	Upper 1	Right hand (or both when in Full Keyboard mode)
UP2	Upper 2	
UP3	Upper 3	
LOW	Lower	Left hand

Sound bank's icon

This picture illustrates the bank the current Sound belongs to.

Keyboard track status

Play/mute status of the current track. Select the track, then touch this area to change the track status.

No icon Play status. The track can be heard.



Mute status. The track cannot be heard.

Panels

The lower half of the main page contains the various panels, you can select by touching the corresponding tabs. See more information in the relevant sections, starting from page 109.

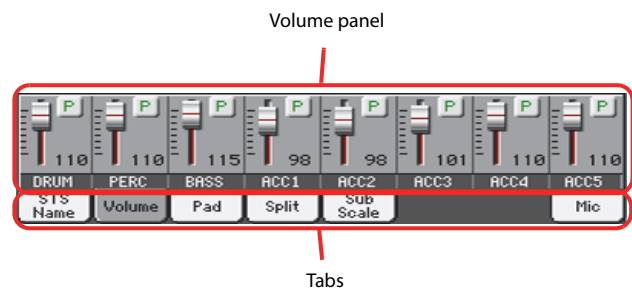

STS Name panel

Touch the STS Name tab to select this panel. Single Touch Settings (STS) are memory locations intended for quickly choosing Keyboard Sounds, contained in each Style or SongBook Entry. While in this panel, you can see the name of the four STSs belonging to the latest selected Style or SongBook Entry. Touch one of the names to select the corresponding STS.



Note: You cannot edit the STS names in this panel. To edit a name, select the STS to be renamed, then select the Write Single Touch Setting command from the page menu (see “Write Single Touch Setting dialog box” on page 128).

Volume panel

Touch the Volume tab to select this panel. This is where you can set the volume of each track, and mute/unmute them.

Changing the tracks' volume

You can change the volume of each track by dragging the sliders in the display. You can also change the volume by touching a track's slider, then using the VALUE DIAL.

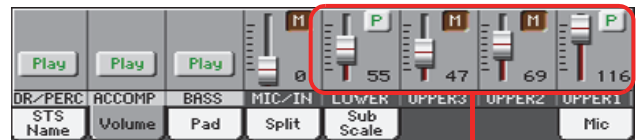

Sliders

Changing the Play/Mute status

Play/mute status of the current track. Select the track, then touch this area to change its status.

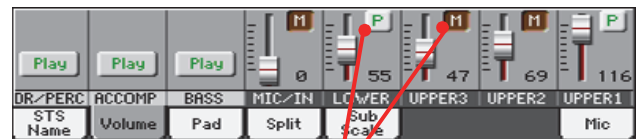

Track status icons



Play status. The track can be heard.



Mute status. The track cannot be heard.

Saving the track's volume and play/mute status

Each set of tracks can be saved into a different memory. This allows for a great flexibility when mixing Keyboard and Accompaniment tracks through the use of Performances, STSs and Styles.

- The volume and play/mute status of the **Keyboard tracks** can be saved to a Performance or STS (see “Write Performance” on page 127 and “Write Single Touch Setting” on page 127).
- The volume and play/mute status of the **separate Style tracks** can be saved to the current Style Settings (see “Write Current Style Settings” on page 127).
- The offset volume of the **grouped Style tracks** is automatically saved to the Global.

Track names

Under the sliders, a label for each track is shown. Use the TRACK SELECT button to switch between the

TRK SELECT



Normal (grouped Style tracks, Keyboard tracks) and the **Style Tracks** view (separate Style tracks).

Track	Description
Normal View	
DR/PERC (*)	Grouped Drum and Percussion tracks.
ACCOMP (*)	Grouped Accompaniment tracks (Acc1-5).
BASS (*)	Grouped Bass Style track.
LOWER	Lower track.
UPPER1...3	Upper tracks.
Style Tracks View	
DRUM	Drum Style track.
PERC	Percussion Style track.
BASS	Bass Style track.
ACC1...5	Accompaniment Style tracks.

(*).Volume for these grouped tracks is a global offset, that can be adjusted in the Global > Mode Preferences > Style page.

Normal view

In **Normal view** you can see the grouped Style tracks (Play/Mute only), and the separate controls for the Keyboard tracks:

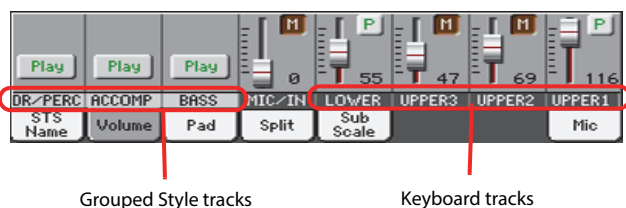

Grouped Style tracks

Keyboard tracks

Grouped Style tracks

In the Normal view, Style tracks are grouped together (Dr/Perc, Accomp, Bass groups), to allow for instant play/mute of several tracks at the same time.

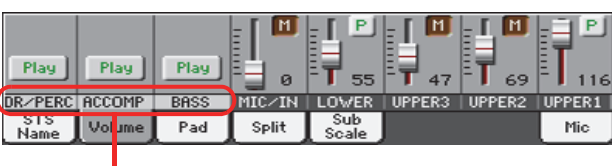

Grouped Style Tracks

Changing the volume of the grouped Style tracks can be done (as a general control) in the Global mode > Mode Preferences > Style page (see “Style Tracks Global Volume” on page 253).

Keyboard tracks

Here you can separately control the volume and play/mute status of each Keyboard track.

Style Tracks view

Press the TRACK SELECT button to switch from the Normal view to the **Style Tracks view**. In this view, individual Style tracks are shown in the lower half of the display, while the upper half of the main page changes to show parameters for the selected Style track.

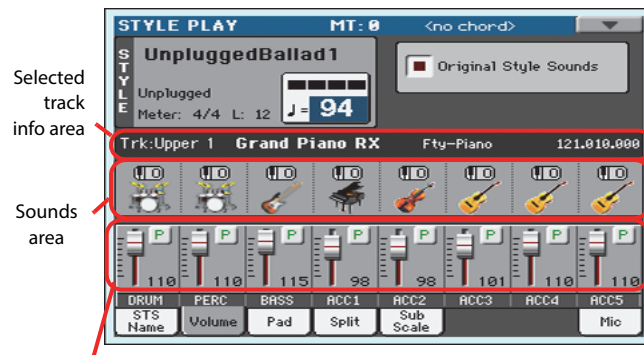

Selected track info area

Sounds area

Style tracks Volume

Press TRACK SELECT again to return to the Normal view (Keyboard tracks, grouped Style tracks, Mic/In controls).

Style tracks Volume

Here you can change the volume and play/mute status of each one of the individual Style tracks.

Original Style Sounds

This parameter lets you decide if the Style has to play the Sounds saved in the Performance or Style Settings, or the ones saved in each Style Element.

Note: When assigning a Sound to a Style track, the “Original Style Sounds” parameter is automatically turned off to allow its use.

Note: This parameter can be saved with the Performance or Style Settings.

On Style tracks always use the original Sounds recorded inside each Style Element. If you assign a different Sound to a Style track, this parameter is automatically set to Off.

Off You can assign different Sounds to each Style track, and save them in a Performance or Style Settings. The selected Sounds remain the same for all Style Elements. These Sounds can be saved into a Performance or Style Settings with the “Write Performance” or “Write Current Style Settings” commands (see page 127). Assigned Sounds are shown in the Sounds area of this page.

Selected Track Info area

This line lets you see the Sound assigned to the selected track. It appears both in the main page, and in several edit pages.

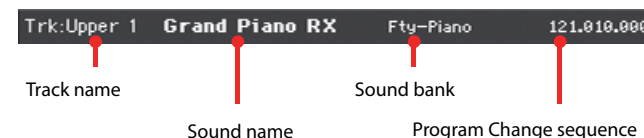

Track name

Sound name

Sound bank

Program Change sequence

Track name

Name of the selected track.

Sound name

Sound assigned to the selected track. Touch anywhere in this area to open the Sound Select window, and select a different Sound.

Sound bank

Bank of the selected Sound.

Program Change

Program Change number sequence (Bank Select MSB, Bank Select LSB, Program Change).

Sounds area

This area lets you see the Sound bank's icon and octave transposition for the eight Style tracks.

Style track's octave transpose icon



Sound bank's icon

Style track's octave transpose icon

Non editable. Octave transpose of the corresponding track. To change the octave transpose, use the UPPER OCTAVE buttons, or go to the "Mixer/Tuning: Tuning" edit page (see page 116).

Sound bank's icon

This picture illustrates the bank the current Sound belongs to. Touch an icon a first time to select the corresponding track (detailed information are shown on the Selected Track Info area, see above). Touch it a second time to open the Sound Select window.

Pad panel

Touch the Pad tab to select this panel. This is where you can assign a different Hit or Sequence Pad to each of the four pads, and see at a glance how pads are programmed. For more options, go to the "Pad/Switch: Pad" page (see page 125).

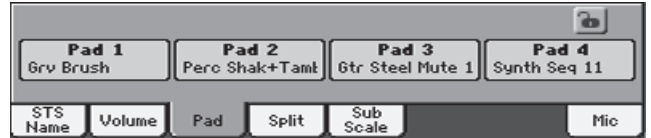

Pad assignment

Name of the Hit or Sequence assigned to each Pad. Touch the box to make the Pad Select window appear (see "Pad Select window" on page 102).

When the lock is open, Pads could automatically change when choosing a Style or SongBook Entry.

Pads lock icon (🔒)

Close this lock to prevent Pads from changing when choosing a different Style or SongBook Entry.

Split panel

Touch the Split tab to select this panel. This is where you can set the split point and activate the Bass Inversion.

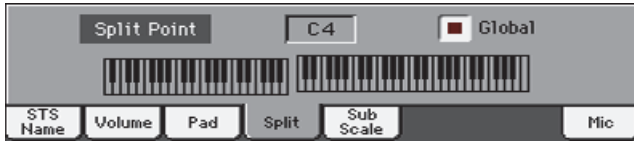

Split Point

Use this parameter to select a different split point. A full-range piano keyboard is shown in the display, divided at the selected split point. Upper tracks play on the right of this point, while the Lower track plays on the left.

Keyboard diagram

Touch anywhere on the keyboard diagram. A message will appear, asking you to press the new split point on the keyboard of your Pa900 (or to press the EXIT button to close the message with no changes).

Global

There is a global split point, and a “local” one, that can be memorized into the Performances and STSs.

- On You are editing the global split point. The global split point is considered when selecting a Performance or STS that does not contain a “local” split point.
- Off You are editing the “local” split point memorized in the current Performance or STS.

Sub-Scale panel

Touch the Sub-Scale tab to select this panel. This panel replicates the “Mixer/Tuning: Sub Scale” edit page (see page 117).

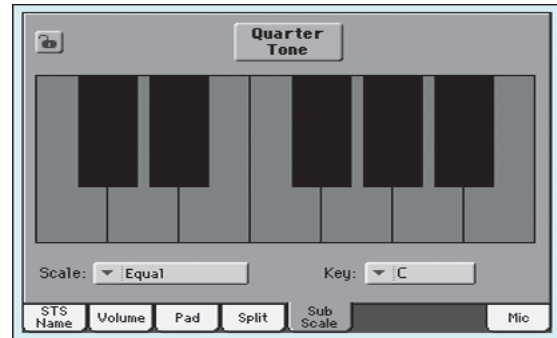

With the “Quarter Tone” button not pressed

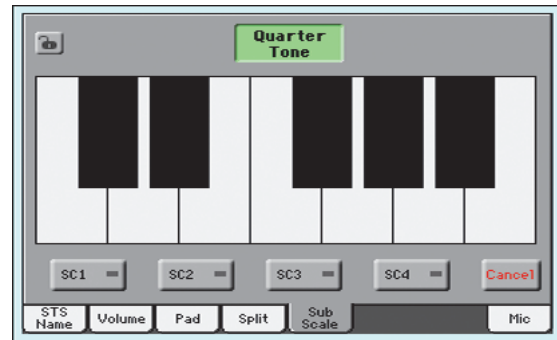

With the “Quarter Tone” button pressed

Mic panel

Touch the Mic tab to select this panel. This is where you can set the various Voice Processor options.



Note: Depending on the audio input routing, the microphone input might not work, whichever the status of the switches in this page. See “Audio & Video: Audio In” on page 264.

VP Preset

Use this pop-up menu to select one of the available Voice Processor Presets. Selecting a Preset may change all the Voice Processor parameters. Presets can be freely edited (see “Mic: Preset” on page 265).

Global

You can choose a global VP Preset, and a “local” one, that can be memorized into a Performance, STS or SongBook Entry.

On You are choosing the global VP Preset, that will be considered when selecting a Performance, STS or SongBook Entry that does not contain a “local” split point.

Off You are choosing the “local” VP Preset memorized in the current Performance, STS or SongBook Entry.

Mic Talk On/Off

Use this switch to soften all music generated by the Pa900, and speak in the microphone at normal level. This is useful to address your audience, while automatically lowering the background music volume.

On While this switch is pressed, all the Voice Processor modules are momentarily turned off. The Talk function can be programmed in the Talk section of the Global > Mic > Global Setup page (see “Mic: Global Setup” on page 454).

Off Release this switch to return to the original settings.

Harmony Level

Use this knob to adjust the level of the Harmony voices. By default, this control is assigned to the ASSIGNABLE KNOB.

EQ (Low / Mid / Hi)

Use these knobs to adjust the level of the corresponding Equalization bands. The Equalizer has effect on the Lead voice only.

Edit menu

From any page, press the MENU button to open the Style Play edit menu. This menu gives access to the various Style Play edit sections.

When in the menu, select an edit section, or press EXIT or STYLE PLAY to exit the menu and return to the main page. To return to the main page, you can also select the Main Page menu item.

When in an edit page, press EXIT or the STYLE PLAY button to return to the main page of the Style Play operating mode.

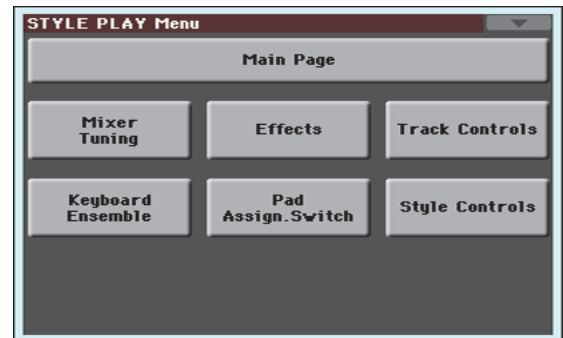

Each item in this menu corresponds to an edit section. Each edit section groups various edit pages, that may be selected by touching the corresponding tab on the lower part of the display.

Edit page structure

All edit pages share some basic elements.

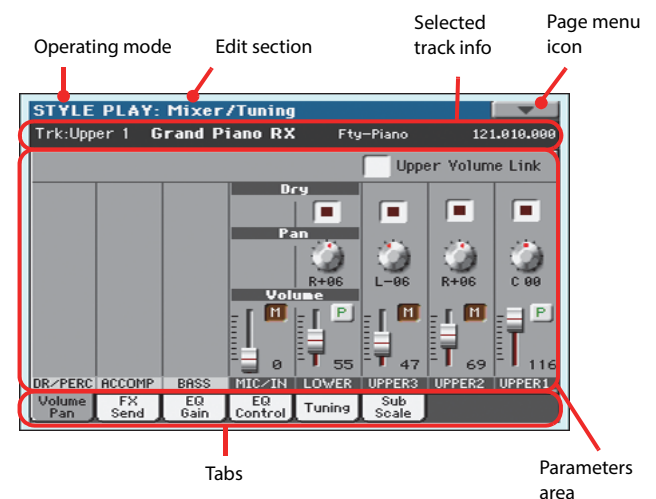

Operating mode

This indicates that the instrument is in Style Play mode.

Edit section

This identifies the current edit section, corresponding to one of the items of the edit menu (see “Edit menu” on page 113).

Page menu icon

Touch this icon to open the page menu (see “Page menu” on page 127).

Parameters area

Each page contains various parameters. Use the tabs to select one of the available pages. For detailed information on the various types of parameters, see sections starting below.

Tabs

Use tabs to select one of the edit pages of the current edit section.

Mixer/Tuning: Volume/Pan

This page lets you set the volume and pan for each of the Keyboard or Style tracks. Volume settings are the same as in the Volume panel of the main page.

Use the TRACK SELECT button to switch from the Keyboard to the Style tracks, and vice versa.

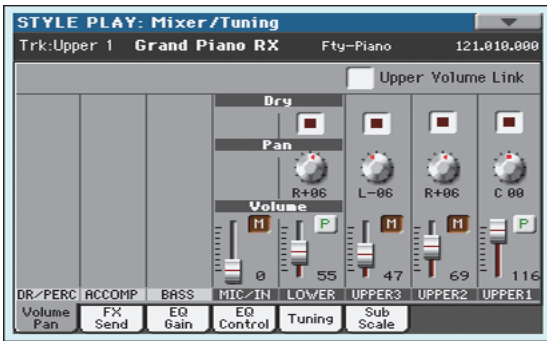

Upper Volume Link

With this parameter, you define if changing the volume of one of the Upper tracks proportionally changes the volume of the other Upper tracks.

- On When changing the volume of one of the Upper tracks, volume for the other Upper tracks changes proportionally.
- Off When changing the volume of one of the Upper tracks, only that track's volume is changed. The other Upper tracks are left unchanged.

Dry

Use this checkbox to turn the dry (direct) track signal on or off from the outputs.

- On When checked, the direct signal coming from the track is sent to the output, mixed with the Master FXs.

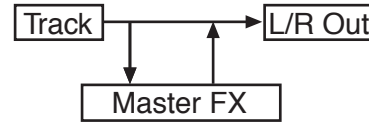

- Off When unchecked, the direct signal coming from the track is removed from the audio output, and only sent to the Master FXs. The effected signal will still be panned (in stereo FXs only) according to the Pan value.

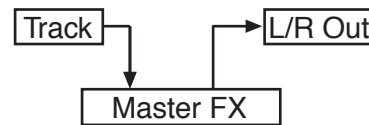

Pan

Track position in the stereo field.

- L-64...L-1 Left stereo channel.
- C 00 Center.
- R+1...R+63 Right stereo channel.

Volume

Track's volume. This is the volume of each track, as saved in the Style (Style Settings), Performance or STS. It may change when choosing a different Style, Performance or STS.

- 0...127 MIDI value of the track's volume.

Play/Mute icon

Track's play/mute status.



Play status. The track can be heard.



Mute status. The track cannot be heard.

Mixer/Tuning: FX Send

Pa900 includes two groups of effects (FX A and FX B). While in Style Play mode, the A group is reserved to the Style and Pad tracks, the B group to the Keyboard tracks.

Choosing and editing the effects is done in the dedicated Effect section (see “Effects: A/B FX Configuration” on page 119).

This page lets you set the level of the track’s signal going to the Master FX processors. The Master FX processors are connected in parallel with the dry/direct signal, so you can decide the amount of direct signal that will be sent to the Master FX processors.

In case you do not want to hear the direct signal, just set the Dry parameter to Off (see “Dry” above).

You can assign to the Master FXs any kind of available effects, but we found it convenient to arrange them in the following way, for most of the Styles, STS and Performances included with the Pa900:

- A-Master 1 Reverb processor for the Style and Pad tracks.
- A-Master 2 Modulating FX processor for the Style and Pad tracks.
- B-Master 1 Reverb processor for the Keyboard tracks.
- B-Master 2 Modulating FX processor for the Keyboard tracks.

Use the TRACK SELECT button to switch from Keyboard to Style tracks, and vice-versa.

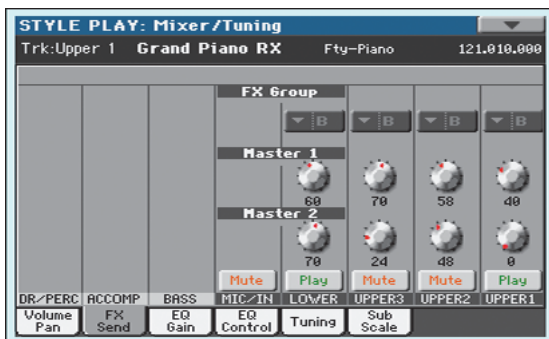

FX Group



This indicates the FX group (A or B) assigned to the group of tracks shown.

Send level (Master 1, Master 2)

0...127 Level of the track (direct) signal sent to the corresponding Master FX effect processor.

Play/Mute icon

Track’s play/mute status.

-  Play status. The track can be heard.
-  Mute status. The track cannot be heard.

Mixer/Tuning: EQ Gain

In this page you can set the three-band equalization (EQ) for each individual track.

Use the TRACK SELECT button to switch from the Keyboard to the Style tracks, and vice-versa.

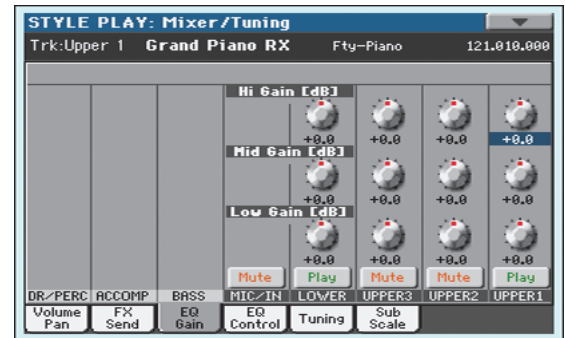

Hi (High) Gain

This parameter lets you adjust the high frequencies equalization on each individual track. This is a shelving curve filter. Values are shown in decibels (dB).

-18...+18dB High gain value in decibels.

Mid (Middle) Gain

This parameter lets you adjust the middle frequencies equalization on each individual track. This is a bell curve filter. Values are shown in decibels (dB).

-18...+18dB Middle gain value in decibels.



Low Gain

This parameter lets you adjust the low frequencies equalization on each individual track. This is a shelving curve filter. Values are shown in decibels (dB).

-18...+18dB Low gain value in decibels.

Play/Mute icon

Track’s play/mute status.

-  Play status. The track can be heard.
-  Mute status. The track cannot be heard.

Mixer/Tuning: EQ Control

This page lets you reset or bypass the track's equalization, programmed in the previous page.

Use the TRACK SELECT button to switch from the Keyboard to the Style tracks, and vice-versa.

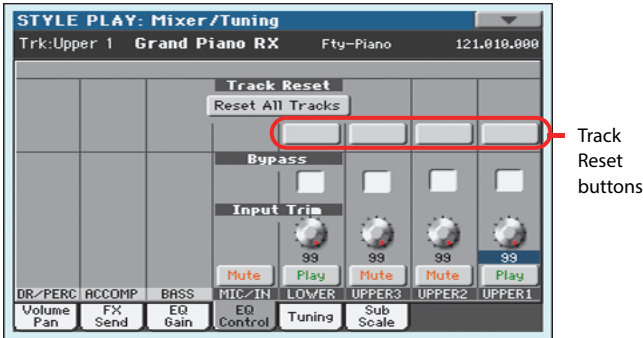

Track Reset buttons

Reset All Tracks button

Touch this button to reset (i.e., “flatten”) equalization for all tracks (both Realtime and Style tracks).

Track Reset buttons

Use these buttons to reset (i.e., “flatten”) equalization for the corresponding track.

Bypass

Check any of these checkboxes to bypass the equalization for the corresponding track. When bypassed, equalization has no effect on the track, but all parameters are preserved. When the box is unchecked, equalization is activated again.

On The bypass function is engaged, so no equalization is active on the corresponding track.

Off The bypass function is not engaged, so the equalization is active on the corresponding track.

Input Trim

This knob allows you to limit the level of the signal passing through the equalizer. Extreme equalization values can overload the audio circuits and lead to distortion. This control lets you set equalization as desired, and at the same time avoid overloading.

0...99 Limiting value. The higher, the most effective it is.

Play/Mute icon

Track's play/mute status.

 Play status. The track can be heard.

 Mute status. The track cannot be heard.

Mixer/Tuning: Tuning

This page is where you can set the octave transpose and fine tuning for each track. Plus, you can program the Pitch Bend range for each track.

Use the TRACK SELECT button to switch from the Keyboard to the Style tracks, and vice-versa.



PB Sensitivity

These parameters show the Pitch Bend range for each track, in semitones.

1...12 Maximum up/down pitch bend range (in semitones). 12 = ±1 octave.

0 No pitch bend allowed.

Oct(ave) Transpose

This is the octave transpose value.

-3 Lowest octave.

0 Standard tuning.

+3 Highest octave.

Detune

This is the fine tuning value.

-64 Lowest pitch.

00 Standard tuning.

+63 Highest pitch.

Play/Mute icon

Track's play/mute status.

 Play status. The track can be heard.

 Mute status. The track cannot be heard.

Mixer/Tuning: Sub Scale

You can assign a different scale (a sub-scale) to the Keyboard tracks, the Upper tracks or all tracks. This will allow, for example, to play a solo with a particular Quarter Tone tuning, while the backing tracks play in the Equal tuning.

This page is where you can program the sub-scale for the selected tracks; a different sub-scale can be associated to each Performance or STS. Track selection is general, and can be done with the “Scale Mode” parameter of the Global > Mode Preferences > Style page (see page 252).

The remaining tracks will use the basic scale set in the Global > Tuning > Scale page (see “Main Scale” on page 257). This is the “standard” scale of the instrument.

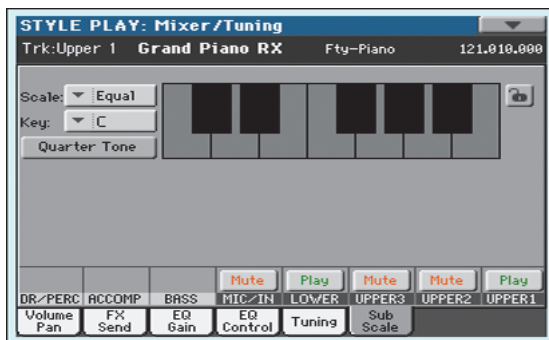

With the “Quarter Tone” button not pressed

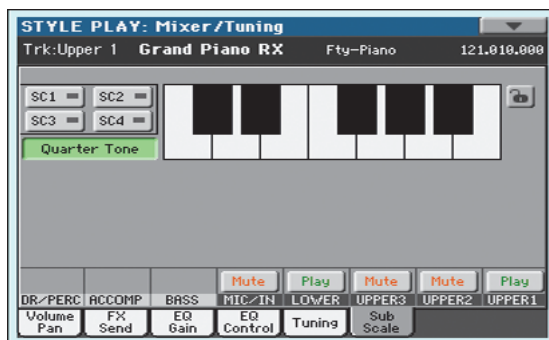

With the “Quarter Tone” button pressed

Note: Quarter Tone selection can be received via MIDI (i.e., from an external sequencer or controller). Conversely, selection of Quarter Tone settings can be sent by the Pa900 to an external MIDI recorder as System Exclusive data.

Scale

Selected scale. See “Scales” on page 356 for a list of the available scales. When selecting the User scale, the keyboard diagram becomes active, letting you program a custom scale (see “How to create a custom scale by fine-tuning each note of the User scale” below).

Key

This parameter is needed by some scales to set the preferred key (see “Scales” on page 356).

Quarter Tone

Press the Quarter Tone button in the display to make the keyboard diagram active. In the display, touch any note you want to lower a quarter tone, making a big dot appear on the note diagram. Touch the note again to make the dot disappear.

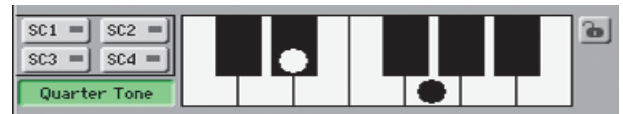

Touch one of the four SC Preset buttons to recall the corresponding preset, and touch any note you want to lower a quarter tone down, making a big dot appear on the detuned note in the diagram. Touch the note again to make the dot disappear.

Scale alteration made in this page is momentary and is not memorised. It is only meant to allow for fast scale alteration while playing.

To make realtime changes faster, you can also assign the Quarter Tone function to the footswitch or an Assignable Switch (see below “How to use the Quarter Tone function with a footswitch or Assignable Switch” for more information).

The use of SC Presets allows for immediate recall of previously programmed Quarter Tone scales (see below “How to use the Quarter Tone function with the SC Presets” for more information).

SC Preset buttons

These buttons only appear when the “Quarter Tone” parameter is checked. Use these buttons to recall the corresponding custom scale presets. See “How to use the Quarter Tone function with the SC Presets” below for information on how to use them.

Keyboard diagram

When “Quarter Tone” is checked, this diagram allows for lowering each note of a quarter tone. When a User scale is selected, it allows you to fine-tune each note’s pitch.

Scale lock icon

When locked, Scale parameters remain unchanged when selecting a different Performance or STS.

For more information on parameter locks, see “General Controls: Lock” on page 249.

How to create a custom scale by fine-tuning each note of the User scale

When the User scale is selected, the keyboard diagram becomes active. You can then change each note tuning in cents of a semi-tone (within a range of ± 99 cents, referred to Equal tuning). This way, you can create a custom scale, that you can save to a Performance or STS.

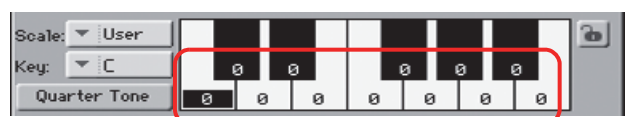

Fine tuning values

After having selected the User scale, touch a note in the keyboard diagram, and use VALUE DIAL to adjust the selected note tuning in cents.

Note: These settings can be saved to a Performance or STS, as described below.

How to use the Quarter Tone function with the SC Presets

When the “Quarter Tone” button is pressed, four “SC Preset” buttons appear, and you can select one of four SC Presets to recall a preset custom scale.

1. Program and save a custom scale into an SC Preset.

To do so, go to the Global mode, and reach the “Tuning: Scale” page. When programming is done, choose the “Write SC Preset” command from the page menu, then select one of the preset locations where to save the current settings (see “Write Quarter Tone SC Preset dialog box” on page 275).

2. Return to this page, and touch the “Quarter Tone” button to make the “SC Preset” buttons appear.
3. Touch one of the “SC Preset” buttons to recall a preset custom scale.

Each preset contains custom detuning of each note of the scale, and memorizes the selected degree(s) of the scale.

When no preset is selected, the default scale is automatically recalled. This scale assigns a -50 cent value to all notes, and turns all scale degrees off.

You can also select an SC Preset by assigning the relevant function to an Assignable Switch (see “Pad/Switch: Switch” on page 125) or Assignable Footswitch (see “Controllers: Foot Controllers” on page 255).

4. Use the keyboard diagram to turn the note detuning on or off.
Make a big dot appear to detune the corresponding note, or make it disappear to reset tuning.
5. Reset the original scale.
Touch the “Quarter Tone” button again, to deselect it and recall the main scale.

How to use the Quarter Tone function with a footswitch or Assignable Switch

You can assign the “Quarter Tone” function to a footswitch or an Assignable Switch, to program a custom scale in realtime, for example to allow for those sudden scale changes typical of the Arabic music. These changes are not saved anywhere, so the scale is easily “wiped-out” when selecting a different Performance or STS, or when pressing the Quarter Tone pedal again.

Note: While in Style Play mode, you can create a custom scale, to be assigned to a Performance or STS, simply by selecting and editing a User scale, and saving any change to a Performance or STS. See “How to create a custom scale by fine-tuning each note of the User scale” above.

While in Global mode, you can create a custom scale and save it to one of the four SC Presets, and recall it by touching one of the SC Preset buttons in the display. Then, you can start your realtime scale editing from the selected preset. See “How to use the Quarter Tone function with the SC Presets” above.

1. Program the footswitch or an Assignable Switch to be the Quarter Tone switch.

Simply go to the Global mode, and reach the “Controllers: Foot Controllers” page. There, you will find the “Pedal/Footswitch” parameter, to which you can assign the Quarter Tone function.

2. Lower some note pitches.

Keep the Quarter Tone pedal pressed. The keyboard will not play at this time. Press the notes you want to lower a quarter tone. Release the pedal.

3. Play with your new scale.

Notes you pressed on step 2 are now lowered of a quarter tone.

4. Reset the original scale.

Press and release the Quarter Tone pedal again, without playing any note. All pitches will be reset, and the scale selected by the Performance or STS will be recalled.

Effects: A/B FX Configuration

This page allows you to select the A (Style and Pads) and B (Keyboard) groups of effects. Please use the “FX A” and “FX B” side tabs to switch from one group to the other one.

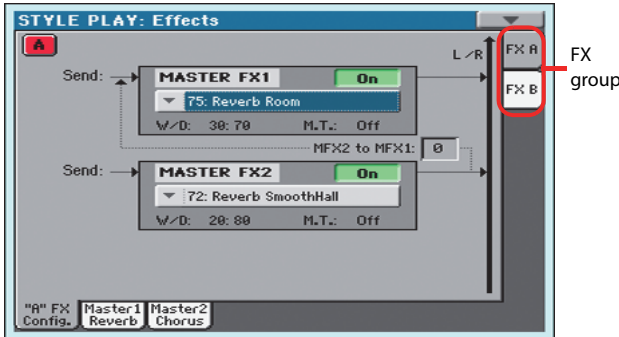

FX Groups (FX A, FX B)

Pa900 includes two groups of effects (FX A and FX B). There are two master FXs for group. In Style Play mode, the A group is reserved to the Style and Pad tracks, the B group to the Realtime (Keyboard) tracks.

Master FX 1, 2

Effects assigned to the corresponding effect processors. Usually, FX1 are reverbs, while FX2 are modulating effects (chorus, flanger, delay...). For a list of the available effects, see in the Appendix.

Effects assigned to both FX groups can be saved to a Performance. Effect assigned to the FX A group (Style and Pad tracks) can be saved to the Style Settings. Effects assigned to the FX B group (Keyboard tracks) can be saved to an STS.

W/D

Use this parameter to set the amount of the effect (Wet) against the non-effected (Dry) signal coming from the track.

MF2 to MF1

Amount of the MF2 effect going back to the input of the MF1 effect.

M.T. (Modulating Track)

Source track for modulating MIDI messages. You can modulate an effect parameter with a MIDI message generated by an internal physical controller.

Effects: Master 1, 2

These pages contain the editing parameters for the four effect processors. Here is an example of the FX A page, with the Reverb Wet Plate effect assigned.

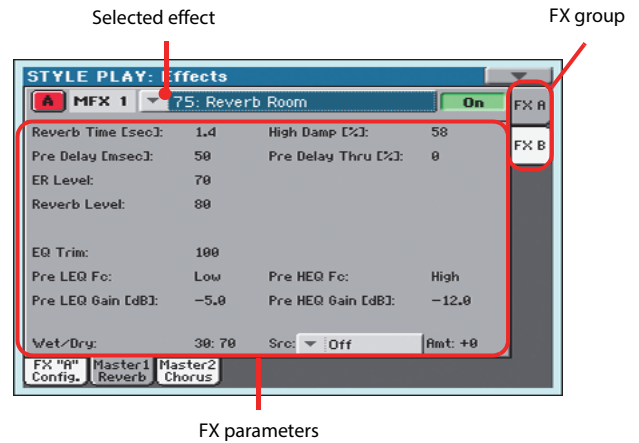

Selected effect

Select one of the available effects from this pop-up menu.

FX parameters

Parameters may be different, depending on the selected effect. See the relevant chapter in the Appendix for a list of the available parameters for each effect type.

Wet/Dry

Use this parameter to set the amount of the effect (Wet) against the non-effected (Dry) signal coming from the track.

Src (Source)

Modulation source. To select the track generating this message, see the “M.T. (Modulating Track)” parameters found in the “Effects: A/B FX Configuration” page (see above). See the relevant chapter in the Appendix for a list of the modulation sources.

Track Controls: Mode

This page lets you connect each track to the internal sound generator and to external MIDI devices. This is very useful to let a Style track drive an external expander, or play a digital piano with one of Pa900's Keyboard tracks. In addition, here you can set the polyphony mode for each track.

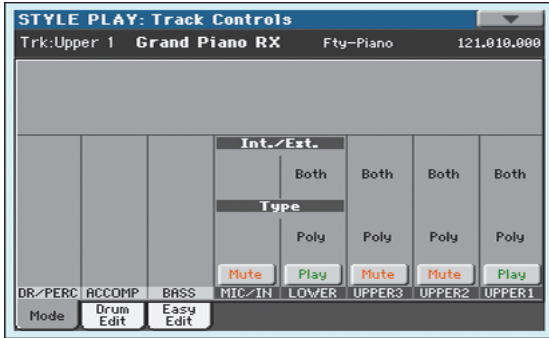

Int./Ext. (Internal/External)

Internal The track plays the sounds generated by the internal sound engine. It does not play an external instrument connected to the MIDI OUT.

External The track plays an external instrument connected to the MIDI OUT. The connected device must receive on the MIDI channel associated with this track on the Pa900 (see "MIDI: MIDI Out Channels" on page 261).

A track set to this status cannot play the internal sounds.

Instead of the assigned Sound name, the <E: aaa.bbb.ccc> indicator is shown on a track's area in the Main page:



Control Change/Program Change area

This indicator begins with a remark saying the track is in External ("E") mode, and continues with a strings of transmitted Control Change and Program Change data. This will let you know what the track is transmitting to the MIDI OUT. In the following example, **CC#0** is the Control Change 0 (Bank Select MSB), **CC#32** is the Control Change 32 (Bank Select LSB), **PC** is the Program Change:



When touching the Sound area, the numeric keypad appears, instead of the Sound Select window. You can enter the Control Change/Program Change bundle shown above, separating the three parts with a dot (.).

Both The track plays both the internal sounds and an external instrument connected to the MIDI OUT.

Type

Drum Drum/Percussion track. Set a track to Drum mode if you wish to separately adjust the volume and set a different output for each percussive family of the assigned Drum Kit Sound. (See "Track Controls: Drum Edit" on page 121).

Note: Tracks set to Drum or Percussion mode while in Style Record (see "Track Type" on page 156) cannot be edited here. This option appears in grey. Other Style tracks cannot be set to Drum mode here.

Note: Drum Kits are not affected by transpose whichever the type of track they are assigned to.

Hint: Set a track to Drum mode, if you don't want the assigned Sound to be transposed (it will behave as a Drum Kit).

Poly Tracks of this kind are polyphonic, i.e. they can play more than one note at the same time.

Mono Tracks of this kind are monophonic, i.e. each new note stops the previous note.

Mono Right A Mono track, but with priority assigned to the rightmost (highest) note.

Mono Left A Mono track, but with priority assigned to the leftmost (lowest) note.

Play/Mute icon

Track's play/mute status.



Play status. The track can be heard.



Mute status. The track cannot be heard.

Track Controls: Drum Edit

In this page you can adjust the volume and edit the main parameters for each *family* of Drum and Percussion instrument for the selected track. A list of families is shown below.

These parameters can be accessed only on tracks set to the Drum mode (see above). Use them on tracks with a Drum Kit assigned, or you will not be able to hear any change.

Hint: Use the **TRACK SELECT** button to cycle between the track groups. After selecting a track, choose the “Solo Track” command from the page menu to avoid listening to the other tracks during editing.

Note: All values are offsets referred to the value of the original Sounds.



Family Select

Use these icons/buttons to select the drum family you want to edit. These buttons are only accessible when you select a Drum track.

Drum family icon	Drum family
	Kick drums
	Snare drums
	Toms
	Hi-Hat cymbals
	Ride, Crash and other cymbals
	Low-pitched percussions
	High-pitched percussions
	Special effects

Overview of the current parameter

Under the icons of the Drum families you can see the value of the selected parameter for all the families. This will let you compare the value of the selected family with all the others. The values are shown in grey (non editable).

Drum Edit parameters

Use these parameters to adjust the offset value.

Sound parameters	Meaning
Volume	Instrument's Volume.
EQ Hi	Equalization, High band.
EQ Mid	Equalization, Middle band.
EQ Low	Equalization, Low band.
Attack	Attack time. This is the time during which the sound goes from zero (at the moment when you strike a key) to it's maximum level.
Decay	Decay time. Time to go from the final Attack level to the minimum level.
Cutoff	Filter cutoff. This sets the sound brightness.
Resonance	Use the Filter Resonance to boost the cutoff frequency.
Fine Tune	Fine instrument tuning.
Coarse Tune	Coarse instrument tuning.
MFX 1 Send	Scales the Send level to the Master FX1.
MFX 2 Send	Scales the Send level to the Master FX2.

0...127 Volume (see above).

-64...0...+63 Offset value for all sound generation parameters. '0' means no change to the original value memorized in the Drum or Percussive instrument, while any other value means a decrease or increase to the original value.

Select

Use these buttons to select the track to edit. The button corresponding to the selected track turns green.

Reset Family

Touch this button to reset all changes to the selected family.

Reset Track

Touch this button to reset all changes to percussive instrument volumes in the selected track.

Play/Mute icon

Track's play/mute status.

Play status. The track can be heard.

Mute status. The track cannot be heard.

How to edit a single Drum Family

Here is a quick example of the use of the Drum Volume function.

1. While in this page, press **TRACK SELECT** to see individual Style tracks.
2. Touch the “Select” button, in the display, corresponding to the Drum track to edit.
3. Press **START/STOP** to let the Style go.
4. If you like, choose the “Solo Track” command from the page menu to solo the Drum track.

- While listening to the Style, select the Snare family, then select the Volume parameter, and use the VALUE DIAL to turn the volume completely off.

You'll notice how all snares stops sounding.

- Touch the Reset Track button in the display to recall the original Snare's volume.

Track Controls: Easy Edit

In this page you can edit the main parameters of the Sounds assigned to each track.

Hint: Use the TRACK SELECT button to cycle between the track groups. After selecting a track, choose the "Solo Track" command from the page menu to avoid listening to the other tracks during editing.

Note: All values are offsets referred to the value of the original Sound.

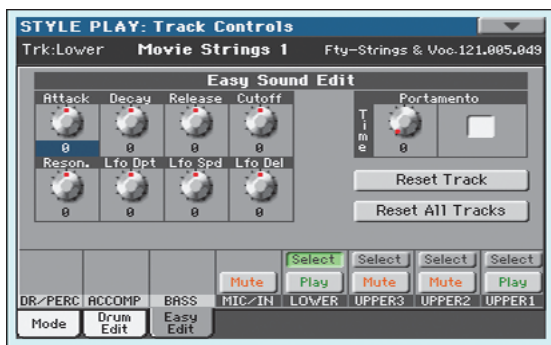

Easy Sound Edit parameters

Use these knobs to adjust the offset value.

Sound parameters	Meaning
Attack	Attack time. This is the time during which the sound goes from zero (at the moment when you strike a key) to it's maximum level.
Decay	Decay time. Time to go from the final Attack level to the beginning of the Sustain.
Release	Release time. This is the time during which the sound goes from the sustaining phase, to zero. The Release is triggered by releasing a key.
Cutoff	Filter cutoff. This sets the sound brightness.
Resonance	Use the Filter Resonance to boost the cutoff frequency.
LFO Depth	Intensity of the Vibrato (LFO).
LFO Speed	Speed of the Vibrato (LFO).
LFO Delay	Delay time before the Vibrato (LFO) begins, after the sound starts.

-64...0...+63 Offset value. '0' means no change to the original value memorized in the Sound, while any other value means a decrease or increase to the original value.

Portamento knob and switch

Use the Time knob to adjust the speed of the portamento (a slide between notes). Check the box to turn portamento on, or uncheck it to turn portamento off.

Select

Use these buttons to select the track to edit. The button corresponding to the selected track turns green.

Reset Track

Touch this button to reset all changes to Sound parameters in the selected track.

Reset All Tracks

Touch this button to reset all changes to Sound parameters in all tracks.

Play/Mute icon

Track's play/mute status.



Play status. The track can be heard.



Mute status. The track cannot be heard.

How to adjust sound parameters for a single Sound

Here is a quick example of the use of the Easy Sound Edit function.

- If needed, while in this page press TRACK SELECT to see Keyboard tracks.
- Touch the "Select" button, in the display, corresponding to the Upper 1 track.
- While playing on the keyboard to hear the Sound, select the Cutoff knob, and use the VALUE DIAL to turn its value completely off.

You'll notice how the filter progressively cuts out high frequencies, making the sound darker and mellower.

- Touch the Reset Track button in the display to recall the original Cutoff value.

Keyboard/Ensemble: Key/Velocity Range

This page lets you program a key and dynamic (velocity) range for each of the Keyboard tracks.

Key range is useful to create a set of Keyboard tracks playing in different zones of the keyboard. For example, you may have French Horns and Woodwinds playing in the center range of the keyboard, while only Woodwinds play on the higher range.

Velocity range is useful to create a sound made of up to three dynamic layers, assigning each of the Upper tracks to a different dynamic range.

As an example, you may assign the El.Piano 1 Sound to the Upper 1, and the El.Piano 2 Sound to the Upper 2 track. Then, set Upper 1 to [Bottom=0, Top=80], and Upper 2 to [Bottom=81, Top=127]. The El.Piano 1 will play when playing softer, the El.Piano 2 when playing louder.

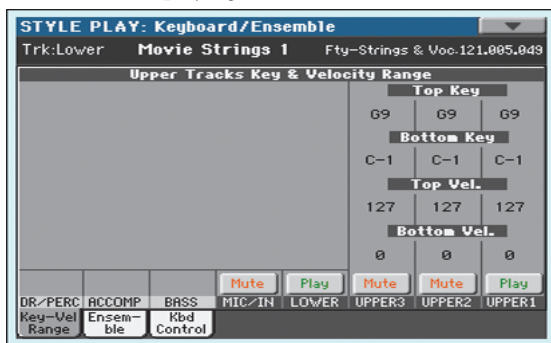

Top/Bottom Key (Key Range)

This parameter pair sets the Top and Bottom key range for the track.

C-1...G9 Selected key.

Top/Bottom Vel. (Velocity Range)

This parameter pair sets the Top and Bottom dynamic range for the track.

0 Lowest velocity value.

127 Highest velocity value.

Play/Mute icon

Track's play/mute status.



Play status. The track can be heard.



Mute status. The track cannot be heard.

Keyboard/Ensemble: Ensemble

This page lets you program the Ensemble function. This function harmonizes the right-hand melody (played in realtime) using the recognized chords played by the left hand.

The Ensemble works both in the Style Play and the Song Play modes. Chords are always recognized in the Lower Chord Scan area.

Note: The Ensemble function only works when the keyboard is in Split mode.

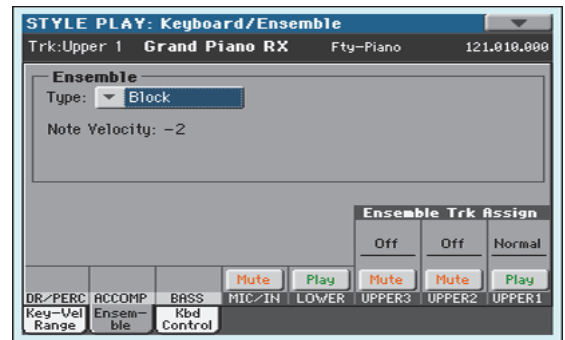

Ensemble

Harmonization type.

- Duet Adds a single note to the melody.
- Close Adds a closed-position chord to the melody.
- Open 1 Adds an open-position chord to the melody.
- Open 2 As the above, but with a different algorithm.
- Block Block harmonization – very typical of jazz music.
- Power Ensemble Adds a fifth and an octave to the melody, as heard in hard rock.
- Third Up This option adds a third over the melody note (depending on the recognized chord).
- Fourths LO Typical of jazz, this option adds two perfect fourths under the melody.
- Fourths UP As the above, but with notes added over the melody.
- Fifths This adds two fifths below the original note.
- Octave Adds an octave to the melody.
- Dual This option adds to the melody line a second note, at a fixed interval set with the “Note” parameter. When selecting this option, a transposition value appears (-24...+24 semitones to the original note).
- Brass Typical Brass section harmonization.
- Reed Typical Reed section harmonization.

- Trill** When two notes are played on the keyboard, this option trills them. If three or more notes are played, only the last two are trilled. You can set the trill speed by using the Tempo parameter (see below).
- Repeat** The played note is repeated in sync with the Tempo parameter (see below). When playing a chord, only the last note is repeated.
- Echo** As the Repeat option, but with the repeated notes fading away after the time set with the Feedback parameter (see below).
- AutoSplit1** If more than a single Upper track is in play, the Upper 1 track plays the melody in mono, while the other Upper tracks play the chord notes.
- If only the Upper 1 track is in play, it plays polyphonically all the chord notes.
- AutoSplit2** Similar to AutoSplit1, but the Upper 1 track always plays the uppermost note.

Note Velocity

This parameter sets the velocity difference between the right-hand melody and the added harmonization notes.

-10...0 Subtracted velocity value.

Tempo

Note: This parameter only appears when the Trill, Repeat or Echo options are selected.

Note value for the Trill, Repeat or Echo Ensemble options. This is in sync with the Metronome Tempo.

Feedback

Note: This parameter only appears when the Echo option is selected.

This parameter sets how many times the original note/chord is repeated by the Echo option.

Ensemble Track Assign

Use these parameters to separately set Upper tracks for the Ensemble function.

- Off** There is no harmonization on this track.
- Normal** This track is included in the harmonization.
- Mute** This track only plays the Ensemble notes, but not the original note.

Play/Mute icon

Track's play/mute status.

 Play status. The track can be heard.

 Mute status. The track cannot be heard.

Keyboard/Ensemble: Keyboard Control

This page lets you enable/disable the Damper and Expression pedals, plus the Joystick, for each of the Upper Keyboard tracks.

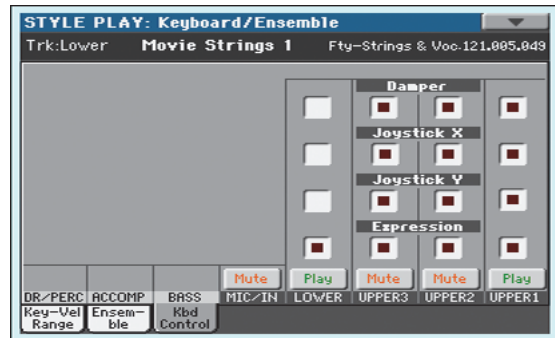

Damper

On When you press the Damper pedal and release the keys, the track's sound is kept sustained.

Off The Damper pedal is not active on any track set to this status.

Joystick X

This enables/disables the left/right movement of the Joystick (Pitch Bend, and sometimes a Sound parameter's control; for Pitch Bend settings, see "Mixer/Tuning: Tuning" on page 116).

Joystick Y

This enables/disables the front/rear movement of the Joystick (Y+: Modulation, and sometimes a different Sound parameter's control; Y-: Various controls, or non-active).

Expression

This parameter allows you to switch the Expression control on/off on each individual Keyboard track. The Expression control is a relative level control, always subtracted from the Volume value of the track.

As an example, imagine you have a Piano sound assigned to Upper 1, and a Strings sound assigned to Upper 2. If you turn the Expression switch on on Upper 2, and off on Upper 1, you can use a continuous pedal to control only the Strings' volume, while the Piano remains unchanged.

To program a pedal or Assignable Slider to act as an Expression control, see "Controllers: Foot Controllers" on page 255. You can only assign this function to a volume-type pedal, not to a switch-type one. Assign the "KB Expression" option to the pedal or Assignable Slider.

Play/Mute icon

Track's play/mute status.

 Play status. The track can be heard.

 Mute status. The track cannot be heard.

Pad/Switch: Pad

This page lets you select a different hit sound or sequence for each of the four PAD buttons.

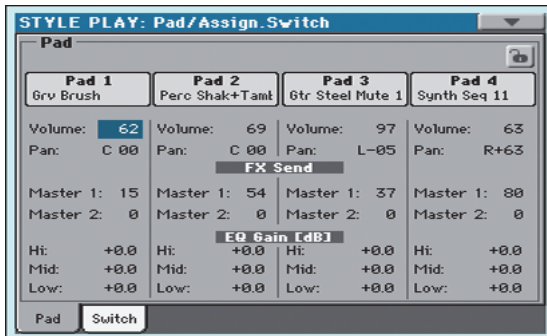

Assignments can be saved into the current Style Settings or SongBook Entry.

Note: Each Style or SongBook Entry can change the Pad assignment.

Pad assignment

Name of the Hit or Sequence assigned to each Pad. Touch the box to make the Pad Select window appear (see “Pad Select window” on page 102).

Note: You can also choose Hits or Sequences from the Pad panel of the main page.

Volume

Volume for each of the four Pad tracks.

0...127 Volume level.

Pan

Pan for each of the four Pad tracks.

-64...-1 Left stereo channel.

0 Center.

+1...+63 Right stereo channel.

FX Send (Master 1, 2)

Send level to the Master FX processors for each of the four Pad tracks. The Pads share the FX A group with the Style tracks.

0...127 Level of the Pad track (direct) signal sent to the effect processor.

EQ Gain [dB] (Hi, Mid, Low)

Equalization for each of the four Pad tracks.

-18.0...+0.0...18.0

Gain value of the High, Middle, or Low band.

Pad lock icon

This lock avoids selecting a different Style or SongBook Entry changes also the Hit or Sequence Pads assigned to the Pads.

For more information on parameter locks, see “General Controls: Lock” on page 249.

Pad/Switch: Switch

This page lets you select a different function for each of the ASSIGNABLE SWITCH buttons.



Assignable Switches can be saved into a Performance, STS or SongBook Entry.

Switch 1, 2, 3

Each of the ASSIGNABLE SWITCH buttons. Use these pop-up menus to assign a function to each switch. See “List of Assignable Switches functions” on page 356.

Assignable Switch lock icon

This lock avoids selecting a different Performance or STS changes also the functions assigned to the switches.

For more information on parameter locks, see “General Controls: Lock” on page 249.

Style Controls: Drum/Fill

In this page you can select various general parameters for the Style.

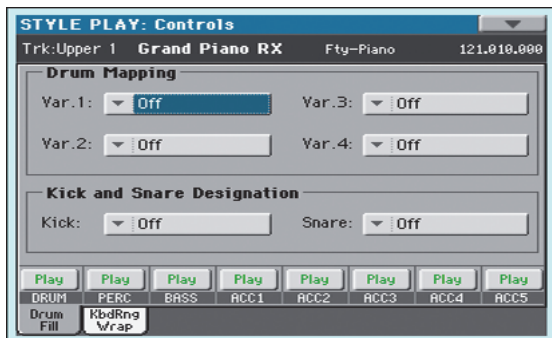

Drum Mapping (Var.1...Var.4)

The Drum Mapping lets you select an alternative arrangement of percussive instruments for the selected Drum Kit, without any additional programming. Just select a Drum Map, and some percussive instruments will be replaced with different instruments.

Off Standard mapping.

Drum Mapping 1...7

Drum Map number. Mapping 1 is “soft-sounding”, while mapping 7 is “loud-sounding”.

Kick and Snare Designation

The Kick Designation replaces the original Kick (Bass Drum) sound with a different Kick of the same Drum Kit, while the Snare Designation replaces the original Snare Drum sound with a different Snare of the same Drum Kit.

Hint: Select different Designations while listening to the Style, and see how they affect the Style. When you like the result, save your setting to a Performance or Style Settings.

Off Original Kick or Snare.

Type 1...3 Kick or Snare replacing the original one.

Track status

Track play/mute status. Touch these icons to change it.

 Play status. The track can be heard.

 Mute status. The track cannot be heard.

Style Controls: Keyboard Range On/Off / Wrap Around

In this page you can program the Wrap Around point, and turn on/off the Keyboard Range included in each Style tracks.



Keyboard Range On/Off

This parameter is an on/off switch for the Key Range parameter memorized inside each Style Element track.

On The Keyboard Range is considered – provided it has been programmed (see “Style Element Track Controls: Keyboard Range” on page 154 in Style Record mode). When a track goes over the lower or higher Keyboard Range point, it is automatically transposed, to stay in the programmed range.

Off No Keyboard Range used.

Wrap Around

The wrap-around point is the highest key range limit for the backing track. The accompaniment patterns will be transposed according to the detected chord. If the chord is too high, the Style tracks might play in a range that is too high, and therefore unnatural. If, however, it reaches the wrap-around point, it will be automatically transposed an octave lower.

The wrap-around point can be individually set for each track in semitone steps up to a maximum of 12 semitones, relative to the chord root set in Style Record mode (see “Key/Chord” on page 135).

It is advisable to set different Wrap Around points for each track, to avoid all tracks “jump” to a different octave at the same time. We suggest to consider the actual range of the real instrument.

1...12 Maximum transposition (in semitones) of the track, referred to the original key of the Style pattern.

Play/Mute icon

Track’s play/mute status.

 Play status. The track can be heard.

 Mute status. The track cannot be heard.

Page menu

Touch the page menu icon to open the menu. Touch a command to select it. Touch anywhere in the display to close the menu without selecting a command.

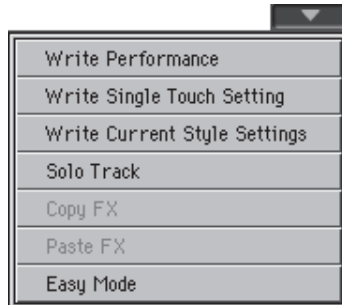

Write Performance

Select this command to open the Write Performance dialog box, and save most of the current control panel settings to a Performance.

See “Write Performance dialog box” on page 128 for more information.

Write Single Touch Setting

Select this command to open the Write Single Touch Setting (STS) dialog box, and save Keyboard track settings to one of the Single Touch Settings (STS) of the current Style.

See “Write Single Touch Setting dialog box” on page 128 for more information.

Write Current Style Settings

Select this command to open the Write Current Style Settings dialog box, and save Style track settings to the current Style.

See “Write Single Touch Setting dialog box” on page 128 for more information.

Solo Track

Select the track to be soloed, and check this item. You will hear only the selected track, and the ‘Solo’ warning will flash on the page header.

Uncheck this item to exit the Solo function.

The Solo function works in a slightly different way, depending on the selected track:

- **Keyboard track:** The selected Keyboard track is the only track you can hear when playing on the keyboard. All other Keyboard tracks are muted. The status of the Style tracks is unaffected.
- **Style track:** The selected track is the only Style track you can hear. All other Style tracks are muted. The status of the Keyboard tracks is unaffected.
- **Grouped Style tracks:** The Solo function does not work on these special tracks.

SHIFT Keep the SHIFT button pressed and touch one of the tracks to solo it. Do the same on a soloed track to deactivate the Solo function.

Copy/Paste FX

You can copy a single effect (Master 1, Master 2), or both effects of an FX group (A or B). You can copy them between different elements (for example, between Styles and Performances, or STSs and Songs or Sounds).

Note: This operation only copies the parameters of the “Effects” section. Parameters contained in other sections, like “Dry” or “FX Send”, are not copied. Please note that these parameters are relevant in the overall sound of the effect, so please fine-tune them.

To copy a single effect:

1. Select the source Performance, STS, Style, Song or Sound.
2. Choose the source FX group (A or B) by touching the corresponding side tab.
3. Go to the page of the single effect you want to copy (Master 1, Master 2).
4. Choose the “Copy FX” command from the page menu.
5. Select the target Performance, STS, Style, Song or Sound,
6. Choose the same FX group (A or B) as the target by touching the corresponding side tab.
7. Go to the page of the single effect you want to paste (Master 1, Master 2).
8. Choose the “Paste FX” command from the page menu.

To copy all the effects in an FX group:

1. Select the source Performance, STS, Style, Song or Sound, then go to the Effects > A/B FX Config page, to copy all the effects.
2. Choose the source FX group (A or B) by touching the corresponding side tab.
3. Choose the “Copy FX” command from the page menu.
4. Select the target Performance, STS, Style, Song or Sound, then go to the page of the Effects > A/B FX Config page.
5. Choose the FX group (A or B) as the target by touching the corresponding side tab.
6. Choose the “Paste FX” command from the page menu.

Easy Mode

Easy Mode allows you to use the Style Play and Song Play modes with an easier-to-use user interface. It is recommended to beginners, and to professionals alike that do not want to deal with the extra parameters of the Advanced mode.

At any time, you can manually turn the Easy Mode on/off with the Easy Mode command in the page menu of the Style Play and Song Play modes.

Write Performance dialog box

Open this window by keeping one of the PERFORMANCE buttons pressed for about one second, or by choosing the Write Performance item from the page menu. Here, you can save all track settings, the selected Style, and various Style settings to a Performance.

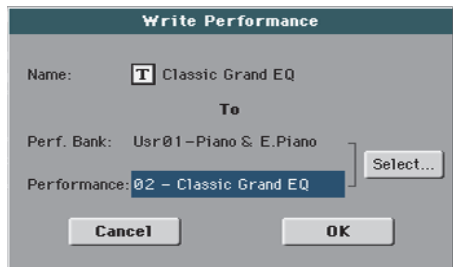

Name

Name of the Performance to be saved. Touch the **T** (Text Edit) button next to the name to open the Text Edit window.

Perf Bank

Target bank of Performances. Each bank corresponds to one of the PERFORMANCE buttons. Use the VALUE DIAL to select a different bank.

Performance

Target Performance location in the selected bank. Use the VALUE DIAL to select a different location.

Select... button

Touch this button to open the Performance Select window, and select a target location.

Write Single Touch Setting dialog box

Open this window by keeping one of the STS buttons pressed for about one second, or by choosing the Write Single Touch Setting item from the page menu. Here, you can save Keyboard track settings, and the selected Voice Processor Preset, to one of the four single Touch Settings (STS) belonging to the current Style.



Note: When the “Factory Style and Pad Protect” option is checked in the Global > Mode Preferences > Media page, you cannot write an STS over a Factory Style. The “Write Single Touch Setting” command in the page menu is greyed out and cannot be selected. All original settings of the Factory Styles will be left untouched.

Name

Name of the STS to be saved. Touch the **T** (Text Edit) button next to the name to open the Text Edit window.

Current Style

Non editable. Settings are saved in one of the four STSs belonging to the current Style. This parameter displays the name of the “parent” Style.

STS

Target STS location. The name of the STS currently saved at the target location is shown. Use the VALUE DIAL to select a different location.

Write Current Style Settings dialog box

Open this window by keeping one of the STYLE buttons pressed for about one second, or by selecting the Write Style Settings item from the page menu. Here, you can save Style track settings to the Style Settings of the current Style.

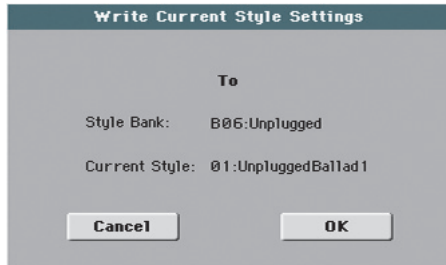

Note: When the “Factory Style and Pad Protect” option is checked in the Global > Mode Preferences > Media page, you cannot write any Style Settings onto Factory Styles. The “Write Current Style Settings” command in the page menu is greyed out and cannot be selected. All original settings of the Factory Styles will be left untouched.

Style bank

Non editable. Bank of Styles the current Style belongs to.

Current Style

Non editable. Name of the current Style.

The Favorite banks

You can create a custom set of Styles, made of up to twelve Favorite banks. You can assign a different name to the tabs that appear in the Style Select window, in order to add musical genres not included among the Factory Styles.

The Favorite Styles are contained in twelve files, automatically created by the Pa900 inside the Style folder in the SYS area of the internal storage memory. Even if different bank names can appear in the display, these files have fixed names:

File Name	FAVORITE Banks
FAVORITE01...12.STY	Bank 1...12

Creating the Favorite banks

There are various ways to create the Favorite banks:

- While in Style Play mode, you can copy & paste any Style into the Favorite banks, as an alternative to the User Style banks. See the “Selecting” chapter for more information on the Copy & Paste operations.
- While in Style Record mode, you can write the new or edited Style to the Favorite banks, as an alternative to the User Style banks. See the “Style Record” chapter for more information on saving a Style.
- While in Media mode, you can load any Style into the Favorite banks, as an alternative to the User Style banks. See the “Media” chapter for more information on the Load operations.

Renaming the Favorite banks

While the Style Select window is in the display, you can choose the “Rename Favorite” command from the page menu, and assign the Favorite Style tabs any name you like.



The assigned name can be spanned over two lines, by separating them with the paragraph character (¶). For example, to write “World Music” on two lines, enter “World¶Music”.

Be careful not to write words exceeding the width of the side tabs of the Style Select window.

Style/Pad Record mode

By entering the Style/Pad Record mode, you can create your own Styles or Pads, or edit an existing Style or Pad.

Recording Styles and Pads

Styles and Pads share most of the same structure and recording/editing operations. Here is how they are made.

The Style's structure

The term "Style" relates with music sequences automatically played by the arranger of the Pa900. A Style consists of a pre-defined number of **Style Elements (E)** (Pa900 features fifteen different Style Elements: Variation 1-4, Intro 1-3, Fill 1-4, Break, Ending 1-3). When playing, most of these Style Elements can be directly selected by using the corresponding buttons on the control panel.

To explain the Style structure, we can use a tree structure, as shown in the following diagram:

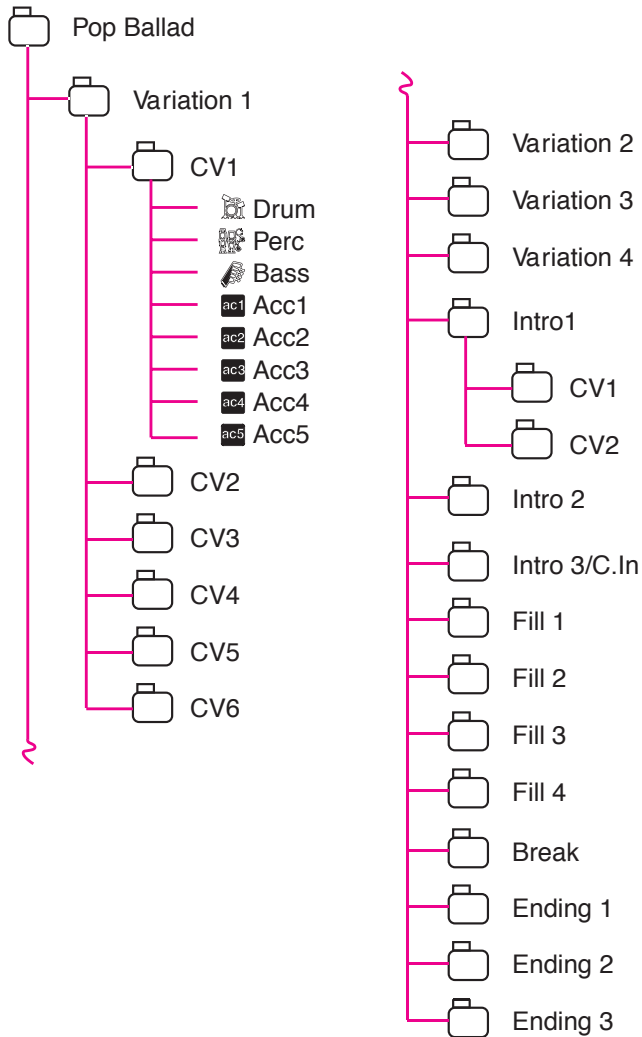

Each Style Element is made up of smaller units, called **Chord Variations (CV)**, but not all of them have the same number of CVs. Variations 1-4 have up to 6 CVs each, while the other Style Elements have only up to 2 CVs.

When you play in the chord recognition area (Lower, Upper or Full, depending on the On or Off status of the SPLIT button), the arranger scans the keyboard and determines which chord you are playing. Then, depending on the selected Style Element, it determines which Chord Variation (CV) should be played for the scanned chord. Which Chord Variation corresponds to each scanned chord is a setting of the Style: the **Chord Variation Table**. Each Style Element contains a Chord Variation Table, whose prototype is the following:

Chord	Chord Variations (CVs)	
	Variation 1-4	Intro 1-2, Count-In, Fill 1-4, Break, Ending 1-3
Major	CV1 - CV6	CV1 - CV2
6		
M7		
M7 ^(b5)		
sus		
sus2		
M7sus		
m		
m6		
m7		
m7 ^(b5)		
m ^(M7)		
7		
7 ^(b5)		
7sus4		
dim		
dim ^(M7)		
#5		
7 ^(#5)		
M7 ^(#5)		
1+5		
1+8		
b5		
dim7		

After deciding what CV to play, the arranger triggers the right sequence for each track. Since each sequence is written in a particular key (for example, CMajor, GMajor or Emin), the arranger transposes it according to the scanned chord. Notes in the sequence are carefully transposed, to make them work fine with all recognized chords.

Going deeper into the Style structure, we can see that each Chord Variation is made up of **Track Sequences**, and the Pa900 supports 8 different tracks. DRUM and PERC are used for drum and percussion sequences, BASS for bass and ACC1-5 are for

accompaniment sequences (string, guitar, piano or other accompaniment instruments).

Just to summarize, when you play a chord on the chord recognition area, the arranger determines which Style Element is used, then determines which Chord Variation should be used for the played chord, then Style sequences for every track of that Chord Variation are transposed from the original chord to the recognized chord, and so on every time you play a chord.

The Pad's structure

A Pad is basically a single-track Style. Most of what applies to Style recording also applies to Pad recording.

There are two different categories of Pads:

- “Hit” Pads. While they are mostly used as non-transposing events, they can also be transposing notes or chords. Basically, they are single-note or single-chord Sequences (see below).
- “Sequence” Pads, i.e., complex single-track patterns, that can be transposed by playing different chords on the keyboard – exactly as a Style track. They are roughly equivalent to single-element, single-track, multi-chord variation Styles (see illustration).

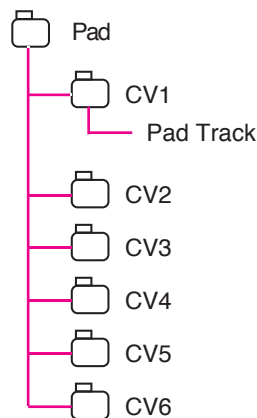

Each Pad is made up of up to six smaller units, called **Chord Variations (CV)**. Each Chord Variation is made of a single track (the Pad track).

Exactly as with the Styles, when playing a chord in the chord recognition area, the corresponding Chord Variation is recalled. Recognized chords are associated to a Chord Variation by means of the **Chord Variation Table**. Each Pad contains a Chord Variation Table.

As with the Styles, the **Note Transposition Tables (NTT)** applies to the Pads.

The same differences between the different types of tracks applies (see “Track Type” on page 155).

Ordinary, Guitar and Drum tracks

There are different types of tracks (see “Track Type” on page 156), and each of them is treated in a different way by the arranger;

- Acc (Accompaniment) and Bass tracks: When a chord is recognized, the programmed chord notes are transposed to a suitable scale, according to the **Note Transposition Tables (NTT)**. The NTT allows you to record just some Chord Variations, and have all the notes play in the right place, avoiding dissonances and transposing the pattern notes to the notes of the recognized chord.
- Drum & Perc (Percussion) tracks: No transposition is applied. The original pattern plays always.

- Gtr (Guitar) tracks: When a chord is recognized, the arranger triggers single notes, strumming and arpeggios on a “virtual guitar”, keeping care of the way notes are played on the guitar keyboard. Note that inside a Guitar track you can also have some parts typical of an Acc track - a useful addition for short “free-form” passages.

What to record in a Style

Recording a Style means recording tracks, inside a series of Chord Variations, inside a series of Style Elements, inside the Style itself.

You don't have to record all Chord Variations for all Style Elements. It is often only needed to record a single Chord Variation for each Style Element. Exceptions are the Intro 1 and Ending 1, where we suggest to record both a Major and minor Chord Variations.

What to record in a Pad

Recording a Pad is a matter of recording a single track, inside a series of Chord Variations, inside the Pad itself.

You don't need to record all Chord Variations. It is often only needed to record just a Chord Variation.

Pattern data vs. track data

While the Style/Pad Record mode is where you can create or edit the music patterns, track parameters (like Volume, Pan, Octave Transpose, FX settings...) are to be edited in Style Play mode.

- After having created or edited music patterns in Style/Pad Record mode, save them by selecting the “Write Style” or “Write Pad” command from the page menu of the Style Record mode (see “Write Style/Pad dialog box” on page 162).
- After having edited track parameters in Style Play mode, save them to the Style Settings by selecting the “Write Current Style Settings” command from the page menu of the Style Play mode (see “Write Current Style Settings dialog box” on page 129).

Sounds

There are two ways of assigning Sounds to the Style tracks.

- While in Style Record mode you can assign different Sounds to each Style Element in the “Style Element Track Controls: Sound/Expression” page (see “Sounds area” on page 137). You can assign a Sound to the Pad in the same page of the Pad Record mode.
- While in Style Play mode, you can assign a single Sound to the Style Settings (together with the other track parameters), that remains the same for all Style Elements.

Which Sounds are used by the Style tracks depends on the status of the “Original Style Sounds” parameter (see page 110).

Note: When assigning a Sound in Style Play mode, the “Original Style Sounds” parameter is automatically turned off.

Style/Pad Import/Export

As an alternative to creating Styles on the Pa900, you can import a Standard MIDI Files (SMF) from your computer to a Pa900's Style. See "Import: Import SMF" on page 157 and "Export SMF" on page 160.

Entering the Style/Pad Record mode

While in the Style Play operating mode, press the RECORD button. The following page will appear in the display:



You can edit Factory Styles or Pads, assuming the status of the "Factory Style and Pad Protect" parameter in the Global > Mode Preferences > Media page is set to Off (see page 254)

- Select **Record/Edit Current Style** to edit the current Style.
- Select **Record New Style** to start from a new, empty Style. Default Style Settings will be recalled. When finished recording, you will save the new Style onto a Favorite or User Style location. (Styles may also be saved onto Factory Style locations only when the "Factory Style and Pad Protect" parameter is set to Off).
- Select **Record/Edit Pad** to select an existing Pad to edit.
- Select **Record New Pad** to start from a new, empty Pad. When finished recording, you will save the new Pad into a User Pad location. (Pads can be saved into Factory Pad locations only when the "Factory Style and Pad Protect" parameter is set to Off).

After having edited the Style or Pad, please save it (see "Exit by saving or deleting changes" below) and exit the Style/Pad Record mode.

Then, edit the Style or Pad track settings.

- *With a Style:* Go to the Style Play mode, edit the Style Settings to adjust track settings (Tempo, Volume, Pan, FX Send... see page 113 and following in the "Style Play mode" chapter) and save it by selecting the "Write Current Style Settings" from the page menu (see "Write Current Style Settings dialog box" on page 129).
- *With a Pad:* Go to the Pad page of the Style Play or Song Play mode, assign the new Hit or Sequence to a Pad button, and adjust the various Pad settings (Volume, Pan, and FX Send... see "Pad/Switch: Pad" on page 125). Finally, save the Pad settings by selecting the "Write Current Style Settings" command from the page menu.

Note: After a record or edit operation, the memory is automatically reorganized. Therefore, when you press START/STOP there is a delay before you can actually listen to the Style. This delay is higher with a Style containing more MIDI events.

Note: While in Record mode, the footswitch is disabled. On the contrary, volume/expression-type pedals can be used.

Exit by saving or deleting changes

When finished editing, you can save your Style or Pad in memory, or abort any change.

- To save changes, select the "Write Style/Pad" command from the page menu (see "Write Style/Pad dialog box" on page 162).
- To abort all changes, select the "Exit from Record" command from the page menu, or press the RECORD button, to exit from record and return to the main page of the Style Play mode.

Hint: Save often while recording, to avoid accidentally losing your changes to the Style/Pad.

Listening to the Style while in Edit mode

While you are in Style/Pad Record mode, you can listen to the selected Chord Variation or to the whole Style or Pad, depending on the page you are in.

To select a Chord Variation, go to the Main page of the Record/Edit mode. For more details, see "Element (Style Element)" and "Chord Var (Chord Variation)" on page 134.

- When you are in the Main, Event Edit, Quantize, Transpose, Velocity, or Delete pages, you can listen to the selected Chord Variation. Press START/STOP to check how it works. Press START/STOP again to stop the playback.
- When you are in the Sounds/Expression, Keyboard Range, Chord Table, Trigger/Tension, Delete All, Copy, Style/Pad Element Controls or Style/Pad Control pages, you can listen to the whole Style or Pad. Press START/STOP and play some chords to do your tests. Select any Style/Pad Element using the control panel buttons (VARIATION 1-4, INTRO 1-3, AUTO FILL, BREAK, ENDING 1-3). Press START/STOP again to stop the playback.
- When you are in the Guitar Mode page, you can listen to the pattern you are programming, played in the selected Key.

Note: When entering Style Record mode, the Chord Recognition mode changes according to the mode that was selected while in Style Play mode. For a chord to be recognized, a minimum of three notes must be played.

Chord Recognition Mode		
Style Play mode	Style Record mode	Notes (min.)
One Finger	Fingered	3
Fingered	Fingered	3
Expert	Expert	3

Note: In this mode, the pattern is always played back in loop, even if the "Pad Type" parameter is set to "One Shot" (see page 155).

List of recorded events

The Style/Pad Record mode filters out some events that may cause wrong operation of the Style or Pad. Here are the recorded events.

Control function	CC#
Allowed	
Note On	
RX Noise On	
Pitch Bend	
Channel After Touch	
Modulation	1
Breath	2
Pan	10
Expression	11
CC#12	12
CC#13	13
Damper (Hold 1)	64
Filter Resonance (Harmonic Content)	71
Low Pass Filter Cutoff (Brightness)	74
CC#80 (General Purpose #5)	80
CC#81 (General Purpose #6)	81
CC#82 (General Purpose #7)	82

Note: Some Control Change messages cannot be recorded directly by using the integrated controls of Pa900.

All allowed controllers can be assigned to an Assignable Pedal/Slider/Switch.

MIDI Control Change messages inserted by using a software on an external computer are imported when using the Import function ("Import: Import SMF" on page 157).

Some controllers are reset at the end of the pattern.

Main page - Record 1

After having pressed the RECORD button, and having chosen whether you want to edit an existing Style or create a new one, the main page of the Style Record mode appears, with the tab "Record 1" selected.

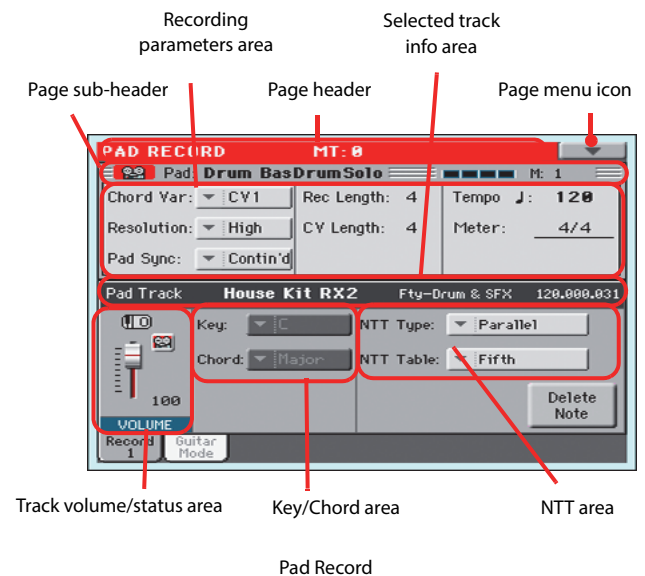
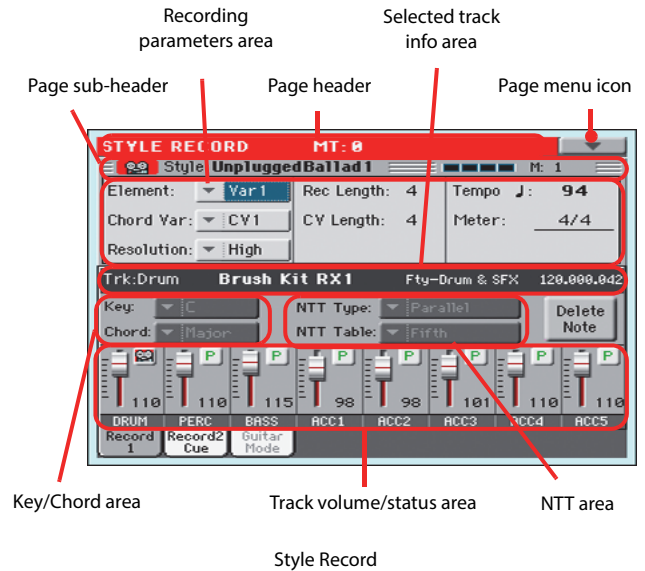

Page header

This line shows the current operating mode and transposition.



Operating mode Master Transpose (in semitones)

Operating mode name

Name of the current operating mode.

Master Transpose

Master Transpose value in semitones. This value can be changed using the TRANSPOSE buttons on the control panel.

Page menu icon

Touch this icon to open the page menu. See “Page menu” on page 161.

Page sub-header

This area shows some performing info on the Style/Pad.



Style in record/edit

Name of the Style currently in edit or record.

Beat counter

This indicator shows the current beat.

Measure number

Current measure you are recording.

Recording parameters area

Element (Style Element)

(Style only) This parameter lets you select a Style Element for editing. Each Style Element corresponds to a button on the control panel carrying the same name. After selecting a Style Element, select a Chord Variation for actual editing (see below).

Var1...End3 This is the selected Style Element

Chord Var (Chord Variation)

This parameter lets you select a Chord Variation for editing (inside the selected Style Element or Pad).

Note: When this parameter and the assigned value is in small letters (cv1...cv6), the Chord Variation is empty; when it is in capitals (CV1...CV6), it is already recorded.

- If the Style Element is Var1, Var2, Var 3 or Var4, you can select one of 6 Chord Variations to edit.
- If the Style Element is Intro1, Intro2, Intro3, Fill1, Fill2, Fill3, Fill4, Ending1, Ending2 or Ending3, you can select one of 2 Chord Variations to edit.
- With a Pad you can choose one of the six available Chord Variations (CV1 ... CV6).

Resolution

Use this parameter to set the quantization during recording. Quantization is a way of correcting timing errors; notes played too soon or too later are moved to the nearest axis of a rhythmic “grid”, set with this parameter, thus playing perfectly in time.

Note: To quantize after recording, use the Quantize function in the Edit section (see “Style/Pad Edit: Quantize” on page 148).

High No quantization applied.

♩ (1/32)... ♩ (1/8)

Grid resolution, in musical values. For example, when you select 1/16, all notes are moved to the nearest 1/16 division. When you select 1/8, all

notes are moved to the nearest 1/8 division. A ‘3’ after the quantization value means triplet.

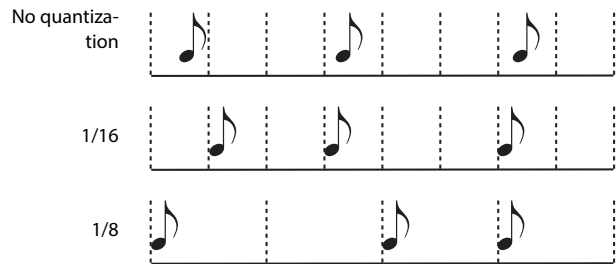

Pad Sync

(Pad only) This parameter allows you to set a synchronization mode for the Pad’s pattern.

- Off No synchronization. The sequence will start as soon as you press the PAD button.
- Continued The pattern will start immediately, in sync with the arranger’s or active player’s tempo. Depending on the current position of the beat counter, it might not start from its very beginning; instead, it will continue from the current position.

For example, if the arranger’s or player’s beat counter shows the third beat, and is playing tick 91, the Pad will start from its third beat, at tick 91.

The beat counter

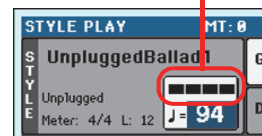

This works exactly as if it was a Fill.

- Beat The sequence will start at the next beat, in sync with the arranger’s or player’s tempo. It will start from its very beginning (i.e., tick 1 or measure 1).

Rec Length (Recording Length)

This parameter sets the recording length (in measures) of the selected track. Its value is always equal to, or a divider of, the Chord Variation Length (see next parameter).

This is not the total length of the Chord Variation, but just of the current track. For example, you may have a Chord Variation eight measures long, with a drum pattern repeating each two measures. If so, set the CV Length parameter to “8”, and the Rec Length parameter to “2” before starting recording the Drum track. When playing back the Style, saving it or executing any edit operation on the Style, the 2-measures pattern will be extended to the full 8-measures length of the Chord Variation.

Warning: If you assign a value lower than Rec Length to CV Length, the value of Rec Length is not immediately updated in the display. Therefore, you are still free of changing the value of CV Length, before the measures exceeding its value are deleted. For more details, see the warning in “CV Length (Chord Variation Length)” below.

However, if you press START/STOP to begin recording, the real Rec Length value is changed to the new one, even if the display still shows the old value.

For example, you may have CV Length = 4 and Rec Length = 4. If you set CV Length to 2, and press START/STOP to begin recording, Rec Length is still shown as 4, but it is in reality set to 2, and recording will cycle for just 2 measures. After you press START/STOP to stop recording, Rec Length is updated to 2, and all measures after the second measure are deleted.

CV Length (Chord Variation Length)

This parameter sets the total length (up to 32 measures) for the selected Chord Variation. When playing a Style, this will be the length of the accompaniment pattern, when the chord corresponding to the Chord Variation is recognized on the keyboard.

Warning: If you reduce the Chord Variation Length after recording, any measure after the selected length will be deleted. Be very careful when setting the CV Length to a lower value after recording! If it happens, we suggest to exit from record without saving (see “Exit from Record” on page 161).

Tempo

Select this parameter to use the TEMPO controls to set the Tempo value.

Hint: You can always change the Tempo, when other parameters are selected, by keeping the SHIFT button pressed, and rotating the DIAL.

Note: When recording Tempo, old data is always replaced by the new data.

Note: The actual Tempo of the Style will be the one shown when saving the Style Settings in Style Play mode (see “Current Tempo” on page 107).

Meter

This is the meter (time signature) of the Style Element or the Pad Sequence. You can edit this parameter only when the Style Element or Pad is empty, i.e. before you begin recording anything.

Selected track info area

This line lets you see the Sound assigned to the selected track.

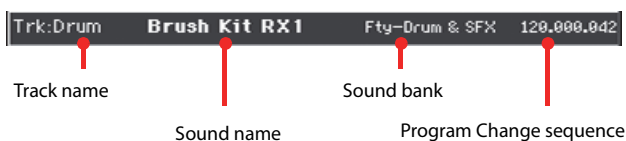

Track name

Name of the selected track.

Drum...Acc5 Style track.

Sound name

Sound assigned to the selected track. You can touch the name to open the Sound Select window, and select a different Sound.

Sound bank

Bank the selected Sound belongs to.

Program Change

Program Change number sequence (Bank Select MSB, Bank Select LSB, Program Change).

Key/Chord area

Key/Chord

This parameter pair allows you to define the track's original key and chord type, for the current Chord Variation. When playing the pattern back, this chord will be played back exactly as it was recorded, without any NTT processing (see above).

Note: To conform to Korg specifications, it is advisable to record both the “Major” and “minor” Chord Variations for the Intro 1 and Ending 1 Style Elements.

When you select a track, the original key/chord assigned to the selected track will be shown. All recorded tracks will play back on that key/chord. For example, if the original key/chord for the Acc1 track is A7th, when selecting the Acc1 track all the remaining tracks will play on the A7th key/chord.

In the example above, you will record the Acc1 track in the AMajor key, with notes pertaining to the A7th scale. This exact pattern will be recalled, when an A7th chord will be recognized.

Note: This does not apply to Guitar Mode, relying on a different rule. See “Main page - Guitar Mode” on page 138 for more information.

NTT Area

NTT Type/Table

NTTs (Note Transposition Tables) are the sophisticated algorithms that allow Korg arrangers to convert recognized chords into musical patterns. The Note Transposition Table (NTT) determines how the arranger will transpose pattern notes, when a chord is recognized that does not exactly match the original chord of a Chord Variation. For example, if you only recorded a Chord Variation for the CMaj chord, when a CMaj7 is recognized on the keyboard the arranger must transpose some notes to create the missing 7th.

Note: These parameters cannot be selected with Drum or Percussion tracks, and are therefore greyed out.

Note: NTT parameters are separately programmed for each track of the Style Element.

There are two general types of NTTs:

- When **Parallel** types are selected, notes are transposed inside the area set by the Wrap Around parameter. These tables are ideally suited to melody parts.

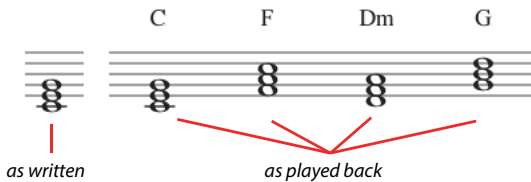

- When **Fixed** types are selected, the arranger moves as few notes as possible, making legato lines and chord changes more natural. They are ideally suited to chord tracks (strings, piano etc...).

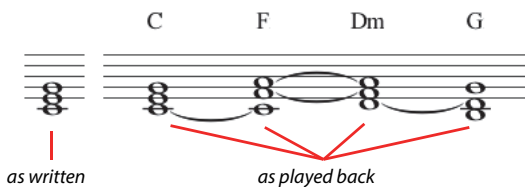

Note: To conform to Korg specifications, it is advisable to set the NTT to "No Transpose" on the Intro 1 and Ending 1.

Parallel/Root The root note (in CMaj = C) is transposed to the missing notes.

Parallel/Fifth The 5th note (in CMaj = G) is transposed to the missing notes.

As recorded with
NTT = Root or 5th
(Key/Chord = C)



When you play a C7
with NTT = Root



When you play a C7
with NTT = 5th



Parallel/i-Series

All original patterns must be programmed on the "Maj7" or "min7" chords. When loading old Korg i-Series Styles, this option is automatically selected.

As recorded with
NTT = i-Series
(Key/Chord = CM7)



When you play a C
with NTT = i-Series



When you play a C7
with NTT = i-Series



Parallel/No Transpose

The chord is not modified, and is moved to the new key unchanged. The pattern plays exactly the recorded notes, and is moved to the new key as is. This is the standard setting of Intro 1 and Ending 1 in Korg's original Styles (where a chord progression is usually recorded, and should remain unchanged in any key).

Fixed/Chord This table moves as few notes as possible, making legato lines and chord changes more natural. It is ideally suited to chord tracks (strings, piano etc...). Contrary to the Parallel mode, the programmed chord is not transposed according to the Wrap Around parameter, but always stays around its original position, looking for common notes between the chords.

Fixed/No Transpose

The programmed notes can only be transposed by the Master Transpose. They are never transposed when chords are changed.

Delete Note button

Use this command to delete a single note or a single percussive instrument from a track. For example, to delete a snare, keep the D2 note (corresponding to the snare) pressed.

1. Select a track.
2. Touch the “Delete Note” button, and keep it pressed.
3. Press START/STOP to start the Style.
4. When you reach the passage containing the note to be deleted, play the note on the keyboard. Keep it pressed, up to the last note to be deleted.
5. When finished, release the Delete button and the note to be deleted, and press START/STOP again to stop the Style.

Note: If the note is at the beginning of the pattern, press the note before starting the Style.

Tracks volume/status area

Virtual slider(s)

Drag a virtual sliders on the display to change the volume of the corresponding track.

As an alternative, touch a track to select it, and use VALUE DIAL to change the value.

Track status icons

Status of tracks. Touch this icon to change the status.



Play status. The track can be heard.



Mute status. The track cannot be heard.



Record status. After starting recording, the track will receive notes from the keyboard and the MIDI IN connector.

Track names

(Style only) Under the sliders, a label for each track is shown.

Drum...Acc5 Shown Style tracks.

Main page - Record 2/Cue

(Style only) While in the main page, touch the “Record 2/Cue” tab to see this page. Most parameters in this page are the same as in “Main page - Record 1”. In addition, here you can see and select Sounds for each Style track, and the Cue mode for the Style Element.

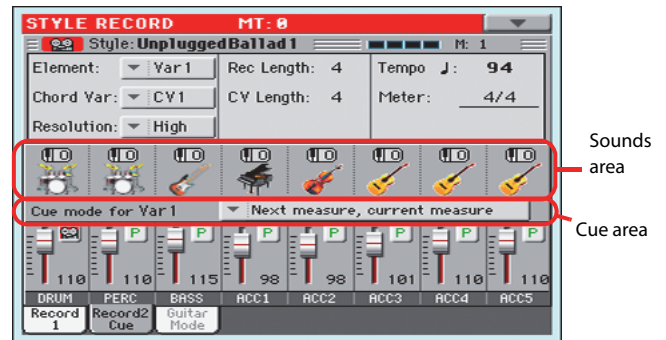

Sounds area

This area lets you see Sounds and octave transposition for the eight Style tracks.

Octave transpose icon



Sound bank's icon

Octave transpose icon

Non editable. This indicator shows the track's octave transposition. Tracks will be recorded with the selected octave transposition. To change this value, use the UPPER OCTAVE buttons, or go to the “Mixer/Tuning: Tuning” edit page in the Style Play mode (see page 116). Save this value to the Style Settings.

Sound bank's icon

This picture illustrates the bank the current Sound belongs to. Touch an icon a first time to select the corresponding track (detailed information are shown on the Selected Track Info area, see the “Main page - Record 1” page above). Touch it a second time to open the Sound Select window.

Note: These Sounds can be replaced by Sounds selected by a Performance, provided the “Original Style Sounds” parameter is left unchecked in Style Play mode (see page 110).

Cue area

Cue mode for [Style element]

This parameter lets you decide how the current Style Element will enter after it has been selected. This setting is only available for the 'Variation' and 'Fill' Style Elements.

Immediate, first measure

The Style Element enters immediately, and begins from the first measure. *Only available on Fills.*

Immediate, current measure

The Style Element enters immediately, and begins from the current measure. *Only available on Fills.*

Next measure, first measure

The Style Element enters at the beginning of the next measure, and begins from the first measure of the new pattern. *Available on both Fills and Variations.*

Next measure, current measure

The Style Element enters at the beginning of the next measure, and begins from the current measure. *Only available on Variations.*

Main page - Guitar Mode

While in the main page, and a Guitar track has been selected, touch the "Guitar Mode" tab to see this page. This is where you can access Guitar Mode programming:



Note: To access this page, a Guitar track must first be selected (see "Track Type" on page 156). The Pad track must be of Guitar type (Pad Track Controls > Sound/Expression page, see "Track Type" on page 155). Otherwise, the Guitar Mode tab will remain grey (not selectable).

Note: When programming a Guitar track from an external sequencer, you must be sure the Guitar tracks is associated to the right channel. Go to the Global > MIDI > MIDI IN Channels page, and assign the corresponding Style track (usually Acc1 ~ Acc5) to the same channel of the Guitar track on the external sequencer. Then, go to the Style Record > Style Track Controls > Type/Tension/Trigger page, and set the track as a track of type "Gtr" (see "Track Type" on page 156).

Guitar Mode allows for easy creation of realistic rhythm guitar parts, without the artificial, unmusical playing typical of MIDI programming of guitar parts. Just record a few measures, and you will end up with realistic rhythm guitar tracks, where each chord is played according to its real position on the guitar, and not generated by simply transposing a written pattern.

Recording overview

Recording a Guitar track is unlike recording the other tracks, where you play exactly all the notes of a melody line or all the chords of an accompaniment part. With Guitar tracks you can:

- play the keys corresponding to the strumming modes,
- play an arpeggio using the six keys corresponding to the six guitar strings (and the special keys corresponding to the root and fifth notes),
- play RX Noises to add realism to the pattern,
- add regular patterns, for short melodic passages without wasting an Acc track,
- use the finest MIDI programming to select Chord Shapes, and recreate any nuance of a guitar performance.

The following sections describe the various control keys available for this guitar simulation.

Recording strumming types

The octave from C1 to B1 is devoted to selecting a **strumming type**. By pressing these keys, you play fast strumming samples:

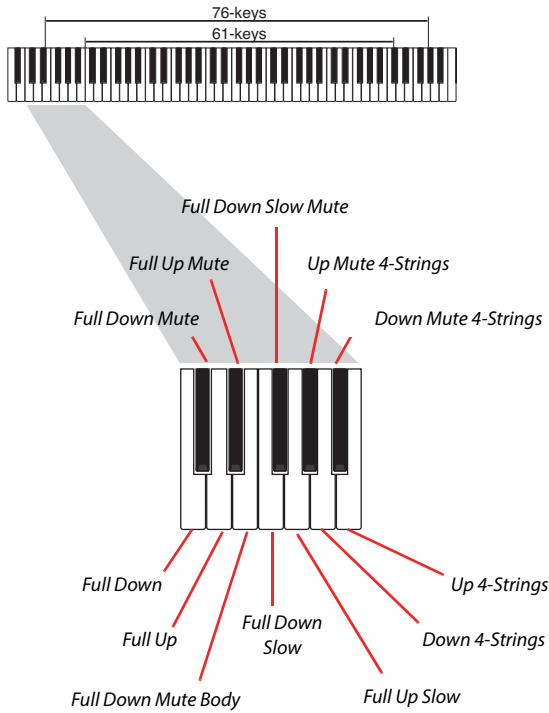

Recording single strings

The octave from C2 to B2 is devoted to selecting a **single string** (or more than one) for playing arpeggios or power chords. You can either play a free arpeggio with the six guitar chords assigned to the C~A keys, or play one of the faster sampled arpeggios on the higher keys. The root note is always available on the C# key, while the fifth note is always assigned to the D# key; with them, you can always play the lowest notes of an arpeggio.

This octave also includes an 'all mute' key (F#):

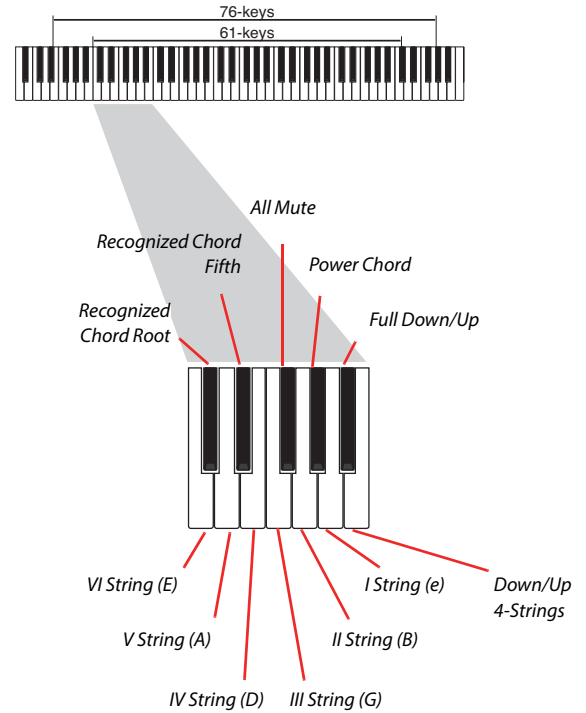

Recording RX Noises

Further on, the upper octaves are used to trigger **RX Noises**:

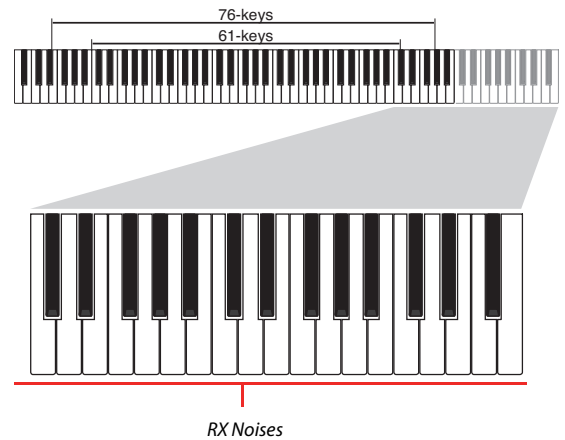

Selecting a Capo

Together with strumming types, single strings and RX Noises, you can choose a Capo ("capotasto"). Note that this might prevent some single strings to sound, depending on the composed chord. You can always see which strings are playing and which are not, as described in "Diagram" on page 141.

Recording a regular pattern

Together with strums and arpeggios, you can record regular patterns, exactly as if the track was of Acc type (see "Track Type" on page 156). This will save an Accompaniment track, when all you need is just to record some short melodic passages (for example, the closing of a strumming pattern).

You can record the pattern by playing it in the range shown by the diagram.

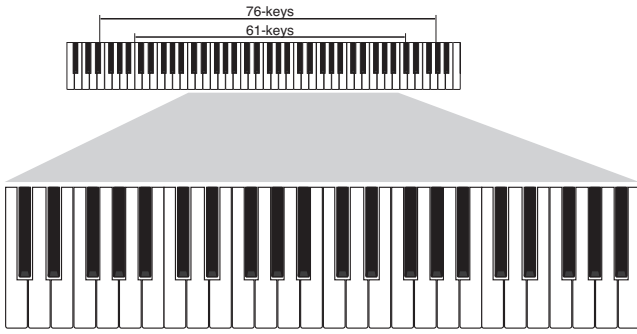

Recording a Chord Shape

You can finely choose Chord Shapes by using MIDI messages. When you play a C0 note with the velocity value shown in the following table, a chord is played in a particular position and on a certain number of strings.

Vel.	Range	from Str.	to Str.	Position
0	6 Strings	I	VI	0
1	6 Strings	I	VI	0
2	6 Strings	I	VI	1
3	6 Strings	I	VI	2
4	6 Strings	I	VI	3
5	6 Strings	I	VI	4
6	6 Strings	I	VI	5
7	5 Strings Bass	II	VI	0
8	5 Strings Bass	II	VI	1
9	5 Strings Bass	II	VI	2
10	5 Strings Bass	II	VI	3
11	5 Strings Bass	II	VI	4
12	5 Strings Bass	II	VI	5
13	5 Strings Treble	I	V	0
14	5 Strings Treble	I	V	1
15	5 Strings Treble	I	V	2
16	5 Strings Treble	I	V	3
17	5 Strings Treble	I	V	4
18	5 Strings Treble	I	V	5
19	4 Strings Bass	III	VI	0
20	4 Strings Bass	III	VI	1
21	4 Strings Bass	III	VI	2
22	4 Strings Bass	III	VI	3
23	4 Strings Bass	III	VI	4
24	4 Strings Bass	III	VI	5
25	4 Strings Middle	II	V	0
26	4 Strings Middle	II	V	1
27	4 Strings Middle	II	V	2
28	4 Strings Middle	II	V	3
29	4 Strings Middle	II	V	4
30	4 Strings Middle	II	V	5
31	4 Strings Treble	I	IV	0
32	4 Strings Treble	I	IV	1
33	4 Strings Treble	I	IV	2

Vel.	Range	from Str.	to Str.	Position
34	4 Strings Treble	I	IV	3
35	4 Strings Treble	I	IV	4
36	4 Strings Treble	I	IV	5
37	3 Strings Bass	IV	VI	0
38	3 Strings Bass	IV	VI	1
39	3 Strings Bass	IV	VI	2
40	3 Strings Bass	IV	VI	3
41	3 Strings Bass	IV	VI	4
42	3 Strings Bass	IV	VI	5
43	3 Strings MiddleBas	III	V	0
44	3 Strings MiddleBas	III	V	1
45	3 Strings MiddleBas	III	V	2
46	3 Strings MiddleBas	III	V	3
47	3 Strings MiddleBas	III	V	4
48	3 Strings MiddleBas	III	V	5
49	3 Strings MiddleTreble	II	IV	0
50	3 Strings MiddleTreble	II	IV	1
51	3 Strings MiddleTreble	II	IV	2
52	3 Strings MiddleTreble	II	IV	3
53	3 Strings MiddleTreble	II	IV	4
54	3 Strings MiddleTreble	II	IV	5
55	3 Strings Treble	I	III	0
56	3 Strings Treble	I	III	1
57	3 Strings Treble	I	III	2
58	3 Strings Treble	I	III	3
59	3 Strings Treble	I	III	4
60	3 Strings Treble	I	III	5
61	2 Strings Bass	V	VI	0
62	2 Strings Bass	V	VI	1
63	2 Strings Bass	V	VI	2
64	2 Strings Bass	V	VI	3
65	2 Strings Bass	V	VI	4
66	2 Strings Bass	V	VI	5
67	2 Strings MiddleBas	IV	V	0
68	2 Strings MiddleBas	IV	V	1
69	2 Strings MiddleBas	IV	V	2
70	2 Strings MiddleBas	IV	V	3
71	2 Strings MiddleBas	IV	V	4
72	2 Strings MiddleBas	IV	V	5
73	2 Strings Middle	III	IV	0
74	2 Strings Middle	III	IV	1
75	2 Strings Middle	III	IV	2
76	2 Strings Middle	III	IV	3
77	2 Strings Middle	III	IV	4
78	2 Strings Middle	III	IV	5
79	2 Strings MiddleTreble	II	III	0
80	2 Strings MiddleTreble	II	III	1
81	2 Strings MiddleTreble	II	III	2
82	2 Strings MiddleTreble	II	III	3
83	2 Strings MiddleTreble	II	III	4
84	2 Strings MiddleTreble	II	III	5
85	2 Strings Treble	I	II	0
86	2 Strings Treble	I	II	1

Vel.	Range	from Str.	to Str.	Position
87	2 Strings Treble	I	II	2
88	2 Strings Treble	I	II	3
89	2 Strings Treble	I	II	4
90	2 Strings Treble	I	II	5

Choosing a Key/Chord for Intro 1 and Ending 1

The pattern is recorded in the key indicated by the Key/Chord pair of parameters. However, this parameter is only used for playback by the Intro 1 and Ending 1 Style Elements. All other Style Elements will be played back according to the recognized chord.

With Intro 1 and Ending 1 (both Chord Variation 1 and 2) you can also prefer to enter a chord progression, to be played on the lowest MIDI octave (C-1 ~ B-1). Chord types are inserted by using velocity values, as shown in the following table:

Vel.	Chord Type	Vel.	Chord Type
1	Major	2	Major 6th
3	Major 7th	4	Major 7th flatted 5th
5	Suspended 4th	6	Suspended 2nd
7	Major 7th suspended 4th	8	Minor
9	Minor 6th	10	Minor 7th
11	Minor 7th flatted 5th	12	Minor major 7th
13	Dominant 7th	14	7th flatted 5th
15	7th suspended 4th	16	Dimished
17	Diminished major 7th	18	Augmented
19	Augmented 7th	20	Augmented major 7th
21	Major w/o 3rd	22	Major w/o 3rd and 5th
23	Flatted 5th	24	Diminished 7th

Playing back the pattern

When in Style Play mode, the recorded Guitar pattern is transposed according to the chord recognized on the keyboard. The way it is transposed depends on the programmed pattern, with the chosen positions, strumming mods, etc...

Guitar mode parameters

Here is a detailed description of the parameters of the Guitar Mode page.

Key/Chord

This parameter pair allows you to define the track's original key and chord type. This parameter works in a different way than the other tracks. While with other tracks this is always the reference key used for NTT transposition, with Guitar tracks there is a difference, whether you are recording a Chord Variation contained in an Intro 1 or Ending 1 Style Element, or any other Chord Variation:

- With Intro 1 and Ending 1, this chord will be used as the reference key for the chord progression.
- With all the other Chord Variations, this chord will be used only for listening during recording. During playback in Style Play mode, the chord will follow chord recognition.

Capo - Fret

A capo (from the Italian "capotasto", "head of fingerboard") is a movable bar attached to the fingerboard of the guitar, to uniformly raise the pitch of all the strings. Its use makes the strings shorter, therefore changing the timbre and position of the chords (but not its shape).

0 Open string – no capo.

I...X Position of the capo over the fingerboard (i.e., "I" corresponds to the first fret, "II" to the second one, and so on).

Strings - High/Low

Use this pair of parameters to choose the strings the pattern will be played on.

1...6 Position of the capo over the fingerboard (i.e., "I" corresponds to the first fret, "II" to the second one).

Diagram

The diagram shows how a chord would be composed on the fingerboard. Here is the meaning of the various symbols:

Red dot Fingered string (i.e., played note).

White dot Fifth, playing on the D#2 key.

X Non played or muted note.

Light grey bar Barré (a finger crossing all the strings, like a mobile capo).

Dark grey bar Capo.

Style/Pad Record procedure

There are two different methods for recording a Style/Pad: Realtime and Step.

- Realtime Recording allows you to record Style/Pad patterns in realtime.
- Step Recording allows you to create a new Style/Pad by entering single notes or chords in each track. This is very useful when transcribing an existing score, or needing a higher grade of detail, and is particularly suitable to create drum and percussion tracks.

In addition, you can program a Style/Pad on a personal computer, and then import it via the Import function (see “Import: Import SMF” on page 157).

Preparing to record



1. If you like to edit an existing Style/Pad, select it.
2. Press the RECORD button to enter the Style/Pad Record mode. You are prompted to either select the Current Style or an existing Pad, or create a New Style or Pad.
Select “Record/Edit Current Style” or “Record/Edit Current Pad” if you want to edit the current Style/Pad, or make a new Style/Pad starting from an existing one. Select “Record New Style/Pad” if you want to start from scratch with an empty Style/Pad.
3. After you select your preferred option, the main page of the Style/Pad Record mode will appear.
4. Use the Element (Style Element) (*Style only*) and Chord Var (Chord Variation) parameters, to select the Chord Variation to be recorded/edited.
Note: For more information on the Style Elements and Chord Variations, and the Style/Pad structure in general, see “The Style’s structure” on page 130 or “The Pad’s structure” on page 131.
5. Use the Rec Length (Recording Length) parameter to set the length (in measures) of the pattern to record.
6. Use the Meter parameter to set the Style Element’s or Pad’s meter (time signature).
Note: You can edit this parameter only if you selected the “Record New Style/Pad” option when entering the Record mode, or when editing an empty Style Element.
7. Select the Tempo parameter and set the Tempo.
8. (*Style only*) Touch the Record 2 tab to see the Sounds area. Here you can assign the right Sound to each Style track.
(*Pad only*) Press the SOUND button to select a Sound to be assigned to the Pad track.
9. If needed, set the Octave Transpose for each track. **Note:** The Octave Transpose will affect only the notes coming from the keyboard, and not from the arranger.
10. At this point, if you want to do a Realtime Recording go on reading “Realtime Record procedure” below. Otherwise, if you prefer to do a Step Record, jump to “Step Record procedure” on page 143.

Realtime Record procedure

1. Select the track to record. Its status icon will turn to ‘Record.’ (For more details, see “Tracks volume/status area” on page 137).

Note: When entering the Record mode, a track is already in Record status. When you press START/STOP after entering the Record mode, you can immediately start recording.

If you like, you can try your part before recording:

- Mute the track, by repeatedly touching its icon status, until the  (Mute) status icon appears.
- Press START/STOP to let any recorded track play back, and practice on the keyboard.
- When you have finished practicing, press START/STOP to stop the arranger, and unmute the track by repeatedly touching its icon status, until the  (Record) status icon appears again.

2. While the shown status icon is Record, press START/STOP to begin recording. A 1-bar precount will play before the recording actually begins. When it begins, play freely. The pattern will last for some measures, according to the Rec Length value, then restart.

Since the recording will happen in overdub, you can add notes on any following passage. This is very useful to record different percussive instruments at any cycle on a Drum or Percussion track.

Note: While recording, the track’s **Keyboard Range** (see page 154) is ignored, and notes can be recorded and played back over the whole keyboard range. The **Local** parameter (see “Local Control On” on page 259) is also automatically set to On, to allow playing on the keyboard.

3. When finished recording, press START/STOP to stop the arranger. Select a different track, and go on recording the full Chord Variation.
Note: You can select a different track only when the arranger is not running.
4. When finished recording the Chord Variation, select a different Chord Variation or Style Element (*Style only*) to go on recording the full Style/Pad.
5. When finished recording the new Style/Pad, select the “Write Style/Pad” command from the page menu, to open the Write Style/Pad dialog box (see “Write Style/Pad dialog box” on page 162) and save it to memory.

To exit the Style/Pad Record mode without saving any change, select the “Exit from Record” command from the page menu, or press the RECORD button.

Step Record procedure

1. While in the main page of the Style/Pad Record mode, select the “Overdub Step Recording” command from the page menu, to enter the Overdub Step Record mode.
2. The “Pos” parameter shows the current position.
 - *If you do not want to insert a note or chord at the current position, insert a rest instead, as shown in step 4.*
 - *To jump to the next measure, filling the remaining beats with rests, touch the Next M. button in the display.*
3. To change the step value, use the “Step Time values” area in the display.
4. Insert a note, rest or chord at the current position.
 - To insert a single note, just play it on the keyboard. The inserted note length will match the step length. You may change the velocity and relative duration of the note, by editing the “Duration” and “Velocity” parameters (see page 164).
 - To insert a rest, just touch the Rest button in the display. Its length will match the step value.
 - To tie the note to be inserted to the previous one, touch the Tie button in the display. A note will be inserted, tied to the previous one, with exactly the same name. You don’t need to play it on the keyboard again.
 - To insert a chord or a second voice, see “Chords and second voices in Step Record mode” on page 183.
5. After inserting a new event, you may go back by touching the Back button in the display. This will delete the previously inserted event, and set the step in edit again.
6. When the end of the pattern is reached, the “End of Loop” event is shown, and the recording restarts from the “001.01.000” position. Any note exceeding the pattern length, inserted at its end, will be reduced to fit the total length of the pattern.

At this point, you may go on, inserting new events in overdub mode (the previously inserted events will not be deleted). This is very useful when recording a drum or percussion track, where you may want to record the bass drum on a first cycle, the snare drum on the second cycle, and the hi-hat and cymbals during the following cycles.

7. When finished recording, touch the Done button in the display to exit the Step Record mode.

A dialog box appears, asking you to either cancel, discard or save the changes.

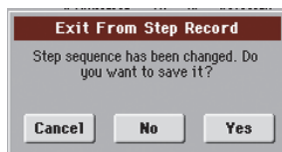

If you touch Cancel, exit is canceled, and you can continue editing. If you choose No, changes are not saved, and the Step Record window is closed. If you choose Yes, changes are saved, and the Step Record window is closed.

8. When back to the main page of the Style Record mode, you may turn all tracks to the play status, then press START/STOP to listen to the Style. Press START/STOP again to stop the playback.
9. From the main page of the Style Record mode, select the “Write Style/Pad” command to save, or the “Exit from Record” command to exit from the Style/Pad Record mode (see “Write Style/Pad dialog box” on page 162), or by canceling any change.

Chords and second voices

With Pa900, you are not limited to inserting single notes in a track. There are several ways to also insert chords and double voices. For more information, see “Chords and second voices in Step Record mode” on page 183.

Edit menu

From any page (apart for Step Record), press the MENU button to open the Style Record or Pad edit menu. This menu gives access to the various Style/Pad Record edit sections.

When in the menu, select an edit section, or press EXIT to exit the menu and return to the main page. To return to the main page, you can also select the Main Page menu item.

When in an edit page, press the EXIT button to return to the main page of the Style Record mode.



Style Record menu



Pad Record menu

Note: While the Style/Pad is in play, you cannot access the Edit section pages from the main page (see page 133). Stop the playback before pressing MENU.

Note: When switching from the Edit section pages (Quantize, Transpose, Velocity, Delete) to the other pages, or vice-versa, the Style (if in play) is automatically stopped.

Edit page structure

Most edit pages share some basic elements.

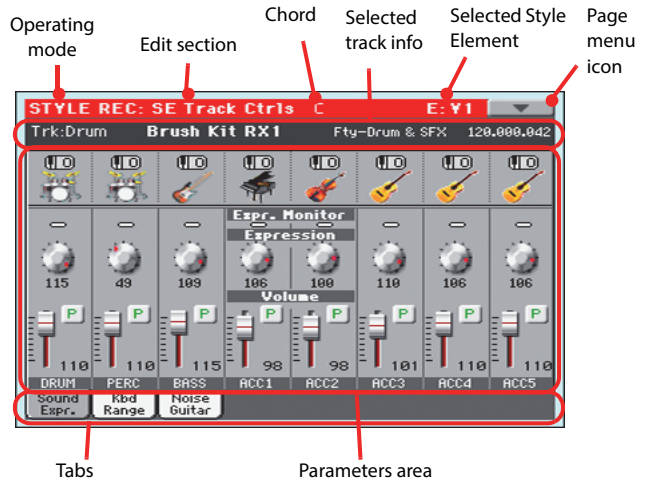

Other pages have a slightly different structure.

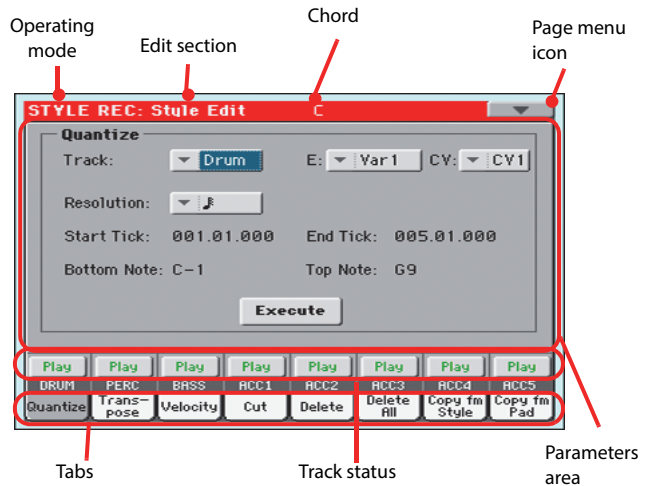

Operating mode

This indicates that the instrument is in Style/Pad Record mode.

Edit section

This identifies the current edit section, corresponding to one of the items of the edit menu (see “Edit menu” on page 144).

Chord

(Style only) Chord in edit.

Selected Style Element

(Style only) In Style Record mode, edits always happen on the selected Style Element.

Page menu icon

Touch this icon to open the page menu (see “Page menu” on page 161).

Parameters area

Each page contains various parameters. Use the tabs to select one of the available pages. For detailed information on the various types of parameters, see sections starting from page 145.

Track status

Use these buttons to mute/unmute tracks while editing.

Tabs

Use tabs to select one of the edit pages of the current edit section.

Event Edit: Event Edit

The Event Edit is the page where you can edit each single MIDI event of the selected Chord Variation. You can, for example, replace a note with a different one, or change its playing strength (i.e., velocity value). See “Event Edit procedure” on page 146 for more information on the event editing procedure.

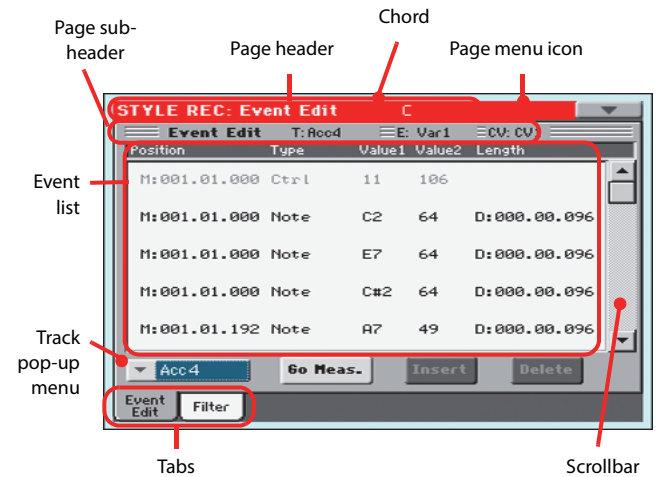

Page header

See “Page header” on page 133.

Page menu icon

Touch this icon to open the page menu. See “Page menu” on page 161.

Page sub-header

This area shows some performing info on the Song.

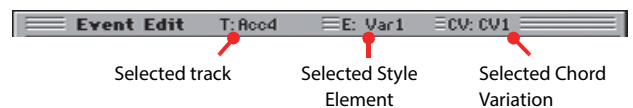

Selected track

(Style only) Name of the track in edit. Use the Track pop-up menu to select one of the Style tracks.

SE/CV (Style Element/Chord Variation)

Selected Style Element (Style only) and Chord Variation. This parameter cannot be edited. To select a different Style Element and Chord Variation, press EXIT to go back to the main page of the Style/Pad Record mode (see “Main page - Record 1” on page 133).

Event list

Use the Event list to see all events contained in the selected track in the selected Style Element.

Use the scrollbar to browse through the events. You can also scroll by using the SHIFT + VALUE DIAL combination.

Touch the event to be selected. Selected events are highlighted and can be heard.

Position

Position of the event, expressed in the form 'aaa.bb.ccc':

- 'aaa' is the measure
- 'bb' is the beat
- 'ccc' is the tick (each quarter beat = 384 ticks)

You can edit this parameter to move the event to a different position. You can edit a position in either of the following ways:

- select the parameter, and use the VALUE DIAL to change the value, or
- select the parameter, then touch it again; the numeric keypad will appear. Enter the new position by dialing in the three parts of the number, separated by a dot. Zeroes at the beginning can be omitted, as well as the least important parts of the number. For example, to enter position 002.02.193, dial "2.2.193"; to enter position 002.04.000 dial "2.4"; to enter position 002.01.000, simply dial "2".

Type, Value 1, Value 2

Type and values of the event shown in the display. Depending on the selected event, the value may change. This parameter also shows the (greyed-out, so non editable) "CC#11" (Expression) event at the beginning of the pattern, and the "End Of Track" marking, when the end of a track is reached.

To change the event type, select the Type parameter, then use the VALUE DIAL to select a different event type. A set of default values will be automatically assigned to the event.

To select and edit the event's value, select the corresponding parameter, and use VALUE DIAL.

Length

Length of the selected Note event. The value format is the same as the Position value. This is only available for Note events.

Note: If you change a length of "000.00.000" to a different value, you can't go back to the original value. This rather uncommon zero-length value may be found in some drum or percussion tracks.

Scrollbar

Use the scrollbar to browse the event through the list. (As an alternative, use SHIFT + VALUE DIAL).

Other elements

Track pop-up menu

Use this pop-up menu to select the track to edit, inside the current Chord Variation.

Drum...Acc5 Style track.

Go Meas.

While the Style is not running, touch this button to open the Go to Measure dialog box:



When in this dialog box, select a target measure, and touch OK. The first event available in the target measure will be selected.

Insert

Touch the Insert button in the display to insert a new event at the current shown Position. The default values are Type = Note, Pitch = C4, Velocity = 100, Length = 192.

Delete

Touch the Delete button in the display to delete the event selected in the display.

Event Edit procedure

Here is the general procedure to follow for the event editing.

1. Select the Style/Pad to edit, and press the RECORD button. Select the "Current Style/Pad" option to enter recording. The main page of the Style/Pad Record mode will appear.
2. Select the "Element (Style Element)" (*Style only*) and "Chord Var (Chord Variation)" parameters.

Note: For more information on the Style Elements and Chord Variations, and the Style structure in general, see "The Style's structure" on page 130.

3. Press MENU, and select the Event Edit section. The Event Edit page appears (see "Event Edit: Event Edit" on page 145 for more information).
4. Press START/STOP to listen to the selected Chord Variation. Press START/STOP to stop it. Chord Scanning does not work, so you will listen the pattern at the original Key/Chord.
5. Touch the Filter tab to select the Filter page, and uncheck the filters for the event types you wish to see in the display (see "Event Edit: Filter" on page 147 for more information).
6. Touch the Event Edit tab to go back to the Event Edit page.
7. (*Style only*) Use the Track pop-up menu to select the track to edit (see "Track pop-up menu" on page 146).
8. The list of events contained in the selected track (inside the Chord Variation selected on step 2) will appear in the display. Some events on the beginning of the Chord Variations, as well as the "EndOfTrk" event (marking its ending point) cannot be edited, therefore appearing in grey.

9. Scroll through the various events by using the scrollbar.
10. Select an event to be edited by touching it in the display. This is usually a note, that you can edit.

M:001.01.000 Note C#2 64 D:000.00.096

For more information on the event types and their values, see “Event Edit: Event Edit” on page 145.

11. Edit the event.
 - Select the “M” parameter. Use VALUE DIAL to change the event’s position.
 - Select the Type parameter. You may use VALUE DIAL to change the event type, as well as its Value 1 and Value 2.
 - If a Note event is selected, select the Length parameter, and use VALUE DIAL to change the event’s length.
12. You may use the Go Meas. command to go to a different measure (see “Go Meas.” on page 146)
13. As described in step 4, you may press START/STOP to listen how the pattern sounds after your changes. Press START/STOP again to stop the pattern running.
14. Touch the Insert button in the display to insert an event at the Position shown in the display (a Note event with default values will be inserted). Touch the Delete button in the display to delete the selected event.
15. When editing is complete, you may select a different track to edit (go to step 7).
16. When finished editing the selected Chord Variation, press EXIT to go back to the main page of the Style Record mode, then go to step 2 to select and edit a different Chord Variation.
17. When finished editing the whole Style, select the “Write Style/Pad” command from the page menu to open the Write Style/Pad dialog box (see “Write Style/Pad dialog box” on page 162), or select the “Exit from Record” command to cancel all changes.
 - Touch the **T** (Text Edit) button to enter the Text Edit dialog box. Enter a name and confirm by selecting OK.
 - Select a target memory location where to save the Style/Pad. The name of the Style/Pad already existing at the selected location is shown after the Bank-Location number.

Warning: If you select an existing Style/Pad and confirm writing, the older Style/Pad is deleted and replaced by the new one. Save the Styles/Pads you don’t want to lose to a storage device, before overwriting them.
18. Touch OK to save the Style/Pad to the internal memory, or Cancel to delete any changes made in Style/Pad Record mode. When the “Are you sure?” message appears, touch OK to confirm, or Cancel to go back to the “Write Style” or “Write Pad” dialog box.

Event Edit: Filter

This page is where you can select the event types to be shown in the Event Edit page.

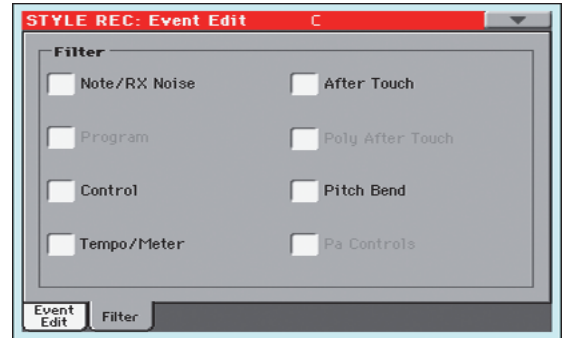

Turn On the filter for all event types you do not wish to see in the Event Edit page.

Note: Some of the events are “ghosted”, and non editable, since the corresponding events are not editable in a Style/Pad.

Note/RX Noise

Notes and RX Noises.

Control

Control Change events. Only the following Control Change numbers are allowed with Styles/Pads.

Control function	CC# (Control Change Number)
Modulation 1	1
Modulation 2	2
Pan	10
Expression ^(a)	11
CC#12	12
CC#13	13
Ribbon	16
Damper	64
Filter Resonance	71
Low Pass Filter Cutoff	74
CC#80	80
CC#81	81
CC#82	82

(a). Expression events cannot be inserted at the starting Position (001.01.000). An Expression value is already among the default “header” parameters of the Style Element or Pad Track.

Tempo/Meter Tempo and Meter (time signature) changes (Master Track only).

Pitch Bend Pitch Bend events.

Style/Pad Edit: Quantize

The quantize function may be used to correct any timing mistake after recording, or to give the pattern a “groovy” feeling.



After setting the various parameters, touch Execute.

Track

(Style only) Use this parameter to select a track.

All All tracks selected.

Drum...Acc5 Selected track.

E / CV (Style Element/Chord Variation)

Use these parameters to select the Style Element (Style only) and Chord Variation for editing.

Resolution

This parameter sets the quantization after recording. For example, when you select 1/8, all notes are moved to the nearest 1/8 division. When you select 1/4, all notes are moved to the nearest 1/4 division.

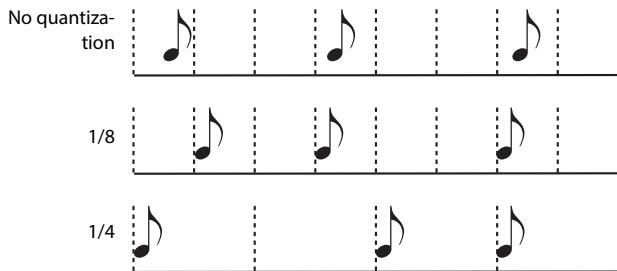

♩ (1/32)... ♩ (1/4)

Grid resolution, in musical values. A “b...f” character added after the value means swing-quantization. A “3” means triplet.

Start / End Tick

Use these parameters to set the starting and ending points of the range to quantize.

If a Chord Variation is four measures long, and you want to select it all, the Start will be positioned at 1.01.000, and the End at 5.01.000.

Bottom / Top Note

Use these parameters to set the bottom and top of the keyboard range to quantize. If you select the same note as the Bottom and

Top parameters, you can select a single percussive instrument in a Drum or Percussion track.

Note: These parameters are available only when a Drum or Percussion track is selected.

Execute

Touch this button to execute the operation set in this page.

Track status icon

Status of tracks. Touch this icon to change the status.



Play status. The track can be heard.



Mute status. The track cannot be heard.

Track names

Under the buttons, a label for each track is shown.

Style/Pad Edit: Transpose

In this page you can transpose the selected track(s).

Note: After transposing, please don't forget to readjust the “Key/Chord” parameter in the main page of the Style Record mode (see page 135).

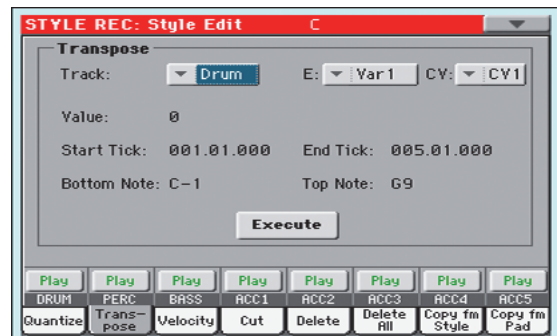

After setting the various parameters, touch Execute.

Track

(Style only) Use this parameter to select a track.

All All tracks selected, apart for tracks set in Drum mode (like the Drum and Percussion tracks). The whole selected Chord Variation will be transposed.

Drum...Acc5 Single selected track.

E / CV (Style Element/Chord Variation)

Use these parameters to select the Style Element (Style only) and Chord Variation for editing.

Value

Transpose value (±127 semitones).

Start / End Tick

Use these parameters to set the starting and ending points of the range to be transposed.

If a Chord Variation is four measures long, and you want to select it all, the Start will be positioned at 1.01.000, and the End at 5.01.000.

Bottom / Top Note



Use these parameters to set the bottom and top of the keyboard range to be transposed. If you select the same note as the Bottom and Top parameters, you can select a single percussive instrument in a Drum or Percussion track. Since in a Drum Kit each instrument is assigned to a different note of the scale, transposing a percussive instrument means assigning the part to a different instrument.

Execute

Touch this button to execute the operation set in this page.

Track status icon

Status of tracks. Touch this icon to change the status.

-  Play status. The track can be heard.
-  Mute status. The track cannot be heard.

Track names

Under the buttons, a label for each track is shown.

Style/Pad Edit: Velocity

In this page you can change the velocity (dynamics) value of notes in the selected track. An Advanced mode is available, allowing you to select a velocity curve for the selected range. This is useful to create fade-ins or fade-outs.

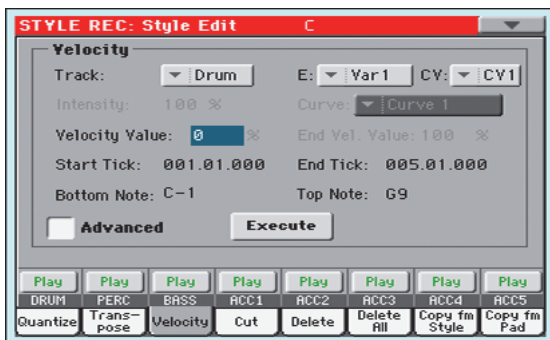

After setting the various parameters, touch Execute.

Note: When an RX Sound is assigned to the track being edited, the resulting sound may change, since this kind of Sounds is made of several different layers triggered by different velocity values.

Also, a fade-out may result in the level “jumping” up next to the zero, since a higher-level layer may be selected by low velocity values.

Track

(Style only) Use this parameter to select a track.

All All tracks selected. The velocity for all notes of the whole selected Chord Variation will be changed.

Drum...Acc5 Selected track.

E / CV (Style Element/Chord Variation)

Use these parameters to select the Style Element (Style only) and Chord Variation for editing.

Value

Velocity change value (± 127).

Start / End Tick

Use these parameters to set the starting and ending points of the range to be modified.

If a Chord Variation is four measures long, and you want to select it all, the Start will be positioned at 1.01.000, and the End at 5.01.000.

Bottom / Top Note

Use these parameters to set the bottom and top of the keyboard range to be modified. If you select the same note as the Bottom and Top parameters, you can select a single percussive instrument in a Drum or Percussion track.

Advanced

When this checkbox is checked, the “Intensity”, “Curve”, “Start Velocity Value” and “End Velocity Value” parameters can be edited.

Intensity

(Only available in Advanced mode). Use this parameter to specify the degree to which the velocity data will be adjusted toward the curve you specify in “Curve”.

0...100% Intensity value. With a setting of 0 [%], the velocity will not change. With a setting of 100 [%], the velocity will be changed the most.

Curve

(Only available in Advanced mode). Use this parameter to select one of the six curves, and to specify how the velocity will change over time.

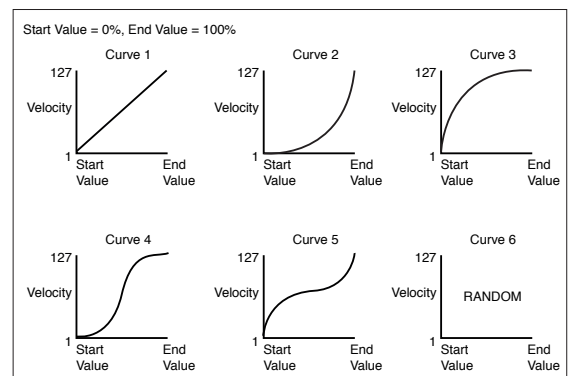

Start / End Vel. Value

(Only available in Advanced mode). Velocity change at the starting and ending ticks of the selected range.

0...100 Velocity change in percentage.

Execute

Touch this button to execute the operation set in this page.

Track status icon

Status of tracks. Touch this icon to change the status.

 Play status. The track can be heard.

 Mute status. The track cannot be heard.

Track names

Under the buttons, a label for each track is shown.

Style/Pad Edit: Cut

This function lets you quickly delete a selected measure (or a series of measures) from the selected Chord Variation. All following events are moved back, to replace the cut measure(s).

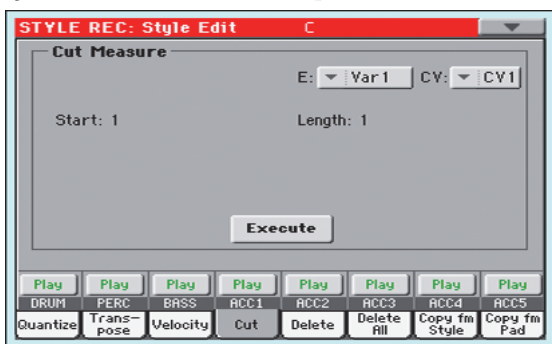

After setting the various parameters, touch Execute.

E / CV (Style Element/Chord Variation)

Use these parameters to select the Style Element (*Style only*) and Chord Variation for editing.

Start

First measure to be cut.

Length

Number of measures to be cut.

Execute

Touch this button to execute the operation set in this page.

Track status icon

Status of tracks. Touch this icon to change the status.

 Play status. The track can be heard.

 Mute status. The track cannot be heard.

Track names

Under the buttons, a label for each track is shown.

Style/Pad Edit: Delete

This page is where you can delete MIDI events out of the Style/Pad. This function does not remove measures from the pattern. To remove whole measure, use the Cut function (see "Style/Pad Edit: Cut" on page 150)



After setting the various parameters, touch Execute.

Track

(*Style only*) Use this parameter to select a track.

All All tracks selected. After deletion, the selected Chord Variation will remain empty.

Drum...Acc5 Selected track.

E / CV (Style Element/Chord Variation)

Use these parameters to select the Style Element (*Style only*) and Chord Variation for editing.

Event

Type of MIDI event to delete.

All All events. The measures are not removed from the Chord Variation.

Note All notes in the selected range.

Dup.Note All duplicate notes. When two notes with the same pitch are encountered on the same tick, the one with the lowest velocity is deleted.

After Touch After Touch events.

Pitch Bend Pitch Bend events.

Prog.Change Program Change events, excluding the bundled Control Change #00 (Bank Select MSB) and #32 (Bank Select LSB).

Note: This kind of data is automatically removed during recording.

Ctl.Change All Control Change events, for example Bank Select, Modulation, Damper, Soft Pedal...

CC00/32...CC127

Single Control Change events. Double Control Change numbers (like 00/32) are MSB/LSB bundles.

Note: Some CC data are automatically removed during recording. See the table on page 133 for more information on the allowed data.

Start / End Tick

Use these parameters to set the starting and ending points of the range to delete.

If a Chord Variation is four measures long, and you want to select it all, the Start will be positioned at 1.01.000, and the End at 5.01.000.

Bottom / Top Note

Use these parameters to set the bottom and top of the keyboard range to delete. If you select the same note as the Bottom and Top parameters, you can select a single percussive instrument in a Drum or Percussion track.



Note: These parameters are available only when the All or Note option is selected.

Execute

Touch this button to execute the operation set in this page.

Track status icon

Status of tracks. Touch this icon to change the status.

-  Play status. The track can be heard.
-  Mute status. The track cannot be heard.

Track names

Under the buttons, a label for each track is shown.

Style/Pad Edit: Delete All

This function lets you quickly delete a selected Style Element or Chord Variation, or the whole Style.

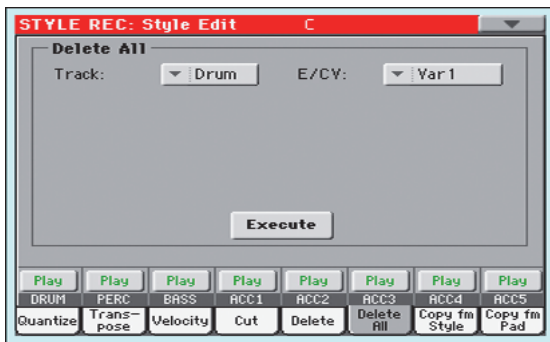

After setting the various parameters, touch Execute.

Track

(Style only) Use this parameter to select a track.

- All All tracks of the selected Style, Style Element or Chord Variation.
- Drum-Acc5 Single track of the selected Style, Style Element or Chord Variation.

E / CV (Style Element/Chord Variation)

Use these parameters to select the Style Element (Style only) and Chord Variation for editing.

- All All Style Elements, i.e. the whole Style. When E/Track=All and CV=All, the whole Style is deleted, and all parameters are set to the default status.

Var1...CountIn

Single Style Element.

V1-CV1...CI-CV2



Single Chord Variation.

Execute

Touch this button to execute the operation set in this page.

Track status icon

Status of tracks. Touch this icon to change the status.

-  Play status. The track can be heard.
-  Mute status. The track cannot be heard.

Track names

Under the buttons, a label for each track is shown.

Style/Pad Edit: Copy from Style

Here you can copy a track, Chord Variation or Style Element inside the same Style, or from a different one. Furthermore, you can copy a whole Style.

Warning: The Copy operation deletes all data at the target location (overwrite).



After setting the various parameters, touch Execute.

Note: If you copy too many events on the same tick, the "Too many events!" message appears, and the copy operation is aborted.

Note: When you copy over an existing Chord Variation, Program Change data is not copied, to leave the original Sounds unchanged for that Chord Variation.

From Style

Choose this option to select the source Style to copy the track, Chord Variation or Style Element from. Touch the **Select** button to open the Style Select window and select the source Style.

From... To E/CV (Style Element/Chord Variation)

Use these parameters to select the source and target Style Elements or Chord Variations.

Note: You can't copy from a Variation to a different Style Element (or vice-versa), because of their different structure.

- All All Style Elements, i.e. the whole Style. You can't change the target, that is automatically set to All.
- Var1...End2 Single Style Element.
- V1-CV1...E2-CV2 Single Chord Variation.

From... To Track

Use this parameter to select the source and target track to copy. You can double a track, to strengthen a pattern.



- All All tracks of the selected Style, Style Element or Chord Variation.
- Drum-Acc5 Single track of the selected Style, Style Element or Chord Variation.

Execute

Touch this button to execute the operation set in this page.

Track status icon

Status of tracks. Touch this icon to change the status.

-  Play status. The track can be heard.
-  Mute status. The track cannot be heard.

Track names

Under the buttons, a label for each track is shown.

Copying to a Chord Variation of a different length

You can copy a Chord Variation to a different one of a different length. Just keep in mind the following:

- If the source length is a divider of the target length, the source Chord Variation will be multiplied to fit the target Chord Variation. For example, if the source is 4-measures long, and the target 8-measures, the source will be copied two times.

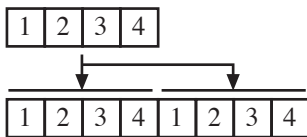

- If the source length is not a divider of the target length, the source Chord Variation will be copied for as many measures as can fit the target Chord Variation. For example, if the source is 6-measures long, and the target 8-measures, the source will be copied once, then the first 2 measures will be copied to fit the remaining 2 measures.

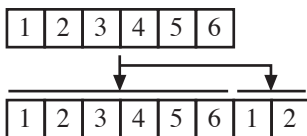

Note: Avoid copying to a Chord Variation with a different meter (time signature), for example a 4/4 Chord Variation onto a 3/4 one.

Style/Pad Edit: Copy from Pad

Here you can copy a Chord Variation from a Pad. Furthermore, you can copy a whole Pad.

Warning: The Copy operation deletes all data at the target location (overwrite).



After setting the various parameters, touch Execute.

Note: If you copy too many events on the same "tick", the "Too many events!" message appears, and the copy operation is aborted.

Note: When you copy over an existing Chord Variation, Program Change data is not copied, to leave the original Sounds unchanged for that Chord Variation.

From Pad

Choose this option to select the source Pad to copy the Chord Variation from. Touch the **Select** button to open the Pad Select window and select the source Pad.

From CV (Chord Variation)

Use this parameter to select the source Chord Variation.

- All All Chord Variations, i.e. the whole Pad. You can't change the target, that is automatically set to All.
- CV1...CV6 Single Chord Variation.

To CV (Chord Variation)

Use this parameter to select a target Chord Variation inside the current Style/Pad.

- CV1...CV6 Target Chord Variation. Automatically set to All if the "From CV" parameter is also set to All.

To Track

(Style only) Use this parameter to select the target track to copy.

- All All tracks of the selected Style, Style Element or Chord Variation.
- Drum-Acc5 Single track of the selected Style, Style Element or Chord Variation.

Execute

Touch this button to execute the operation set in this page.

Style Element Track Controls: Sound/Expression

In this page you can assign a different Sound to each track of the selected Style Element. Each Style Element can have different Sound; after saving the new Style, please don't forget to check the "Original Style Sounds" parameter in the Style Play mode (see page 110), to let the Style select the Sound bypassing the Style Settings.

In this page you can also check and modify the Expression (CC#11) value for each of the Style Element tracks. This lets you reduce the relative level of a track in a single Style Element, without reducing the overall Volume of the Style. This is a very useful control, when you have different Sounds assigned to the same track in different Style Elements, and the internal level of these Sounds must be different.



When in this page, press the corresponding button on the control panel to select a Style Element (VARIATION1 ... ENDING3).

To copy the settings of this page to another Style Element, use the "Copy Sound" and "Copy Expression" commands from the page menu (see "Copy Sounds dialog box" and "Copy Expression dialog box" starting from page 162).

Selected Track Info area

See "Selected track info area" on page 135 for detailed information.

Sounds area

See "Sounds area" on page 137 for detailed information.

Expression area

Expression Monitor

You can use these indicators to check if CC#11 (Expression) messages are contained in a track. Expression messages contained in a track can vary the volume of the track. It is very difficult to catch them out – unless you carefully read all the events in the Event Edit page.

This monitor should help you keeping track of them, and let you access Event Edit only on the tracks containing the messages. Press the START/STOP button to start playback, and look at the indicators. When one of them lights up, you can enter Event Edit on the corresponding track, and edit or remove the Expression messages.

Expression

Use these knobs to set the Expression (CC#11) value for the corresponding track. This value can be seen at the beginning of the Event Edit list (see "Event Edit: Event Edit" on page 145).

Different Expression values can be defined for each Style Element. This way, you can set a different volume in each Style Element, relative to the general Volume value set in the Style Header.

Expression leveling

You can quickly and easily adjust the Expression level of all tracks in a Style Element (Variation, Intro...). This allows for a more precise control over the volume level of all Style Element.

1. While in this page, select one of the Style Elements by pressing its button in the control panel.

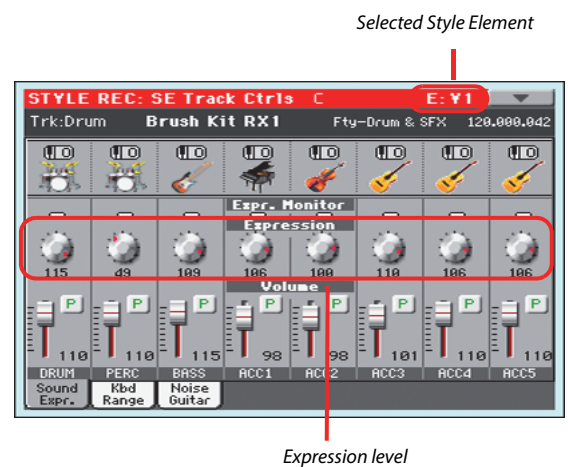

2. Keep the SHIFT button pressed, and press the TEMPO+ button to increase the Expression value of all the Style Variation's tracks, TEMPO- to decrease it.
3. Release the SHIFT button.
4. Repeat the above operation with all the desired Style Elements.

Note: A track's volume may be changed by an Expression event contained in a track. To check if any of these events exist in a track, let the Style Element play and look at the Expression Monitor in this same page. If one or more Expression events are found, go to the Event Edit page and delete it (or them)

Volume area

Use these controls to set the volume and status of each track. See page 137 for more information.

The Volume value is the same for the whole Style. Use the Expression controls to adjust the relative balance between tracks in each Style Element.

Style Element Track Controls: Keyboard Range

The Keyboard Range automatically transposes any pattern note that would otherwise play too high or too low in pitch, compared to the original acoustic instrument, when transposed by the arranger. This will result in a more natural sound for each accompaniment instrument.

For example, the lower limit for a guitar is E2. If you play a chord under the E2, the transposed pattern could exceed this limit, and sound unnatural. A Bottom limit set to E2 for the guitar track will solve the problem.

Different Keyboard Range values can be set for each Style Element.



Note: The Keyboard Range is ignored while recording. The selected track can be recorded and played back on the full range of the keyboard.

When in this page, press the corresponding button on the control panel to select a Style Element (VARIATION1 ... ENDING3).

To copy the settings of this page to another Style Element, use the “Copy Keyboard Range” command from the page menu (see “Copy Key Range dialog box” on page 163).

Top/Bottom

Use these parameters to set the bottom and top of the keyboard range for the corresponding track of the current Style Element.

Volume area

Use these controls to set the volume and status of each track. See page 137 for more information.

Style Element Track Controls: Noise/Guitar

The Noise/Guitar page is where you can set the RX Noise level and the ‘human feel’ of Guitar tracks.



RX Noise

Use these controls to adjust the volume of RX Noises in the corresponding tracks. This control applies to all types of tracks (provided the Sound includes RX Noises).

Humanize GTR

Use these controls to apply a random value to the position, velocity and length of notes of Guitar tracks (see “Track Type” on page 156). This control has no effect on other types of track.

Pad Track Controls: Sound/Expression

In this page you can assign a Sound to the Pad track, adjust its Volume (CC#07) and Expression (CC#11) values, and set various other parameters, like the Keyboard Range, Track Type, Trigger Mode, Tension and Wrap Around.



Sound/Bank

Sound assigned to the Pad track.

Volume

Use this slider to set the Volume (CC#07) value for the Pad track. This value is not saved with the Pad, and is only used to test the Pad's volume during editing or recording.

Pad Type

Use this parameter to decide if the Pad will play once or if it will loop.

Note: While in Pad Record mode, the pattern is always played back in loop, even if this parameter is set to "One Shot".

One Shot When you press one of the PAD buttons, the corresponding Pad is only played once. This is useful for playing Hits or Sequences that must only play once.

Loop When you press one of the PAD buttons, the corresponding Pad plays up to the end, then continues playing from the start. Press STOP in the PAD section to stop it playing. This is useful for playing cyclic sequences.

Keyboard Range

The Keyboard Range automatically transposes any pattern note that would otherwise play too high or too low in pitch, compared to the original acoustic instrument, when transposed by the arranger. This will result in a more natural sound for the Pad instrument.

Note: The Keyboard Range is ignored while recording. The Pad track can play on the full range of the keyboard.

Trigger Mode

(Not available if Track Type = Drum). This setting lets you define how Bass and Acc-type tracks are retriggered when the chord is changed.

Off Each time you play a new chord, current notes will be stopped. The track will remain silent until a new note will be encountered in the pattern.

Rt (Retrigger) The sound will be stopped, and new notes matching the recognized chord will be played back.

Rp (Repitch) New notes matching the recognized chord will be played back, by repitching notes already playing. There will be no break in the sound. This is very useful on Guitar and Bass tracks.

Track Type

Use this parameter to set the type of the Pad track.

Drum Drum track. This type of track is not transposed by the arranger, and is used for Drum Kits, or for tracks that you don't want to be transposed when playing a different chord.

Bass Bass track. This type of track always plays the root when changing chord.

Acc Accompaniment track. This type of track can be used freely, for melodic or harmonic accompaniment patterns.

Expression

Use this knob to set the Expression (CC#11) value for the Pad track. This value can be seen at the beginning of the Event Edit list.

The Expression is useful to balance the Pad with the other Pads. For example, if you want the Pad you are recording to be mel-lower than the average, just lower the Expression value.

Tension

Tension adds notes (a 9th, 11th and/or 13th) that have actually been played, even if they haven't been written in the Pad pattern. This parameter specifies whether or not the Tension included in the recognized chord will be added to an Acc-type track.

On The Tension will be added.

Off No Tension will be added.

RX Noise

Use these controls to adjust the volume of RX Noises in the corresponding tracks. This control applies to all types of tracks (provided the Sound includes RX Noises).

Humanize GTR

Use these controls to apply a random value to the position, velocity and length of notes of Guitar tracks (see "Track Type" on page 155). This control has no effect on other types of track.

Wrap Around

The wrap-around point is the highest register limit for the Pad track. The Pad pattern will be transposed according to the detected chord. If the chord is too high, the Pad track might play in a register that is too high, and therefore unnatural. If, however, it reaches the wrap-around point, it will be automatically transposed an octave lower.

The wrap-around point can be individually set in semitone steps up to a maximum of 12 semitones, relative to the chord root set in the main page of the Pad Record mode (see "Key/Chord" on page 135).

1...12 Maximum transposition (in semitones) of the track, referred to the original key of the Pad pattern.

Style Element/Pad Chord Table: Chord Table

This is the page where you can assign a Chord Variation to each of the most important recognized chord. When a chord is recognized, the assigned Chord Variation will be automatically selected by the arranger to play the accompaniment.

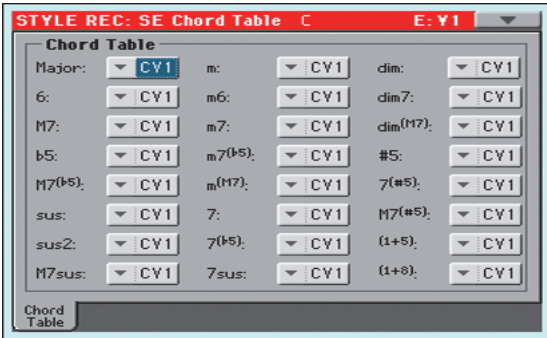

When in this page, press the corresponding button on the control panel to select a Style Element (VARIATION1 ... ENDING3).

Chord / Chord Variation

Use these parameters to assign a Chord Variation to each of the most important chords.

Style Track Controls: Type/Trigger/Tension

In this page you can set the Mode, Trigger mode for the Style tracks, and activate/deactivate the Tension for the Accompaniment tracks.



When in this page, press the corresponding button on the control panel to select a Style Element (VARIATION1 ... ENDING3).

Track Type

Use this parameter to set the type of the corresponding track.

- Drum** Drum track. This type of track is not transposed by the arranger, and is used for Drum Kits made of Drum sounds. It can be affected by the Drum Mapping of the Style Play mode (see "Drum Mapping (Var.1...Var.4)" on page 126).
- Perc** Percussion track. This type of track cannot be transposed, and is used for Drum Kit made of Percussion sounds. It is NOT affected by the Drum Mapping.
- Bass** Bass track. This type of track always plays the root when changing chord.
- Acc** Accompaniment track. This type of track can be used freely, for melodic or harmonic accompaniment patterns.
- Gtr** Guitar track. This type of track uses Guitar Mode to create guitar strumming (see "Main page - Guitar Mode" on page 138). When this type is selected, the "Tension" parameter can no longer be edited.

Trigger Mode

This setting lets you define how Bass and Acc-type tracks are retriggered when the chord is changed.

- Off** Each time you play a new chord, current notes will be stopped. The track will remain silent until a new note will be encountered in the pattern.
- Rt** (Retrigger) The sound will be stopped, and new notes matching the recognized chord will be played back.
- Rp** (Repitch) New notes matching the recognized chord will be played back, by repitching notes already playing. There will be no break in the sound. This is very useful on Guitar and Bass tracks.

Tension

Tension adds notes (a 9th, 11th and/or 13th) that have actually been played to the accompaniment, even if they haven't been written in the Style pattern. This parameter specifies whether or not the Tension included in the recognized chord will be added to the Acc-type tracks.

- On** The Tension will be added.
- Off** No Tension will be added.

Import: Import Groove

The Import Groove function allows the loading of MIDI Grooves (".GRV" files). By importing these data to a track, and assigning the Sound based on the sliced samples to the same track, you can play the original audio groove, and freely change its Tempo.

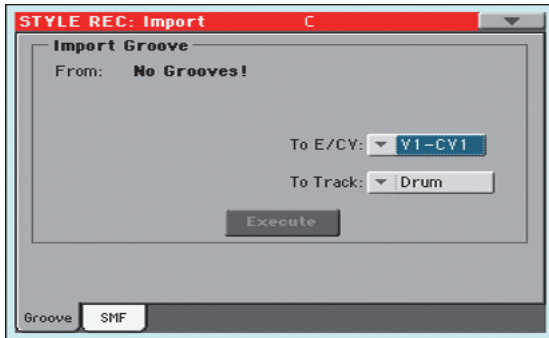

Note: After importing a groove generated by a melody line (not by a percussive groove), the imported groove and samples will not be transposed together with the other Style tracks. Audio data cannot be transposed by the arranger.

Note: Please execute the Import Groove operation before setting the instrument to standby. All ".GRV" files generated by a Time Slice operation are deleted when the instrument enters standby.

From

Use this parameter to select one of the MIDI Groove patterns (".GRV" files) generated when saving data after a Time Slice operation.

To E/CV (Style Element/Chord Variation)

Use this parameter to select the target Style Element (Style only) and Chord Variation.

To Track

(Style only) Use this parameter to select the target track inside the selected Chord Variation. **The Percussion track is usually suggested**, since the Drum track is still suitable for standard Drum Kit sounds (count-in, break etc.). After importing the MIDI Groove pattern, assign the Sound, to which the sliced samples are assigned, to the track playing the MIDI Groove pattern.

Import: Import SMF

The Import SMF function allows you to import MIDI data from a Standard MIDI File (SMF) created on your preferred external sequencer, and transform them in a Chord Variation.

Note: You cannot use this function to import data from any generic Song. The Standard MIDI File to be imported must be programmed as if it was one of Pa900's Chord Variations.

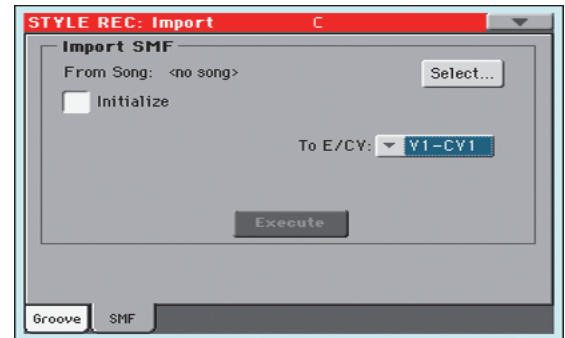

When importing an SMF, parameters like CV Length, Meter, Tempo Changes, Program Changes and Expression are recognized. These parameters will be imported as the header of the Style Element containing the Chord Variation, provided the "Initialize" parameter is checked, or the Style Element is empty.

Hint: It is a good idea to check the "Initialize" parameter when importing the first Chord Variation of a Style Element, and uncheck it when importing the following Chord Variations.

- Sounds assigned to each track can be imported, provided the Program Change, Bank Select MSB and LSB events are on the first 'tick' of the SMF. These data are loaded in the Style Element's header, and not as Sounds assigned to the Style Performance.

Note: Sounds in the Style Element header can be overridden by Sounds assigned to the Style Settings, by checking the "Original Style Sound" parameter in the main page of the Style Play mode (Style Track view).

- If the above data was not found on the first tick of the imported SMF, Sounds must be manually assigned to each track. You can do this in the "Record 1" or "Record 2", or the "Sound/Expression" page of the Style Record mode.

- Key/Chord, Chord Table, Expression, and any other Style Variation parameter, must be manually programmed in the relevant Style Record pages.

- The starting Tempo, and each track's Volume, must be programmed as Style Settings data, and then saved in the Style Settings.

- Meter (time signature) Change is not allowed, therefore not recognized.

- The Chord Variation length is the same as the imported SMF. You can change length by changing the value of the CV Length parameter, on the main page of the Style/Pad Record mode.

Hint: If a note extends beyond the last measure of the Chord Variation, an additional measure is appended (for example, if a note extends after the end of the fourth measure in a 4-measure pattern, a 5-measure Chord Variation will be generated). If so, change the CV Length value to reset the Chord Variation length. The exceeding note will be cut, to fit the new pattern length.

When programming a Chord Variation on an external sequencer, please assign each Style track to the correct MIDI channel, according to the following table.

Style Track	MIDI Channel
Bass	09
Drum/Pad	10
Percussion	11
Accompaniment 1	12
Accompaniment 2	13
Accompaniment 3	14
Accompaniment 4	15
Accompaniment 5	16

When programming a Chord Variation on the external sequencer, please assign the Pad track to the MIDI channel #10.

Note: Only SMF in format 0 can be loaded.

From Song

This is the name of the Standard MIDI File to be loaded. Touch the Select button to open the file selector, and select an “.SMF” file.

Select

Touch this button to open the file selector and load the SMF.

Initialize

Check this parameter if you want all settings of the target Style Element (i.e., Key/Chord, Chord Table, Sounds...) are reset when loading the SMF.

Hint: It is a good idea to check the “Initialize” parameter when importing the first Chord Variation of a Style Element, and uncheck it when importing the following Chord Variations.

To E/CV

Use this parameter to select a target Chord Variation.

Execute

After setting all parameters in this page, touch this button to import the Standard MIDI File into the target Chord Variation.

Importing an SMF separated by Markers into a Style

As an alternative to importing single Chord Variations, you can import a whole Style as an SMF separated by Markers, i.e., a single SMF containing all the Chord Variations (Variation 1, Variation 2, etc.) each one separated by a Marker (the same events used in Song Play mode).

1. While in this page, touch the Select button, and choose the Standard Midi File to be imported.
2. Keep the SHIFT button pressed.
3. Without releasing the SHIFT button, touch the Execute button in the display.
4. Release the SHIFT button.

When creating a new Style, we suggest to check the “Initialize” checkbox. Do not check it if the SMF you are loading was previously exported from a Style to be edited; in this case, it is very important to keep all the previous settings.

Style Tracks and MIDI Channels must be lined as in the previous table, as per Korg’s standard Style format definition.

Note: Tracks/MIDI Channels other than the above mentioned are ignored during the import procedure.

For a list of MIDI events supported during the import operations, please see “List of recorded events” on page 133. If any, the following events are stripped off and automatically transferred to the Style Element header during the import procedure:

- Time signature (this event is mandatory)
- Control Change bundle #00-32 (Bank Select MSB/LSB)
- Program Change
- Control Change #11 (Expression)

Control Change 00, Control Change 32 and Program Change messages must be placed at the very beginning of each Chord Variation (tick 0).

Whenever they are not saved in the SMF, Program Change, Control Change 00, 11 and 32, can be still programmed in Style Record mode, by using the edit features available.

Warning: Pa900 can only handle SMF format 0 (Zero). If you are in trouble importing your file, maybe your sequencer (or DAW) is exporting using SMF format 1. Please refer to the software's user's manual.

The naming structure for the Markers inside the SMF is "EnCVn", whose single components are shown in the following table:

Component	Meaning
E	Style Element ('v' = variation, 'i' = intro, 'f' = fill, 'e' = ending)
n	Style Element number ('1'~'4' for variations, '1'~'2' for all other style elements)
CV	Chord Variation ('cv' = chord variation – no other choices allowed)
n	Chord Variation number [1~6 for Variations, 1~2 for all others]

Warning: It is mandatory not to use capital letters in Marker names. Some examples of **valid** names:

'i1cv2' = Intro 1 – Chord Variation 2

'v4cv3' = Variation 4 – Chord Variation 3

Examples of **non accepted** names:

'V1cv2', 'v1CV2', 'intro i1cv2', 'v1cv1 chorus'

The order of the Chord Variations inside the SMF is not relevant. They can be freely placed inside the SMF.

At the end of this page you can find a screenshot of a test file created in Steinberg Cubase, just as an example of how a SMF separated by Markers can look like. Considering analogies between actual workstations, it will not look much different in other applications like Logic, Digital Performer, Pro Tools or Sonar.

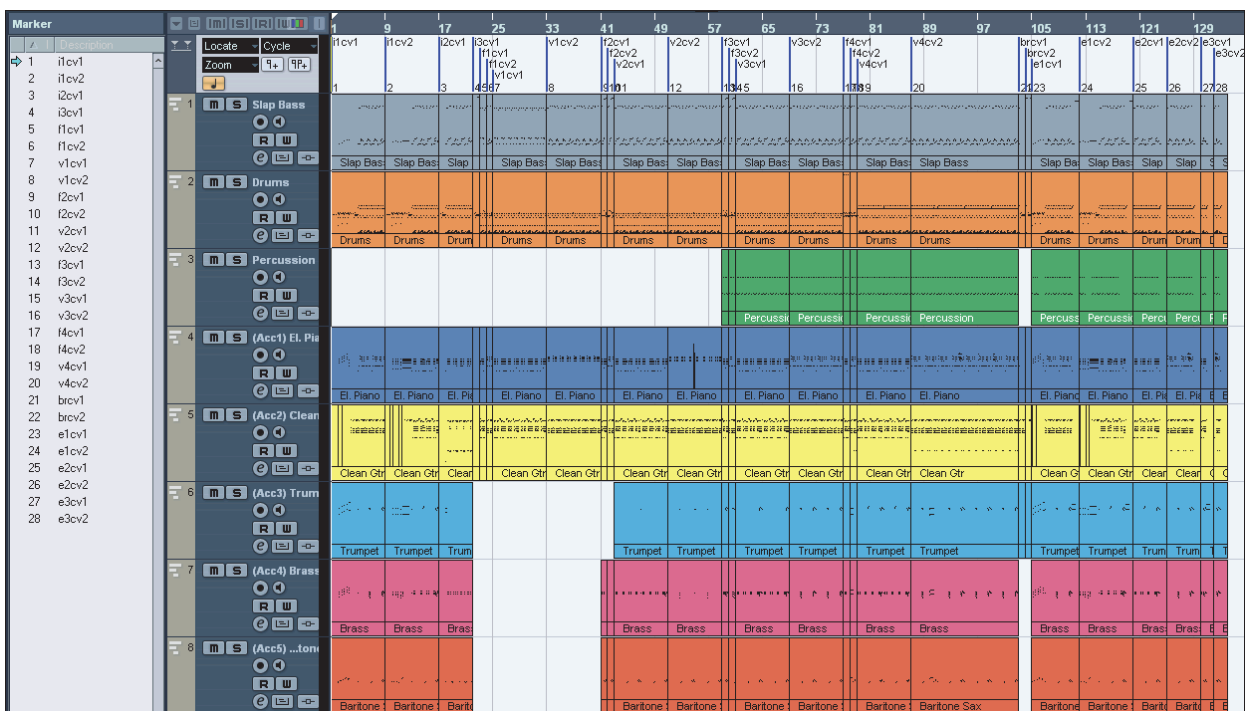

Export SMF

The Export SMF function allows you to export a Chord Variation as a Standard MIDI File (SMF), and edit it on your preferred external sequencer.

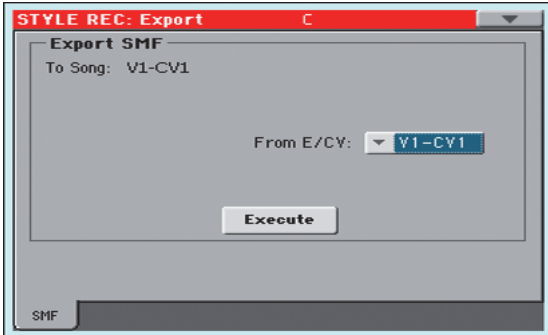

To Song

This (non editable) parameter shows the name of the Standard MIDI File to be generated. The (automatically assigned) name will be the same of the exported Chord Variation.

From E/CV

Use this pop-up menu to select one of the available Chord Variations from the current Style.

Execute

After selecting a Chord Variation, touch this button to export it as a Standard MIDI File. A standard file selector will appear. Select the target device and directory, then touch Save. After you touch Save, a dialog box appears, letting you assign a name to the file.

Exporting a Style as an SMF separated by Markers

As an alternative to exporting single Chord Variations to individual Standard MIDI Files, you can export a whole Style as an *SMF separated by Markers*, i.e., a single SMF containing all the Chord Variations (Variation 1, Variation 2, etc.) each one separated by a Marker (the same events used in Song Play mode).

1. While in this page, keep the SHIFT button pressed.
2. Without releasing the SHIFT button, touch the Execute button in the display.
3. Release the SHIFT button.
4. Assign a name to the Standard Midi File where to save the Style in edit.

This operation creates, in the selected device, an SMF format 0 (Zero), containing all the MIDI data included in the selected Style, with each Chord Variation starting from a different Marker (named as per the naming convention explained in the Import section above).

Each Chord Variation will include, at the very beginning (tick 0), the following informations:

- Time signature
- Control Change bundle #00-32 (Bank Select MSB/LSB)
- Program Change
- Control Change #11 (Expression)

Page menu

Touch the page menu icon to open the page menu. Touch a command to select it. Touch anywhere in the display to close the menu without selecting a command.

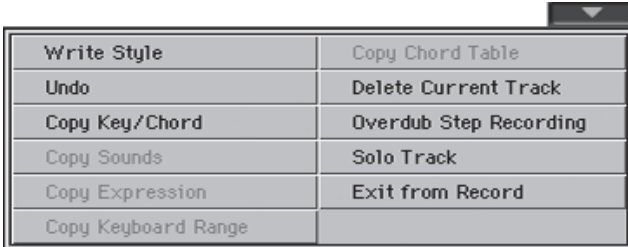

Style Record

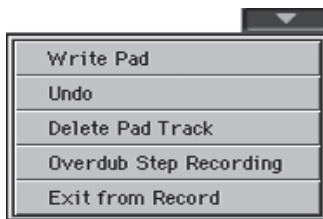

Pad Record

Write Style/Pad

Select this command to open the Write Style or Write Pad dialog box, and save the Style/Pad to the internal memory.

See “Write Style/Pad dialog box” on page 162 for more information.

Undo

Only available in Record mode. While in Record mode, cancels the latest recorded data and restores the previous situation. Selected a second time, it restores recorded data again (“Redo” function).

Delete Pad Track

Only available in the Main page of the Pad Record mode. Select this command to delete the Pad track.

Copy Key/Ch (Copy Key/Chord) button

Select this command to open the Copy Key/Chord dialog box, and copy Key/Chord settings of the currently selected track to all other tracks of the same Chord Variation, or to the whole Style.

See “Copy Key/Chord dialog box” on page 162 for more information.

Copy Sound

(Only available in some edit pages). While the Style Element Track Control edit section is selected, use this command to open the Copy Sound dialog box and copy all Sounds assigned to the current Style Element tracks to a different Style Element.

See “Copy Sounds dialog box” on page 162 for more information.

Copy Expression

(Only available in some edit pages). While the Style Element Track Control edit section is selected, use this command to open the Copy Expression dialog box and copy all Expression values assigned to the current Style Element tracks to a different Style Element.

See “Copy Expression dialog box” on page 163 for more information.

Copy Keyboard Range

(Only available in some edit pages). While the Style Element Track Control edit section is selected, use this command to open the Copy Keyboard Range dialog box and copy all Keyboard Range values for the current Style Element tracks to a different Style Element.

See “Copy Key Range dialog box” on page 163 for more information.

Copy Chord Table

Only available while in the Style Element Chord Table page. Select this command to open the Copy Chord Table dialog box (see “Copy Chord Table dialog box” on page 163).

Delete Current Track

(Only available in the Main Record pages). Select this command to delete the selected track.

Overdub Step Recording

(Only available in the Main Record pages). Select this command to open the Overdub Step recording window (see “Overdub Step Recording window” on page 164).

Solo Track

Select the track to be soloed, then check this item. You will hear only the selected track, and the ‘Solo’ warning will flash on the page header.

Uncheck this item to exit the Solo function.

(SHIFT) Keep the SHIFT button pressed and touch one of the tracks to solo it. Do the same on a soloed track to deactivate the Solo function.

Exit from Record

Select this command to exit from Record without saving changes to the Style.

Write Style/Pad dialog box

Open this window by choosing the Write Style or Write Pad item from the page menu. Here you can save the recorded or edited Style/Pad to memory.

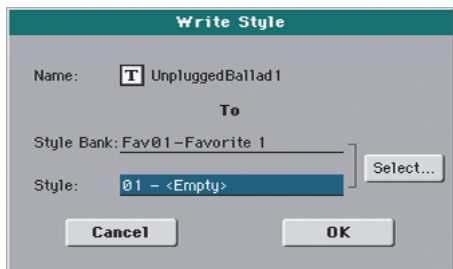

Name

Name of the Style/Pad to be saved. Touch the **T** (Text Edit) button next to the name to open the Text Edit window.

Style/Pad Bank

Target bank of Styles/Pad. Use the Select button on the display, or the VALUE DIAL to select a different bank.

Style

Target Style/Pad location in the selected bank. Use the Select button on the display, or the VALUE DIAL to select a different location.

Note: A User or Favorite Style, or a User Pad, is usually prompted when writing a Style/Pad. However, you can overwrite a Factory Style/Pad when the “Factory Style and Pad Protect” parameter is left unchecked (see page 254).

Select... button

Touch this button to open the Style/Pad Select window, and select a target location.

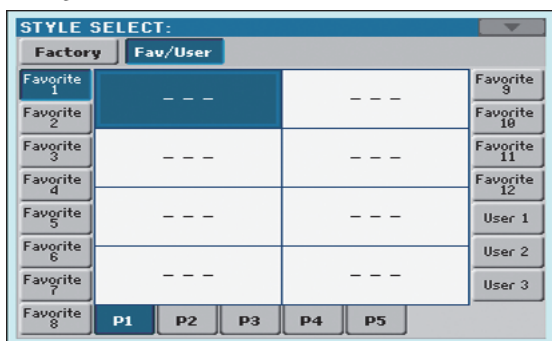

While in the Style/Pad Select window, use the buttons on top of the window to select either the User or the Favorite banks.

Copy Key/Chord dialog box

(Style only) Open this window by choosing the Copy Key/Chord item from the page menu. Here you can copy Key/Chord settings of the currently selected track to all other tracks of the same Chord Variation, or to the whole Style. This function is useful to speed-up pattern programming, and to avoid having different tracks in different keys within the same Chord Variation.



Current Chord Variation Tracks

The Key/Chord of the current track will be copied to all tracks of the current Chord Variation.

All Style Tracks

The Key/Chord of the current track will be copied to all tracks of the Style (i.e., all Chord Variations).

Copy Sounds dialog box

(Style only) Open this window by choosing the Copy Sounds item from the page menu. Here you can copy all Sounds assigned to the current Style Element tracks to a different Style Element.



From Style Element

Non editable. Currently selected Style Element.

To Style Element

Target Style Element.

All Settings will be copied to all Style Element of the Style in edit.

Var1...CountIn

Single Style Element where to copy settings to.

Copy Expression dialog box

(*Style only*) Open this window by choosing the Copy Expression item from the page menu. Here you can copy all Expression values assigned to the current Style Element tracks to a different Style Element.

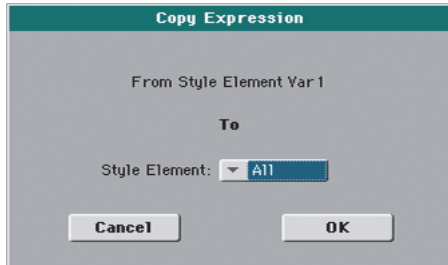

From Style Element

Non editable. Currently selected Style Element.

To Style Element

Target Style Element.

All Settings will be copied to all Style Element of the Style in edit.

Var1...CountIn

Single Style Element where to copy settings to.

Copy Chord Table dialog box

(*Style only*) Open this window by choosing the Copy Chord Table item from the page menu. Here you can copy the Chord Table of the current Style Element to a different Style Element.



To Style Element

Target Style Element.

All Settings will be copied to all Style Element of the Style in edit.

Var1...CountIn

Single Style Element where to copy settings to.

Copy Key Range dialog box

(*Style only*) Open this window by choosing the Copy Keyboard Range item from the page menu. Here you can copy all Keyboard Range values for the current Style Element tracks to a different Style Element.



From Style Element

Non editable. Currently selected Style Element.

To Style Element

Target Style Element.

All Settings will be copied to all Style Element of the Style in edit.

Var1...CountIn

Single Style Element where to copy settings to.

Overdub Step Recording window

The Step Record allows you to create a new Style/Pad by entering single notes or chords to each track, by playing them on the keyboard one at a time, with no need to play on time. This is very useful when transcribing an existing score, or needing a higher grade of detail, and is particularly suitable to create drum and percussion tracks.

To access this page, select the “Overdub Step Recording” command from the page menu.



Track (Selected track)

Name of the selected track in record.

DRUM...ACC5

Style track.

SE (Selected Style Element)

See “Element (Style Element)” on page 134.

CV (Selected Chord Variation)

See “Chord Var (Chord Variation)” on page 134.

Pos (Position)

This is the position of the event (note, rest or chord) to be inserted.

Event list

Previously inserted events. You may delete this event, and set it in edit again, by touching the Back button.

Step Time values

Length of the event to be inserted.

♩ ... ♯ Note value.

Standard (-) Standard value of the selected note.

Dot (.) Augments the selected note by one half of its value.

Triplet (3) Triplet value of the selected note.

Meter

Meter (time signature) of the current measure. This parameter cannot be edited. You can set the Meter in the main page of the Style Record mode, before actually starting recording (see step 6 on page 142 for more information).

Free Memory

Remaining memory for recording.

Duration

Relative duration of the inserted note. The percentage is always referred to the step value.

25% Staccatissimo.

50% Staccato.

85% Ordinary articulation.

100% Legato.

Velocity

Set this parameter before entering a note or chord. This will be the playing strength (i.e., velocity value) of the event to be inserted.

Kbd Keyboard. You can select this parameter, by turning all counter-clockwise the dial. When this option is selected, the playing strength of the played note is recognized and recorded.

1...127 Velocity value. The event will be inserted with this velocity value, and the actual playing strength of the note played on the keyboard will be ignored.

Rest

Touch this button to insert a rest.

Tie

Touch this button to tie the note to be inserted to the previous note.

Back

Goes to the previous step, erasing the inserted event.

Next M. (Next Measure)

Goes to the next measure, and fills the remaining space with rests.

Done

Exits the Step Record mode. If you have inserted some notes, a dialog box appears, asking you to either cancel, discard or save the changes.



If you touch Cancel, exit is canceled, and you can continue editing. If you choose No, changes are not saved, and the Step Record window is closed. If you choose Yes, changes are saved, and the Step Record window is closed.

Song Play mode

The Song Play operating mode is where you can listen to Songs, while reading Lyrics and Chords (where available). An automatically-generated Score can also be seen for Standard MIDI Files, and Markers can let you quickly jump to a Song section. You can mix two Songs by using the X-FADER.

Songs can be in Standard MIDI File, Karaoke™ or MP3 format. The MP3+G format is also supported.

You can play along with the Song with up to four Keyboard tracks (Upper 1-3, Lower) and four Pads. You can select different Sounds and Effects for Keyboard tracks by selecting Performances and STSs.

While in Song Play mode, you can use the SongBook to automatically select Songs for a desired music genre. With each Song entry in the SongBook, up to four STSs are also selected.

Song Play mode can also be used in Easy Mode.

Transport controls

You can use a separate set of transport controls for each of the two onboard players. Use the PLAYER 1 controls for Player 1, and PLAYER 2 controls for Player 2.

If you want both players to play together, keep the SHIFT button pressed and press one of the ►/■ (PLAY/STOP) controls to make both players start in sync.

If one of the players is already playing, you can start the other player by pressing the other ►/■ (PLAY/STOP) control; the second player will start at the next measure.

The two players' Tempo value is linked together. The Tempo data written into the Songs are ignored. Adjust the Tempo using the TEMPO buttons.

MIDI Clock

In Song Play mode the MIDI Clock is always generated by the internal Player 1, even if the Clock parameter is set to MIDI or USB mode in the Global > MIDI > General Controls page (see "Clock Source" on page 259). While in this mode, Pa900 cannot receive MIDI Clock messages from the MIDI IN.

Pa900 only transmits to the MIDI OUT and USB port the MIDI Clock messages generated by Player 1. For MIDI Clock messages to be sent, the "Clock Send" parameter must be activated in the Global > MIDI > General Controls page (see "Clock Send" on page 258).

Tempo Lock

If you don't want the Tempo value to change when selecting a new Song, turn on the Tempo Lock function by using the TEMPO LOCK buttons on the control panel. When this button's LED is turned on, you can still manually change the Tempo with the TEMPO +/- buttons, or by touching the Tempo field and using the VALUE DIAL.

Master Volume, Balance, X-Fader

While the MASTER VOLUME knob controls the general volume of the instrument, you can use the BALANCE knob to balance the Song and Pad tracks against the Keyboard tracks.

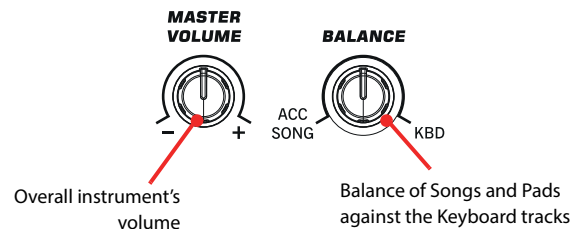

Use the X-FADER to mix between Player 1 and Player 2. Move it to the center for the maximum volume of both players.



Note: When this slider is fully moved to the right or the left, different Lyrics, Chords, Score and Markers can be shown, and a different can be selected.

Track parameters

Changes to Keyboard tracks can be saved to a Performance. You can then recall different settings by just selecting a single Performance.

Settings for Song tracks, like Pan, Volume and FX Sends, depend on each individual Standard MIDI File. Changes to Song tracks made in Song Play mode cannot be saved to a Standard MIDI File, and are only intended for realtime control.

To make permanent changes Song tracks, edit and save the Standard MIDI File in Sequencer mode.

Standard MIDI Files and Sounds

The native Song file format of Pa900 is the Standard MIDI File (SMF), an universal standard set by all manufacturers. Filename extension is .MID, but Pa900 can also read files with the .KAR extension. You can read these files with any musical instrument or computer.

Even if the Standard MIDI File format is standard, differences may appear in sounds when playing the various files. If you recorded a Song on the Pa900 in Sequencer mode using only General MIDI sounds (i.e., those of the “GM” type), you can be confident you can play the same Song on virtually any other musical instrument or computer. If you used Korg native sounds, you may not find the same sounds on instruments from other manufacturers.

When you read Standard MIDI Files in Song Play mode, there is no problem reading files made using only General MIDI sounds. Sounds could be different when playing a Song made on a different instrument: despite the wide compatibility of Pa900 with other standards (like GS or XG), differences may arise.

Should this happen, load the Standard MIDI File in Sequencer mode, then manually reassign the non-matching Sounds, replacing them with similar Sounds on the Pa900. Finally, save the Standard MIDI File again, and you will be able to play it in Song Play mode with the correct Sounds.

Keyboard, Pad and Player tracks

Pa900 is equipped with a double player. Each Song can play up to a maximum of 16 Song tracks, for a total of 32 tracks. In addition, you can play the keyboard with four additional Keyboard tracks (Upper 1-3 and Lower).

When the Volume panel is shown in the main page of the Song Play mode (see illustration below), you can adjust the Volume and Play/Mute status of these tracks, but please keep in mind that these changes will not be saved in the Standard MIDI File.

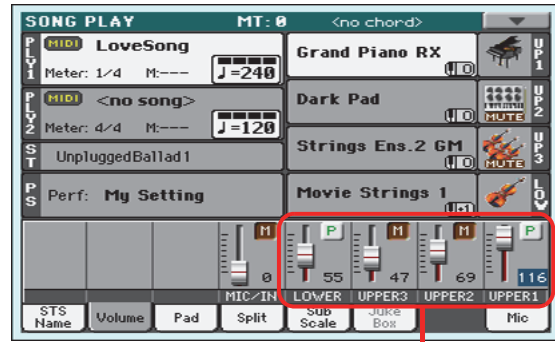

Keyboard tracks

While in Song Play mode, you can select Performances or STSs. STSs are from the latest selected Style; choose a different Style to select a different set of STSs. You can see the name of the available STSs when the STS Name panel is shown in the main page of the Song Play mode (see illustration):

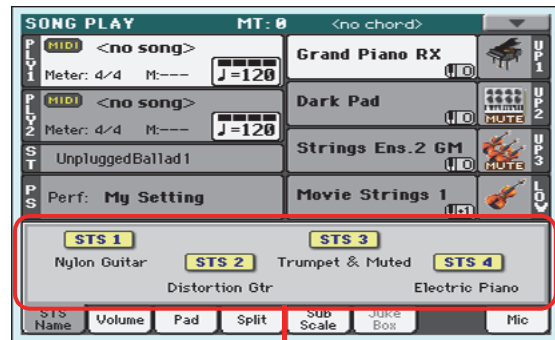

STS names

Selecting a different Style or SongBook Entry may also change the Pads.

When entering Song Play mode from the Style Play mode, Keyboard and Pad tracks remain the same they were in Style Play mode.

Main page (Normal view)

Press the SONG PLAY button to access this page from another operating mode.

Note: When switching from Style Play to Song Play mode, various track parameters and settings may change.

To return to this page from one of the Song Play edit pages, press the EXIT or SONG PLAY button.

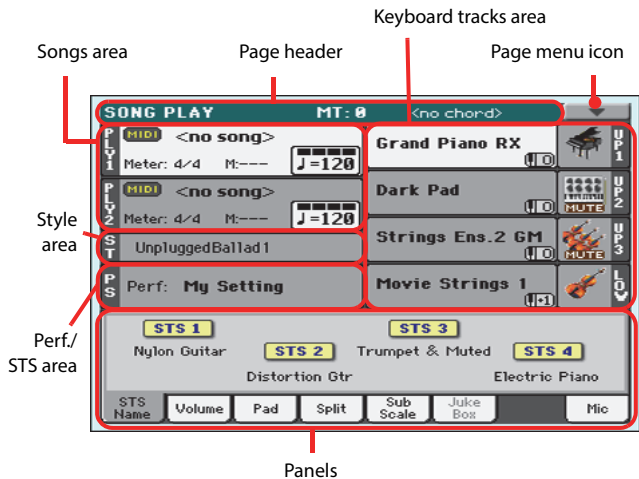

Details on individual tracks can be seen by touching the Volume tab. To switch between Keyboard tracks (Normal view) and Song tracks (Song Tracks views), use the TRACK SELECT button. Pressed a first time, you will see tracks 1-8; a second press will show tracks 9-16; pressed again will go back to Keyboard tracks.

Page header

This line shows the current operating mode, transposition and recognized chord.

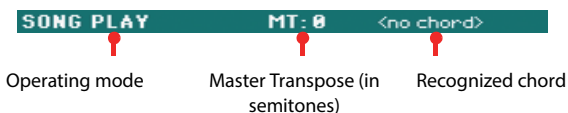

Operating mode name

Name of the current operating mode.

Master Transpose

Master Transpose value in semitones. This value can be changed using the TRANSPOSE buttons on the control panel.

Note: You can also transpose MP3 files. Keep in mind, however, that transposition always remains inside the -5...+6 semitones range. This is enough to cover all keys, while avoiding excessive audio degradation. Any further transposing will be reversed to fit the range. So, you might see a +7 transpose value (Just Fifth Up) shown in the display, but the MP3 will actually play 5 semitones lower (Just Fourth Down).

Note: Transpose may automatically change when selecting a different Performance. It may also change when loading a Standard MIDI File generated with an instrument of the Korg Pa-Series.

To avoid transposing, “lock” the Master Transpose parameter in the Global (see “General Controls: Lock” on page 249).

Recognized chord

This displays the recognized chord when you play a chord on the keyboard. If no chord abbreviation is shown, it means that no chord recognition mode has been selected by using the CHORD SCAN buttons.

Page menu icon

Touch the page menu icon to open the menu. See “Page menu” on page 176 for more information.



Songs area

This is where the Song names are shown, together with parameters depending on the selected type of Song.

This is how a Song’s area appears when a **Standard MIDI File** or **Karaoke** file has been selected:

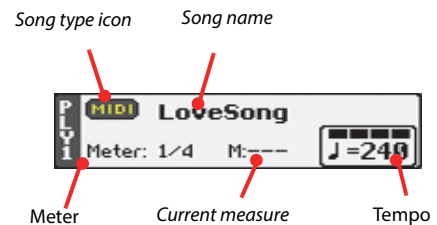

And this is how it appears when an **MP3 File** has been selected:

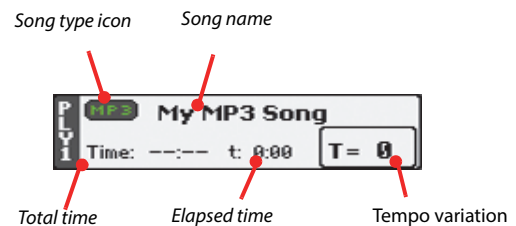

Ply 1/2

A different Song may be assigned to each of the two onboard players (Ply 1 and Ply 2). Each player has its own parameters.

Song type icon

Songs of different types can be assigned to the players. This icon shows the file type.



Standard MIDI File, often abbreviated as SMF (file extension: *.MID or *.KAR). The SMF (*.MID) is the industry standard song format, used by Pa900 as its basic Song format when recording a new Song. A MIDI Karaoke File (*.KAR) is an extension of the SMF format.



MPEG Layer-3 format, or MP3 (file extension: *.MP3). This is a compressed audio file, that may be generated on any personal computer, or by the Pa900 itself.



A Jukebox file (file extension: *.JBX) can be assigned to Player 1, but its name will not be shown in this area. The JBX icon will appear

instead, together with the name of the currently selected Song, in the Jukebox list.

Note: To create or edit a Jukebox file, go to the Jukebox Edit page (see page 175).

Song name

Displays the name of the Song assigned to the corresponding Player.

- If the Player is already selected (white background), touch the Song name to open the Song Select window.
- If the player is not selected (dark background), first select it, then touch the Song name to open the Song Select window.

When the Song Select window appears, you can select a single Song or a Jukebox file (see “Song Select window” on page 103).

If you select another Song while a Song is playing, the previous Song will stop, and the new Song will be selected and be ready to play.

To select a Song, you can also press the SELECT button (on the control panel) corresponding to the desired Player. Press it a second time to select a Song by dialing in its ID number (see “Selecting a Song by its ID number” on page 104).



Meter

This parameter only appears when a Standard MIDI File or Karaoke file has been selected.

Current Song’s meter (time signature).

Measure number

This parameter only appears when a Standard MIDI File or Karaoke file has been selected.

Current measure number.

Tempo

This parameter only appears when a Standard MIDI File or Karaoke file has been selected.

Metronome Tempo. Select this parameter and use the TEMPO+ and TEMPO- buttons to change the Tempo. As an alternative, touch this parameter and drag with your finger.

Total time

This parameter only appears when an MP3 file has been selected.

Total length (in minutes:seconds) of the selected MP3 file.

Elapsed time

This parameter only appears when an MP3 file has been selected.

Elapsed time (in minutes:seconds) of the MP3 file currently in play.

Tempo variation

This parameter only appears when an MP3 file has been selected.

Variation of the original MP3 file’s tempo, inside a range of $\pm 30\%$ of the original tempo. When Tempo is changed, MP3 files

are smoothly accelerated or slowed down (inside a range of $\pm 30\%$ of the original tempo). This may seem trivial, but it is really rocket-science instead, and it is made possible by Korg sophisticated time-stretching algorithms.

Style area

Currently selected Style. You can select a Style while playing Songs, to have it ready when switching to Style Play mode. Also, this lets you change the Pads and STSs (both are recalled by selecting a Style).

Touch the Style name to open the Style Select window. As an alternative, use the buttons in the STYLE section of the control panel.



Performance/STS area

This is where the Performance or STS name is shown.



Selected Performance or STS

This is the latest selected Performance or Single Touch Setting.

Touch the name to open the Performance Select window. As an alternative, use the PERFORMANCE section to select a different Performance.

To select a different STS from the latest selected Style, use the four STS buttons under the display.

Keyboard tracks area

This is where Keyboard tracks are shown.

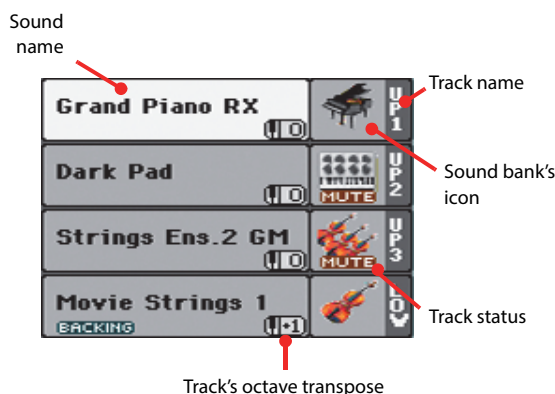

Sound name

Name of the Sound assigned to the corresponding Keyboard track.

- If the track is already selected (white background), touch the Sound name to open the Sound Select window.

- If the track is not selected (dark background), first select it, then touch the Sound name to open the Sound Select window.

You can also open the Sound Select window by using the SOUND SELECT button on the control panel.

For more information about the Sound Select window, see “Sound Select window” on page 101.

Keyboard track octave transpose

Non editable. Octave transpose of the corresponding track. To individually edit the octave transpose for each track, go to the “Mixer/Tuning: Tuning” edit page of the Song Play mode (see “Mixer/Tuning: Tuning” on page 116 for more details).

You can also transpose all Upper tracks by using the UPPER OCTAVE buttons on the control panel.

Keyboard track name

Non editable. Name of the corresponding track:

Abbreviation	Track	Hand
UP1	Upper 1	Right hand
UP2	Upper 2	
UP3	Upper 3	
LOW	Lower	Left hand

Sound bank's icon

This icon shows the bank the current Sound belongs to.

Keyboard track status

Play/mute status of the current track. Touch this icon to change the status.

No icon Play status. The track can be heard.



Mute status. The track cannot be heard.

Panels

The lower half of the main page contains the various panels, you can select by touching the corresponding tabs. See more information in the relevant sections, starting from page 169.

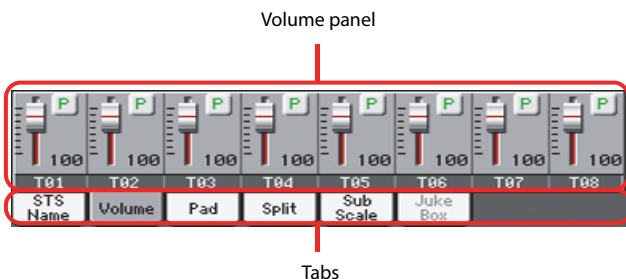

STS Name panel

Select this panel to see the name of the four available STSs. See “STS Name panel” on page 109 for details.



Volume panel

Touch the Volume tab to select this panel. This is where you can set the volume of each track, and mute/unmute tracks.

Changing the tracks' volume and play/mute status

You can change the volume and play/mute status of each track in the same way seen for the Style (see “Volume panel” on page 109 for details).

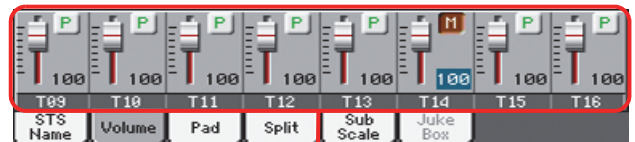

Virtual sliders

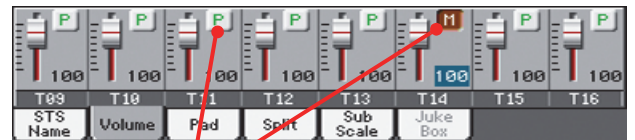

Track status icons

Saving the tracks' volume and play/mute status

Each set of tracks can be saved into a different structure. This allows for a great flexibility when mixing Keyboard and Song tracks through the use of Performances, STSs and Standard MIDI Files.

- The status of **Keyboard tracks** can be saved to a Performance or STS (see “Write Performance” on page 127 and “Write Single Touch Setting” on page 127).
- The status of the **Song tracks** can be saved as a general setting in the Global > Mode Preferences > Song & Sequencer page (see “Save Trk & FX” on page 253).

This allows for leaving the track status unchanged even when playing a different Standard MIDI File. You can leave, for example, the bass track in mute, and let your bassist play it live for the whole show.

However, an exception to the above is when reading a Standard MIDI File created with a Pa-Series instrument. These files do include special commands to force the Play/Mute status of each track.

Track names

Under the sliders, a label for each track is shown. Use the TRACK SELECT button to switch between the *Keyboard Traks* and the *Song Tracks 1-8* and *Song Tracks 9-16* views.

Abbreviation	Track
UPPER1...3	Upper tracks. Volume and play/mute status memorized into a Performance or STS.
LOWER	Lower track. Volume and play/mute status memorized into a Performance or STS.
T01...T16	Song tracks. Volume memorized into a Standard MIDI File. Play/mute status memorized as a general setting.

Pad panel

Select this panel to see which Hit or Sequence Pads are assigned to the four Pads. See “Pad panel” on page 111 for details.

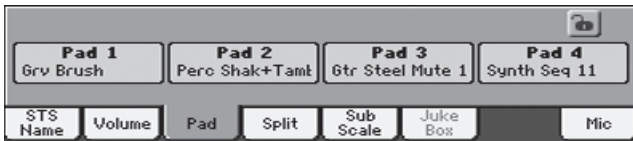

Split panel

Select this panel to adjust the split point for the Keyboard tracks. See “Split panel” on page 112 for details.

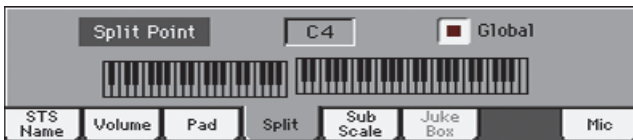

Sub-Scale panel

Select this panel to select a secondary scale for the Keyboard tracks. See “Mixer/Tuning: Sub Scale” on page 117 for details.

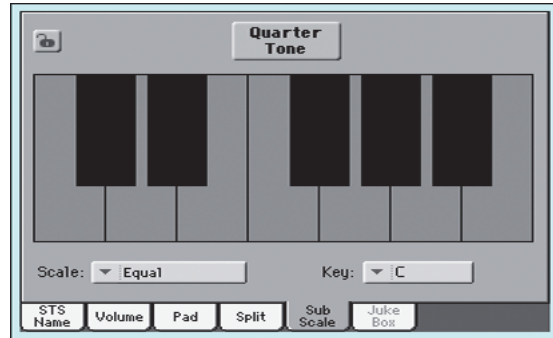

Jukebox panel

When a Jukebox (JBX) file is assigned to Player 1, you can use the list shown in this panel to browse the Jukebox list, and touch the Select button in the display to select a Song to play. This way, you can select any Song in the list as your starting Song, and manually change the order of the Songs to play.

Note: A Jukebox file can be assigned to Player 1 only.

Note: This panel is only available after loading a Jukebox file.

Hint: To create or edit a Jukebox file, go to the Jukebox Edit page (see page 175). A quick way to create a Jukebox list is to touch the “Play All” button in the Song Select window (see page 104).

Warning: If you delete a Song included in the Jukebox list currently in play, the Player will stop, and the “No Song” message will appear. At this point, you can select the JukeBox tab to open the Jukebox panel, and select a different Song.

As an alternative, you can select the next Song by pressing SHIFT + >> (FAST FORWARD) in the PLAYER section of the control panel, then press ►/■ (PLAY/STOP) in the PLAYER section again.

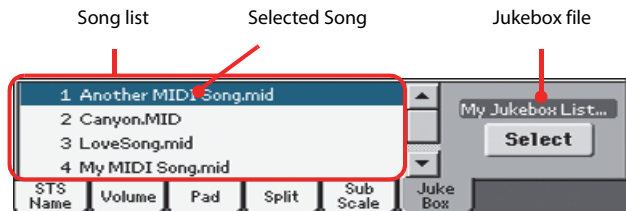

Song list

Use this list to browse through the Songs in the Jukebox list. Use the scrollbar to scroll the list.

Selected Song

Name of the Song currently in play. You can select a different Song from the list, and touch the Select button in the display to select it for playback.

Select button

Touch this button to select the Song highlighted in the list, and assign it to the player. If a Song is already playing, it will be stopped, and the selected Song will start playing back.

Jukebox file

Name of the selected Jukebox file. To edit this file, see “Jukebox Editor” on page 175.

Transport controls for the Jukebox

When you select a Jukebox file, Player 1 transport controls behave in a slightly different way than with single Songs.

<< and >> Pressed alone, these buttons are the Rewind and Fast Forward commands.

(SHIFT) Keep the SHIFT button pressed, and press these buttons to scroll to the previous or next Song in the Jukebox list.

◀ (HOME) Returns to measure 1 of the current Song.

▶/■ (PLAY/STOP)

Starts or stops the current Song. When you stop the Song, it is stopped at the current position. Press HOME to go back to measure 1 of the current Song.

If the Jukebox panel is open, you can select the Song from which to start. See “Jukebox panel” above.

Mic panel

Touch the Mic tab to select this panel. Parameters are the same seen for the Style Play mode (see “Mic panel” on page 113).

Edit menu

From any page, press the MENU button to open the Song Play edit menu. This menu gives access to the various Song Play edit sections.

When in the menu, select an edit section, or press EXIT or SONG PLAY to exit the menu.

When in an edit page, press the EXIT or SONG PLAY button to go back to the main page of the Song Play operating mode.

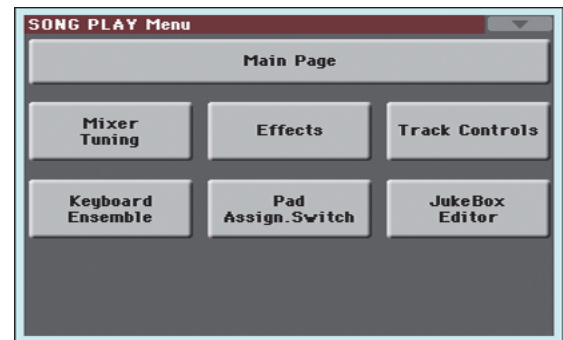

Each item in this menu corresponds to an edit section. Each edit section groups various edit pages, that may be selected by touching the corresponding tab on the lower part of the display.

Note: Some of the edit parameters are only meant for realtime use. As a general rule, Keyboard track parameters can be saved to a Performance or SongBook STS, while Song track's Play/Mute status and FX settings can be saved as a general setting in the Global > Mode Preferences > Song & Sequencer page (see “Save Trk & FX” on page 253).

Edit page structure

All edit pages share some basic elements, already described for the Style Play mode (see “Edit page structure” on page 113 for details).

Mixer/Tuning: Volume/Pan

This page lets you set the volume and pan for each of the Keyboard or Song tracks.

Note: The play/mute status of a Song track may be reset when selecting a Song created on a Pa-Series instrument.

Use the TRACK SELECT button to switch from the Keyboard to the Song tracks, and vice versa.

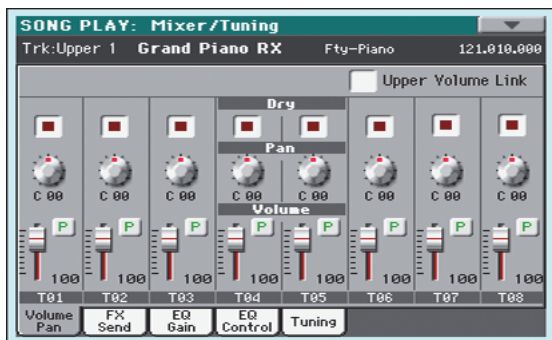

Parameters

The parameters shown in this page are the same already seen for the Style Play mode. See “Mixer/Tuning: Volume/Pan” on page 114 for details.

Mixer/Tuning: FX Send

Pa900 is equipped with two groups of effect processors (A and B). In Song Play mode, these groups can be used to process Keyboard, Pad and MIDI tracks.

- Keyboard tracks always use the effects of the FX B group.
- Pad tracks always use the effects of the FX A group.
- Standard MIDI Files and Karaoke files can only use the effects of the FX A group.
- Standard MIDI Files created on a Pa-Series instrument (in Sequencer mode) can use effects of the FX A and B groups.

Choosing and editing the effects is done in the dedicated Effect section (see “Effects: A/B FX Configuration” on page 173).

In case you do not want to hear the direct signal, just set the Dry parameter to Off (see the “Dry” parameter above).

You can assign to the Master FXs any kind of available effects, but we suggest you assign the effects based on this scheme:

- A-Master 1 Reverb processor for the Song tracks.
- A-Master 2 Modulating FX processor for the Song tracks.
- B-Master 1 Reverb processor for the Keyboard tracks.
- B-Master 2 Modulating FX processor for the Realtime (Keyboard) tracks.

Use the TRACK SELECT button to switch from Keyboard to Song tracks, and vice-versa.



Note: When you stop, then start the Song again, or select a different Song, the default Song track settings are selected again. You can, however, pause the Song, change the effects, then exit from pause and start the Song again. Edit the Song in Sequencer mode to permanently change the effects.

Note: Track FX setting can be saved as a general setting in the Global > Mode Preferences > Song & Sequencer page (see “Save Trk & FX” on page 253). This will help adapting the Pa900’s sound to personal taste for any Standard MIDI File (excluding those saved by a Pa-Series instrument, that may override the general preferences).

Parameters

The parameters shown in this page are the same already seen for the Style Play mode. See “Mixer/Tuning: FX Send” on page 115 for details.

Mixer/Tuning: EQ Gain

In this page you can set the three-band equalization (EQ) for each individual track.

Use the TRACK SELECT button to switch from the Keyboard to the Song tracks, and vice-versa.

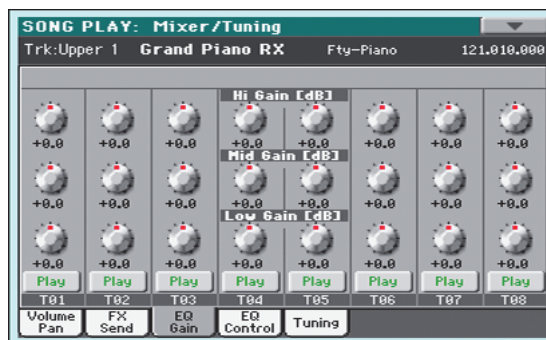

Hint: Track EQ can be saved as a general setting in the Global > Mode Preferences > Song & Sequencer page (see “Save Trk & FX” on page 253). This will help adapting the Pa900’s sound to personal taste for any Standard MIDI File you will ever play (excluding those saved by a Pa-Series instrument, that may override the general preferences). Need a lighter Bass track? Save the right equalization, and the Bass will stay light with all the subsequent Songs.

Parameters

The parameters shown in this page are the same already seen for the Style Play mode. See “Mixer/Tuning: EQ Gain” on page 115 for details.

Mixer/Tuning: EQ Control

This page lets you reset or bypass track equalization, programmed in the previous page.

Use the TRACK SELECT button to switch from the Keyboard to the Song tracks, and vice-versa.

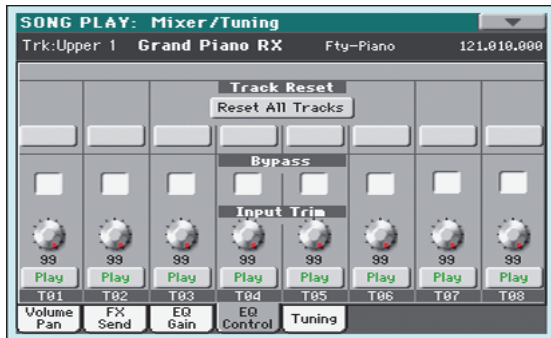

Parameters

The parameters shown in this page are the same already seen for the Style Play mode. See “Mixer/Tuning: EQ Control” on page 116 for details.

Mixer/Tuning: Tuning

Parameters in this page let you set various tuning settings. All parameters in this page are the same found in Global mode. See “Mixer/Tuning: Tuning” on page 116 for details.

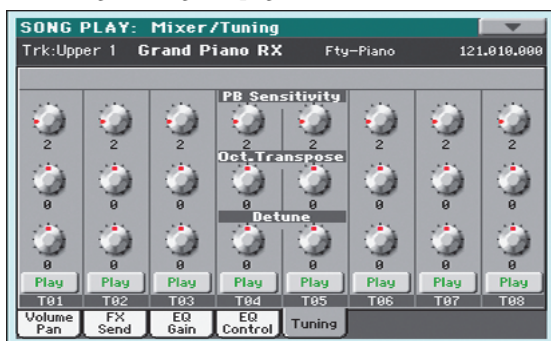

Parameters

The parameters shown in this page are the same already seen for the Style Play mode. See “Mixer/Tuning: Tuning” on page 116 for details.

Note: Song track values edited in this page are not saved, and are only intended for realtime use.

Effects: A/B FX Configuration

This page allows you to select the effects for the A (Song) and B (Keyboard) FX groups. You can use the “FX A” and “FX B” side tabs to switch from one group to the other one. (Songs created in Sequencer mode on a Pa-Series instrument can also use the B FX group).

The effect types and the FX matrix are the same seen for the Style Play mode (see “Effects: A/B FX Configuration” on page 119),

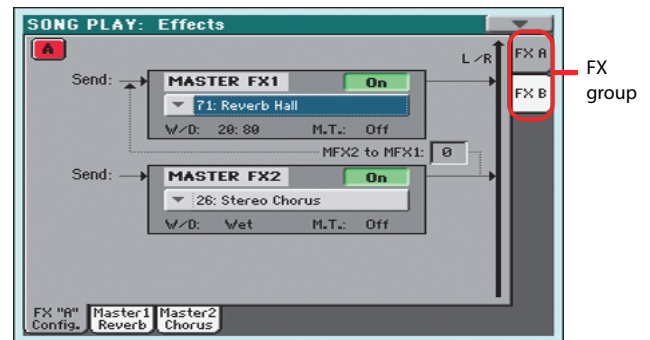

Note: The default effect settings can be saved as a general setting in the Global > Mode Preferences > Song & Sequencer page (see “Save Trk & FX” on page 253).

Note: When you stop the Song, or select a different Song, the default effects are selected again. You can, however, stop the Song, change the effects, then start the Song again with the new effects. Edit the Song in Sequencer mode to permanently change the effects.

Parameters

The parameters shown in this page are the same already seen for the Style Play mode. See “Effects: A/B FX Configuration” on page 119 for details.

M.T. (Modulating Track)

Source track for modulating MIDI messages. You can modulate an effect parameter with a MIDI message generated by an internal physical controller, or a MIDI message coming from a Song track.

Effects: Master 1, 2

These pages contain the editing parameters for the effect processors. Here is an example of the FX A page, with the Reverb Hall effect assigned.

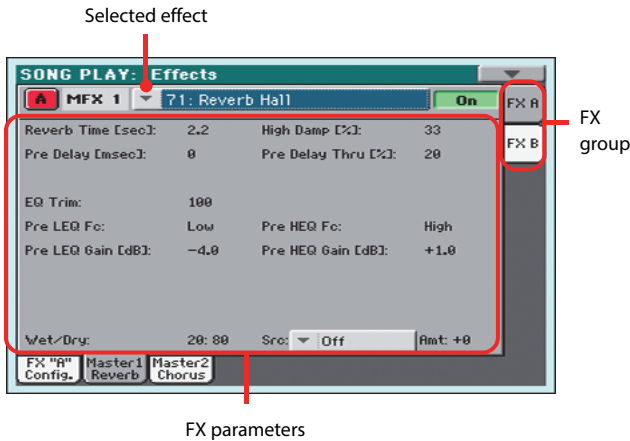

Parameters

The parameters shown in this page are the same already seen for the Style Play mode. See “Effects: Master 1, 2” on page 119 for details.

Track Controls: Mode

These parameters let you set the Internal/External, and the Poly/Mono status of Song tracks.

Parameters

The parameters shown in this page are the same already seen for the Style Play mode. See “Track Controls: Mode” on page 120 for details.

Note: These parameters can be saved as a general setting in the Global > Mode Preferences > Song & Sequencer page (see “Save Trk & FX” on page 253).

Track Controls: Drum Edit

These parameters let you adjust the volume and edit the main parameters for each percussive instrument family.

Drum Edit parameters

The parameters shown in this page are the same already seen for the Style Play mode. See “Track Controls: Drum Edit” on page 121 for details.

Note: Song track values edited in this page are not saved, and are only intended for realtime use.

Track Controls: Easy Edit

These parameters let you “fine-tune” edit parameters for Sounds assigned to the tracks.

Easy Sound Edit parameters

The parameters shown in this page are the same already seen for the Style Play mode. See “Track Controls: Easy Edit” on page 122 for details.

Note: Song track values edited in this page are not saved, and are only intended for realtime use.

Keyboard/Ensemble: Key/Velocity Range

These parameters let you select a note and velocity range for the Keyboard tracks.

Parameters

The parameters shown in this page are the same already seen for the Style Play mode. See “Keyboard/Ensemble: Key/Velocity Range” on page 123 for details.

Keyboard/Ensemble: Ensemble

This page lets you program the Ensemble function.

Parameters

The parameters shown in this page are the same already seen for the Style Play mode. See “Keyboard/Ensemble: Ensemble” on page 123 for details.

Keyboard/Ensemble: Keyboard Control

These parameters let you set parameters for the Keyboard tracks.

Parameters

The parameters shown in this page are the same already seen for the Style Play mode. See “Keyboard/Ensemble: Keyboard Control” on page 124 for details.

Pad/Switch: Pad

This page lets you select a different hit sound or sequence for each of the four PAD buttons.

Parameters

The parameters shown in this page are the same already seen for the Style Play mode. See “Pad/Switch: Pad” on page 125 for details.

Pad/Switch: Assignable Switch

This page lets you select a different function for each of the ASSIGNABLE SWITCH buttons.

Parameters

The parameters shown in this page are the same already seen for the Style Play mode. See “Pad/Switch: Switch” on page 125 for details.

Jukebox Editor

The Jukebox function lets you play a list of Songs (127 max), at the touch of a button. You can play a Jukebox file by assigning it to Player 1, after having selected it in the Song Select page, just as if it was an ordinary Song (see “Jukebox panel” on page 170).

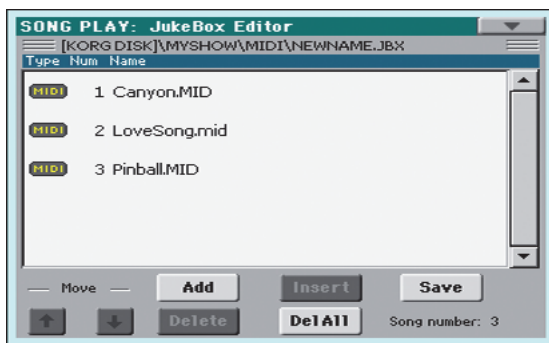

In this page you can create, edit and save a Jukebox file. A Jukebox list can contain Standard MIDI Files, Karaoke™ files, and MP3 files.

If a Jukebox file is already selected, you will enter this page with that file ready to be edited. Otherwise, you will enter this page with an empty list.

To create a new Jukebox file, touch Del All to remove all Songs from the current list. Add new Songs, then touch Save and enter a different name before confirming. A new Jukebox file will be saved to the storage device.

Move Up/Down

Use these buttons to move the selected item up or down in the list.

Add

Adds a Song at the end of the current list. You can add up to 127 Songs to a list. When this button is pressed, a standard file selector opens up in the display.

Note: A Jukebox list can include only Songs contained in the same folder.

Hint: Instead of a single Song, you can select a Jukebox file, and add its whole content to the current Jukebox list.

Insert

Inserts a Song at the current position (i.e., between the selected item and the preceding one). All subsequent Songs are moved to the next higher-numbered slot. You can add up to 127 Songs to a list.

Note: A Jukebox list can include only Songs contained in the same folder.

Hint: Instead of a single Song, you can select a Jukebox file, and insert its whole content to the current Jukebox list.

Delete

This command lets you delete the selected Song from the list.

Del All

Select this command to delete the whole Jukebox list.

Save

Touch this button to save the Jukebox file. The Save Jukebox File dialog box appears, allowing you to edit the name and save your file.

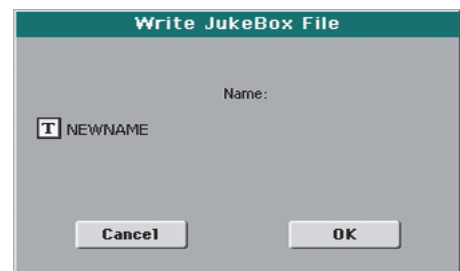

Touch the **T** (Text Edit) button to open the Text Edit window, and edit the name.

If you are editing an existing list, and do not change its name, the old file is overwritten. If you change it, a new file will be created in the storage device.

If you are saving a new list, the “NEWNAME.JBX” name is automatically assigned, and you can edit it.

Note: You can save your “.JBX” file only in the same folder as the Song files included in the list.

Page menu

Touch the page menu icon to open the menu. Touch a command to select it. Touch anywhere in the display to close the menu without selecting a command.

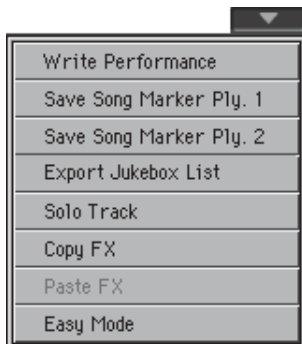

Write Performance

Select this command to open the Write Performance dialog box, and save most of the current control panel settings to a Performance.

See “Write Performance dialog box” on page 128 for more information.

Save Song Marker Ply.1/2

Select this command to save the markers created in the corresponding Player (see “Markers page” on page 307).

Export Jukebox List

Only available when a Jukebox list is selected. Select this command to save the current Jukebox list as a text file to a storage device. Here is how it works.

1. While a Jukebox file is assigned to the player, select the Export Jukebox List command from the page menu.
2. A dialog box will appear, asking you to select either the internal disk or a storage device connected to one of the USB Host ports.

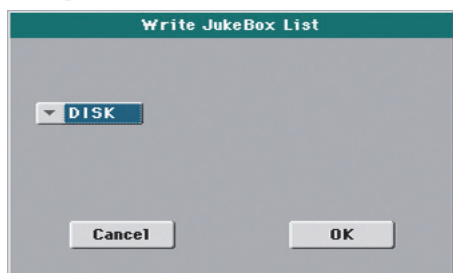

3. Select an option, and touch OK to confirm.

Note: When saved, the text file will be named after the selected Jukebox file. For example, a Jukebox file named “Dummy.jbx” will generate a “Dummy.txt” file. A new, unnamed Jukebox file will generate a “New_name.txt” file. If a file with the same name already exists on the target device, it will be overwritten without waiting for any confirmation.

The list will include the progressive number assigned to each Song, the file names, the total number of files in the list.

For the correct display and printing of the list on a personal computer, use a fixed size (i.e., non-proportional) character in your text editor.

Solo Track

Select the track of the current Player to be soloed, and check this item. You will hear only the selected track, and the ‘Solo’ warning will flash on the page header.

Uncheck this item to exit the Solo function.

The Solo functions works in a slightly different way, depending on the selected track:

- **Keyboard track:** The selected Keyboard track is the only track you can hear when playing on the keyboard. All other Keyboard tracks are muted. Song tracks are left in play status.
- **Song track:** The selected track is the only Song track you can hear. All other Song tracks are muted. Keyboard tracks are left in play status.

[SHIFT] Keep the SHIFT button pressed and touch one of the tracks to solo it. Do the same on a soloed track to deactivate the Solo function.

Copy/Paste FX

Use this command to copy a single effect, or both effects of an FX group (A or B). See “Copy/Paste FX” on page 127 for detailed instructions.

Easy Mode

Easy Mode allows you to use the Style Play and Song Play modes with an easier-to-use user interface. It is recommended to beginners, and to professionals alike that do not want to deal with the extra parameters of the Advanced mode.

At any time, you can manually turn the Easy Mode on/off with the Easy Mode command in the page menu of the Style Play and Song Play modes.

Sequencer mode

The Sequencer operating mode is the full-featured onboard sequencer, where you can create a Song from scratch, or edit it. You can also use this mode to edit the initial parameters of a Standard MIDI File, either made with an external sequencer or with Pa900's own sequencer.

You can save the new or edited Song as a Standard MIDI File (SMF, i.e., a file with the ".MID" extension), and play it back either in Song Play or Sequencer mode – or on any external sequencer.

Transport controls

To play back a Song, use the PLAYER 1 transport controls (i.e., the one on the left side of the PLAYER area). While in Sequencer mode, Player 2 controls are deactivated.

Standard MIDI Files and MP3

The Songs and the Standard MIDI File format

The native Song format for Pa900 is the Standard MIDI File (.MID file).

When saving a Song as a SMF, a setup measure is automatically inserted at the beginning of the Song. This measure contains various Song initialization parameters.

When an SMF is loaded, the setup measure is automatically removed.

Sequencer mode and the MP3

While in Sequencer mode, you cannot load nor record MP3 files. This mode only allows for editing of the Standard MIDI Files.

Songs and Voice Processor Presets

You can use the Voice Processor while in Sequencer mode. For this, just two settings are needed:

- Select the Song track where you are recording chords for the Voice Processor (see "Song Control" on page 266).
- Select the desired Voice Processor Preset.

Sequencer Play - Main page

Press the SEQUENCER button to access this page from another operating mode. In this page you can load a Song, and play it back using the PLAYER 1 transport controls.

Note: When switching from Style Play to Sequencer mode, the Sequencer Setup is automatically selected, and various track parameters may change.

To return to this page from any of the Sequencer edit pages, press the EXIT or SEQUENCER button.

To switch between Song tracks 1-8 and 9-16, use the TRACK SELECT button.

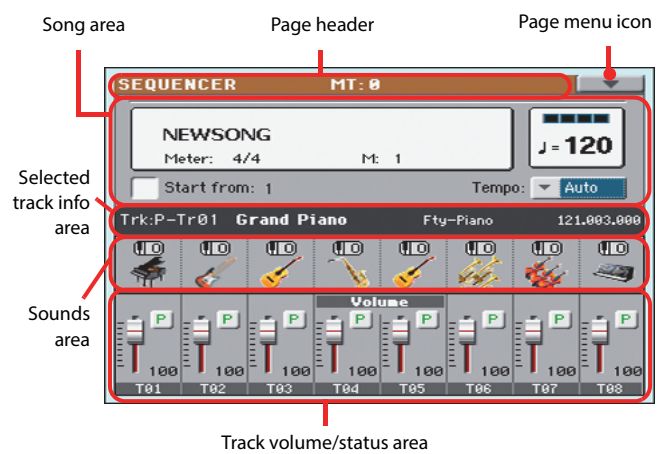

Page header

This line shows the current operating mode and transposition.



Operating mode name

Name of the current operating mode.

Master Transpose

Master transpose value in semitones. This value can be changed using the TRANSPOSE buttons on the control panel.

Note: Transpose may be automatically changed when loading a Standard MIDI File generated with an instrument of the Korg Pa-Series.

Page menu icon

Touch the page menu icon to open the menu. See "Page menu" on page 198 for more information.



Song area

This is where the Song name is shown, together with its tempo and meter (time signature) parameters, and the current measure.

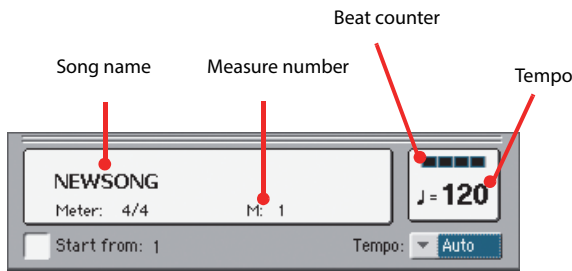

Song name

Displays the name of the selected Song. “NEWSONG” means that a new (blank) Song is selected, and you can record it.

Touch the Song name to make the Song Select window appear, allowing for selection of a different Song (see “Song Select window” on page 103).

To select a Song, you can also press the SELECT button in the PLAYER 1 section of the control panel. Press SELECT a second time to select a Song by dialing in its ID number (see “Selecting a Song by its ID number” on page 104).

Note: Only Standard MIDI Files can be loaded. MP3 files cannot be loaded in Sequencer mode.

Meter

Current meter (time signature).

Measure number

Current measure number.

Tempo

Metronome Tempo. Select this parameter and use the TEMPO buttons to change Tempo. As an alternative, when a different parameter is selected, or you are in a different page, keep the SHIFT button pressed and use the DIAL to change Tempo for the sequencer.

Start from

When checked, the measure shown by this parameter is a temporary start point of the song, instead of measure 1. When you press the ◀ (HOME) button, or use the << (REWIND) button to go back to the beginning, the Song returns to this point.

Tempo (Tempo mode)

Use this menu to select the Tempo change mode.

Manual In this mode, you can change Tempo by using the TEMPO buttons. The Song will be played back using the manually selected tempo.

Auto Tempo recorded in the Song will be used.

Selected track info area

This line lets you see the Sound assigned to the selected track. Not only it is shown on the main page, but also in several edit pages.

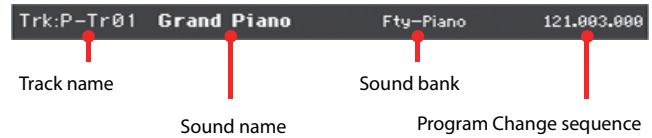

Track name

Name of the selected track.

Sound name

Sound assigned to the selected track. Touch anywhere in this area to open the Sound Select window, and select a different Sound.

Sound bank

Bank the selected Sound belongs to.

Program Change

Program Change number sequence (Bank Select MSB, Bank Select LSB, Program Change).

Sounds area

This area lets you see Sounds and octave transposition for the eight tracks currently displayed.

Song track octave transpose icon



Sound bank's icon

Song track octave transpose

Non editable. Octave transpose of the corresponding track. To edit the octave transpose, go to the “Mixer/Tuning: Tuning” edit page (see page 116 for programming information).

Sound bank's icon

This picture illustrates the bank the current Sound belongs to. Touch an icon a first time to select the corresponding track (detailed information are shown on the Selected Track Info area, see above). Touch it a second time to open the Sound Select window.

Track volume/status area

This area is where you can set the volume of each Song track, and mute/unmute tracks.

Volume and virtual sliders

Drag the sliders to adjust the volume of the corresponding tracks. You can also change the volume by touching a slider and using the VALUE DIAL.

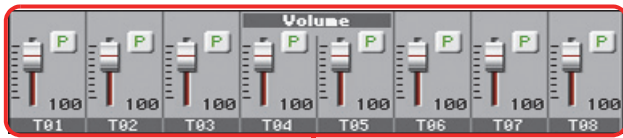

Virtual sliders

Use the TRACK SELECT button to switch between *Song Tracks 1-8* and *Song Tracks 9-16*.

Track status icon

Play/mute status of the current track. Select the track, then touch this area to change the track status. The status of Song tracks is saved when saving the Song.



Play status. The track can be heard.



Mute status. The track cannot be heard.

Track names

Under the sliders, a label for each track is shown. Use the TRACK SELECT button to switch between tracks 1-8 and 9-16.

Abbreviation	Track
T01...T16	Song tracks. Volume memorized into a Standard MIDI File. Play/mute status memorized into the Standard MIDI File as well, and can be read in Song Play mode.

Entering Record mode

To enter Record mode, press the RECORD button while you are in Sequencer mode. The following dialog box will appear:



Select one of the three available recording options and touch OK (or Cancel if you don't want to enter Record mode).

Multitrack Sequencer

Full-featured sequencer. Select this option for classic multitrack recording. (See "Record mode: Multitrack Sequencer page" on page 180).

Backing Sequence (Quick Record)

Easy way of recording. Just play with Styles, and record your realtime performance.

Step Backing Sequence

Step-record. Edit chords and controls for the Style. Very useful if you are not a keyboard player.

Record mode: Multitrack Sequencer page

While in Sequencer mode, press the RECORD button and select the “Multitrack Sequencer” option. The Multitrack Sequencer page appears.

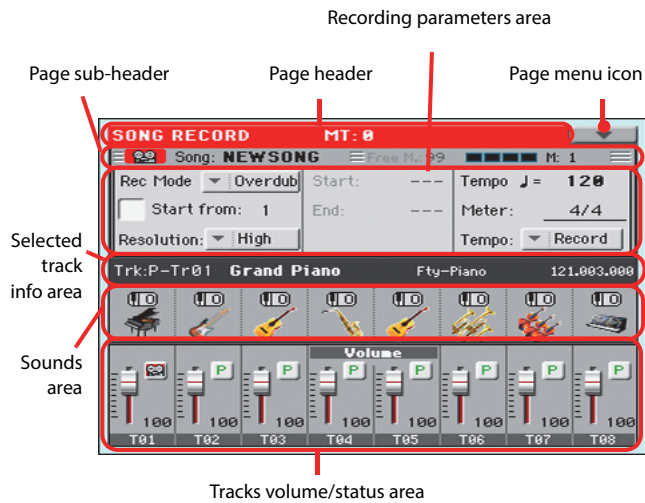

See “Multitrack recording procedure” on page 181 for information on the record procedure.

Page header

See “Page header” on page 177.

Page menu icon

See “Page menu icon” on page 177.

Page sub-header

This area shows some performing info on the Song.



Song name

Name of the Song in record.

Free memory %

Percentage of remaining memory available for recording.

Beat counter

This indicator shows the current beat inside the current measure.

Measure number

Current measure you are recording.

Recording parameters area

Rec mode (Recording mode)

Set this parameter before starting record, to select a recording mode.

- Overdub** The newly recorded events will be mixed to any existing events.
- Overwrite** The newly recorded events will replace any existing events.
- Auto Punch** Recording will automatically begin at the “Start” position, and stop at the “End” position.

Note: The Auto Punch function will not work on an empty Song. At least one track must already be recorded.

- PedalPunch** Recording will begin when pressing a pedal set to the “Punch In/Out” function, and will finish when pressing the same pedal again.

Note: The Pedal Punch function will not work on an empty Song. At least one track must already be recorded.

Start from

When checked, the measure shown by this parameter is a temporary start point of the song, instead of measure 1. When you press the ►/■ (PLAY/STOP) button to stop recording, or use the << (REWIND) button to go back to the beginning, the Song returns to this point.

Resolution

Use this parameter to set the quantization during recording. Quantization is a way of correcting timing errors; notes played too soon or too late are moved to the nearest axis of a rhythmic “grid”, set with this parameter, thus playing perfectly in time.

High No quantization applied.

♩ (1/32)... ♩ (1/8)

Grid resolution, in musical values. For example, when you select 1/16, all notes are moved to the nearest 1/16 division. When you select 1/8, all notes are moved to the nearest 1/8 division.



Start/End

Start and End locators. These parameters area available only when the “Auto Punch” recording mode is selected. They set the starting and ending points of the Punch recording.

Tempo

Select this parameter, and use the TEMPO controls to set the Tempo value.

Meter

This is the basic meter (or time signature) of the Song. You can edit this parameter only when the Song is empty, i.e., before you begin recording anything. To insert a meter change in the middle of the Song, use the “Insert Measure” function (see page 196).

Tempo (Tempo mode)

This parameter sets the way tempo events are read or recorded.

Manual	Manual reading. The latest manual Tempo setting (made using the TEMPO buttons) is considered the current Tempo value. No Tempo change events will be recorded. This is very useful when you want to record the Song at a much slower speed than the actual Tempo.
Auto	Auto reading. The Sequencer plays back all recorded Tempo events. No Tempo change events are recorded.
Record	All Tempo changes made during recording will be recorded to the Master Track.

Note: Tempo is always recorded in overwrite mode (old data is replaced by the new data).

Selected track info area

This line lets you see the Sound assigned to the selected track. See “Selected track info area” on page 178 for more information.

Sounds area

This area lets you see Sounds and octave transposition for the eight tracks currently displayed. See “Sounds area” on page 178 for more information.

Track volume/status area

This area is where you can set the volume of each Song track, and change track status. See “Track volume/status area” on page 179.

Track status icons

Play/mute/record status of the current track. Select the track, then touch this area to change its status.



Play status. The track can be heard.



Mute status. The track cannot be heard.



Record status. After pressing ►/■ (PLAY/STOP) to start recording, the track will receive notes from the keyboard and the MIDI IN or USB Device connector.

Multitrack recording procedure

Here is the general procedure to follow for the Multitrack Recording.

1. Press the SEQUENCER button to enter Sequence mode.
2. Press the RECORD button, and select the “Multitrack Sequencer” option to enter the Multitrack Record mode. Now you can prepare your recording parameters. (For more details, see “Record mode: Multitrack Sequencer page” on page 180).
3. Be sure the Overdub or Overwrite recording options is selected (see “Rec mode (Recording mode)” on page 180).
4. Set the Tempo. There are two ways of changing Tempo:
 - Use the TEMPO buttons to change the tempo
 - Touch the “Tempo” parameter, and use the VALUE DIAL to change Tempo.
5. Use the TRACK SELECT button to switch between Song Tracks 1-8 and Song Tracks 9-16, and assign the desired Sound to each track (see “Sound bank’s icon” on page 178).
6. Select the track to be recorded. Its status icon will automatically change to Record (see “Track status icons” on page 181).
7. If this is a second-pass recording, use the “Start from” parameter to enter a measure where you want to start recording.
8. Press the METRO button to turn the metronome on, and start practicing.
9. Press ►/■ (PLAY/STOP) to start recording. After a 1-bar precount, the recording actually begins. After the precount, play freely.
 - If you selected the Auto Punch recording mode, the recording will begin only when reaching the Start point.
 - If you selected the Pedal Punch recording mode, press the pedal when you want to begin recording. Press it again to finish recording.

Note: The Punch functions will not work on an empty Song. At least one track must already be recorded.
10. When finished recording, press ►/■ (PLAY/STOP) to stop the sequencer. Select a different track, and go on recording the whole Song.
11. When finished recording the new Song, either press the RECORD button, or select the “Exit from Record” command from the page menu (see page 199).

Warning: Save the Song to a storage device, to avoid losing it when the instrument enters standby.

Note: When exiting the Record mode, the Octave Transpose is automatically reset to “0”.
12. If you wish, edit the new Song, by pressing the MENU button, and selecting the various edit pages.

Record mode: Step Record page

The Step Record allows you to create a new Song by entering single notes or chords to each track. This is very useful when transcribing an existing score, or needing a higher grade of detail, and is particularly suitable to create drum and percussion tracks.

To access this page, select the “Overdub Step Recording” or “Overwrite Step Recording” command from the page menu.

In Overdub Step Recording mode you will add to existing events, while in Overwrite Step Recording mode you will overwrite all existing events.

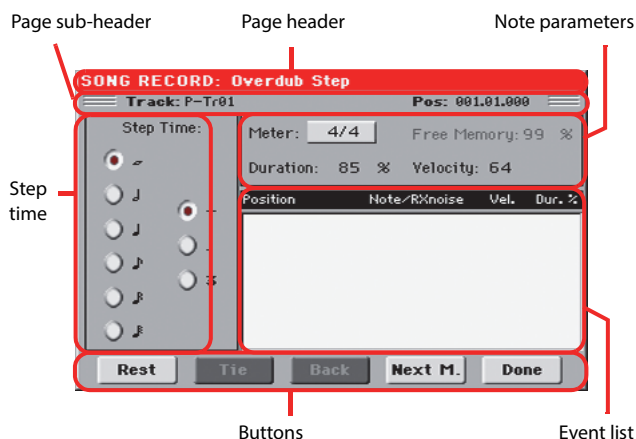

See “Step Record procedure” below, for information on the record procedure.

Page header

This line shows the current operating mode.

Page sub-header

Track

Name of the selected track in record.

Tr01...Tr16 Song track.

Pos (Position)

This is the position of the event (note, rest or chord) to be inserted.

Step Time area

Step Time

Length of the event to be inserted.

- ... Note value.
- Standard (-) Standard value of the selected note.
- Dot (.) Augments the selected note length by one half of its value.
- Triplet (3) Triplet value of the selected note.

Note parameter area

Meter

Meter (Time Signature) of the current measure. This parameter cannot be edited. You can set a Meter change by using the Insert function of the Edit menu, and inserting a new series of measures with a different Meter (see “Song Edit: Cut/Insert Measures” on page 196).

Free Memory

Available memory for recording.

Duration

Relative duration of the inserted note. The percentage is always referred to the step value.

- 50% Staccato.
- 85% Ordinary articulation.
- 100% Legato.

Velocity

Set this parameter before entering a note or chord. This will be the playing strength (i.e., velocity value) of the event to be inserted.

- Kbd Keyboard. You can select this parameter, by turning the VALUE DIAL all counter-clockwise. When this option is selected, the playing strength of the played note is recognized and recorded.
- 1...127 Velocity value. The event will be inserted with this velocity value, and the actual playing strength of the note played on the keyboard will be ignored.

Event list area

List of inserted events

Previously inserted events. You may delete the last of these events, and make it ready for a new event, by touching the Back button in the display.

- Position Position where the event has been inserted. The value is shown in the “measure.beat.tick” format.
- Note/RX Noise Name of the inserted Note or RX Noise. When entering a chord, a series of dots is shown after the name of the root note.
- Vel. Velocity of the inserted event.
- Dur.% Percentage duration of the inserted event.

Buttons

Rest

Touch this button to insert a rest.

Tie

Touch this button to tie the note to be inserted to the previous one. A note with the same pitch, and the specified length, will be created, and tied to the previous one.

Back

Goes to the previous step, erasing the inserted event.

Next M. (Next Measure)

Goes to the next measure, and fills the remaining space with rests.

Done

Exits the Step Record mode.

Step Record procedure

Here is the general procedure to follow for the Step Recording.

1. Press the SEQUENCER button to enter Sequencer mode.
2. Press the RECORD button, and select the “Multitrack Sequencer” option to enter the Multitrack Record mode. From the page menu, select the “Overdub Step Recording” or “Overwrite Step Recording” mode. At this point, the Step Record window will appear in the display.
3. The next event will be entered at the position shown by the Pos indicator in the upper right corner of the display.
 - If you don’t want to insert a note at this position, insert a rest instead, as shown in step 5.
 - To jump to the next measure, filling the remaining beats with rests, touch the Next M. button in the display.
4. To change the step value, use the Step Time parameters.
5. Insert a note, rest or chord at the current position.
 - To insert a single note, just play it on the keyboard. The inserted note length will match the step length. You may change the velocity and relative duration of the note, by editing the Velocity and Duration parameters. See “Velocity” and “Duration” on page 182.
 - To insert a rest, just touch the Rest button in the display. Its length will match the step value.
 - To tie the note to be inserted to the previous one, touch the Tie button in the display. A note will be inserted, tied to the previous one, with exactly the same pitch. You don’t need to play it on the keyboard again.
 - To insert a chord or a second voice, see “Chords and second voices in Step Record mode” on page 183.
6. After inserting a new event, you may go back by touching the Back button in the display. This will delete the previously inserted event, and set the step in edit again.
7. When finished recording, touch the Done button in the display. A dialog box appears, asking you to either cancel, discard or save the changes.



If you touch Cancel, exit is canceled, and you can continue editing. If you choose No, changes are not saved, and the Step Record window is closed. If you choose Yes, changes are saved, and the Step Record window is closed.

8. From the main page of the Multitrack Recording mode, either select the “Exit from Record” command from the page menu, or press the RECORD button to exit the Record mode.
9. While in the main page of the Sequencer mode, you may press the ►/■ (PLAY/STOP) button in the PLAYER 1 section to listen to the Song, or select the Save Song command from the page menu to save the Song to a storage device (see “Save Song window” on page 199).

Chords and second voices in Step Record mode

You are not obliged to insert single notes in a track. There are several ways to insert chords and double voices. Lets look at some.

Entering a chord. Simply play a chord instead of a single note. The event name will be the first note of the chord you pressed, followed by the “...” abbreviation.

Entering a chord made of notes with different velocity values. You can make the upper or lower note of a chord, for example, louder than the remaining ones, to let the most important stand out from the chord. Here is how to insert a three-note chord:

1. Edit the first note’s Velocity value.
2. Press the first note and keep it pressed.
3. Edit the second note’s Velocity value.
4. Press the second note and keep it pressed.
5. Edit the third note’s Velocity value.
6. Press the third note, then release all notes.

Entering a second voice. You can insert passages where one note is kept pressed, while another voice moves freely.

Ex. 1:

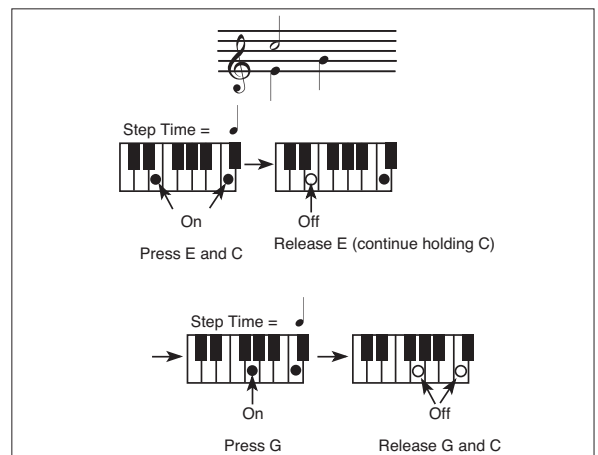

Ex.2:

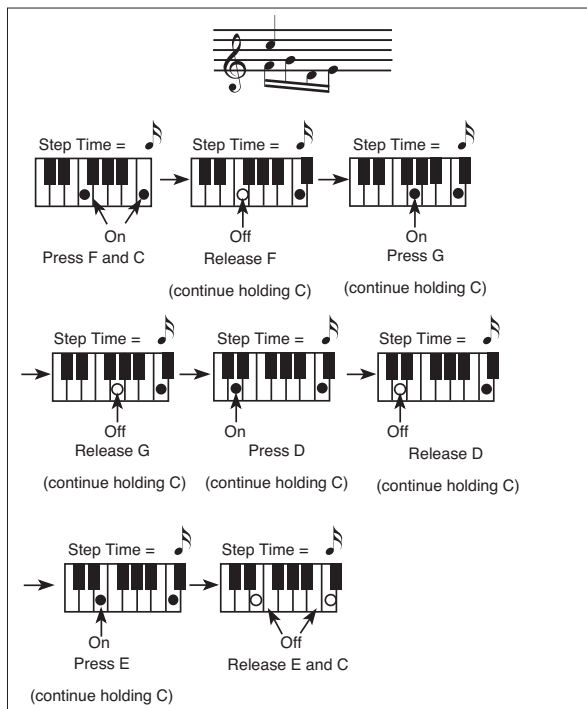

Ex.3:

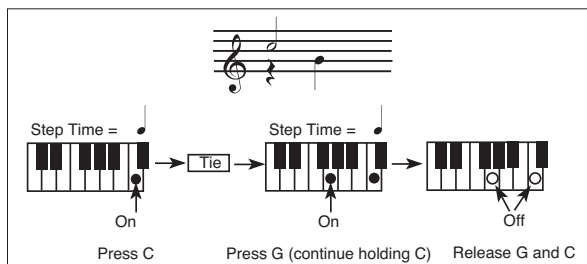

Record mode: Backing Sequence (Quick Record) page

Backing Sequence (Quick Record) mode allows you to quickly record your live performance with the backing of the Styles. To make things easier, just two grouped tracks are provided: **Kbd/Pad** (Keyboard and Pads) to record keyboard and pads, and **Ch/Acc** (Chords/Accompaniment) to record chords and the accompaniment provided by the Style.

While in Sequencer mode, press the RECORD button and select the “Backing Sequence (Quick Record)” option. The Backing Sequence (Quick Record) page appears.

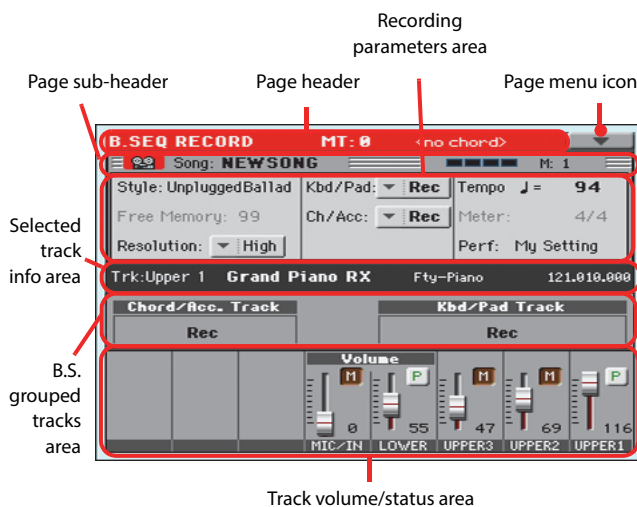

See “Backing Sequence (Quick Record) recording procedure” on page 186 for information on the record procedure.

Page header

See “Page header” on page 177. Here, this line also shows the recognized chord.

Page menu icon

See “Page menu icon” on page 177.

Page sub-header

See “Page sub-header” on page 180.

Recording parameters area

Style

This parameter shows the selected Style. Either touch it, or press the STYLE button in the SELECTION section to open the Style Select window and select a different Style (see “Style Select window” on page 100).

Free memory

Percentage of remaining memory for recording.

Resolution

Use this parameter to set the quantization during recording. Quantization is a way of correcting timing errors; notes played too soon or too late are moved to the nearest axis of a rhythmic “grid”, set with this parameter, thus playing perfectly in time.

High No quantization applied.

♩ (1/32)... ♩ (1/8)

Grid resolution, in musical values. For example, when you select 1/8, all notes are moved to the nearest 1/8 division. When you select 1/4, all notes are moved to the nearest 1/4 division.

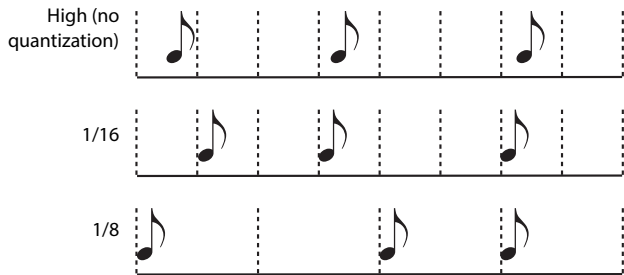

Chord/Acc Track, Kbd/Pad Track

These parameters let you define grouped track status during recording. This status is reflected by the big status indicator above the track sliders.

- Play** The Backing Sequence track is set to play. If there are recorded data, they will be heard while recording the other Backing Sequence track.
- Mute** The Backing Sequence track is muted. If this tracks has already been recorded, it will not be heard during recording of the other Backing Sequence track.
- Rec** The Backing Sequence track is in record. All previously recorded data will be deleted. After pressing ►/■ (PLAY/STOP) to start recording, the track will receive notes from the keyboard, the MIDI IN or the USB Device connector.

Chord/Acc: This Backing Sequence track groups all Style tracks, together with recognized chords and Style controls and Style Elements selection. After finishing recording, they will be saved as Song tracks 9-16, as in the following table:

Chord/Acc track	Song track/Channel
Bass	9
Drum	10
Percussion	11
Accompaniment 1	12
Accompaniment 2	13
Accompaniment 3	14
Accompaniment 4	15
Accompaniment 5	16

Kbd/Pad: This Backing Sequence track includes the four Keyboard tracks and the four Pads. After finishing recording, they will be saved as Song tracks 1-8, as in the following table:

Kbd/Pad track	Song track/Channel
Upper 1	1
Upper 2	2
Upper 3	3
Lower	4
Pad 1	5
Pad 2	6
Pad 3	7
Pad 4	8

Tempo

Metronome Tempo. Select this parameter and use the VALUE DIAL to change Tempo. You can always change Tempo using the TEMPO buttons.

Meter

(Non Editable). This parameter shows the meter (or time signature) of the selected Style for reference.

PERF or STS (Performance or STS)

This parameter shows the selected Performance or STS (depending on the latest item selected).

To select a Performance, either touch it, or press one of the PERFORMANCE buttons to open the Performance Select window and select a different Performance (see “Performance Select window” on page 102).

To select an STS (Single Touch Setting), use the four STS buttons under the display.

Backing Sequence tracks area

Backing Sequence tracks status indicators

These giant indicators show the status of the Backing Sequence tracks. They reflect the status of the Kbd/Pad and Ch/Acc parameters (see “Chord/Acc Track, Kbd/Pad Track” above).

Selected track info area

This line lets you see the Sound assigned to the selected track. See “Selected track info area” on page 178 for more information.

Track volume/status area

This area is where you can set the volume of each single Keyboard track, and mute/unmute tracks.

Sliders (track volume)

Graphical display of each track’s volume.

Individual track status icons

While you can use the Kbd/Pad Backing Sequence track to change the status of all Keyboard tracks at once, you can also change the status of each separate track. Touch this icon to change the status of the corresponding individual track.

 Play status. The track can be heard.

 Mute status. The track cannot be heard.

Track names

Under the sliders, a label for each track is shown.

Abbreviation	Track
MIC/IN	Microphone audio input
UPPER1...3	Upper tracks.
LOWER	Lower track.

Backing Sequence (Quick Record) recording procedure

Here is the general procedure to follow for the Backing Sequence (Quick) Recording.

1. Press the SEQUENCER button to enter the Song mode.
2. Press the RECORD button, and select the “Backing Sequence (Quick Record)” option to enter the Backing Sequence (Quick Record) mode. Now you can prepare your recording parameters. (For more details, see “Record mode: Backing Sequence (Quick Record) page” on page 184).
3. The latest selected Style is currently selected. If it is not the right one, select a different Style to start recording with. (See “Style Select window” on page 100).
4. The latest selected Performance or STS is currently selected. If you prefer, select a different Performance or STS. (See “Performance Select window” on page 102, and “STS Select” on page 103).

5. Select the status of the Backing Sequence tracks, by using the Kbd/Pad and Ch/Acc parameters. (Kbd/Pad stays for Keyboard and Pads; Ch/Acc stays for Chord and Accompaniment, i.e. the Style tracks). To record all you play on the keyboard, plus the automatic accompaniment, leave their status to Rec (see “Track status icons” on page 181).

Warning: Tracks set to REC are automatically overwritten when starting recording. Set a track to the PLAY or MUTE status, when you don't want to delete it. For example, if you are recording a keyboard part on an existing Style track, set the Ch/Acc parameter to PLAY, and the Kbd/Pad track to REC.

6. Start recording by pressing the left  (PLAY/STOP) button (or the START/STOP button, if you want the Style to start immediately).

- By pressing the left  (PLAY/STOP) button (or the START/STOP button), you can record a keyboard intro with no Style playing. After a count-in, start recording.

Play a solo intro, then start the auto-accompaniment by pressing the START/STOP button.

- By pressing the START/STOP button you can start the Style right at the beginning of the Song.

Since you can use any Style control, you could start with the usual combinations (INTRO, ENDING...).

Note: While in Backing Sequence mode, you can't record the SYNCHRO, TAP TEMPO/RESET, MANUAL BASS, BALANCE controls.

7. Play your music. While recording you can even change the Style, or stop it by pressing START/STOP or one of the ENDINGS. While recording you can even start the style again, by pressing START/STOP.
8. When finished recording your performance, press the  (PLAY/STOP) button in the PLAYER 1 section. You will go back to the Sequencer Play Main page (see “Sequencer Play - Main page” on page 177).

At this point, you may press the  (PLAY/STOP) button in the PLAYER 1 section to listen to the new Song.

You may also edit the Song by pressing the MENU button (see “Edit menu” on page 189).

9. Save the song to a storage device (see “Save Song window” on page 199).

Warning: The recorded Song will be deleted when the instrument enters standby, switching to the Style Play or Song Play mode, or entering Record again. If you wish to preserve it, save the Song to a storage device.

Record mode: Step Backing Sequence page

The Step Backing Sequence mode allows you to enter single chords, to create or edit the Style (Chord/Acc) part of a Song. This mode lets you enter chords even if you are not a keyboard player, or fix any error made playing chords or selecting Style controls, during a Backing Sequence (Quick Record) recording.

In this mode, you can only edit Songs created using the Backing Sequence (Quick Record) recording mode. When saving a Song created using the Backing Sequence (Quick Record) recording mode, all Chord/Acc data is preserved, and can be loaded later, to be edited again by using the Step Backing Sequence mode.

While in Sequencer mode, press the RECORD button and select the “Step Backing Sequence” option. The Step Backing Sequence window appears.

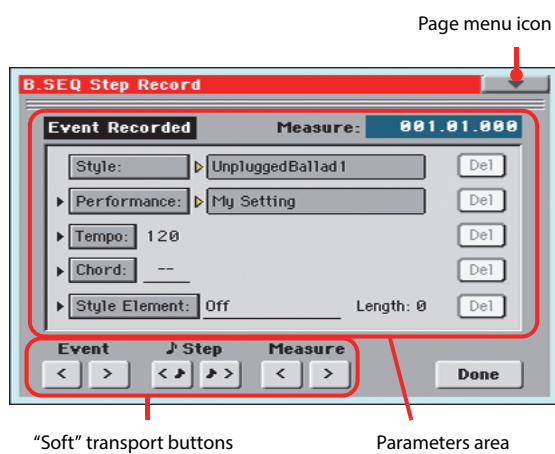

See “Step Backing Sequence procedure” on page 189 for information on the record procedure.

Page menu icon

Touch the page menu icon to open the menu. See “Step Backing Sequence page menu” on page 188 for more information.

Parameters area

Side arrow (↔)

The small arrow next to a parameter means that its value is effective at the current position. For example, if you are at the “003.01.000” position, and an arrow lights up next to the Chord parameter, this means that a chord change happens at the “003.01.000” position.

Measure

This parameter shows the current position of the Step Editor. To go to a different position within the Song, use one of the following systems:

- Select this parameter, then use the VALUE DIAL to go to a different measure.
- Use the Measure buttons in the display to move to a different measure. Use the Step buttons in the display to move in steps of 1/8 (192 ticks). Use the Event buttons in the display to jump to the next event.

The locator value is shown in the “measure.beat.tick” format.

Measure	Measure or bar number.
Beat	Divider in the Time Signature ratio (e.g., a quarter in a 3/4 time).
Tick	Smallest position value. Both Pa900 internal players feature a resolution of 384 ticks per quarter.

Style

This is the latest selected Style. To insert a Style change at the current position, touch the Style name to open the Style Select window, or follow the standard selecting procedure using the STYLE SELECT buttons.

Note: Any Style Change inserted after the beginning of the measure (i.e., to a position other than Mxxx.01.000) will be effective at the following measure. For example, if a Style Change event has been inserted at M004.03.000, the selected Style will be effectively selected at M005.01.000. (This works exactly as in Style Play mode).

Note: When inserting a Style Change, you may also insert a Tempo Change at the same position. A Style Change will not automatically insert the Style’s Tempo.

Performance

This is the latest selected Performance. Select a Performance to recall the Style it links to. To insert a Performance change at the current position, touch the Performance name to open the Performance Select window, or follow the standard selecting procedure using the PERFORMANCE section.

Note: The STYLE CHANGE LED is automatically turned on when entering the Chord/Acc Step Mode. This means that selecting a Performance automatically selects the Style memorized in the Performance.

The STS MODE and STS buttons are automatically disabled, meaning that you can’t change Keyboard tracks while in Chord/Acc Step Mode.

Tempo

This is the Tempo Change parameter. To insert a Tempo Change event at the current position, select this parameter and use the VALUE DIAL to change its value.

Chord

The chord parameter is divided in four separate parts:

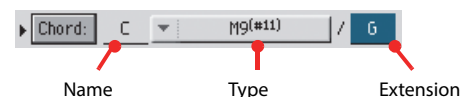

Select one of the parts, then use the VALUE DIAL to modify it. As an alternative, you can play a chord, and it will be automatically recognized. While recognizing a chord, the status of the Bass Inversion parameter will be considered.

The lack of a chord (--) means that the accompaniment will not play at the current position (apart for the Drum and Percussion tracks). To select the “--” option, select the Name part of the Chord parameter, then use VALUE DIAL to select the very last value (C...B, Off).

Note: If you replace a chord with a different one, please remember that the Lower track (if recorded) will not be automatically changed, and may cause a dissonance against the accompaniment.

Style Element

This is the Style Element (i.e., a Variation, Fill, Intro, or Ending). The length of the selected Style Element is always shown by the “Length” parameter (see below).

“Off” means that the accompaniment will not play at the selected position – only Keyboard and Pad tracks will play.

Hint: Insert a Style Element Off event exactly where the automatic accompaniment must stop (at the end of the Song).

Length

This parameter will let you know where to place the following Style Element Change. For example, if you inserted an Intro event lasting for 4 measures, you can insert 4 empty measure after this event, and a Variation event at the end of the Intro, beginning at the 4th empty measure.

Del (Delete) button

When a side arrow (↔) is shown next to a parameter, there is an event at the current position. You can touch the Del button next to it, to delete the event at the current position.

Hint: To delete all events starting from the current position, select the “Delete All from Selected” command from the page menu (see below).

“Soft” transport buttons



Use these buttons to move to the previous or next recorded event.



Use these buttons to go to the previous or next step (1/8, or 192 ticks). If an event is located before the previous or next step, the locator stops on that event. For example, if you are positioned on M001.01.000, and no event exists before M001.01.192, the > button moves to the M001.01.192 location. If an event exists on M001.01.010, the > button stops to the M001.01.010 location.

These commands are effective even if the Measure parameter is not selected.



Use these buttons to move to the previous or following measure. These commands are effective even if the Measure parameter is not selected.

Done button

Done

Touch this button to exit the Step Backing Sequence mode. All changes will be saved to memory.

Hint: Save the Song to a storage device, by selecting the “Save Song” command from the page menu, to avoid losing it when the instrument enters standby.

Step Backing Sequence page menu

Touch the page menu icon to open the menu. Touch a command to select it. Touch anywhere in the display to close the menu without selecting a command.

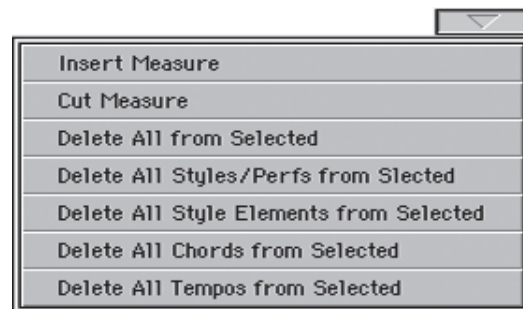

Insert Measure

Use this command to insert an empty measure starting from the current measure. All Chord/Acc events contained in the current measure will be moved to the following measure. The event at the Mxxx.01.000 position (i.e., exactly at the beginning of the measure, like a Time Signature or Style change) will not be moved.

Cut Measure

Use this command to delete the current measure. All Chord/Acc event contained in the following measures will be moved one measure back.

Delete All from Selected

Use this command to delete events of all types, starting from the current position.

Note: All events on the very first tick (M001.01.000), like Perf, Style, Tempo, Chord, Style Element selection, cannot be deleted.

Delete All Styles/Perfs from Selected

Delete All Styles Elements from Selected

Delete All Chords from Selected

Delete All Tempos from Selected

Select one of these commands to delete all events of the corresponding type, starting from the current position to the end of the Song. **To delete all events of the same type from the whole Song**, go back to the M001.01.000 position, and select one of these commands.

Note: All events on the very first tick (M001.01.000), like Perf, Style, Tempo, Chord, Style Element selection, cannot be deleted.

Step Backing Sequence procedure

Here is the general Step Backing Sequence recording procedure.

Hint: Before entering Step Backing Sequence mode to edit an existing Song, select the “Save Song” command from the page menu, and save the Song to a storage device. This way, you will have a copy of the Song, in case you don’t like the results of your editing.

1. While in Sequencer mode, press the RECORD button, and choose the “Step Backing Sequence” recording option.
2. Select the Measure parameter, and go to the desired position in the Song, by using the VALUE DIAL. Alternatively, you can move the locator using the “soft” transport buttons in the display. See “Soft” transport buttons” on page 188.
3. Select the parameter type (Style, Performance, Tempo...) to insert, edit or delete at the current position. If an arrow (▶) appears next to a parameter, the shown event has been inserted at the current position.
4. Use the VALUE DIAL to modify the selected event. Delete it by touching the Del button next to the event. When editing a parameter without the arrow (▶) next to it, a new event is inserted at the current position.
5. Exit the Step Backing Sequence recording mode, by touching the Done button in the display.
6. Press ▶/■ (PLAY/STOP) in the PLAYER 1 section to listen to the result of your editing. If it is fine, save the Song to a storage device.

Edit menu

From any page, press the MENU button to open the Sequencer edit menu. This menu gives access to the various Sequencer edit sections.

When in the menu, select an edit section, or press EXIT to exit the menu.

When in an edit page, press EXIT or the SEQUENCER button to go back to the main page of the Sequencer operating mode.

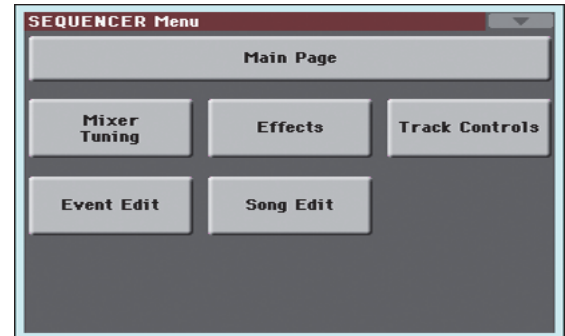

Each item in this menu corresponds to an edit section. Each edit section groups various edit pages, that may be selected by touching the corresponding tab on the lower part of the display.

Edit page structure

All edit pages share some basic elements.

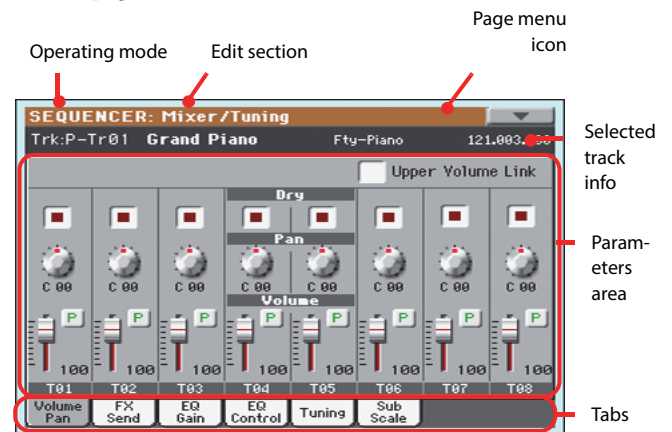

Operating mode

This indicates that the instrument is in Sequencer mode.

Edit section

This identifies the current edit section, corresponding to one of the items of the edit menu (see “Edit menu” on page 189).

Page menu icon

Touch this icon to open the page menu (see “Page menu” on page 198).

Parameters area

Each page contains various parameters. Use the tabs to select one of the pages. For detailed information on the various types of parameters, see sections starting below.

Tabs

Use tabs to select one of the edit pages of the current edit section.

Mixer/Tuning: Volume/Pan

This page lets you set the volume and pan for each Song track.

Use the TRACK SELECT button to switch between Song tracks 1-8 and 9-16.

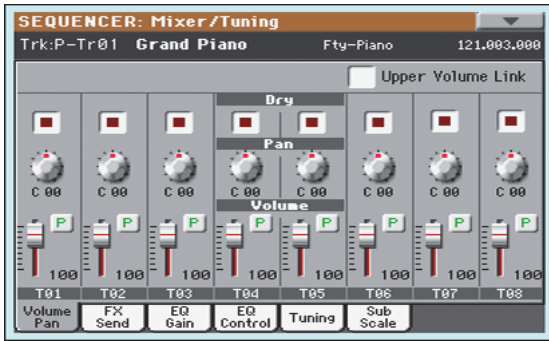

Parameters

All parameters in this page are the same found in the same page of the Song Play mode (see “Mixer/Tuning: Volume/Pan” on page 172).

Mixer/Tuning: FX Send

This page lets you set the level of the track’s direct (unaffected) signal going to the Internal FX processors.

Use the TRACK SELECT button to switch between Song tracks 1-8 and 9-16, and vice-versa.



FX Groups

Use this pop-up menu to select one of the two FX groups (A or B).

Pa900 includes two groups of effects (FX A and FX B). While in Song Play mode, the A group is reserved to the Song and Pad tracks, the B group to the Keyboard tracks.

However, Songs created in Sequencer mode could also assign the B group to the Song tracks.

Parameters

All parameters in this page are the same found in the same page of the Style Play mode (see “Mixer/Tuning: FX Send” on page 172).

Mixer/Tuning: EQ Gain

In this page you can set the three-band equalization (EQ) for each individual track.

Use the TRACK SELECT button to switch between Song tracks 1-8 and 9-16, and vice-versa.



Parameters

All parameters in this page are the same found in the same page of the Song Play mode (see “Mixer/Tuning: EQ Gain” on page 172).

Mixer/Tuning: EQ Control

This page lets you reset or bypass track equalization, programmed in the previous page.

Use the TRACK SELECT button to switch between Song tracks 1-8 and 9-16, and vice-versa.



Parameters

All parameters in this page are the same found in the same page of the Song Play mode (see “Mixer/Tuning: EQ Control” on page 173).

Mixer/Tuning: Tuning

Parameters

All parameters in this page are the same found in Global mode. See “Mixer/Tuning: Tuning” on page 116).

Mixer/Tuning: Sub Scale

This page lets you program an alternative scale for the selected tracks (via the “Track Assign” parameter). The remaining tracks (if any) use the basic scale set in Global mode (see “Main Scale” on page 257).



Note: Quarter Tone selection and activation of the Sub-Scale on each track of a Song, can be received by MIDI (i.e., by an external sequencer or controller). Conversely, selection of Quarter Tone settings, or activation of the Sub-Scale on each track of the Song, can be sent by the Pa900 to an external MIDI recorder as System Exclusive data.

Parameters



All parameters in this page are the same found in Global mode. See “Mixer/Tuning: Sub Scale” on page 117.

Track Assign

Check the parameter corresponding to each track where the Sub-Scale must be used.

Play/Mute icon

Track’s play/mute status.

-  Play status. The track can be heard.
-  Mute status. The track cannot be heard.

Effects: A/B FX Configuration

This page allows you to select the effects for the A (Song) and B (Keyboard) FX groups. You can use the “FX A” and “FX B” side tabs to switch from one group to the other one. Songs created in Sequencer mode on a Pa-Series instrument can also use the B FX group.

The effect types and the FX matrix are the same seen for the Style Play mode (see “Effects: A/B FX Configuration” on page 119).

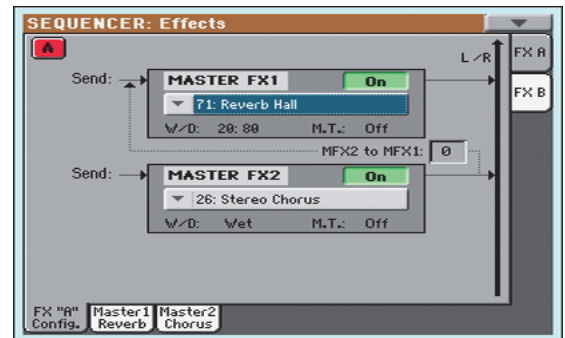

Note: When you stop the Song, or select a different Song, the default effects are selected again. You can, however, stop the Song, change the effects, then start the Song again. Save the Song to permanently change the effects.

FX Group

Use these side tabs to choose the FX group (A or B) for the corresponding track.

Pa900 includes two groups of effects (FX A and FX B). While in Song Play mode, the A group is reserved to the Song and Pad tracks, the B group to the Realtime (Keyboard) tracks.

However, Songs created in Sequencer mode could also assign the B group to the Song tracks.

Parameters

All parameters in this page are the same found in the same page of the Song Play mode (see “Effects: A/B FX Configuration” on page 173).

Effects: Master 1, 2

These pages contain the editing parameters for the effect processors. Here is an example of the FX A page, with the Reverb Hall effect assigned.

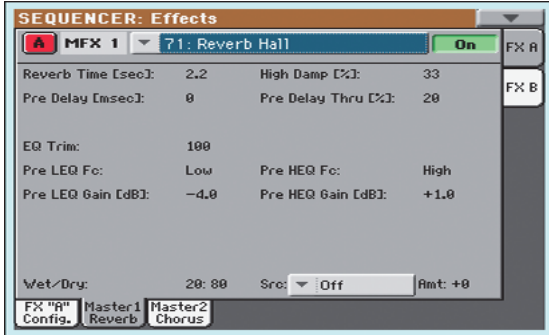

Selected effect

Select one of the available effects from this pop-up menu. This is equivalent to the “FX Group” parameters found in the “Effects: A/B FX Configuration” page (see above).

Parameters

The parameters shown in this page are the same already seen for the Style Play mode. See “Effects: Master 1, 2” on page 119 for details.

Track Controls: Mode

Parameter

See “Track Controls: Mode” on page 120.

Track Controls: Drum Edit

Parameter

See “Track Controls: Drum Edit” on page 121.

Track Controls: Easy Edit

Parameter

See “Track Controls: Easy Edit” on page 122.

Event Edit: Event Edit

The Event Edit is the page where you can edit each single MIDI event of the selected track. You can, for example, replace a note with a different one, or change its playing strength. See also “Event Edit procedure” on page 193 for more information on the event editing procedure.

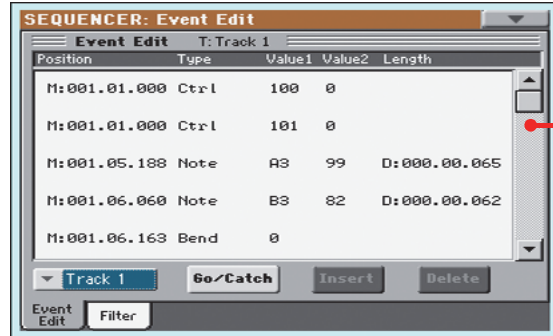

Scroll bar

Position

Position of the event, expressed in the form ‘aaa.bb.ccc’:

- ‘aaa’ is the measure
- ‘bb’ is the beat
- ‘ccc’ is the tick (each quarter beat = 384 ticks)

You can edit this parameter to move the event to a different position. You can edit a position in either of the following ways:

- select the parameter, and use the VALUE DIAL to change the value, or
- select the parameter, then touch it again; the numeric keypad will appear. Enter the new position by dialing in the three parts of the number, separated by a dot. Zeroes at the beginning can be omitted, as well as the least important parts of the number. For example, to enter position 002.02.193, dial “2.2.193”; to enter position 002.04.000 dial “2.4”; to enter position 002.01.000, simply dial “2”.

Type

Type of the event shown in the display. To edit it, select the parameter and use the VALUE DIAL to change its value.

This parameter also shows the (non editable) “End Of Track” marking, when the end of the track is reached.

Value 1 and 2

Values of the event shown in the display. Depending on the selected event, the meaning may change.

Here are the events contained in ordinary tracks (1-16).

Type	First value	Second value
Note	Note name	Velocity
RX Noise	Note name	Velocity
Prog	Program Change number	–
Ctrl	Control Change number	Control Change value
Bend	Bending value	–
Aftt	Mono (Channel) Aftertouch value	–
PAft	Note to which the Aftertouch is applied	Poly Aftertouch value

And here are the events contained in the Master track.

Type	First value	Second value
Tempo	Tempo change	–
Volume	Master Volume value	–
Meter	Meter (time signature) change ^(*)	–
KeySign	Key Signature ^(†)	–
Scale	One of the available preset Scales	Root note for the selected Scale
UScale (User Scale)	Altered note	Note alteration ^(‡)
QT (Quarter Tone)	Altered note	Note alteration (0, 50) ^(b)
QT Clear (Quarter Tone Clearing)	Reset of all Quarter Tone (QT) changes	–

(*) Meter changes can't be edited or inserted separately from a measure. To insert a Meter change, use the Insert function in the Edit section and insert a series of measures with the new meter. Existing data can then be copied or entered to these measures

(†) This is the key signature shown in the Score. If this event is missing, the Score will be shown as if it was in the key of C Major.

(‡) To edit User Scale and Quarter Tone settings, select the first value, then select the scale's degree to edit. Edit the second value to change the tuning of the selected note of the scale.

To edit the event Type and Values, select the parameter and use the VALUE DIAL to change their value. In case of numeric values, you can also press them twice to open the numeric keypad.

Length

Length of the selected Note event. The value format is the same as the Position value. Edit it in the same way.

Note: If you change a length of "000.00.000" to a different value, you can't go back to the original value. This rather uncommon zero-length value may be found in the drum and percussion tracks of Songs made in Backing Sequence mode.

Track

Use this pop-up menu to select the track to edit.

Track 1...16 One of the ordinary tracks of the Song. These tracks contains musical data, like notes and controllers.

Master This is a special track, containing Tempo changes, Meter changes, Scale and Transpose data, and the effect parameters.

Scrollbar

Use the scrollbar to browse the event through the list. You can also scroll by using the SHIFT + DIAL combination.

Go/Catch

This is a dual-function command.

- While the sequencer is not running, it works as a Go to Measure command. Touch it to open the Go to Measure dialog box:



When in this dialog box, select a target measure, and touch OK. The first event available in the target measure will be selected.

- While the sequencer is running, it works as a Catch Locator command. Touch it to show the event that is currently playing.

Insert

Touch the Insert button in the display to insert a new event at the current shown Position. The default values are Type = Note, Pitch = C4, Velocity = 100, Length = 192.

Note: You can't insert new events in an empty, non-recorded Song. To insert an event, you must first insert some empty measures by using the Insert Measure function (see "Song Edit: Cut/Insert Measures" on page 196).

Delete

Touch the Delete button in the display to delete the event selected in the display.

Note: The "End of Track" event cannot be deleted.

Event Edit procedure

Here is the general event editing procedure.

1. While in the Event Edit page, press ►/■ (PLAY/STOP) in the PLAYER 1 section to listen to the Song. Press it again to stop the Song.
2. Select the Filter page, and turn "Off" the filter for the event types you wish to see in the display (see "Event Edit: Filter" on page 194 for more information).
3. Return to the Event Edit page.
4. Use the "Track" pop-up menu to select the track to edit. The list of events contained in the selected track will appear in the display.

For more information on the event types and their values, see above.

5. Select the "Position" parameter. Use the VALUE DIAL (or touch the parameter again to open the numeric keypad) to change the event's position.
6. Select the "Type" parameter and use the VALUE DIAL to change the event type. Select the "Value 1 and 2" parameters and use the VALUE DIAL (or touch the parameter again to open the numeric keypad) to modify the selected value.

7. In the case of a Note event, select the Length parameter, and use the VALUE DIAL (or touch the parameter again to open the numeric keypad) to change the event's length.
 - While the sequencer is not running, you may touch the Go/Catch button in the display to go to a different measure (see "Go/Catch" above)
 - While the sequencer is running, you may use the Go/Catch button in the display to see the currently playing event in the display (see "Go/Catch" above).
 - Use the PLAYER 1 transport controls to listen to the Song.
8. Touch the Insert button in the display to insert an event at the Position shown in the display (a Note event with default values will be inserted). Touch the Delete button in the display to delete the selected event.
9. When the editing is complete, you may select a different track (go to step 4).
10. When finished editing the whole Song, select the Save Song command from the page menu to save the Song to a storage device. See "Save Song window" on page 199 for more information on saving a Song.

Event Edit: Filter

This page is where you can select the event types to be shown in the Event Edit page.

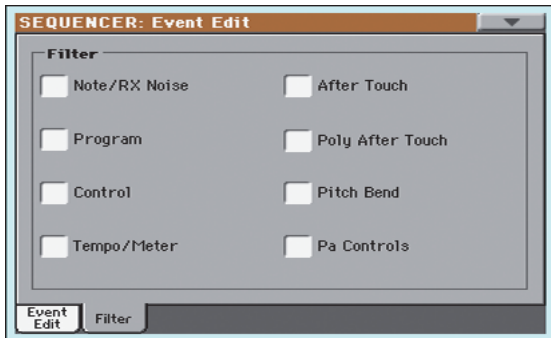

Turn On the filter for all event types you do not wish to see in the Event Edit page.

- Note/RX Noise Notes and RX Noises.
- Program Program Change events.
- Control Control Change events.
- Tempo/Meter Tempo and Meter (time signature) changes (Master Track only).
- After Touch Mono (Channel) Aftershow events.
- Poly After Touch Poly Aftershow events.
- Pitch Bend Pitch Bend events.

Pa Controls Controls exclusive to Pa900, like the Scale settings. These controls are recorded to the Master Track, and saved as System Exclusive data.

Song Edit: Quantize

The quantize function corrects any rhythm error after recording.

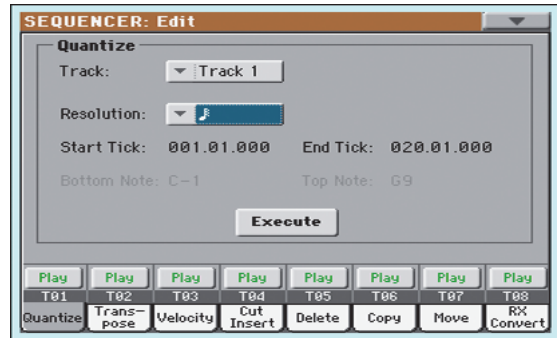

After setting the various parameters, touch Execute to start the operation.

Track

Use this parameter to select a track.

- All Quantize will apply to all tracks.
- Track 1...16 Quantize will apply only to the selected track.

Resolution

This parameter sets the quantization value. For example, when you select a 1/8-note, all notes are moved to the nearest 1/8 division. When you select 1/4, all notes are moved to the nearest 1/4 division.

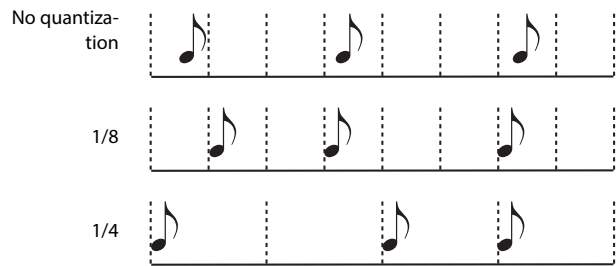

♩ (1/32)... ♩ (1/4)

Grid resolution, in musical values. A "b...f" character added after the value means swing-quantization. A "3" means triplet.

Start / End Tick

Use these parameters to set the starting and ending points of the range to be quantized.

If you wish to select a four-measure sequence starting at the beginning of the Song, the Start will be positioned at 1.01.000, and the End at 5.01.000.

Bottom / Top Note

Use these parameters to set the bottom and top note of the keyboard range to quantize. If you select the same note as the Bottom and Top parameters, you can select a single percussive instrument in a Drum track.

Note: These parameters are available only when a Drum track is selected.

Song Edit: Transpose

Here you can transpose the Song, a track or a part of a track.



After setting the various parameters, touch Execute to start the operation.

Track

Use this parameter to select a track.

All All tracks selected (apart for Drum tracks).

Track 1...16 Selected track.

Value

Transpose value (± 127 semitones).

Start / End Tick

Use these parameters to set the starting and ending points of the range to transpose.

If you wish to select a four-measure sequence starting at the beginning of the Song, the Start will be positioned at 1.01.000, and the End at 5.01.000.

Bottom / Top Note

Use these parameters to set the bottom and top of the keyboard range to transpose. If you select the same note as the Bottom and Top parameters, you can select a single note, or a single percussive instrument in a Drum track.

Song Edit: Velocity

Here you can change the Velocity value for the notes. An Advanced mode is available, allowing you to select a velocity curve for the selected range. This is useful to create fade-ins or fade-outs.

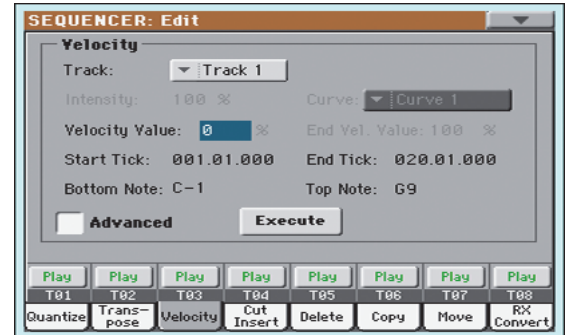

After setting the various parameters, touch Execute to start the operation.

Track

Use this parameter to select a track.

All All tracks selected.

Track 1...16 Selected track.

Value

Velocity change value.

Start / End Tick

Use these parameters to set the starting and ending points of the range to edit.

If you wish to select a four-measure sequence starting at the beginning of the Song, the Start will be positioned at 1.01.000, and the End at 5.01.000.

Bottom / Top Note

Use these parameters to set the bottom and top of the keyboard range to edit. If you select the same note as the Bottom and Top parameters, you can select a single percussive instrument in a Drum track.

Advanced

When this checkbox is checked, the "Intensity", "Curve", "Start Velocity Value" and "End Velocity Value" parameters can be edited.

Intensity

(Only available in Advanced mode). Use this parameter to specify the degree to which the velocity data will be adjusted toward the curve you specify in "Curve".

0...100% Intensity value. With a setting of 0 [%], the velocity will not change. With a setting of 100 [%], the velocity will be changed the most.

Curve

(Only available in Advanced mode). Use this parameter to select one of the six curves, and to specify how the velocity will change over time.

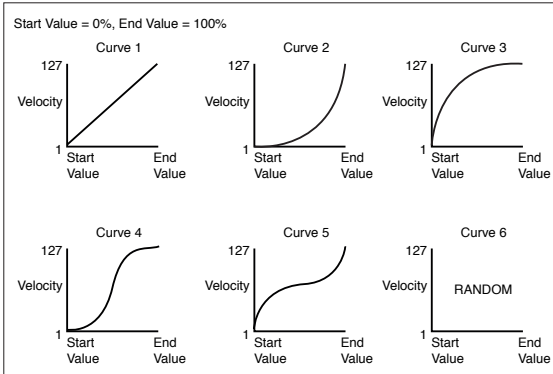

Start / End Vel. Value

(Only available in Advanced mode). Velocity change at the starting and ending ticks of the selected range.

0...100 Velocity change in percentage.

Song Edit: Cut/Insert Measures

In this page you can cut or insert measures from the Song.

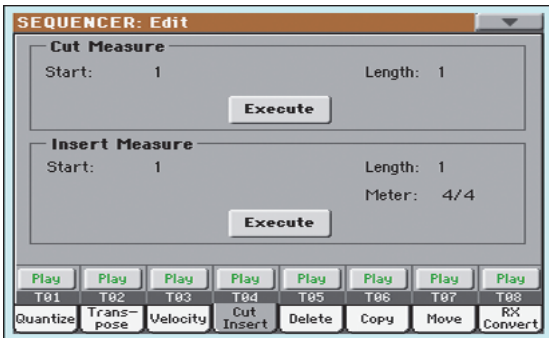

After selecting the Start and Length parameters, touch Execute to start the operation.

After the Cut, the following measures are moved back, to fill the cut measures.

After the Insert, the following measures are pushed forward to accommodate the inserted measures.

Start

First measure where to begin cutting/inserting.

Length

Number of measures to be cut/inserted.

Meter

Meter (time signature) of the measures to be inserted.

Song Edit: Delete

This page is where you can delete MIDI events from the Song.



After setting the various parameters, touch Execute to start the operation.

Track

Use this parameter to select a track.

- All All tracks selected.
- Track 1...16 Selected track.
- Master Master track. This is where the Tempo, Scale and Effect events are recorded.

Event

Type of MIDI event to delete.

- All All events. Measures will not be removed from the Song, and will remain empty.
- Note All notes in the selected range.
- Dup.Note All duplicate notes. When two notes with the same pitch are encountered on the same tick, the one with the lowest velocity is deleted.
- After Touch After Touch events.
- Pitch Bend Pitch Bend events.
- Prog.Change Program Change events, excluding the bundled Control Change #00 (Bank Select MSB) and #32 (Bank Select LSB).
- Ctl.Change All Control Change events, for example Bank Select, Modulation, Damper, Soft Pedal...
- CC00/32...CC127 Single Control Change events. Double Control Change numbers (like 00/32) are MSB/LSB bundles.

Start / End Tick

Use these parameters to set the starting and ending points of the range to edit.

If you wish to select a four-measure sequence starting at the beginning of the Song, the Start will be positioned at 1.01.000, and the End at 5.01.000.

Bottom / Top Note

Use these parameters to set the bottom and top of the keyboard range to delete. If you select the same note as the Bottom and

Top parameters, you can select a single note, or a single percussive instrument in a Drum track.

Note: These parameters are available only when the All or Note options are selected.

Song Edit: Copy

Here you can copy tracks or phrases.

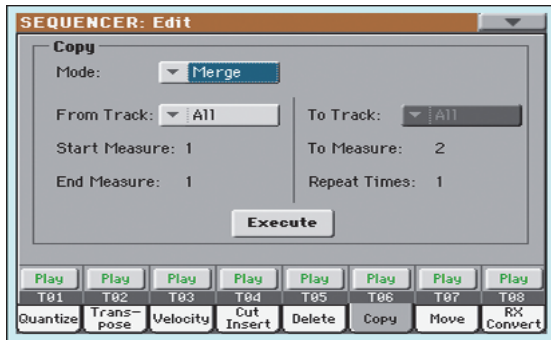

After setting the various parameters, touch Execute to start the operation.

Note: If you copy too many events on the same “tick”, the “Too many events!” message appears, and the copy operation is aborted.

Mode

Use this parameter to select the Copy mode.

Merge Copied data are merged with the data at the target position.

Overwrite Copied data replace all data at the target position.
Warning: Deleted data cannot be recovered!

From Track... To Track

Use these parameters to select the source and target track to copy.

All All tracks. The target track cannot be selected.

Track 1...16 Selected source and target tracks.

Start Measure... End Measure

These parameters are the starting and ending measure to copy. For example, if From Measure=1 and To Measure=4, the first four measures are copied.

To Measure

This parameter is the first of the target measures.

Repeat Times

Number of times the copy must be executed. Copies will be consecutive.

Song Edit: Move

Here you can shift a track forward or backward by just a few ticks or whole measures.



After setting the various parameters, touch Execute to complete the operation.

Track

Use these parameters to select the track you want to move.

Track 1...16 Selected track.

Start / End Tick

These parameters set the starting and ending point of the range to move.

To Tick

This parameter allows you to set the target starting point of the moved track.

Song Edit: RX Convert

You can use the RX Convert page to convert notes of the midifile into RX Noises, and vice-versa. This will help programming Songs on an external sequencer.



After having chosen a track to convert, touch Execute to complete the operation.

Track

Use these parameters to select the track containing the notes or RX Noises you want to convert.

RX Note Velocity

Use this parameter to adjust the volume level of the RX Noises in the selected track(s).

Add RX Noises to Guitar track

Use this parameter to automatically analyze the Standard MIDI File, and add RX Noises to Guitar tracks. This command scans a single track or the whole Standard MIDI File, looking for guitar strumming played by nylon, steel or electric guitars.

After scanning, a suitable Guitar sound will be automatically assigned to the relevant tracks, and RX Noises automatically added where needed.

Convert RX Noises to MIDI Notes

Use this parameter to convert the RX Noises contained in the selected track to ordinary MIDI Notes.

Convert MIDI Notes to RX Noises

Use this parameter to convert all the relevant MIDI Notes in the selected track to RX Noises.

Page menu

Touch the page menu icon to open the menu. Touch a command to select it. Touch anywhere in the display to close the menu without selecting a command.

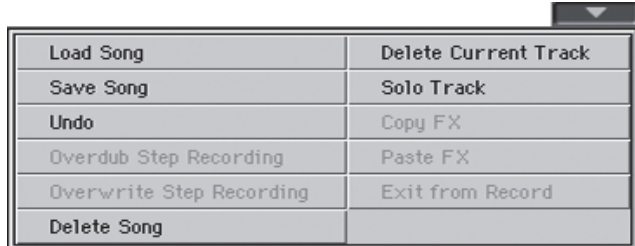

Load Song	Delete Current Track
Save Song	Solo Track
Undo	Copy FX
Overdub Step Recording	Paste FX
Overwrite Step Recording	Exit from Record
Delete Song	

Load Song

Select this command to open the Song Select window, and load a Song to the sequencer. (See “Song Select window” on page 199).

Save Song

Select this command to save the new or edited Song to a storage device as a Standard MIDI File. The file is automatically added the “.MID” extension. After selecting this command, the Save Song page appears (see “Save Song window” on page 199).

Warning: Turning the instrument off will delete the Song from memory. Save your Song to a storage device to avoid losing it.

Warning: The Song is also lost when switching from Sequencer to Style Play or Song Play mode, without previously saving the Song to a storage device.

Undo

When selecting this command, the latest operation is canceled, and data are reverted to the previous situation.

Overdub Step Recording

Only available in Record mode. Select this command to enter Overdub Step Record mode. This recording mode lets you enter events one at a time, adding events to the existing events. (See “Record mode: Step Record page” on page 182).

Overwrite Step Recording

Only available in Record mode. Select this command to enter Overwrite Step Record mode. This recording mode lets you enter events one at a time, overwriting all existing events. (See “Record mode: Step Record page” on page 182).

Delete Song

Select this command to delete the Song and create a new, blank Song.

Delete Current Track

Select this command to delete the track currently selected in the Track area (see “Track volume/status area” on page 181).

Solo Track

Select the track to be soloed, and check this item. You will hear only the selected track, and the ‘Solo’ warning will flash on the page header.

Uncheck this item to exit the Solo function.

[SHIFT] Keep the SHIFT button pressed and touch one of the tracks to solo it. Do the same on a soloed track to deactivate the Solo function.

Copy/Paste FX

Use this command to copy a single effect, or both effects of an FX group (A or B). See “Copy/Paste FX” on page 127 for detailed instructions.

Exit from Record

Only available in Record mode. Select this command to exit the Record mode, and go back to the Main page of the Sequencer Play mode (see “Sequencer Play - Main page” on page 177).

Song Select window

This window appears when you select the “Load Song” command from the page menu, or press the SELECT button in the PLAYER 1 section of the control panel. See “Song Select window” on page 103 for details.

Save Song window

The recorded Song is lost when the instrument enters standby. **The Song is also lost when you overwrite it in Record mode, or if you confirm the warning message when switching to the Style Play or Song Play mode.** You must save to a storage device any Song you wish to preserve.

This window appears when you select the “Save Song” command from the page menu.

Press EXIT to cancel saving and go back to the main page of the Sequencer operating mode.

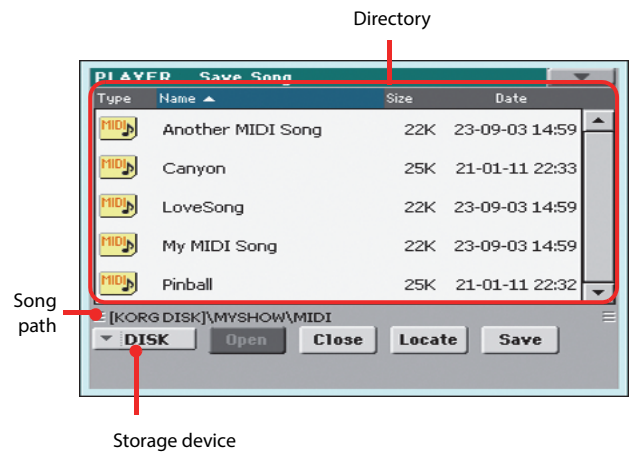

Song path

This line shows the path of the location where you are saving the Song.

Directory

This is the list of the selected device’s content.

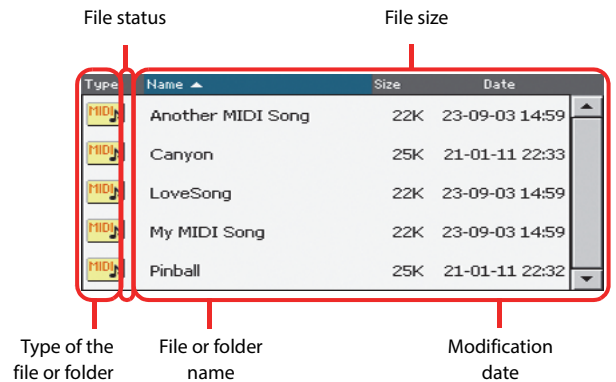

Detailed information about this type of page can be read in “Song Select window” on page 103.

Storage device

Use this menu to select one of the available storage devices.

Device	Type
DISK	Internal memory
SD	Optional device inserted in the microSD slot
USB	Optional device connected to the USB Host port

The actual name (label) of the device appears within square brackets ([]).

Open

Opens the selected folder (item whose icon looks like this:).

Close

Closes the current folder, returning to the parent (“upper”) folder.

Locate

Touch this button to see the Song assigned to the Sequencer. This is useful to quickly locate it, after you have browsed through long directories and “dug” into different folders.

Save

Touch this button to open the Save Song dialog box, and save the Song to the current directory.

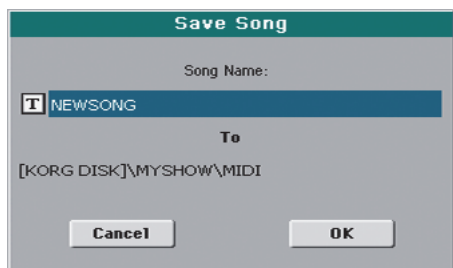

- If no file has been selected in the display, prior to touching Save, the “NewSong” default name will be automatically assigned to the Song.

Note: If a file is selected, just touch the storage device name to deselect it.

- If a file has been selected in the display, prior to touching Save, the name of the selected file will be automatically assigned to the Song.

In any of the above situations, touch the **T** (Text Edit) button to edit the Song name.

Warning: If a file with the same name is already in the current directory, a message will warn you. If you confirm, the existing file will be overwritten. Select a file before saving only if you want to overwrite it (i.e., in case you are saving changes to an existing file).

Empty measure at the beginning of the Standard MIDI File

When saving a Song as a Standard MIDI File, an empty measure is automatically inserted to the beginning of the Song. This measure contains various Song initialization parameters.

Play/Mute status saved with the Song

When saving a Song, the Play/Mute status is saved with the Song. This status is preserved also when playing back the same Song in Song Play mode.

Master Transpose saved with the Song

When saving a Song, the Master Transpose value is saved with the Song. Since this value is saved as System Exclusive data, it is preserved also when playing back the Song in Song Play mode.

Hint: Since the Master Transpose is a global parameter, loading a Song with a non-standard transposition may result in unwanted transposing when loading other Songs that do not contain their own transposition data. To transpose a Song it is advisable to use the Transpose function in the Edit section of the Sequencer mode (see “Song Edit: Transpose” on page 195).

You may also lock the Master Transpose, to avoid unwanted transposition. See “General Controls: Lock” on page 249 of the Global chapter.

As a general rule, you should use the Master Transpose (TRANSPPOSE buttons on the control panel) when you need to transpose Keyboard tracks together with the Song. You should use the Edit mode Transpose function (see “Song Edit: Transpose” on page 195) when only the Song has to be transposed.

Note: The Master Transpose value is always shown on the page header:



Save Song procedure

1. If you are in Record mode, stop the sequencer and exit from the Record mode. Then go back to the main page of the Sequencer Play mode (see “Sequencer Play - Main page” on page 177).
2. Select the Save Song command from the page menu. The Save Song page appears.
3. Select the folder where you want to save the Song into. Use the Open and Close commands to browse open or close folders. Use the scrollbar to browse through the files.
4. When you are in the directory where you want to save your Song to, touch the Save button in the display.
 - To **overwrite** an existing file, select it before touching Save.
 - To **create** a new file, do not select any file before touching Save. The “NewSong” (“NEWSONG.MID” on a storage device) name will be automatically assigned to the Song.
5. After touching the Save button, the Save Song dialog box will appear.
6. If you like, touch the **T** (Text Edit) button to edit the name.
7. Touch OK to confirm saving, or Cancel to stop the Save operation.

Sound mode

The Sound operating mode is where you can listen to individual Sounds, and edit them. In this mode, the selected Sound can always be played across the full keyboard range.

Details on how to select a Sound are included in the “Selecting elements” chapter (see “Sound Select window” on page 101).

While in a different operating mode, you can easily select the Sound to be edited when switching to the Sound mode. Just select the track the Sound to be edited is assigned to, then keep the SHIFT button pressed while pressing the SOUND button.

Hint: This is also useful to see the Bank Select/Program Change numbers when programming a Song on an external sequencer.

The MIDI channel

In Sound mode, Pa900 receives and transmits on the same channel of the Upper 1 track. If the Global channel is assigned, notes can also be received on this channel. See “MIDI: MIDI In Channels” on page 260 and “MIDI: MIDI Out Channels” on page 261 for more information.

How to select oscillators

While in an edit page requiring an oscillator to be selected for editing, use the vertical row of buttons on the right (1...24 max) to select one of the available oscillators. The number of available oscillators depends on the “Oscillators Count” parameter (see page 205).

If you cannot see the desired oscillator, touch the scroll arrow, until the hidden oscillator is shown in the display.

When oscillators cannot be select, since the parameter contained in the current page are global and valid for the whole Sound, these buttons are greyed out, and cannot be selected.



Sounds, Drum Kits, Digital Drawbars

Pa900 features three different types of Sounds:

- Ordinary Sounds. These are normal instrument Sounds, like pianos, strings, basses.
- Drum Kits. These are drum and percussion kits, where each note of the keyboard is a different percussive instrument. You can find Drum Kits in the Drum & SFX and User Dk banks.
- Digital Drawbars. These are Sounds with a very complex structure, and a special usage, whose settings are saved into a Performance. See “Digital Drawbars page” on page 203 for more information.

Before pressing MENU to access the edit pages, you should select a Sound of the type you wish to edit or create.

Note: Notes pointing to special Drum Kit features are marked by the **DRUM** icon.

Main page

Here is the main page of the Sound operating mode.

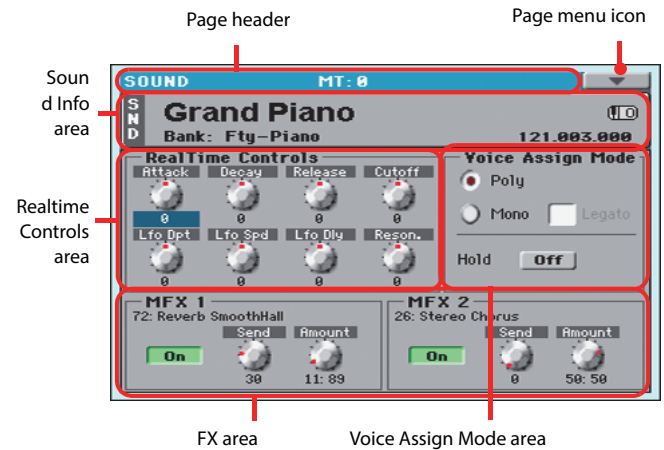

Page header

This line shows the current operating mode and transposition.



Operating mode name

Name of the current operating mode.

Master transpose

Master transpose value in semitones. This value can be changed using the TRANSPOSE buttons on the control panel.

Page menu icon

Touch the page menu icon to open the menu. See “Page menu” on page 227 for more information.



Sound Info area

This is where basic details for the Sound are shown. Touch anywhere in this area to open the Sound Select window.

Sound name

Name of the Sound assigned to the corresponding Keyboard track.

Bank

Bank the current Sound belongs to.

Bank Select / Program Change sequence

Bank Select MSB / Bank Select LSB / Program Change numbers, in the form “CC00.CC32.PC”.

CC00	This section shows the value of the Control Change (CC) 00 message (or Bank Select MSB) for the selected Sound.
CC32	This section shows the value of the Control Change (CC) 32 message (a.k.a. Bank Select LSB) for the selected Sound.
PC	This section shows the value of the Program Change (PC) message for the selected Sound. Values are in the standard 0-127 MIDI numbering format. <i>Note: Some manufacturers could use the 1-128 numbering system; when connecting your Pa900 to an instrument of this kind, increment the PC value by 1 unit.</i>

Octave Transpose icon

Octave transpose value. Use the UPPER OCTAVE buttons to change this value.

Realtime Controls area

Controls in this area allow you to edit the main parameters of the Sounds assigned to each track. Touch one of them, and modify its value by using the VALUE DIAL controls (or moving your finger).

Note: All values refer to the original values of the Sound.

Note: When selecting the Write Sound command from the page menu, current parameter values, after editing the Realtime Controls, are saved with the Sound. After saving, Realtime Controls are set back to the default position.

Note: After selecting a different Sound, Realtime Control values are automatically set to zero.

Attack	Attack time. This is the time during which the sound goes from zero (at the moment when you strike a key) to its maximum level.
Decay	Decay time. Time to go from the final Attack level to the beginning of the Sustain.
Release	Release time. This is the time during which the sound goes from the sustaining phase, to zero. The Release is triggered by releasing a key.
Cutoff	Filter cutoff. This sets the sound brightness.
LFO Depth	Intensity of the Vibrato (LFO).
LFO Speed	Speed of the Vibrato (LFO).
LFO Delay	Delay time before the Vibrato (LFO) begins, after the sound starts.
Resonance	Use the Filter Resonance to boost the cutoff frequency.

Voice Assign Mode

Poly

The Sound will play polyphonically, allowing you play chords.

Mono

The Sound will play monophonically, producing only one note at a time.

Legato

This parameter is available when the Mono option is selected.

Note: If “Legato” is On, certain multisamples or keyboard locations may produce an incorrect pitch.

On Legato is on. When multiple note-on's occur, the first note-on will retrigger the sound, and the second and subsequent note-on's will not retrigger.

When legato is on, multiple note-on's will not retrigger the voice. If one note is already on and another note is turned on, the first voice will continue sounding. The oscillator sound, envelope, and LFO will not be reset, and only the pitch of the oscillator will be updated. This setting is effective for wind instrument sounds and analog synth-type sounds.

Off Legato is off. Notes will always be retriggered when note-on occurs.

When legato is off, multiple note-on's will retrigger the voice at each note-on. The oscillator sound, envelope, and LFO will be reset (and retriggered) according to the settings of the Sound.

Hold

Use this parameter to keep the notes sustained even after releasing the keys.

Note: Please remember the Hold must be On before playing the note to be held.

FX Area

In Sound mode, two Master effect processors (MFX1 and MFX2) are available.

On/Off

Use this button to turn on or off the corresponding effect.

Selected Effect

Non editable. This shows the effect assigned to the corresponding FX processor. To select a different effect, see “Effects: “B” FX Config” on page 226.

Send

Use this knob to adjust the level of the dry sound sent to the corresponding effect.

Amount

Volume of the effect that is added to the dry (non-effected) signal.

Digital Drawbars page

DIGITAL DRAWBARS are different from ordinary Sounds. Their parameters are not saved as a new Sound, but can be saved to a Performance. Therefore, when entering the Digital Drawbars page, the MENU button is disabled.

Note: In Style Play and Backing Sequence mode, only a Digital Drawbar Sound is available for the Keyboard tracks, and one for the Style tracks. Save them to a Performance (see “Write Performance dialog box” on page 128).

Note: In Song Play mode, there is a Digital Drawbars Sound for the Keyboard tracks, one for Song tracks 1-8, another one for Song tracks 9-16.

Note: In Sequencer mode there is a Digital Drawbars Sound for Song tracks 1-8, one for Song tracks 9-16.

When you select the special DRAWBARS Sound in the Organ Sound bank, the Drawbars Setting page appears, and the current setting is assigned to the selected track.

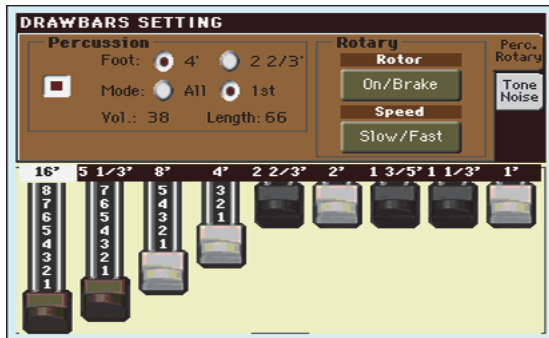

To edit the Drawbars, drag the virtual sliders in the display. As an alternative, touch a slider and drag it on the display, or use the VALUE DIAL controls to change its value.

Each foot refers to the pipe length in a pipe organ, in which the sound is produced by pipes of different length. Longer pipes mean a lower sound; therefore, the 16' drawbar produces the lowest pitched sound, while the 1' drawbar produces the highest pitched sound.

Percussion/Rotary tab

Percussion adds a percussive sound to the attack segment of the organ sound. Rotary adds the effect of a rotating speaker.

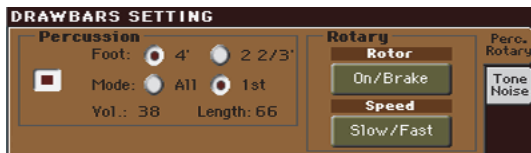

On/Off

Use this parameter to turn percussion on or off.

Foot

Use this parameter to select a percussion register.

- 4' Percussion added to the 4' foot.
- 2 2/3' Percussion added to the 2 2/3' foot.

Mode (Percussion Mode)

This parameters lets you decide if the percussion sound has to be triggered on the first note of a group of held notes, or to all notes.

- All The percussive attack is played on all notes of a chord.
- 1st The percussive attack is played only on the first note of a chord or a group of held notes. Release all notes to trigger the percussion again.

Volume (Percussion Volume)

Level of the percussive sound.

- 0...99 Level.

Length (Percussion Length)

Decay speed of the percussive sound.

- 0...99 Decay time.

Rotor On/Brake

Touch this button to start or stop the rotating speaker.

Speed Slow/Fast

Touch this button to switch the rotating speaker's speed (from slow to fast, or vice-versa).

Note: The “Rotor On/Brake” and “Speed Slow/Fast” parameters are only available when a Rotary effect has been assigned to one of the FX slots (effects #63 or #133).

Tone/Noise tab

Tone is the timbre of the sound. Noises are mechanical noises from the keyboard and the tonewheels.



Wave (Drawbar Wave)

Tone

Waveshape of the drawbars, producing the base timbre.

- Mellow A mellow-sounding synthetic wave.
- Hard A harder-sounding synthetic wave.

Leakage

Leakage from adjacent tonewheels, making the sound richer.

Key On

Noise of the keypress.

Key Off

Noise of the key release.

Edit menu

From any page, press the MENU button to open the Sound edit menu. This menu gives access to the various Sound edit sections.

When in the menu, select an edit section, or press EXIT or SOUND to exit the menu and return to the main page. To return to the main page, you can also select the Main Page menu item.

When in an edit page, press EXIT or the SOUND button to return to the main page of the Sound operating mode.

- When an ordinary Sound is selected:



- When a Drum Kit is selected, the “Basic” section is replaced by the “DrumKit” section:



Each item in this menu corresponds to an edit section. Each edit section groups various edit pages, that may be selected by touching the corresponding tab on the lower part of the display.

Edit page structure

All edit pages share some basic elements.

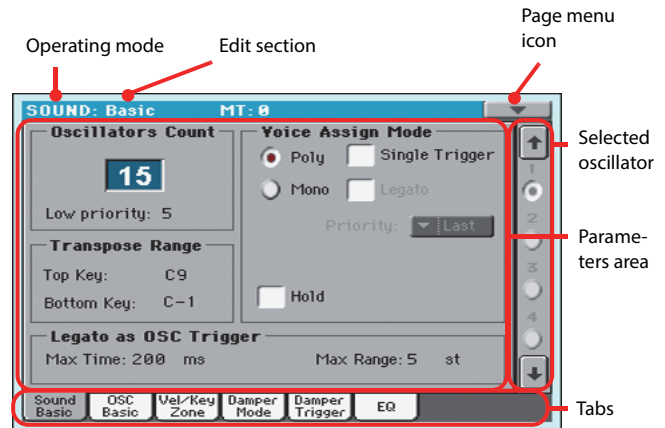

Operating mode

This indicates that the instrument is in Sound mode.

Edit section

This identifies the current edit section, corresponding to one of the items of the edit menu (see “Edit menu” on page 204).

Page menu icon

Touch this icon to open the page menu (see “Page menu” on page 227).

Selected oscillator

Use these buttons to select the oscillator to edit.

Parameters area

Each page contains various parameters. Use the tabs to select one of the available pages. For detailed information on the various types of parameters, see sections starting from page 204.

Tabs

Use tabs to select one of the edit pages of the current edit section.

Basic: Sound Basic

Here you can make basic settings for the Sound, such as basic oscillator settings, the oscillator count, and the polyphonic mode.

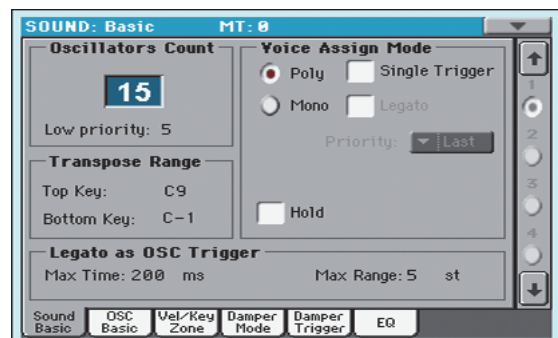

Oscillator Count

Oscillators Count

Use this box to specify the number of oscillators (up to 24) the Sound is based on.

The total amount of polyphony varies depending on the number of oscillators used by the Sound (a maximum of 128 with only 1 oscillator per voice).

Note: When editing the Grand Piano sound, keep in mind Oscillators 10~15 can only be heard when the Damper pedal is depressed.

Low priority

Use this parameter to decide if the highest-numbered oscillators must be turned off when more polyphony voices are needed. Keep in mind that, with a dense polyphony, missing oscillators might not even be heard.

- 0 No oscillator will be turned off in any case.
- 1 The highest-numbered oscillator will be turned off, if needed.
- 2 The two highest-numbered oscillators can be turned off, one after the other, if needed.
- [n]...24 The n-numbered oscillators (up to 24) can be turned off, one after the other, if needed.

Transpose Range

Top/Bottom Key

Use these parameters to set a range for transposition. Inside this range notes are transposed. Outside this range, they are not transposed. This is useful to avoid RX Sounds being transposed when transposing a Sound.

Note: Set these (general) values so that all RX Noises assigned to any Oscillator fall out of the Transpose Range. For example, if you assigned an RX Noise to a G7 on OSC1, and an RX Noise to an A7 on OSC2, set the "Top Key" value no higher than F#7 (just below the lowest RX Noise).

Voice Assign Mode

Poly/Mono

This is the polyphonic mode of the Sound.

- Poly The Sound will play polyphonically, allowing you to play chords.
- Mono The Sound will play monophonically, producing only one note at a time.

Single Trigger

This parameter is available when the selected mode is Poly.

- On When the same note is played repeatedly, the previous note will be silenced before the next note is sounded, so that the notes do not overlap.
- Off When the same note is played repeatedly, the previous note will not be silenced before the next note is sounded.

Legato

This parameter is only available when the selected mode is Mono. It is the same found on the main page of the Sound mode.

See "Legato" on page 202 for information on this parameter.

Priority

This parameter is available when the selected mode is Mono. It specifies which note will be given priority to play when two or more notes are played simultaneously.

- Low Lowest note will take priority.
- High Highest note will take priority.
- Last Last note will take priority.

Hold

Use this parameter to keep the notes sustained even after releasing the keys.

Legato as OSC Trigger

The parameters included in this section are to be considered when a note is played 'legato', i.e., with no gap with the previous note. These parameters are valid for the whole Sound (all oscillators).

Max Time

This delay allows notes to be considered Legato, even if there is a small gap before them. This is useful to avoid some notes in a chord are played Legato, and some others Staccato.

- 1...999 ms Notes played with a small gap are still considered Legato notes. A value of approx. 15 ms is usually considered effective when playing chords.

Max Range

This is the range (in semitones) within the Legato is considered. If you play a wider interval, the note is considered Staccato. This is typical of some acoustic instruments, where legato is only possible within a small interval, but not on wider ones.

As an example, please try the Sound "Nylon Guitar DNC", where the Max Range is 5 semitones. Play legato with intervals smaller than 5 semitones, and you will hear how smoother legato notes will become. Play legato with wider intervals, and legato smoothing will be lost.

- 1...127 st Max range in semitones.

Basic: OSC Basic

The multisample(s) on which the Sound will be based can be selected here for each of the sixteen oscillators. Each oscillator can use 1 or 2 multisamples, each one assigned to the High or Low layer.

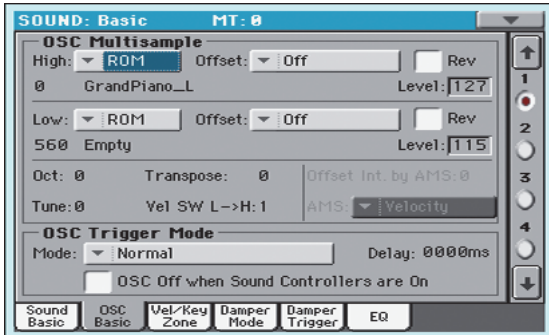

OSC Multisample

High/Low Bank/Num

Use these parameters to select a different multisample for each of the High and Low layers. You can use velocity to switch between the two multisamples. Offset and Level can be adjusted independently for the High and Low multisamples.

The High and Low pop-up menus is where you select the bank (ROM or RAM), while the numeric field under it is for selecting the multisample inside the selected bank. The Sound name appears on its right.

The multisample you select for the High layer will be triggered by velocities higher than the value of the “Velocity Multisample Switch Low-High” parameter (see page 206). If you do not wish to use velocity switching, set the switch to a value of 001, and select only the High multisample.

ROM The Factory bank. The Factory area of the internal memory contains 834 different multisamples (preset multisamples), supplied by Korg as standard.

RAM RAM multisample, read from the RAM. These are user-loaded multisamples.

Note: If you create a new Sound based on a RAM multisample, the RAM samples must be loaded from the internal memory or from a connected USB pen driver.

In case samples are not loaded, no sound will be heard, even if the Sound can be selected and its name appears in the display.

Note: Each multisample has an upper note range limit, and cannot produce sound when played above that limit.

Offset

These parameters specify the point where the multisample(s) will begin to play. For some multisamples this parameter will not be available.

Off The sound will start from the beginning of the multisample waveform.

1st...6th The sound will begin from the offset location predetermined for each sample.

No Attack The initial portion of the multisample is ignored.

AMS Activates the Alternate Modulation Source (see below).

PseudoRandom

(Only works when more than one Offset point is available in the multisample). Randomly selects one of the available Offset points (including Attack and Off).

Level

These parameters specify the level of each multisample.

0...127 Multisample level.

Note: Depending on the multisample, high settings of this parameter may cause the sound to distort when a chord is played. If this occurs, lower the level.

Octave

Use this parameter to adjust the pitch of the selected oscillator in octave units. The normal octave of the multisample is “0”.

-2...+1 Octave transposition.

Transpose

Use this parameter to adjust the pitch of the selected oscillator in semitone steps over a range of ± 1 octave.

-12...+12 Transposition in semitones.

Tune

Use this parameter to adjust the pitch of the sample in one-cent steps (a semitone is 100 cents) over a range of ± 1 octave.

-1200...+1200

Fine-tune value in cents.

Velocity Multisample Switch Low-High

This is the velocity value dividing the High and Low layers for the selected oscillator. Notes struck harder than this value will be played by the High multisample.

AMS / Offset Intensity by AMS

(Only available when the AMS option is selected in the “Offset” parameter.) Alternate Modulation Source for the Offset. See “AMS (Alternate Modulation Source) list” on page 229.

When the “Offset Intensity by AMS” parameter has a positive value, the selected Offset point will depend on the AMS value. For example, if the selected AMS is the Velocity, when playing softly you will select the Off or 1st Offset, when playing loudly you will select the 6th or No Attack Offset.

When the “Offset Intensity by AMS” parameter has a negative value, the selection will happen in reverse (higher-numbered Offsets will be selected before the lowest-numbered ones).

OSC Trigger Mode

OSC Trigger parameters are used to set the condition to trigger the selected Oscillator. For example, a Normal Oscillator will

always play, while a Legato Oscillator will only play when a note is played Legato.

Mode

This is the trigger that allows the selected Oscillator to play.

- Normal The Oscillator always plays when a key is pressed (unless the “OSC Off when Sound Controllers are On” parameter is checked).
- Legato The Oscillator only plays when the note is played ‘legato’. The delay and pitch interval from the previous note are also to be considered, as set in the Sound > Basic page (see “Legato as OSC Trigger” above).
- Staccato The Oscillator only plays when the note is NOT played legato (it is the opposite of the above choice).

Sound Controller 1

The Oscillator only plays after a switch or foot-switch programmed as the Sound Controller 1 has been pressed. Press and release it, and the next note will also trigger the selected Oscillator. If you keep it pressed, the Oscillator will continue to be triggered until you release the controller.

Note: In Sequencer and Sound mode, the Assignable Switch 1 is automatically assigned to Sound Controller 1.

Hint: This (like the following Sound Controllers) is especially useful to enable a different nuance to the following note(s).

Sound Controller 2

As the above, but with a switch or footswitch programmed as the Sound Controller 2.

Note: In Sequencer and Sound mode, the Assignable Switch 2 is automatically assigned to Sound Controller 2.

Sound Controller Y+

As the above, but with the Joystick, assigned as the Sound Controller, pushed at least half-way forward (value 64). The controller is turned off when the Joystick is released. This control is equivalent to a CC#01 (Modulation) Control Change message.

Sound Controller Y-

As the above, but with the Joystick, assigned as the Sound Controller, pulled at least half-way back (value 64). The controller is turned off when the Joystick is released. This control is equivalent to a CC#02 (Breath Controller) Control Change message.

- Cycle 1 All Oscillators with this same trigger mode assigned will play in cycle. For example, if Oscillators 1, 2 and 4 are assigned the Cycle 1 trigger mode, the following note will trigger Oscillator 1, then 2, then 4, then 1 again.

Hint: This is especially useful to trigger different sound nuances or create vector-like sound sequences.

- Cycle 2 As the above, for use with a different (and parallel) group of Oscillators. Having two Cycle Trigger Modes allows for cycling stereo multisamples.

- Random As the above, but with a random selection of Oscillators within the assigned group.

After Touch Trigger On

The Oscillator starts playing when an After Touch message with a value of at least 90 is received. The Velocity value is the same as the latest Note On message. The Oscillator will stop playing when the After Touch value falls back to zero.

Hint: This (like the following Triggers) is especially useful to trigger harmonics or growls when a note is already playing.

Y+ Trigger On

As the above, but with the Joystick, assigned as the Sound Controller, pushed at least half-way forward (value 64). The controller is turned off when the Joystick is released. This control is equivalent to a CC#01 (Modulation) Control Change message.

Y- Trigger On

As the above, but with the Joystick, assigned as the Sound Controller, pulled at least half-way back (value 64). The controller is turned off when the Joystick is released. This control is equivalent to a CC#02 (Breath Controller) Control Change message.

- Legato Up Like Legato, but is only activated when the second note is out of the “Max Range” value (see page 205) and it is higher than the first one.

- Legato Down Like Legato, but is only activated when the second note is out of the “Max Range” value (see page 205) and it is lower than the first one.

Delay

This parameter sets a delay time from the note-on to the real beginning of the sound. With a setting of KeyOff, the sound will begin when note-off occurs. This is useful to create sounds such as the “click” that is heard when a harpsichord note is released. In this case, set the “Sustain” parameter to 0 (see page 220).

- 0...5000ms Delay time in milliseconds.

- Key Off The sound will begin when the note is released. The note velocity is read from the Key On Velocity.

- Key Rel Key Release. The sound will begin when the note is released. The note velocity is read from the Key Off Velocity.

- Nat Rel Natural Release. The sound will begin when the note is released. The note starts from the current volume of the sound. If the sound’s volume is already at zero, this oscillator is not retriggered.

OSC Off when Sound Controllers are On

This ‘mirrors’ the way Sound Controllers work. With this parameter checked, the current Oscillator will not play when one of the

Sound Controllers (Sound Controller 1, Sound Controller 2, Sound Controller Y+, Sound Controller Y-) is activated. It should be applied to Oscillators with Normal, Legato, Staccato, Cycle 1, Cycle 2, Random, After Touch Trigger On, Y+ Trigger On, Y- Trigger On, Legato Up and Legato Down trigger modes, that can be turned off by using a switch, footswitch, or the Joystick, programmed as a Sound Controller.

Basic: Vel/Key Zone

Here you can set a note and velocity range “window” for the selected oscillator.

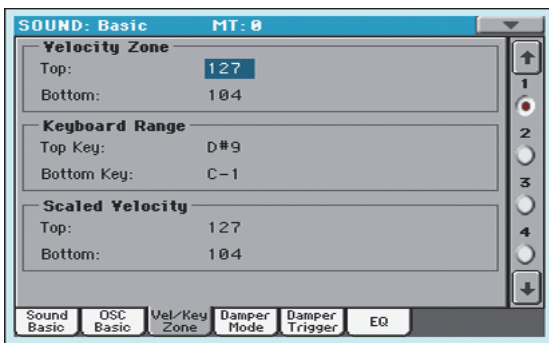

Velocity Zone

Here you can specify the velocity range for the selected oscillator.

Note: You cannot set the Bottom Velocity higher than the Top Velocity, nor the Top Velocity lower than the Bottom Velocity.

0...127 Assigned velocity.

Keyboard Range

Here you can specify the note range for the selected oscillator.

Note: You cannot set the Bottom Key higher than the Top key, nor the Top Key lower than the Bottom key.

C-1...G9 Assigned note.

Scaled Velocity

Use these parameters to scale velocity values received by the oscillator. By using the “Velocity Zone” function (see above), an oscillator may be limited to a restricted range (say, 10 to 20), that may result in weak dynamics when the associated sample is triggered.

By assigning a different value to these parameters, the restricted range will be converted to a wider range (for example, the lowest range value of 10 may be converted to a Scaled Velocity value of 0, and the highest range value of 20 may be converted to a Scaled Velocity value of 127). All values included between the minimum and maximum value are scaled accordingly.

As a consequence, you can create an RX Sound of guitar, by assigning the guitar fret noise to the 10~20 velocity range. When a dynamics value between 10~20 is received, the real velocity value is scaled to the Scaled Velocity values, and plays louder.

0...127 Assigned velocity value.

Basic: Damper Mode

Here you can program how the Damper pedal works, the Resonance/Halo effect, and the range within the Note Off message is not sent to the selected Oscillator:

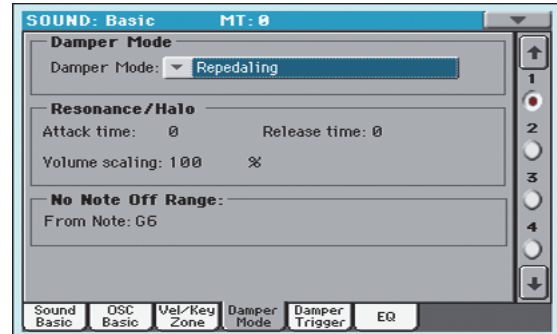

Damper Mode

Here you can program the Damper Mode for each Oscillator.

Damper Mode

This parameter determines how the Damper pedal works.

Normal The Damper pedal works as usual: by keeping it pressed, the note decay is lengthened, to simulate the longer note decay of an acoustic piano.

Damper Off The Damper pedal is deactivated for the selected Oscillator.

Hint: Set the Damper to Damper Off, if you plan to use the selected Oscillator in the Damper Trigger page to trigger sounds. Check the Sound “Harmonica DNC”, and see how the Damper Trigger is used.

Resonance/Halo

The Damper pedal enables a multisample, normally used for the Piano Resonance/Halo effect. If the pedal is pressed when the note is already playing, the speed at which the multisample appears and disappears, and the volume it can reach, depend on the “Resonance/Halo” parameters programmed below.

Hint: This Damper mode is much more realistic than the Normal mode, but also ‘steals’ more notes from the overall polyphony, and is especially suggested for solo piano playing.

Note: Half-pedaling, as well as Damper messages received via MIDI (as Control Change #64), control the level of the Resonance/Halo effect.

Repedaling This mode acts as the Normal mode, but also enables the Damper pedal effect when the pedal is pressed after the note has been released (Note Off). In this case, the Damper effect starts from the current Release level, and decays slowly.

Warning: Do not use Sounds with the “Repedaling” assigned to any Oscillator in a Style, or the sustained sound could cause unwanted dissonances. The “Grand Piano RX” Sound is an example of this kind of Sounds to be avoided in a Style track.

Resonance/Halo

Here you can program the Resonance/Halo effect that is enabled by the “Resonance/Halo” Damper Mode (see above). These parameters only affect the Resonance/Halo that is enabled when pressing the Damper pedal down when a note is already playing.

Attack Time

Time needed to the Resonance/Halo to reach the maximum level after the Damper pedal has been pressed.

0...99 Attack time as a value relative to the current Amp Env Attack value.

Release Time

Time needed to the Resonance/Halo to extinguish after the Damper pedal has been released.

0...99 Release time as a value relative to the current Amp Env Release value.

Volume Scaling

Volume of the Resonance/Halo effect, relative to the current level of the sound (as determined by the sum of the Multisample Volume, Velocity value and current Amp Env value).

0% No volume at all.

1...100% Volume expressed as a percentage of the current sound level.

No Note Off Range

From Note

Like in an acoustic piano, the dampers can only dampen strings up to a certain pitch. Starting from that pitch, it is as if the Damper was always pressed down.

Note: This parameter only affects the Normal Damper mode. It has no effect on the Resonance/Halo mode.

C#-1...G9 Note starting from which the Damper is always pressed down. In an acoustic piano, this is usually set to G6.

Basic: Damper Trigger

Here you can set the notes triggered by pressing and releasing the Damper Pedal. The parameters in this page have effect on the Sound as a whole, and not on a single Oscillator.

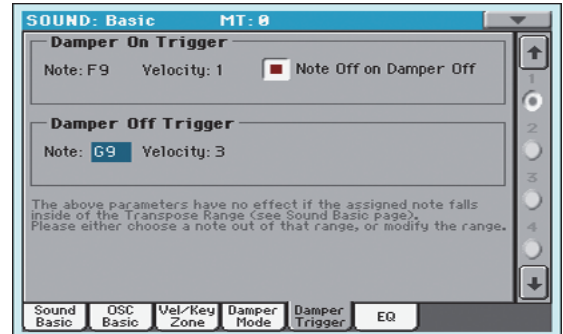

As warned by the message on the lower area of the display, these parameters have no effect if the assigned note falls inside of the Transpose Range programmed in the “Basic: Sound Basic” page (see “Transpose Range” on page 205). Please either choose a note out of that range, or modify the Transpose Range, so that the note is either higher or lower than that range.

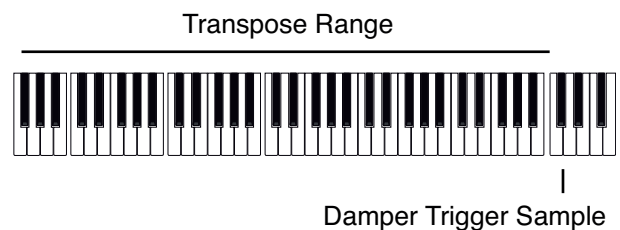

Damper On Trigger

Pressing down the Damper pedal (Damper On) can play a special sample assigned to a particular note (for example, pedal down squeaking in the Sound “Grand Piano RX”, breathing in in the Sound “Harmonica DNC” ...).

Note

Note where the special Damper On sample is located.

Velocity

Fixed velocity of the special Damper On sample.

Note Off on Damper Off

If checked, the special Damper On sample stops playing when the Damper pedal is released.

Damper Off Trigger

Releasing the Damper pedal (Damper Off) can play a special sample assigned to a particular note (for example, Damper pedal release noise in the Sound “Grand Piano RX”).

Note

Note where the special Damper Off sample is located.

Velocity

Fixed velocity of the special Damper Off sample.

Basic: EQ

In this page, you can set the semi-parametric three-band equalizer for the selected oscillator.

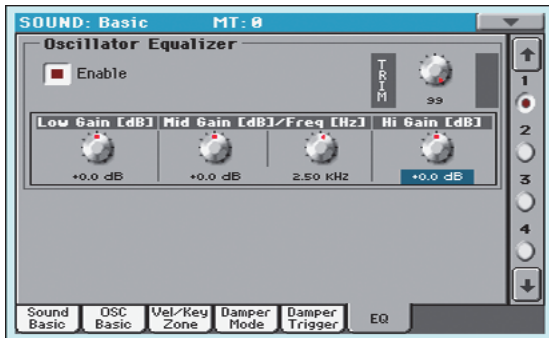

Enable

Check this box to activate the equalizer on the selected oscillator.

TRIM

This knob allows you to limit the level of the signal passing through the equalizer. Extreme equalization values can overload the audio circuits and lead to distortion. This control lets you set equalization as desired, and at the same time avoid overloading.

0...99 Limiting value. The higher, the most effective it is.

Low Gain

Low frequencies equalization. This is a shelving curve filter. Values are shown in decibels (dB).

-18...+18dB Low gain value in decibels.

Mid (Middle) Gain

Middle frequencies equalization. This is a bell curve filter. Values are shown in decibels (dB).

-18...+18dB Middle gain value in decibels.

Mid (Middle) Freq

Centre frequency of the middle frequencies equalization.

-0.100...+10 kHz

Centre frequency in kHz.

Hi (High) Gain

High frequencies equalization. This is a shelving curve filter. Values are shown in decibels (dB).

-18...+18dB High gain value in decibels.

DrumKit: Sample Setup (Drum Kits)

This page appears when you edit a Drum Kit. Here you can select a different percussive sample for each key and layer.

DRUM Drum Kits use only one oscillator.

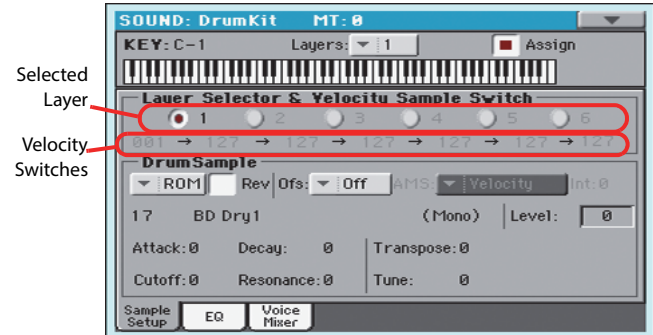

Key

Key

Key in edit. To select a key, you can press a key on the keyboard while this parameter is selected.

Layers

Number of layers assigned to the selected key. Depending on the number of selected layers, you can have a different number of velocity switches.

Assign

Use this parameter to turn the sample on/off.

On The sample is assigned to the selected key.

Off The sample is not assigned. The sample assigned to the next highest assigned key is used instead.

Layer Selector & Velocity Sample Switch

Selected Layer

Use these radio buttons to select the layer to edit. The available layers depends on the "Layers" parameter.

Velocity Switches

Each of these values separates the two adjacent layers for the selected sample/key. Notes stricken harder than a velocity switch will be played by the layer on the right, while notes stricken softer are played by the layer on the left.

The first and last values are not editable, and are always 001 and 127 (respectively).

Drum Sample

Bank/Num/Name

Use these parameters to select a different Drum Sample for each layer. You can use velocity to switch between the available samples. Offset and Level can be adjusted independently for the various drum samples.

The pop-up menu is where you select the bank (ROM or RAM), while the numeric field under it is for selecting the sample inside the selected bank. The sample name appears on its right.

The sample you select for the current layer will be triggered by velocities higher than the value of the “Velocity Switches” parameter (see page 210). If you do not wish to use velocity switching, assign just one layer to the selected key, and assign a sample only to Layer 1.

ROM The Factory bank. The internal Factory area of the Flash-ROM memory contains 1065 different samples (preset samples), supplied by Korg as standard.

RAM RAM sample, read from the RAM. These are user-loaded samples.

Note: If you create a new Drum Kit based on RAM samples, the RAM samples must be loaded from the internal memory or from a device connected to the USB Host port.

In case samples are not loaded, no sound will be heard, even if the Drum Kit can be selected and its name appears in the display.

Note: Each sample has an upper note range limit, and may not produce sound when played above that limit.

Rev (Reverse)

The sample will be played in reverse. In the case of Factory (Flash-ROM) or User (RAM) samples that were originally specified to loop, the sample will be played back in “one-shot” reverse mode. If the sample was originally set to reverse, it will playback without change.

- On The sample will playback in reverse.
- Off The sample will play back normally.

Ofs (Offset)

These parameters specify the point where the sample will begin to play. For some samples this parameter will not be available.

- Off The sound will start from the beginning of the sample.
- 1st...6th The sound will begin from the offset location pre-determined for each sample.
- NoAtk The initial portion of the multisample is ignored.
- AMS Activates the Alternate Modulation Source (see below).

PseudoRandom

(Only works when more than one Offset point is available in the multisample). Randomly selects one of the available Offset points (including Attack and Off).

AMS / Int(ensity)

(Only available when the AMS option is selected in the “Offset” parameter.) Alternate Modulation Source for the Offset. See “AMS (Alternate Modulation Source) list” on page 229.

When the “Intensity” parameter has a positive value, the selected Offset point will depend on the AMS value. For example, if the selected AMS is the Velocity, when playing softly you will select the Off or 1st Offset, when playing loudly you will select the 6th or No Attack Offset.

When the “Intensity” parameter has a negative value, the selection will happen in reverse (higher-numbered Offsets will be selected before the lowest-numbered ones).

Level

This parameter specifies the level of the sample. For more information, see “Level” on page 206.

Attack

This parameter is an offset to the selected sample’s EG Attack.

Decay

This parameter is an offset to the selected sample’s EG Decay.

Cutoff

This parameter sets the cutoff frequency for the filter applied to the selected sample.

Resonance

This parameter sets the resonance for the filter applied to the selected sample.

Transpose

This parameter transposes the selected sample. Use it to change the pitch of the selected key.

- 0 No transposition applied.
- 64...+63 Transpose value in semitones.

Tune

Use this parameter to fine-tune the assigned sample.

- 0 Original tuning.
- 99...+99 Fine-tuning value in cents (1/100 of a semitone).

DrumKit: EQ (Drum Kits)

This page appears when you edit a Drum Kit. In this page, you can set the semi-parametric three-band equalizer for the selected key, layer and Drum sample.

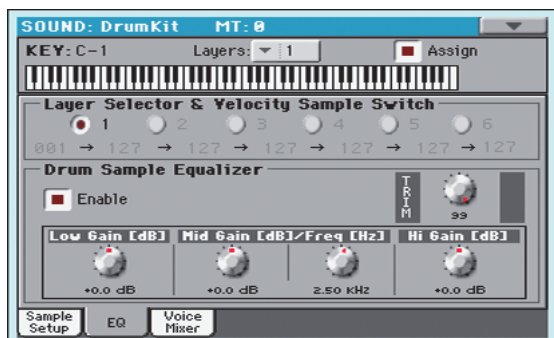

Key

See “Key” on page 210.

Layer Selector & Velocity Sample Switch

See “Layer Selector & Velocity Sample Switch” on page 210.

Drum Sample Equalizer

Enable

Check this box to activate the equalizer on the selected oscillator.

TRIM

This knob allows you to limit the level of the signal passing through the equalizer. Extreme equalization values can overload the audio circuits and lead to distortion. This control lets you set equalization as desired, and at the same time avoid overloading.

0...99 Limiting value. The higher, the most effective it is.

Low Gain

Low frequencies equalization. This is a shelving curve filter. Values are shown in decibels (dB).

-18...+18dB Low gain value in decibels.

Mid (Middle) Gain

Middle frequencies equalization. This is a bell curve filter. Values are shown in decibels (dB).

-18...+18dB Middle gain value in decibels.

Mid (Middle) Freq

Centre frequency of the middle frequencies equalization.

-0.100...+10 kHz

Centre frequency in kHz.

Hi (High) Gain

High frequencies equalization. This is a shelving curve filter. Values are shown in decibels (dB).

-18...+18dB High gain value in decibels.

DrumKit: Voice Mixer (Drum Kits)

This page appears when you edit a Drum Kit. Here you can set various parameters for the different percussive sample assigned to the selected key and layer.



Key

See “Key” on page 210.

Voice Assign Mode

Single Trigger

Use this parameter to set the sample as a single-triggered one.

On When the same key (note) is played repeatedly, the previous note will be stopped before the new note is triggered, so that they will not overlap.

Off When the same key (note) is played repeatedly, the previous note will not be stopped before the new note is triggered.

Exclusive Group

Exclusive Groups are sets of mutually exclusive keys, stopping each other. For example, if the Open Hi-Hat and Closed Hi-Hat are assigned the same Exclusive Group, playing an Open Hi-Hat will stop the Closed Hi-Hat playing.

None No Exclusive Group assigned. The selected key will not be stopped by any other key.

1...127 Exclusive Groups assigned to the selected key. When you play this key, all other keys assigned to the same Exclusive Group will be stopped, and this key will be stopped by other keys assigned to the same Exclusive Group.

Enable Note On Receive

Use this parameter to enable/disable the reception of the Note On (Key On) message.

On The Note On message is normally received.

Off The Note On message is not received. Therefore, the corresponding key is muted.

Enable Note Off Receive

Use this parameter to enable/disable the reception of the Note Off (Key Off) message.

On The sound will stop as soon as you release the key.

Off The sound will continue playing up to the end of the sample. The Note Off message is ignored.

Mixer

Pan

This parameter sets the position in the stereo panorama of the selected key.

Send to MFX1, MFX2

These parameters set the MFX1 or MFX2 send level for the selected key.

Pitch: Pitch Mod

Here you can make pitch settings for each oscillator. These settings specify how keyboard location will affect the pitch of each oscillator, and select the controllers that will affect the oscillator pitch and specify the depth of control. You can also specify the amount of pitch change produced by the Pitch EG and by LFO1 and LFO2, switch portamento on/off and specify how it will apply.

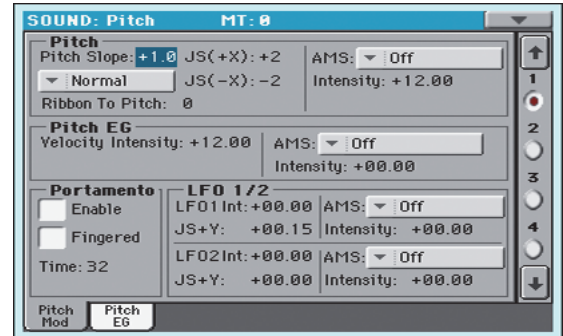

Pitch

Pitch Slope

Normally you will leave this parameter at +1.0. Positive (+) values will cause the pitch to rise as you play higher notes, and negative (-) values will cause the pitch to fall as you play higher notes.

With a value of 0, there will be no change in pitch, and the C4 pitch will sound regardless of the keyboard location you play.

The diagram shows how the Pitch Slope and pitch are related:

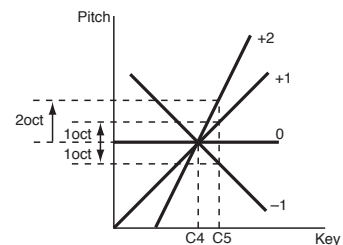

-1.0...+2.0 Pitch slope value.

Pitch Bend Mode

The Pitch Bend can work in different ways, depending on the selected option.

Normal Linear bending.

Fixed Scale When this parameter is turned on on an oscillator, Pitch Bend and Sub Scale have no effect on its tuning. The relevant parameters are greyed out and non-selectable. This is useful when assigning to the oscillator a noise (like the breath noise of a reed) with a fixed frequency, that must not change on different notes and different pitches.

Highest Pitch Bend only

On this oscillator, Pitch Bend is only activated on the highest note currently playing on the keyboard.

Lowest Pitch Bend only

On this oscillator, Pitch Bend is only activated on the lowest note currently playing on the keyboard.

Ribbon to Pitch

Pitch Bend range assigned to the Ribbon Controller message (CC#16). The Ribbon Controller message can be received from MIDI or contained in a Standard MIDI File.

-12...0...+12 Maximum bending, when touching the extreme left or right of the Ribbon Controller.

JS (+X)

This parameter specifies how the pitch will change when the joystick is moved all the way to the right. A setting of 12 produces 1 octave of change.

For example if you set this to +12 and move the joystick all the way to the right, the pitch will rise one octave above the original pitch.

-60...+12 Maximum pitch change in semitones.

JS (-X)

This parameter specifies how the pitch will change when the joystick is moved all the way to the left. A setting of 12 produces 1 octave of change.

For example, if you set this to -60 and move the joystick all the way to the left, the pitch will fall five octaves below the original pitch. This can be used to simulate the downward swoops that a guitarist produces using the tremolo arm.

-60...+12 Maximum pitch change in semitones.

AMS (Alternate Modulation Source)

This parameter selects the source that will modulate the pitch of the selected oscillator. See “AMS (Alternate Modulation Source) list” on page 229.

Intensity

This parameter specifies the depth and direction of the effect produced by “AMS”. With a setting of 0, no modulation will be applied. With a setting of 12.00, the pitch will change up to one octave.

For example, if you set “AMS” to After Touch and apply pressure to the keyboard, the pitch will rise if this parameter is set to a positive (+) value, or fall if this parameter is set to a negative (-) value. The range is a maximum of one octave.

-12.00...+12.00

Parameter value.

Pitch EG

The Pitch EG (Envelope Generator) is unique to all oscillators.

Velocity Intensity

This parameter specifies the depth and direction of the modulation that the pitch EG specified on “Pitch: Pitch EG” will apply to the pitch. With a setting of 12.00, the pitch will change a maximum of ±1 octave.

-12.00...+12.00

Parameter value.

Pitch EG AMS (Alternate Modulation Source)

This parameter selects the source that will modulate the pitch EG of the selected oscillator. See “AMS (Alternate Modulation Source) list” on page 229.

Pitch EG Intensity

This parameter specifies the depth and direction of the effect that “AMS” will have. For example, if you set “AMS” to Velocity and set this value to +12.00, the velocity will control the range of pitch change produced by the pitch EG in a range of ±1 octave. As you play more softly, the pitch change will draw closer to the pitch EG levels.

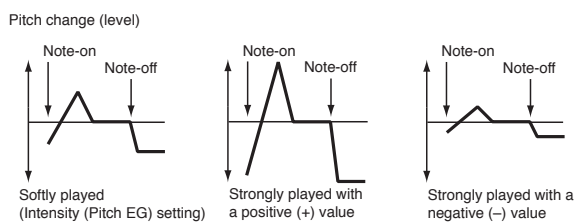

Note: “Intensity” (Pitch EG) and AMS will be added to determine the depth and direction of the pitch modulation applied by the pitch EG.

Portamento

Enabled

This parameter turns the portamento effect (smooth change in pitch from one note to the next) on/off, and specifies how it will be applied.

Note: Portamento will also be switched when CC#65 (Portamento SW) is received.

On Portamento will be applied.

Off Portamento will not be applied.

Fingered

This parameter specifies whether the portamento effect restarts or not with each note played.

On Portamento will restart with each note.

Off Portamento will not restart with each note.

Time

This parameter sets the portamento time. Increasing the value will produce a slower change in pitch.

000...127 Portamento time in MIDI value.

LFO 1/2

LFO1/2 Int

Intensity of the corresponding LFO.

-12...0...+12 Parameter value. Negative values invert the LFO shape.

JS+Y

Intensity of the corresponding LFO when the joystick is pushed forward.

-12...0...+12 Parameter value. Negative values invert the LFO shape.

AMS / Intensity

Alternate Modulation Source for the LFO. See “AMS (Alternate Modulation Source) list” on page 229. Use the “Intensity” parameter to set the intensity of the modulation.

Pitch: Pitch EG

Here you can make settings for the pitch EG, which creates time-variant changes in the pitch of the oscillators. The depth of pitch change produced by these EG settings on the oscillators is adjusted by the “Intensity (AMS1/2 Intensity)” parameter (see page 216).

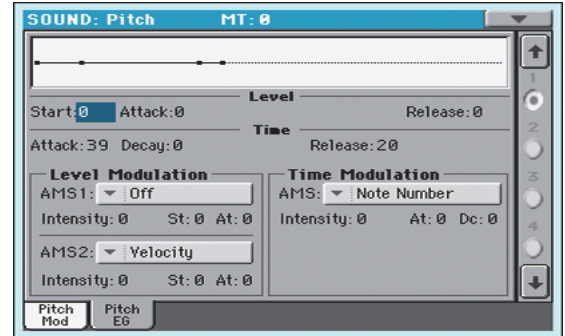

Diagram

The diagram on top of the page shows the Pitch envelope line.

Level

These parameters specify the amount of pitch change. The actual amount of pitch change will depend on the “Intensity (AMS1/2 Intensity)” parameter (see below). For example, with an “Intensity” setting of +12.00, a “Level” setting of +99 would raise the pitch one octave, and a “Level” setting of -99 would lower the pitch one octave.

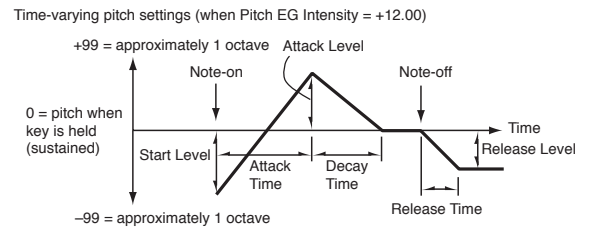

Start Level

Specifies the amount of pitch change at note-on.

-99...+99 Parameter value.

Attack Level

Specifies the amount of pitch change when the attack time has elapsed.

-99...+99 Parameter value.

Release Level

Specifies the amount of pitch change when the release time has elapsed.

-99...+99 Parameter value.

Time

These parameters specify the time over which the pitch change will occur.

See diagram above.

Attack Time

Specifies the time over which the pitch will change from note-on until it reaches the pitch specified as the attack level.

0...99 Parameter value.

Decay Time

Specifies the time over which the pitch will change after reaching the attack level until it reaches the normal pitch.

0...99 Parameter value.

Release Time

Specifies the time over which the pitch will change from note-off until it reaches the pitch specified as the release level.

0...99 Parameter value.

Level Modulation

Pitch EG change (level) (AMS=JS-Y/Velocity, Intensity= positive (+) value)

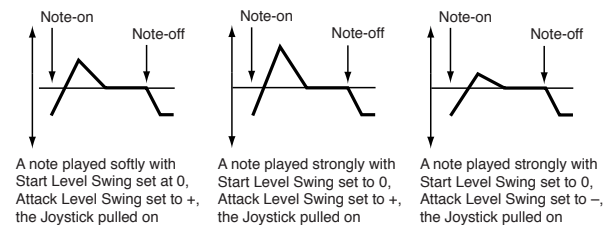

AMS1/2 (Alternate Modulation Source 1/2)

These parameters select the source that will control the pitch EG “Level” parameters (“AMS (Alternate Modulation Source) list” on page 229).

Intensity (AMS1/2 Intensity)

These parameters specify the depth and direction of the effect applied by “AMS1”. With a setting of 0, the levels specified by “Level” will be used.

For example, if “AMS1” is Joystick Y+, moving the Joystick in the upper direction to turn it on will change the “Level” parameters of the Pitch EG. As the absolute value of “Intensity” is increased, the pitch EG levels will change more when the Joystick is released. The direction of the change is specified by “St (Start Level Swing)” and “At (Attack Level Swing)”. When the Joystick is released, the pitch EG levels will return to their own settings.

If “AMS1” is set to Velocity, increasing the absolute value of “Intensity” will produce increasingly wider change in pitch EG levels for strongly-played notes. The direction of the change is specified by “St (Start Level Swing)” and “At (Attack Level Swing)”. As you play more softly, the pitch change will draw closer to the pitch EG levels.

-99...+99 Parameter value.

St (Start Level Swing)

This parameter specifies the direction of change in “Start Level” caused by “AMS1/2”. If “Intensity” is a positive (+) value, a setting of + will raise the EG level, and a setting of - will decrease it. With a setting of 0 there will be no change.

At (Attack Level Swing)

This parameter specifies the direction of change in “Attack Level” caused by “AMS1/2”. If “Intensity” is a positive (+) value, a setting of + will raise the EG level, and a setting of - will decrease it. With a setting of 0 there will be no change.

Time Modulation

Pitch EG changes (Time) (AMS = Velocity, Intensity = positive (+) value)

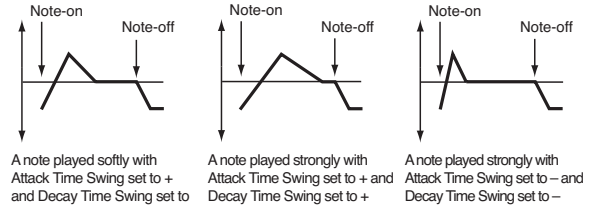

AMS (Alternate Modulation Source)

This parameter selects the source that will control the “Time” parameters of the pitch EG (see “AMS (Alternate Modulation Source) list” on page 229).

Intensity (AMS Intensity)

This parameter specifies the depth and direction of the effect that “AMS” will have on the “Time” parameters. With a setting of 0, the pitch EG times will be just as specified by the “Time” settings.

The alternate modulation value at the moment that the EG reaches each point will determine the actual value of the EG time that comes next.

For example, the decay time will be determined by the alternate modulation value at the moment that the attack level is reached.

When this parameter is set to values of 16, 33, 49, 66, 82, or 99, the specified EG times will speed up as much as 2, 4, 8, 16, 32, or 64 times respectively (or slowed down to 1/2, 1/4, 1/8, 1/16, 1/32, or 1/64 of the original time).

For example if “AMS” is set to Velocity, increasing the absolute value of “Intensity” will allow strongly-played notes to increase the changes in pitch EG “Time” values. The direction of the change is specified by “At (Attack Time Swing)” and “Dc (Decay Time Swing)”. As you play more softly, the pitch EG times will more closely approach the actual settings of the pitch EG.

-99...+99 Parameter value.

At (Attack Time Swing)

This parameter specifies the direction in which “AMS” will affect the “Attack Time” parameter. With positive (+) values of “Intensity”, a setting of + will cause the time to be lengthened, and a setting of - will cause the time to be shortened. With a setting of 0 there will be no change.

Dc (Decay Time Swing)

Specify the direction in which “AMS” will affect the “Decay Time”. With positive (+) values of “Intensity”, a setting of + will cause the time to be lengthened, and a setting of - will cause the time to be shortened. With a setting of 0 there will be no change.

Filter: Filter Type

Here you can make settings for the filters that will be used by the oscillators. You can select either a 24 dB/octave low pass filter with resonance, or a series connection of a 12 dB/octave low pass filter and a 12 dB/octave high pass filter.

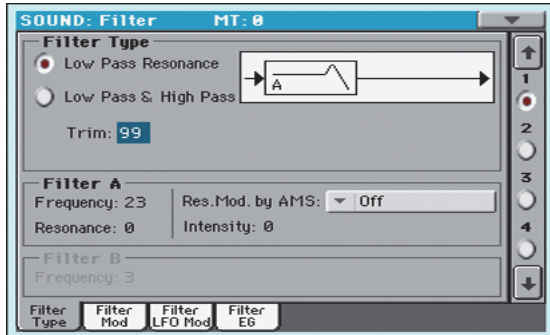

Filter Type

This parameter selects the type of filter (Low Pass Resonant, Low Pass & High Pass) for the selected oscillator.

Low Pass Resonance

When the Low Pass filter type is selected, only filter A will be activated.



Low Pass & High Pass

When the Low Pass & High Pass filter type is selected, the filter B will be activated.



Trim

Use this parameter to adjust the level at which the audio signal output from the selected oscillator is input to filter A.

Note: If this value is raised, the sound may distort if Resonance is set to a high value or when you play a chord.

00...99 Trim level.

Filter A

Frequency (Cutoff Frequency A)

This parameter specifies the cutoff frequency of filter A.

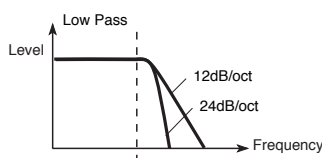

This is a filter that cuts the high-frequency region above the cutoff frequency. This is the most common type of filter, and is used to cut part of the overtone components, making an originally bright timbre sound more mellow (darker). When the "Filter Type" is Low Pass Resonance, the cutoff will have a steeper slope.

00...99 Cutoff frequency value.

Resonance (Resonance A)

The resonance emphasizes the overtone components that lie in the region of the cutoff frequency specified by "Frequency", producing a more distinctive sound. Increasing this value will produce a stronger effect.

00...99 Resonance value.

Res. Mod. by AMS (Resonance modulated by AMS)

Selects the source that will control the "Resonance" level. See "AMS (Alternate Modulation Source) list" on page 229.

The effect of resonance

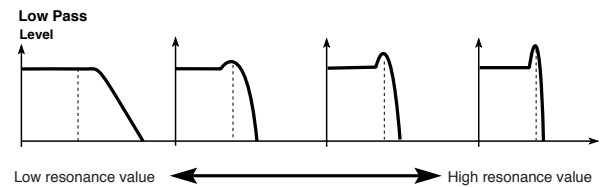

Intensity (AMS Intensity)

This parameter specifies the depth and direction of the effect that "Res. Mod. by AMS (Resonance modulated by AMS)" will have on the resonance level specified by "Resonance (Resonance A)".

For example if Velocity has been selected, changes in keyboard velocity will affect the resonance.

With positive (+) values, the resonance will increase as you play more strongly, and as you play more softly the resonance will approach the level specified by the "Resonance" setting.

With negative (-) values, the resonance will decrease as you play more strongly, and as you play more softly the resonance will approach the level specified by the "Resonance" setting.

The resonance level is determined by adding the "Resonance" and "Intensity (AMS Intensity)" values.

-99...+99 Parameter value.

Filter B

Frequency (Cutoff Frequency B)

This parameter specifies the cutoff frequency of filter B. This parameter will be displayed when "Filter Type" is set to Low Pass & High Pass.

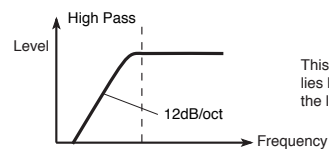

This filter cuts the low-frequency range that lies below the cutoff frequency. By cutting the lower overtones, it lightens the tone.

00...99 Cutoff frequency value.

Filter: Filter Mod

These settings let you apply modulation to the cutoff frequency (“Frequency”) of the filter for the selected oscillator to modify the tone.

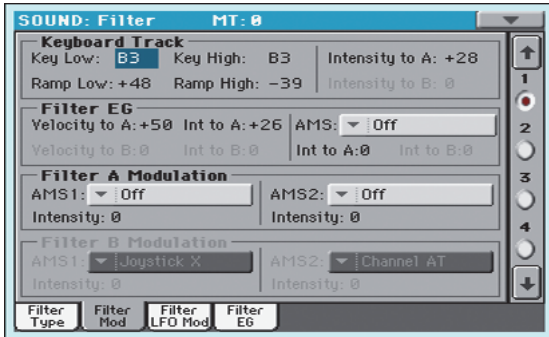

When “Filter Type” is Low Pass Resonance, parameters for filter B will not be editable (greyed out).

Keyboard Tracking

Key Low/High

These settings specify keyboard tracking for the cutoff frequency of the filter for the selected oscillator. The way in which the cutoff frequency is affected by the keyboard location you play can be specified by the “Key Low”, “Key High”, “Ramp Low” and “Ramp High” parameters.

Keyboard tracking will apply to the range below the specified Low note number, and above the specified High note number.

C-1...G9 Lowest/Highest note in the range.

Ramp Low/High

These parameter specifies the angle of keyboard tracking.

If “Intensity to A” and “Intensity to B” are set to +50, “Ramp Low” is set to -62 and “Ramp High” is set to +62, the angle of the change in cutoff frequency will correspond to the keyboard location (pitch). This means that the oscillation that occurs when you increase the “Resonance (Resonance A)” will correspond to the keyboard location.

If you set “Ramp Low” to +43 and “Ramp High” to -43, the cutoff frequency will not be affected by keyboard location. Use this setting when you do not want the cutoff frequency to change for each note.

-99...+99 Angle value.

Here is how cutoff frequency is affected by keyboard location and the Ramp setting (“Intensity to A” and “Intensity to B” = +50):

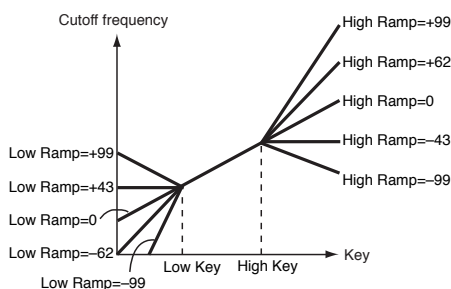

Tracking to A/B

These parameters specify the note numbers at which keyboard tracking will begin to apply, and set the “Intensity to A” and “Intensity to B” parameters to specify the depth and direction of the change applied to filters A and B.

For the range of notes between “Key Low” and “Key High”, the cutoff frequency will change according to the keyboard location (pitch).

-99...+99 Parameter value.

Filter EG

changes in cutoff frequency

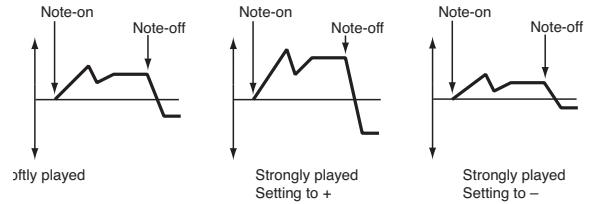

Velocity to A

This parameter specifies the depth and direction of the effect that velocity will have on the time-varying changes created by the filter EG (as set on “Filter: Filter EG”) to control the filter A cutoff frequency.

With positive (+) values, playing more strongly will cause the filter EG to produce greater changes in cutoff frequency. With negative (-) values, playing more strongly will also cause the filter EG to produce greater changes in cutoff frequency, but with the polarity of the EG inverted.

99...+99 Value of the Velocity to A parameter.

Velocity to B

This parameter specifies the depth and direction of the effect that velocity will have on the time-varying changes created by the filter EG to control the filter B cutoff frequency (see “Velocity to A”).

99...+99 Value of the Velocity to B parameter.

Int to A (Intensity to A)

Specifies the depth and direction of the effect that the time-varying changes created by the filter 1 EG will have on the filter A cutoff frequency.

With positive (+) settings, the sound will become brighter when the EG levels set by Filter EG “Level” and “Time” parameters are in the “+” area, and darker when they are in the “-” area.

With negative (-) settings, the sound will become darker when the EG levels set by Filter EG “Level” and “Time” parameters are in the “+” area, and brighter when they are in the “-” area.

-99...+99 Parameter value.

Int to B (Intensity to B)

Specifies the depth and direction of the effect that the time-varying changes created by the filter EG will have on the filter B cutoff frequency (see “Int to A (Intensity to A)”).

-99...+99 Parameter value.

AMS (EG Alternate Modulation Source)

Selects the source that will control the depth and direction of the effect that the time-varying changes produced by the filter EG will have on the cutoff frequency of filters A and B. See “AMS (Alternate Modulation Source) list” on page 229.

Int to A (Intensity to A)

Specifies the depth and direction of the effect that “AMS” will have on filter A. For details on how this will apply, refer to “Int to A (Intensity to A)”.

Int to B (Intensity to B)

Specifies the depth and direction of the effect that “AMS” will have on filter B. For details on how this will apply, refer to “Int to A (Intensity to A)”.

Note: The sum of the settings for “Velocity to A/B”, “Intensity to A/B”, and “(AMS) Intensity to A/B” will determine the depth and direction of the effect produced by the filter EG.

Filter A/B Modulation

AMS1 (Alternate Modulation Source 1 for filter A/B)

Selects the source that will control modulation of the filter A cutoff frequency. See “AMS (Alternate Modulation Source) list” on page 229.

Note: The filter B parameters will be displayed when “Filter Type” on page 217 is Low Pass & High Pass.

Intensity (Intensity to AMS1)

Specifies the depth and direction of the effect that “AMS1” will have.

When “AMS1” is JS X, a positive (+) value for this parameter will cause the cutoff frequency to rise when the joystick is moved toward the right, and fall when the joystick is moved toward the left. With a negative (–) value for this parameter, the opposite will occur.

This value is added to the setting of the Filter A “Frequency”.

AMS2 (Alternate Modulation Source 2 for filter A/B)

Selects the source that will control modulation of the filter A cutoff frequency (see “AMS (Alternate Modulation Source) list” on page 229).

Intensity (Intensity to AMS2)

Specifies the depth and direction of the effect that the selected source will have (see “Intensity (Intensity to AMS1)” on page 219).

Filter: Filter LFO

Here you can use the filter LFO to apply cyclic modulation to the cutoff frequency of the filter (for the selected oscillator) to create cyclical changes in tone.

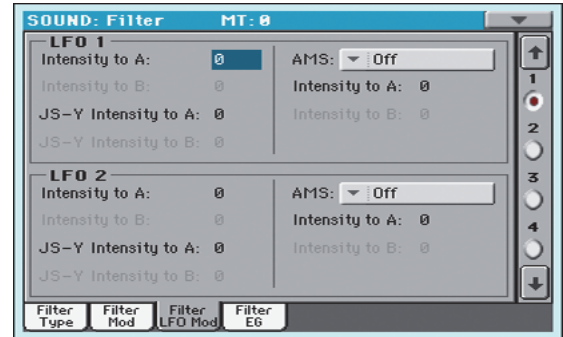

LFO 1

Intensity to A

Specifies the depth and direction of the modulation that LFO1 (set on “LFO: LFO1”) will have on the cutoff frequency of filter A. Negative (–) settings will invert the phase.

Change in cutoff

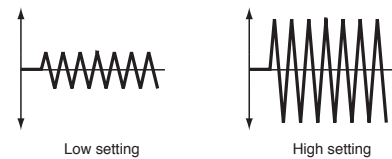

-99...+99 Parameter value.

Intensity to B

Specify the depth and direction of the modulation that LFO1 will have on the cutoff frequency of filter B (see “Intensity to A”).

-99...+99 Parameter value.

JS (Joystick) –Y Intensity to A

By moving the joystick in the Y direction (toward yourself), you can control the depth at which LFO1 modulates the cutoff frequency of filter A. This parameter specifies the depth and direction of the control.

Higher settings of this parameter will produce greater increases in the effect of LFO1 on the filter when the joystick is moved toward yourself.

-99...+99 Parameter value.

JS (Joystick) –Y Intensity to B

By moving the joystick in the Y direction (toward yourself), you can control the depth at which LFO1 modulates the cutoff frequency of filter B. This parameter specifies the depth and direction of the control (see “JS (Joystick) –Y Intensity to A”).

AMS (Filter LFO1 Alternate Modulation Source)

Select a source that will control the depth and direction of cutoff frequency change for both filters A and B. See “AMS (Alternate Modulation Source) list”.

Intensity to A

Specifies the depth and direction of the effect that “AMS” will have on filter A.

For example if “AMS” is Joystick Y+, higher settings of this parameter will allow greater change to be applied to LFO1 when you move the Joystick up in the Y axis.

-99...+99 Parameter value.

Intensity to B

Specifies the depth and direction of the effect that “AMS” will have on filter B (see “Intensity to A”).

LFO 2

Adjusts the depth of the cyclic modulation applied by LFO2 (set on “LFO: LFO2”) to the cutoff frequency of filters A and B. For more information on the parameters see “LFO 1” above.

Filter: Filter EG

Here you can make settings for the EG that will produce time-varying changes in the cutoff frequency of filters A and B for the selected oscillator. The depth of the effect that these settings will have on the filter cutoff frequency is determined by the “Velocity” and “Intensity” parameters.

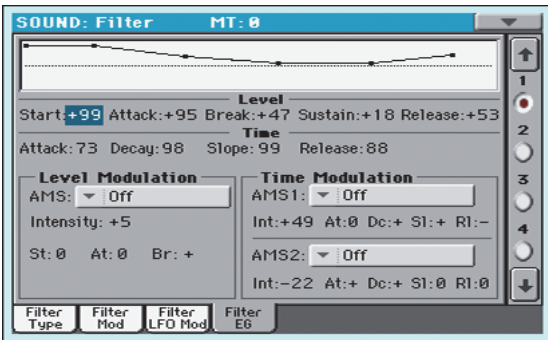

Diagram

The diagram on top of the page shows the Filter envelope line.

Filter envelope

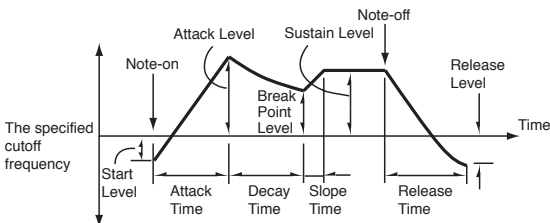

Level

These are the envelope segment levels. The result will depend on the filter that was selected in “Filter Type”. For example, with the Low Pass Resonance filter, positive (+) values of EG Intensity will cause the tone to be brightened by positive (+) levels, and darkened by negative (-) levels.

Start

This parameter specifies the change in cutoff frequency at the time of note-on.

-99...+99 Level value.

Attack

This parameter specifies the change in cutoff frequency after the attack time has elapsed.

-99...+99 Level value.

Break (Break Point)

This parameter specifies the change in cutoff frequency after the decay time has elapsed.

-99...+99 Level value.

Sustain

This parameter specifies the change in cutoff frequency that will be maintained from after the slope time has elapsed until note-off occurs.

-99...+99 Level value.

Release

This parameter specifies the change in cutoff frequency that will occur when the release time has elapsed.

-99...+99 Level value.

Time

These parameters specify the time over which the filter change will occur.

Attack

This parameter specifies the time over which the level will change from note-on until the attack level is reached.

0...99 Time value.

Decay

This parameter specifies the time over which the level will change from the attack level to the break point level.

0...99 Time value.

Slope

This parameter specifies the time over which the level will change after the decay time has elapsed until the sustain level is reached.

0...99 Time value.

Release

This parameter specifies the time over which the level will change after note-on occurs until the release level is reached.

0...99 Time value.

Level Modulation

Filter 1 EG changes (level) (AMS = Velocity, Intensity = a positive (+) value)

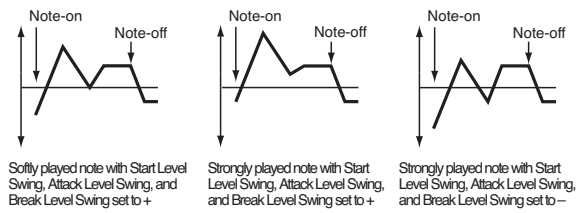

AMS (Alternate Modulation Source)

This parameter selects the source that will control the “Level” parameters of the filter EG (“AMS (Alternate Modulation Source) list” on page 229).

Intensity (AMS Intensity)

This parameter specifies the depth and direction of the effect applied by “AMS”. With a setting of 0, the levels specified by “Frequency (Cutoff Frequency A)” will be used.

For example, if “AMS” is Velocity, and you set “St (Start Level Swing)”, “At (Attack Level Swing)” and “Br (Break Level Swing)” to + and set “Intensity” to a positive (+) value, the EG levels will rise as you play more strongly. If “Intensity” is set to a negative (-) values, the EG levels will fall as you play more strongly.

-99...+99 Intensity value.

St (Start Level Swing)

This parameter specifies the direction in which “AMS” will affect “Start”. When “Intensity” has a positive (+) value, a setting of + for this parameter will allow “AMS” to raise the EG level, and a setting of - will allow “AMS” to lower the EG level. With a setting of 0 there will be no change.

At (Attack Level Swing)

This parameter specifies the direction in which “AMS” will affect “Attack”. When “Intensity” has a positive (+) value, a setting of + for this parameter will allow “AMS” to raise the EG level, and a setting of - will allow “AMS” to lower the EG level. With a setting of 0 there will be no change.

Br (Break Level Swing)

This parameter specifies the direction in which “AMS” will affect “Break (Break Point)”. When “Intensity” has a positive (+) value, a setting of + for this parameter will allow “AMS” to raise the EG level, and a setting of - will allow “AMS” to lower the EG level. With a setting of 0 there will be no change.

Time Modulation

Filter 1 EG changes (Time) (AMS = Velocity, Intensity = a positive (+) value)

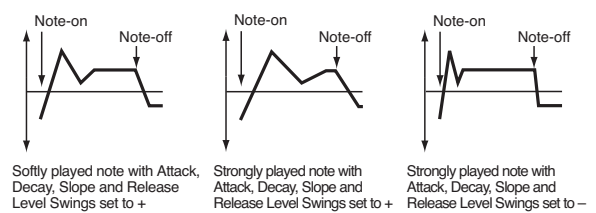

AMS1/2

Use this parameter to select the source that will control the “Time” parameters of the filter EG. See “AMS (Alternate Modulation Source) list” on page 229.

Int (AMS Intensity)

This parameter specifies the depth and direction of the effect that “AMS1/2” will have.

For example, if “AMS1/2” is set to FltKTr +/+, the EG “Time” parameters will be controlled by the Keyboard Tracking settings. With positive (+) values of this parameter, positive (+) values of “Ramp Low/High” will lengthen the EG times, and negative (-) values of “Ramp Low/High” will shorten the EG times. The direction of change is specified by “At (Attack Time Swing)”, “Dc (Decay Time Swing)”, “Sl (Slope Time Swing)”, and “Rl (Release Time Swing)”.

With a setting of 0, the times specified by “Frequency (Cutoff Frequency A)” will be used.

If “AMS1/2” is set to Velocity, positive (+) values of this parameter will cause EG times to lengthen as you play more strongly, and negative (-) values will cause EG times to shorten as you play more strongly.

-99...+99 Intensity value.

At (Attack Time Swing)

This parameter specifies the direction in which “AMS1/2” will affect the attack time. With positive (+) values of “Intensity”, setting this parameter to + will allow AMS to lengthen the time, and setting this parameter to - will allow AMS to shorten the time. With a setting of 0 there will be no change.

Dc (Decay Time Swing)

This parameter specifies the direction in which “AMS1/2” will affect the decay time. With positive (+) values of “Intensity”, setting this parameter to + will allow AMS to lengthen the time, and setting this parameter to - will allow AMS to shorten the time. With a setting of 0 there will be no change.

Sl (Slope Time Swing)

This parameter specifies the direction in which “AMS1/2” will affect the slope time. With positive (+) values of “Intensity”, setting this parameter to + will allow AMS to lengthen the time, and setting this parameter to - will allow AMS to shorten the time. With a setting of 0 there will be no change.

Rl (Release Time Swing)

This parameter specifies the direction in which “AMS1/2” will affect the release time. With positive (+) values of “Intensity”, setting this parameter to + will allow AMS to lengthen the time,

and setting this parameter to - will allow AMS to shorten the time. With a setting of 0 there will be no change.

Amp: Amp Level/Pan

These parameters control the volume and pan of the selected oscillator.

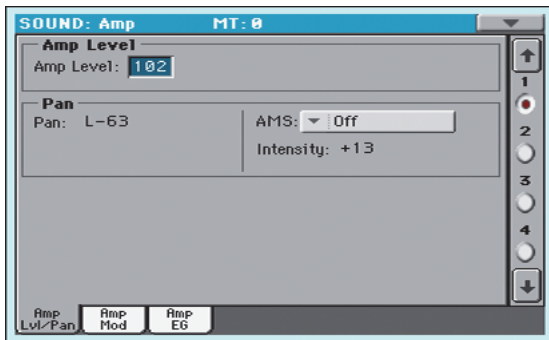

Amp Level

Volume of the selected oscillator.

Note: The volume of a Sound can be controlled by CC#7 (volume) and #11 (expression). The resulting level is determined by multiplying the values of CC#7 and #11. The Global MIDI channel is used for control.

0...127 Volume level.

Pan

Pan (stereo position) of the selected oscillator.

DRUM This parameter is not available when editing a Drum Kit. Use the individual Pan control for each key (see “Pan” on page 213).

- Random The sound will be heard from a different location at each note-on.
- L001 Places the sound at far left.
- C064 Places the sound in the center.
- R127 Places the sound to far right.

Note: This can be controlled by CC#10 (panpot). A CC#10 value of 0 or 1 will place the sound at the far left, a value of 64 will place the sound at the location specified by the “Pan” setting for each oscillator, and a value of 127 will place the sound at the far right. This is controlled on the global MIDI channel.

Pan modulation

AMS (Alternate Modulation Source)

Selects the source that will modify pan (see “AMS (Alternate Modulation Source) list” on page 229). This change will be relative to the “Pan” setting.

Intensity

Specifies the depth of the effect produced by “AMS”. For example, if “Pan” is set to C064 and “AMS” is Note Number, positive (+) values of this parameter will cause the sound to move toward the right as the note numbers increase beyond the C4 note (i.e.,

as you play higher), and toward the left as the note numbers decrease (i.e., as you play lower). Negative (-) values of this parameter will have the opposite effect.

-99...+99 Parameter value.

Amp: Amp Mod

These settings allow you to apply modulation to amp (for each oscillator) to modulate the volume.

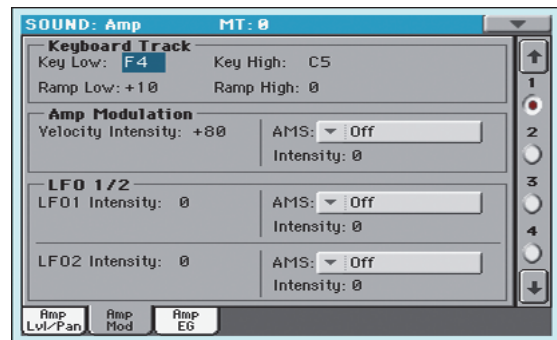

Keyboard Tracking

These parameters let you use keyboard tracking to adjust the volume of the selected oscillator. Use the “Key” and “Ramp” parameters to specify how the volume will be affected by the keyboard location that you play.

Key Low/High

These settings specify the note number at which keyboard tracking will begin to apply. The volume will not change between “Key Low” and “Key High”.

Keyboard tracking will apply to the range below the specified Low note number, and above the specified High note number.

C-1...G9 Lowest/Highest note in the range.

Ramp Low/High

These parameters specify the angle of keyboard tracking.

With positive (+) values of the “Ramp Low” parameter, the volume will increase as you play notes below the “Key Low” note number. With negative (-) values, the volume will decrease.

With positive (+) values of the “Ramp High” parameter, the volume will increase as you play notes above the “Key High” note number. With negative (-) values, the volume will decrease.

-99...+99 Angle value.

Here is an example of volume changes produced by keyboard location and “Ramp” settings:

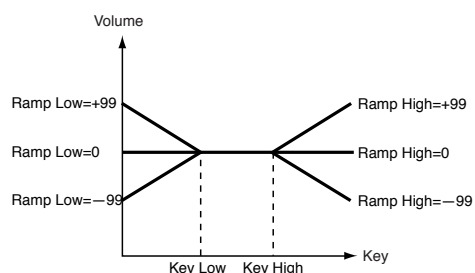

Amp Modulation

These parameters specify how the volume of the selected oscillator will be affected by velocity.

Velocity Intensity

With positive (+) values, the volume will increase as you play more strongly. With negative (-) values, the volume will decrease as you play more strongly.

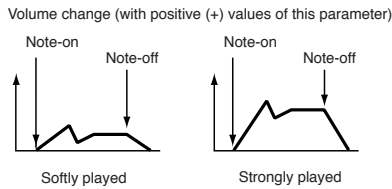

-99...+99 Intensity value.

AMS (Alternate Modulation Source)

Selects the source that will control the volume of the amp for the selected oscillator (See “AMS (Alternate Modulation Source) list” on page 229). “Velocity” cannot be selected.

Intensity

This parameter specifies the depth and direction of the effect that “AMS” will have. The actual volume will be determined by multiplying the value of the changes produced by the amp EG with the values of Alternate Modulation etc., and if the levels of the amp EG are low, the modulation applied by Alternate Modulation will also be less.

For example, if “AMS” is set to Joystick Y+, positive (+) values of this parameter will cause the volume to increase when you move the Joystick up in the Y axis. However if the EG settings etc. have already raised the volume to its maximum level, the volume cannot be increased further.

With negative (-) values of this parameter, the volume will decrease when pressure is applied to the keyboard.

-99...+99 Intensity value.

Amp: Amp EG

These parameters let you create time-varying changes in the volume of the selected oscillator.

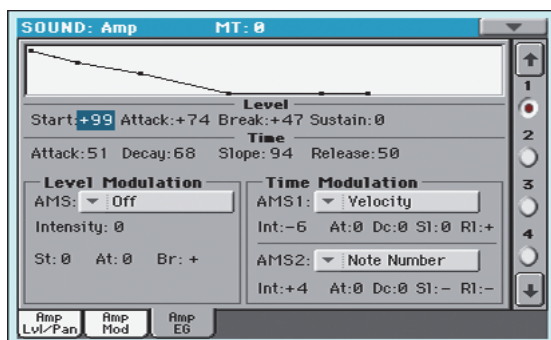

Diagram

The diagram on top of the page shows the Amplitude envelope line.

Level

These parameters are the level of the envelope segment.

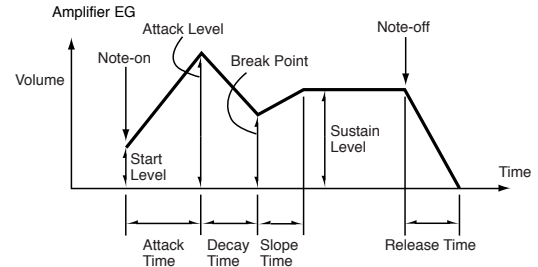

Start

This parameter specifies the volume level at note-on. If you want the note to begin at a loud level, set this to a high value.

0...99 Level value.

Attack

This parameter specifies the volume level that will be reached after the attack time has elapsed.

0...99 Level value.

Break

This parameter specifies the volume level that will be reached after the decay time has elapsed.

0...99 Level value.

Sustain

This parameter specifies the volume level that will be maintained from after the slope time has elapsed until note-off occurs.

0...99 Level value.

Time

These parameters specify the time over which the volume change will occur.

Attack

This parameter specifies the time over which the volume will change after note-on until it reaches the attack level. If the start level is 0, this will be the rise time of the sound.

0...99 Time value.

Decay

This parameter specifies the time over which the volume will change from when it reaches the attack level until it reaches the break point level.

0...99 Time value.

Slope

This parameter specifies the time over which the volume will change from when it reaches the break point level until it reaches the sustain level.

0...99 Time value.

Release

This parameter specifies the time over which the volume will change after note-off until it reaches 0.

0...99 Time value.

Level Modulation

Amp 1 EG changes (Level) (AMS=Velocity, Intensity = a positive (+) value)

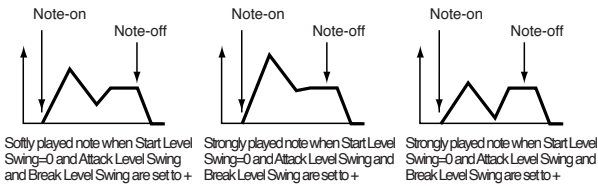

AMS (Alternate Modulation Source)

This parameter specifies the source that will control the “Level” parameters of the amp EG. See “AMS (Alternate Modulation Source) list” on page 229.

Intensity

This parameter specifies the depth and direction of the effect that “AMS” will have. For example, if “AMS” is Velocity, setting “St (Start Level Swing)”, “At (Attack Level Swing)” and “Br (Break Point Level Swing)” to + and setting “Intensity” to a positive (+) value will cause the amp EG volume levels to increase as you play more strongly. Setting “Intensity” to a negative (-) values will cause the amp EG volume levels to decrease as you play more strongly. With a setting of 0, the levels will be as specified on “Amp: Amp EG”.

-99...+99 Intensity value.

St (Start Level Swing)

This parameter specifies the direction in which “AMS” will change “Start”. If “Intensity” is set to a positive (+) value, setting this parameter to + will allow AMS to increase the EG level, and setting this parameter to - will allow AMS to decrease the EG level. With a setting of 0, no change will occur.

At (Attack Level Swing)

This parameter specifies the direction in which “AMS” will change “Attack”. If “Intensity” is set to a positive (+) value, setting this parameter to + will allow AMS to increase the EG level, and setting this parameter to - will allow AMS to decrease the EG level. With a setting of 0, no change will occur.

Br (Break Point Level Swing)

This parameter specifies the direction in which “AMS” will change “Break”. If “Intensity” is set to a positive (+) value, setting this parameter to + will allow AMS to increase the EG level, and setting this parameter to - will allow AMS to decrease the EG level. With a setting of 0, no change will occur.

Time Modulation

These parameters let you use an alternate modulation source to modify the amp EG times that were specified in “Time” on page 223.

Amp 1 EG changes (Time)

(AMS=Amp KTrk +/+, Intensity = a positive (+) value)
(When Amp Keyboard Track “Low Ramp” = a positive (+) value, and “High Ramp” = a positive (+) value)

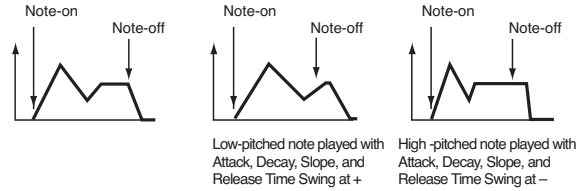

Amp 1 EG changes (Time) (AMS=Velocity, Intensity= a positive (+) value)

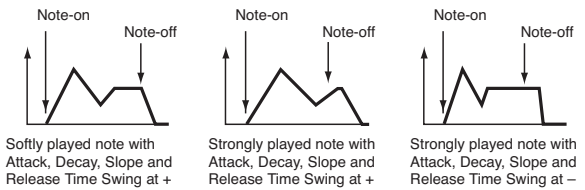

AMS1 (Alternate Modulation Source 1 - Time)

This parameter specifies the source that will control the “Time” parameters of the amp EG (see “AMS (Alternate Modulation Source) list” on page 229). With a setting of Off, there will be no modulation.

Intensity

This parameter specifies the depth and direction of the effect that “AMS1” will have. For example, if “AMS1(T)” is Amp KTrk +/+, the (Amp) Keyboard Track settings (see “Keyboard Tracking” on page 222) will control the EG “Time” parameters. With positive (+) values of this parameter, positive (+) values of “Ramp (Ramp Setting)” will cause EG times to be lengthened, and negative (-) values of “Ramp (Ramp Setting)” will cause EG times to be shortened. The direction of the change is specified by “At (Attack Time Swing)”, “Dc (Decay Time Swing)”, “Sl (Slope Time Swing)”, and “Rl (Release Time)”.

When “AMS1(T)” is Velocity, positive (+) values will cause EG times to lengthen as you play more strongly, and negative (-) values will cause EG times to shorten as you play more strongly. With a setting of 0, the EG times will be as specified by the “Level” parameters (see page 223).

At (Attack Time Swing)

This parameter specifies the direction of the effect that “AMS1” will have on “Attack”. With positive (+) values of “Intensity”, setting this parameter to + will allow AMS1 to lengthen the time, and setting it to - will allow AMS1 to shorten the time. With a setting of 0 there will be no effect.

Dc (Decay Time Swing)

This parameter specifies the direction of the effect that “AMS1” will have on “Decay”. With positive (+) values of “Intensity”, setting this parameter to + will allow AMS1 to lengthen the time, and setting it to - will allow AMS1 to shorten the time. With a setting of 0 there will be no effect.

SI (Slope Time Swing)

This parameter specifies the direction of the effect that “AMS1” will have on “Slope”. With positive (+) values of “Intensity”, setting this parameter to + will allow AMS1 to lengthen the time, and setting it to - will allow AMS1 to shorten the time. With a setting of 0 there will be no effect.

RI (Release Time)

This parameter specifies the direction of the effect that “AMS1” will have on “Release”. With positive (+) values of “Intensity”, setting this parameter to + will allow AMS1 to lengthen the time, and setting it to - will allow AMS1 to shorten the time. With a setting of 0 there will be no effect.

AMS2 (Alternate Modulation Source 2)

This is another alternate modulation source for the Amp EG. See above “AMS1” parameters.

LFO: LFO1

In this and the next page you can make settings for the LFO that can be used to cyclically modulate the Pitch, Filter, and Amp of each oscillator. There are two LFO units for each oscillator. By setting the LFO1 or LFO2 Intensity to a negative (-) value for Pitch, Filter, or Amp, you can invert the LFO waveform.

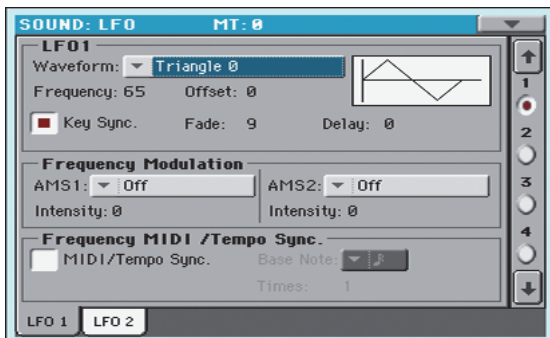

Waveform

This parameter selects the LFO waveform. The numbers that appear at the right of some of the LFO waveforms indicate the phase at which the waveform will begin.

Triangle 0		Step Triangle - 4	
Triangle 90		Step Triangle - 6	
Triangle Random		Step Saw - 4	
Saw 0		Step Saw - 6	
Saw 180			
Square			
Sine			
Guitar			
Exponential Triangle			
Exponential Saw Down			
Exponential Saw Up			

Phase will change randomly at each key-in

Sawtooth down 0

Square wave

Sine wave

Guitar vibrato

Random1 (S/H): Conventional sample & hold (S/H) in which the level changes randomly at fixed intervals of time

Random2 (S/H): Both the levels and the time intervals will change randomly.

Random3 (S/H): The maximum level and minimum level will alternate at random intervals of time (i.e., a square wave with random period).

Random4 (Vector)

Random5 (Vector)

Random6 (Vector)

These types cause Random 1-3 to change smoothly. They can be used to simulate the instability of acoustic instruments etc.

Frequency

Set the LFO frequency. A setting of 99 is the fastest.

00...99 Frequency rate.

Offset

This parameter specifies the central value of the LFO waveform. For example, with a setting of 0 as shown in the following diagram, the vibrato that is applied will be centered on the note-on pitch. With a setting of +99, the vibrato will only raise the pitch above the note-on pitch, in the way in which vibrato is applied on a guitar.

When “Waveform” is set to Guitar, the modulation will occur only in the positive (+) direction even if you set “Offset” to 0.

Here are offset settings and pitch change produced by vibrato:

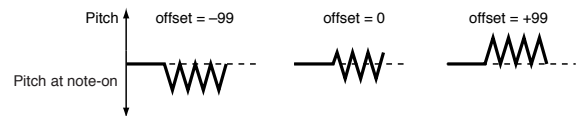

-99...+99 Offset value.

Key Sync

This parameter specifies if the LFO is synchronized to key strokes.

On The LFO will start each time you play a note, and an independent LFO will operate for each note.

Off The LFO effect that was started by the first-played note will continue to be applied to each newly-played note. (In this case, Delay and Fade will be applied only to the LFO when it is first started).

Fade

This parameter specifies the time from when the LFO begins to apply until it reaches the maximum amplitude. When “Key Sync.” is Off, the fade will apply only when the LFO is first started.

Here is how “Fade” affects the LFO (when “Key Sync” is On):

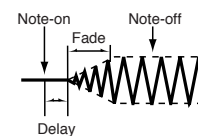

00...99 Fade rate.

Delay

This parameter specifies the time from note-on until the LFO effect begins to apply. When “Key Sync” is Off, the delay will apply only when the LFO is first started.

0...99 Delay time.

Frequency Modulation

You can use two alternate modulation sources to adjust the speed of the LFO1 for the selected oscillator.

AMS1 (Alternate Modulation Source1)

Selects the source that will adjust the frequency of the selected oscillator LFO1 (see “AMS (Alternate Modulation Source) list” on page 229). LFO1 can be modulated by LFO2.

Intensity (AMS1 Intensity)

This parameter specifies the depth and direction of the effect that “AMS1(F)” will have. When this parameter is set to a value of 16, 33, 49, 66, 82, or 99, the LFO frequency being can be increased by a maximum of 2, 4, 8, 16, 32, or 64 times respectively (or decreased by 1/2, 1/4, 1/8, 1/16, 1/32, or 1/64 respectively).

For example, if “AMS1(F)” is Note Number, positive (+) values of this parameter will cause the oscillator LFO to speed up as you play higher notes. Negative (–) values will cause the oscillator LFO to slow down as you play higher notes. This change will be centered on the C4 note.

If “AMS1(F)” is set to JS +Y, raising the value of this parameter will cause the oscillator LFO1 speed to increase as the joystick is moved away from yourself. With a setting of +99, moving the joystick all the way away from yourself will increase the LFO speed by approximately 64 times.

-99...+99 Intensity value.

AMS2 (Alternate Modulation Source2)

Intensity (AMS2 Intensity)

Make settings for a second alternate modulation source that will adjust the frequency of the oscillator LFO1 (see above “AMS1 (Alternate Modulation Source1)” and “Intensity (AMS1 Intensity)”).

Frequency MIDI/Tempo Sync

MIDI/Tempo Sync

This parameter enables/disables the LFO synchronization with Sequencer 1 Tempo.

On The LFO frequency will synchronize to the tempo (MIDI Clock) of Sequencer 1. In this case, the values you specified for “Frequency” (see page 225) and “Frequency Modulation” (see page 225) will be ignored.

Base Note

When “MIDI/Tempo Sync” is On, these parameters set a note length relative to “q (Tempo)” and the multiple (“Times”) that will be applied to it. These parameters will determine the frequency of the LFO1. For example if “Base Note” is q (quarter note) and “Times” is 04, the LFO will perform one cycle every four beats.

Even if you change the “q (Tempo)” setting of Sequencer 1, the LFO will always perform one cycle every four beats.

DRUM This parameter is not available when editing a Drum Kit.

Note Note value.

Times

DRUM This parameter is not available when editing a Drum Kit.

1...16 Beats before restarting the cycle.

LFO: LFO2

Here you can make settings for the LFO2, which is the second LFO that can be applied to the selected oscillator. See “LFO: LFO1” for more information on the parameters value.

However in “Frequency Modulation”, the LFO cannot be selected as a modulation source in “AMS1” or “AMS2.”

Effects: “B” FX Config

This page allows you to select the effects for the Sound (B Group). The effect types and the FX matrix are the same seen for the Style Play mode (see “Effects: A/B FX Configuration” on page 119 of the User’s Manual).

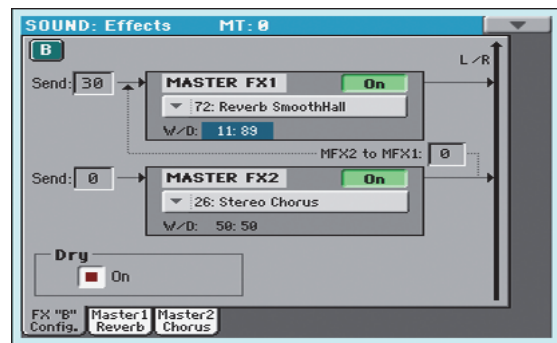

FX Name

Use this pop-up menu to choose one of the available effects. For a list of the available effects, see “Effects” on page 351.

FX parameters

All other parameters in this page are the same seen for the Style Play mode (see “Effects: A/B FX Configuration” on page 119 in the User’s Manual).

Send to Master

Use these parameters to set the level of the Sound signal going from the Insert FX to the Master FXs.

0...127 Level of the sent signal.

Dry

Use this checkbox to mix the dry, direct Sound signal to the effects.

Effects: Master 1 / Reverb

In this page you can edit the effect assigned to the Master FX 1 effect processor (usually Reverb). See “Effects” on page 357 for more information.

Effects: Master 2 / Chorus

In this page you can edit the effect assigned to the Master FX 2 effect processor (usually Chorus). See “Effects” on page 357 for more information.

Page menu

Touch the page menu icon to open the menu. Touch a command to select it. Touch anywhere in the display to close the menu without selecting a command.



Write Sound

Select this command to open the Write Sound dialog box, and save all editing parameters to a Sound.

See “Write Sound dialog box” on page 228 for more information.

Solo Oscillator

Select this command to solo the selected oscillator, and mute the other oscillators. Select it again to unmute the other oscillators.

When this function is activated, the “Solo OSC [n]” indicator (n = oscillator number) blinks on the page header. While in this situation, you can select a different oscillator to be soloed.

Swap LFO

Select this command to replace LFO1 with LFO2, and vice-versa.

Copy Oscillator

Select this command to copy all settings between oscillators. See “Copy Oscillator dialog box” on page 228 for more information.

Copy/Paste FX

Use this command to copy a single effect, or both effects of an FX group (A or B). See “Copy/Paste FX” on page 127 for detailed instructions.

Copy Drum Kit

Select this command to copy the Drum Kit from a different Drum Kit. See “Copy Drum Kit dialog box” on page 228 for more information.

Init Sound

Select this command to delete all parameters, and set them to a default value.

Compare

When this command is checked, original Sound parameter values are temporarily recalled, to compare them with edited parameters. You cannot edit the Sound while you are in Compare mode.

While this function is on, the Compare indicator blinks on the page header.

Write Sound dialog box

Open this window by selecting the Write Sound item from the page menu. Here, you can save all Sound parameters to a Sound location in memory.

Warning: If you write over an existing Sound, the Sound will be deleted and replaced by the one you are saving (“overwrite”). Please save on a storage device any User Sound you don’t want to lose.

Note: Drum Kits cannot be written over standard Sounds, nor vice versa.

Note: To save over a Factory Sound location, uncheck the “Factory Sound Protect” command in the Global > Mode Preferences > Media page (see page 254).

Warning: When replacing a Factory Sound, please be warned that all Performance, STSs, Styles and Songs making use of it will be modified as well. Use this feature with great care!

To restore the original data, please use the “Factory Restore” command in the Utility page of the Media mode (see page 291 for more information).



Name

Name of the Sound to be saved. Touch the **T** (Text Edit) button next to the name to open the Text Edit window.

Sound Bank

Target bank of Sounds. Use the VALUE controls to select a different bank.

Sound

Target Sound location in the selected bank. Use the VALUE controls to select a different location.

Select...

Touch this button to open the Sound Select window, and select a target location.

Copy Oscillator dialog box

Open this window by selecting the Copy Oscillator item from the page menu. Here, you can copy all settings between oscillators.

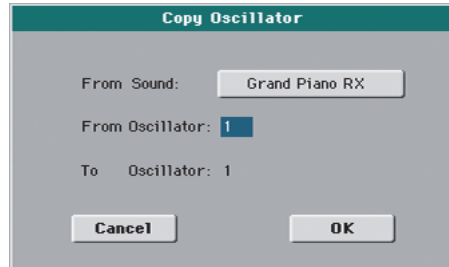

From Sound

Touch this button to open the Sound Select window, and select the source Sound.

From Oscillator

Select the source oscillator to copy from.

To Oscillator

Target oscillator where to copy the source settings to.

Copy Drum Kit dialog box

Open this window by selecting the Copy Drum Kit item from the page menu. Here, you can copy settings from a range of keys of a Drum Kit.

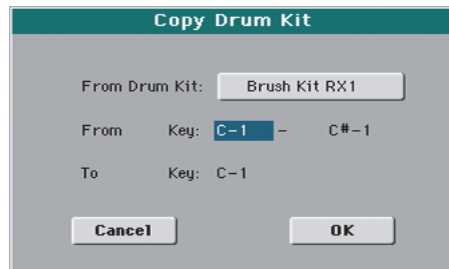

From Drum Kit

Touch this button to open the Sound Select window, and select the source Drum Kit.

From Key

Select the source range of keys to copy from.

To Key

Target key. Settings are copied starting from this key, and upwards.

AMS (Alternate Modulation Source) list

Off	Do not use Alternate Modulation
Pitch EG	Pitch EG
Filter EG	Filter EG within the same oscillator
Amp EG	Amp EG within the same oscillator
LFO1	LFO1 within the same oscillator
LFO2	LFO2 within the same oscillator
Flt KTrk +/+ (Filter Keyboard Track +/+)	Filter keyboard tracking within the same oscillator
Flt KTrk +/- (Filter Keyboard Track +/-)	Filter keyboard tracking within the same oscillator
Flt KTrk 0/+ (Filter Keyboard Track 0/+)	Filter keyboard tracking within the same oscillator
Flt KTrk +/0 (Filter Keyboard Track +/0)	Filter keyboard tracking within the same oscillator
Amp KTrk +/+ (Amp Keyboard Track +/+)	Amp keyboard tracking within the same oscillator
Amp KTrk +/- (Amp Keyboard Track +/-)	Amp keyboard tracking within the same oscillator
Amp KTrk 0/+ (Amp Keyboard Track 0/+)	Amp keyboard tracking within the same oscillator
Amp KTrk +/0 (Amp Keyboard Track +/0)	Amp keyboard tracking within the same oscillator
Note Number	Note number
Velocity	Velocity
Poly AT (Poly After Touch)	Polyphonic After Touch (received/transmitted via MIDI or contained in Standard MIDI Files)
Channel AT (Channel After Touch)	After Touch (Channel After Touch) (received/transmitted via MIDI or contained in Standard MIDI Files)
Joystick X	Joystick X (horizontal) axis
Joystick +Y	Joystick +Y (vertical upward) direction (CC#01)
Joystick Y	Joystick Y (vertical downward) direction (CC#02)
JS+Y & AT/2 (Joy Stick +Y & After Touch/2)	Joystick +Y (vertical upward) direction and After Touch (received/transmitted via MIDI or contained in Standard MIDI Files)
JS-Y & AT/2 (Joy Stick Y & After Touch/2)	Joystick Y (vertical downward) direction and After Touch (received/transmitted via MIDI or contained in Standard MIDI Files)
Assign. Pedal	Assignable foot pedal (CC#04)
Ribbon Ctl.	Ribbon controller (CC#16) (received/transmitted via MIDI or contained in Standard MIDI Files)
CC#18	CC#18
CC#17	CC#17
CC#19	CC#19
CC#20	CC#20
CC#21	CC#21
Damper	Damper pedal (CC#64)
CC#65	Portamento switch (CC#65)
Sostenuto	Sostenuto pedal (CC#66)
CC#80	CC#80
CC#81	CC#81
CC#82	CC#82
CC#83	CC#83
Tempo	Tempo (tempo data from Sequencer 1 clock or external MIDI clock)
Velocity Plus	Key On and Key Off Velocity are used
Velocity Exp	Velocity with Exponential curve (higher velocity notes are even louder)
Velocity Log	Velocity with Logarithmic curve (higher velocity notes are weaker than with the linear Velocity)

Flt KTrk +/+ (Filter Keyboard Track +/+)

Flt KTrk +/- (Filter Keyboard Track +/-)

Flt KTrk 0/+ (Filter Keyboard Track 0/+)

Flt KTrk +/0 (Filter Keyboard Track +/0)

Amp KTrk +/+ (Amp Keyboard Track +/+)

Amp KTrk +/- (Amp Keyboard Track +/-)

Amp KTrk 0/+ (Amp Keyboard Track 0/+)

Amp KTrk +/0 (Amp Keyboard Track +/0)

+/+ The direction of the effect will be determined by the sign (positive or negative) of the “Ramp Low” or “Ramp High” setting.

+/- The direction of the effect will be determined by the sign of the “Ramp Low” setting, and by the opposite sign of the “Ramp High” setting (50 for a setting of +50, and +50 for a setting of 50).

0/+ “Ramp Low” will have no AMS effect. The sign of the “Ramp High” setting will determine the direction of its effect.

+/0 The sign of the “Ramp Low” setting will determine the direction of its effect. “Ramp High” will have no AMS effect.

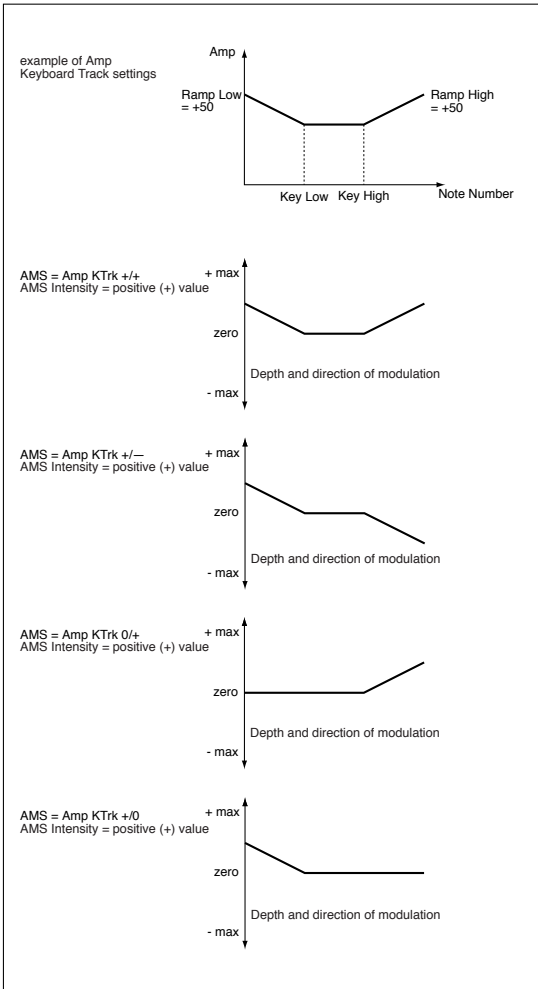

JS +Y & AT/2 (Joy Stick +Y & After Touch/2)

The effect will be controlled by the joystick +Y (vertically upward) and by after touch. In this case, the effect of after touch will be only half of the specified intensity.

JS Y & AT/2 (Joy Stick -Y & After Touch/2)

The effect will be controlled by the joystick Y (vertically downward) and by after touch. In this case, the effect of after touch will be only half of the specified intensity.

Sampling mode

The Sampling mode allows you to create new Samples, new Multisamples and new synced Audio Grooves. You can load Samples, Multisamples, Sounds and banks of Sounds from various formats.

Pa900 can read common file formats, like WAV, AIFF and SF2 files, and load data from Korg Trinity and Triton files.

To be used, Samples must be assigned to a Multisample or a Drum Kit. A Multisample allows you to arrange samples into separate zones of the keyboard. Drum Kits allows you to assign a different sample to each note of the keyboard, with up to six dynamic layers per note.

Multisamples can then be assigned to Sounds. Sounds created with this function can be used as any ordinary Sound, and assigned to any track.

Another powerful feature of the Sampling mode is the Time Slice, that lets you add realism to MIDI tracks by creating Audio Grooves.

Warning: When loading a “.SET” folder containing User PCM Samples, all existing User PCM Samples are deleted from memory. Save them before loading the folder, by selecting the “PCM” option during a Save All operation (see “Saving the full memory content” on page 285 of the User’s Manual).

To see if a “.SET” folder contains User PCM Samples, open it and look for a “PCM” folder.

Hint: If you want to load new User PCM Samples without deleting the ones already contained in memory, load single Sounds instead of a “.SET” folder.

Entering and exiting the Sampling mode

- While in Sound mode, press the RECORD button to enter in Sampling mode.
- While in Sampling mode, press the RECORD button to exit the Sampling mode, and return to the Sound mode.

Creating new Sounds from the Samples

Here is how to create a new Sounds from new Samples and Multisamples.

1. Create new Samples with the procedures described in the following pages.
2. Select the Write command from the page menu to save the Sample in edit. The Write Sample dialog box will appear (see “Write Sample dialog box” on page 243). Assign a name to the new Sample, and confirm saving.
3. After saving, you can load other files to create additional Samples.
4. When you have created and saved all the needed Samples, press the MENU button and go to the “Multisample” section, to assign the Sample(s) to a Multisample. Assign each Sample to a different keyboard zone of the Multisample.
5. When finished editing the Multisample, select the Write command from the page menu. The Write Multisample dialog box will appear (see “Write MultiSample dialog box” on page 243). Assign a name to the new Multisample, and save it to the internal memory.
6. Press RECORD to exit the Sampling mode and return to the Sound mode.
7. Select an ordinary Sound similar to the one you want to create.
8. Press MENU and go to the “Basic: OSC Basic” page (see page 206). Select one of the available layers, then select the RAM bank of Multisamples. Finally, select the new Multisample.
9. Select the Write Sound command from the page menu, and save the Sound to an empty User location.
10. If you want so, assign the new Sound to a track, then select the “Write Performance”, “Write Current Style Settings” or “Write STS” command from the page menu, to save the Sound to a Performance, Style Settings or STS.

Creating new Drum Kits from the Samples

Here is how to create a new Drum Kits from new Samples.

1. Create new Samples with the procedures described in the following pages.
2. Select the Write command from the page menu to save the Sample in edit. The Write Sample dialog box will appear (see “Write Sample dialog box” on page 243). Assign a name to the new Sample, and confirm saving.
3. After saving, you can load other files to create additional Samples.
4. When you have created and saved all the needed Samples, press RECORD to exit the Sampling mode and return to the Sound mode.
5. Select a Drum Kit similar to the one you want to create.
6. Press MENU and go to the “DrumKit: Sample Setup (Drum Kits)” page (see page 210). Select a key and a layer, then select the RAM bank of Samples. Finally, select the new Samples.
7. Select the Write Sound command from the page menu, and save the Drum Kit to an empty User DK location.
8. If you want so, assign the new Drum Kit to a track, then select the “Write Performance”, “Write Current Style Settings” or “Write STS” command from the page menu, to save the Drum Kit to a Performance, Style Settings or STS.

Hint: Drum Kits are better suited for the Drum or Percussion track. Assign them to the Style Settings.

Creating new Sounds from an Audio Groove

Creating an Audio Groove

After loading an Audio Groove, you must “slice” it to create a series of separate percussive Samples, a Multisample and a MIDI Groove.

1. Go to the Time Slice page. After creating a series of slices, use the Extend function to refine your groove.
2. Select the Write command from the page menu, to save the sliced Samples, a Multisample, a Sound and the MIDI Groove. Choose one of the User Sound locations. The Sound, Multisample, MIDI Groove and sliced Samples are saved to the internal memory.
3. Press RECORD to exit the Sampling mode and return to the Sound mode.

Assigning an Audio Grooves to a Sound

You can use the new Multisample and sliced Samples generated from the Audio Groove in a new User Sound.

1. To access the new Multisample for use in a Sound, go to the Sound mode.
2. Select an ordinary Sound. Press MENU and go to the “Basic: OSC Basic” page (see page 206). Select one of the available layers, then select the RAM bank of Multisamples. Finally, select the new Multisample.
3. Select the Write Sound command from the page menu, and save the Sound to an empty User location.

Assigning the Audio Groove to Styles or Pads

Sounds based on the Audio Groove can be used in Styles or Pads.

1. Assign the new Sound to a Style track (preferably, the Drum or Percussion track) or to a Pad track, then select the “Save Current Style Perf.” or “Write Pad” command from the page menu, to save the Style Settings or the Pad.
2. Use the “Import: Import Groove” function in the Style/Pad Record mode (see page 157) to import the generated MIDI Groove to the Style track you assigned the new Sound to. By playing this MIDI Groove with the new Sound, you’ll be able to play the original audio groove on the keyboard.

Warning: Generated MIDI Grooves will be deleted when turning the instrument off. Import them to a Style track before turning the instrument off.

Edit menu

From any page of the Sampling mode, press the MENU button to open the Sampling edit menu. This menu gives access to the various Sampling edit sections.

When in the menu, select an edit section, or press EXIT to exit the menu and return to the Sample Edit page. To return to this page, you can also select the Sample Edit menu item.

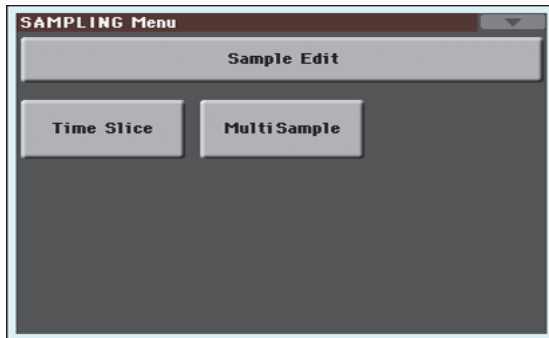

Each item in this menu corresponds to an edit section. Each edit section groups various edit pages, that may be selected by touching the corresponding tab on the lower part of the display.

Sampling: Edit

This page allows you to cut, trim or normalize a sample, as well as edit the loop points. The sample can be played on the full keyboard.

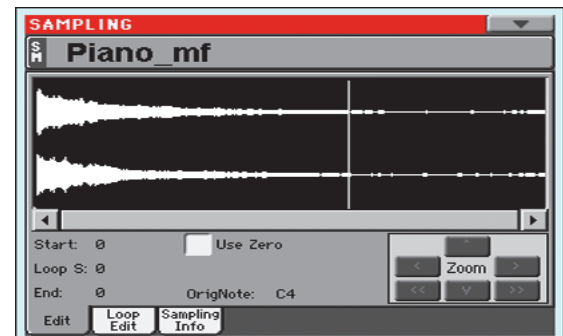

SM (Sample)

Selected sample.

Waveform display

This is the graphical display of the selected sample waveform, i.e., the one you can hear when playing the keyboard. The area included between the Start and End points is highlighted (dark background).

Parameters

Start (Sample Start)

This is the sample start point (in samples). You may edit this point, as well as the End point, to shorten the sample. Changing the Sample Start cuts out the attack portion of the sound.

Note: When moving the “Start” point forward, and reach the “Loop Start” point, this latter is also moved forward.

Warning: When saving the edited sample (Write Sample operation), the segments exceeding the Start and End points are permanently removed.

Loop Start

Note: This parameter has no effect, unless you don't turn the loop on. Use the “Loop On” parameter on the “Sampling: Loop Edit” page to turn the loop on (see page 235).

Use this parameter to adjust the Loop Start point. When you adjust this parameter, an audible click may appear, due to a pitch and/or level mismatch between the starting and ending points of the loop. Move the Loop Start and Loop/Sample End point, so that the click can no longer be heard.

When editing audio grooves, the Loop Start should match the Sample Start point. This parameter usually differs from the Sample Start in ordinary sounds (i.e., a guitar, a piano, a voice...).

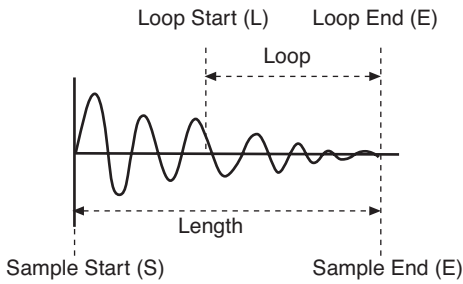

End (Sample/Loop End)

This is the sample and loop end point (in samples). You may edit this point, to shorten the sample.

Warning: When saving the edited sample (Write Sample operation), the segments exceeding the Start and End points are permanently removed.

Use Zero

If this parameter is turned on, when you move the Start, Loop Start and End points, the selection fall on the nearest zero-crossing point (i.e., points where the waveform crosses the x-axis, and goes from negative to positive, or from positive to negative values). This will make loops more accurate, and will reduce the risk of “clicks”.







OrigNote (Original Note)

Original pitch of the sampled note. While this parameter has no effect on sound, it will be useful to identify the original pitch of the sample and when assigning a sample to the multisample.

For example, if you sample a C4, set this parameter to “C4”. When the sample will be assigned to a keyboard zone of the multisample, it will be transposed (if needed) according to this parameter, to avoid a change of the original pitch.

Zoom

Use these buttons to change the size of the waveform shown in the diagram. When a button is greyed-out, it means the maximum or minimum value has been reached.

-  Increase the vertical size.
-  Decrease the vertical size.
-  Increase the horizontal size.
-  Decrease the horizontal size.
-  Full zoom in.
-  Full zoom out.

Changing the sample length and finding good-sounding loop points

To adjust the sample length and loop points, check the “Loop On” parameter, then use the “Start”, “Loop Start” and “End” parameters to create a fine sounding cycling loop.

For example, you may have sampled an audio groove of an exceeding length. Use the “End” parameter to cut the exceeding portion at the end of the sample, and adjust the starting point of the loop using the “Start” or “Loop Start” parameters.

Usually, checking the “Use Zero” parameter is a big help, to avoid the loop clicks due to level mismatches.

Sampling: Loop Edit

The loop is a cycling portion of a sampled sound. It is a technique used to reduce the sampling time, cycling a portion of the sound to create the sustain phase of the sound. After the attack stage, most sounds repeat the same waveform during their sustain stage. You may adjust the Loop Start point with the “Loop Start” parameter, and the Loop End point (always matching the Sample End point) using the “End” parameter.

This page lets you fine tune the loop points, by watching at the Loop End and Loop Start points matching at the center of the diagram. A good-sounding loop is shown as a continuous, non-breaking line.

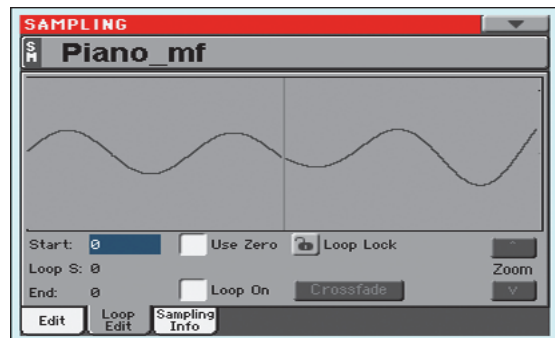

SM (Sample)

Selected sample.

Loop diagram

This diagram shows the “End” (Loop End) point on the left half, and the “Loop Start” point on the right half of the screen. Use the “End” and “Loop Start” parameters to adjust the loop.

Parameters

Start

See “Start (Sample Start)” on page 233.

Loop Start

See “Loop Start” on page 233.

End

See “End (Sample/Loop End)” on page 234.

Use Zero

See “Use Zero” on page 234.

Loop Lock

This fixes the length of the loop being edited.

Off The “Loop S.” and “End” parameters can be edited separately.

On When the “Loop S.” or “End” parameter is edited, the other one will be automatically adjusted so that the distance between them (i.e., the loop length) does not change. This is convenient when you are creating a rhythm loop to match a specific tempo.

Loop On

Use this parameter to turn the loop on or off.

On The loop is turned on, and the portion of sound included between the Loop Start and Loop End points will cycle until a key is kept pressed. If the “Loop Start” point matches the “Start” point, the whole sample is cycled.

When the loop is turned on, a vertical yellow line, showing the loop point, appears in the waveform display.

Off The loop is turned off. The sound will play from the Sample Start to the Sample End point only once, even if you keep a key pressed on the keyboard.

Crossfade

When looping the pitched sample of a complex sound such as strings or woodwinds to make the sound sustain, it is necessary to create a long loop to preserve the rich character of the sound. Crossfade Loop can be used to minimize the difference in pitch and level between the beginning and ending of the loop region, to create a natural-sounding loop. In order to solve such problems, Crossfade Loop causes the sound to change gradually from the end to the beginning of the loop.

In practice, here is how it works. A specific length (the “Crossfade Length” value) of the waveform immediately before the beginning of the loop is taken and mixed with the end portion. At this time, the waveform level of the portion immediately before the end (the length specified by “Crossfade Length”) will gradually decrease, and the waveform level immediately before the beginning of the loop will gradually increase as the two are mixed.

When the “Loop On” parameter is checked, and the “Start” and “Loop S.” parameters have different values, the “Crossfade” button becomes available.

When you touch the Crossfade button, the Crossfade Loop dialog box appears:

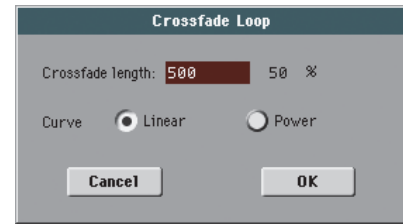

Crossfade Length

In “Crossfade Length,” specify the length of the sample that you wish to crossfade. You can enter it either as the number of samples, or a percentage (%). If you set this as a percentage, the number of samples will be calculated automatically.

If you set this to 50%, crossfade will be performed on the second half of the region between loop start and loop end.

The “Crossfade Length” cannot be greater than the smaller length between the Sample Start – Loop Start points, or the Loop Start – Sample End points.

Curve

Set “Curve” to specify how the volume will change in the crossfaded region.

Linear The volume will change linearly.

Power The volume will change non-linearly. Sometimes a setting of Linear will produce the impression that the volume has dropped in the middle of the crossfade curve. In such cases, use Power.

Sampling: Sampling Info

Use this page to see detailed info on the sample in edit. General information for the RAM memory is also available.

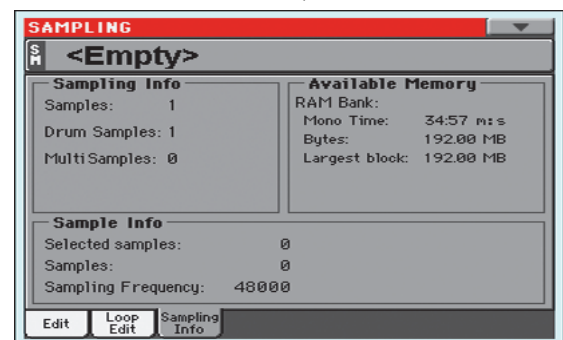

SM (Sample)

Selected sample.

Sampling Info

Samples

Number of samples in memory.

Drum Samples

Number of drum samples in memory.

Multisamples

Number of multisamples in memory.

Available Memory

RAM Bank

Pa900 comes with 192MB of Sample RAM. This is the maximum amount of Sample data that can be loaded or recorded.

Mono Time

Remaining sample memory (in seconds). This value is given for mono samples. With stereo samples, this time has to be halved.

Bytes

Remaining memory for sampling (in Bytes). This value is given for mono samples. With stereo samples, this time has to be halved.

Sample Info

Selected Samples

Size of the selected sample (in samples).

Samples

Total size of the samples in memory (in samples).

Sampling Frequency

Sampling frequency of the selected sample (in Hertz).

Time Slice

The Time Slice function lets you transform a rhythm audio groove in a series of single percussive samples, to be assigned to the Drum or Percussion track of a Style or a Song.

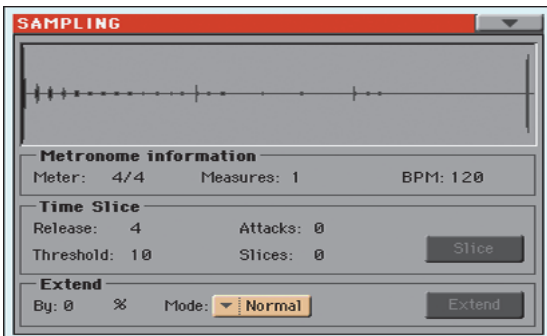

How timeslice works

Analyzing and processing. This function detects the attacks (e.g., kick and snare) inside a rhythm audio groove (a sample that loops a drum pattern), and automatically divides the audio groove into individual percussive samples.

The divided percussive samples will be automatically assigned to different keys in a multisample, and the multisample to a Sound.

Within the generated multisample, a separate sample is assigned to a different note on the keyboard, starting from C#3. By playing an ascending chromatic scale with this multisample, you could recreate the original audio groove.

A MIDI Groove will also be created, containing a sequence of notes triggering the sliced percussive samples in the same order as in the original audio groove (i.e., it plays an ascending chromatic scale starting from C#3).

When you will import this MIDI Groove to the percussive track of a Style (see "Import: Import Groove" on page 157 of the User's Manual), this sequence will let you adjust the groove's tempo without affecting the pitch of the percussive samples.

In addition to changing the groove's tempo without affecting its pitch, this lets you do the following:

- change the order in which notes are played
- change the timing
- edit the pattern notes to freely recreate a new rhythm loop.

Saving. After the slicing, you can select the Write command from the page menu, to save the Sound based on sliced samples, and the MIDI Groove containing the corresponding MIDI sequence.

- The Sound will be saved to the selected location in the User area of the internal memory. You will be able to select it as an ordinary Sound, and assign it to the Drum or Percussion track of a Style.

- The Multisample will be automatically saved to the next free available location.

- Samples will be permanently saved to the internal memory.

- The MIDI Groove will be temporarily saved to the internal memory, and will be available only when using the Import function of the Style Record mode (see "Import: Import Groove" on page 157 of the User's Manual).

Warning: All MIDI Grooves will be delete each time the Pa900 is turned off.

Ex.1 - Generating samples and MIDI Groove data:

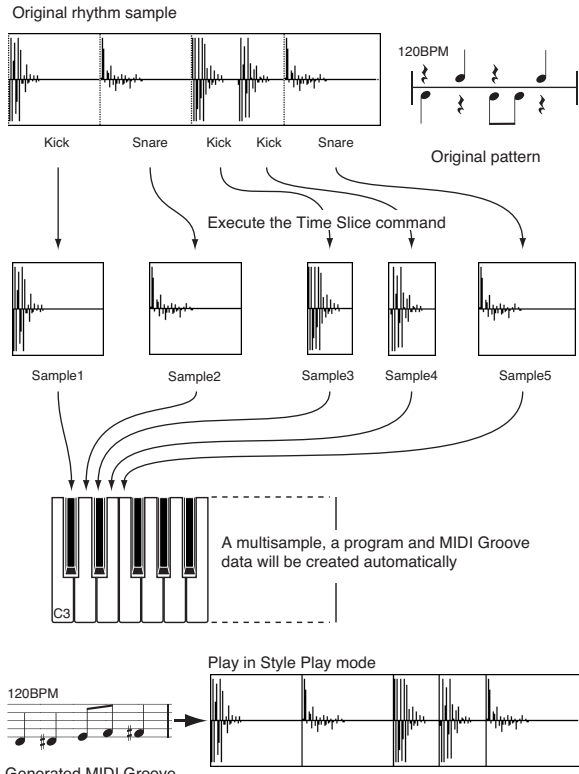

Note: Sliced samples and MIDI data are saved with a Write operation.

Ex.2 - Varying the groove's tempo

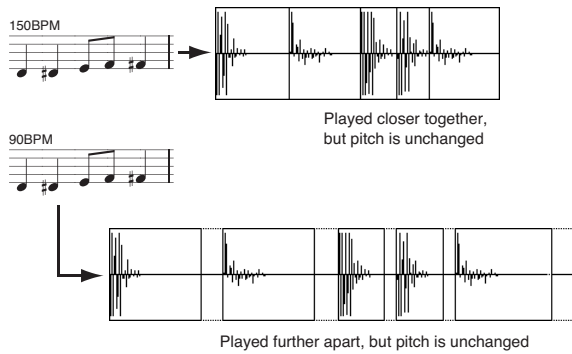

Note: To vary the groove's tempo, you must first import the generated MIDI data into the Percussion track (Import function of the Style and Pad Record mode), and assign the new generated Sound to the Percussion track.

Gaps between sliced samples, when slowing down the tempo, can be automatically filled by the Extend function, smoothing each sample's tail.

Ex.3 - Recombining MIDI notes and samples

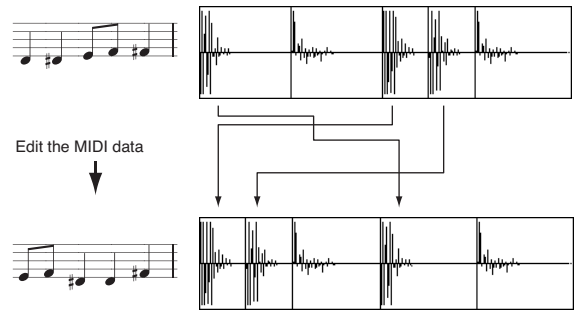

Note: To recombine notes inside the generated MIDI sequence, you must first import the MIDI data in Style or Pad Record mode, by using the "Import" function. Then, use the Event Edit to change the note order.

Sample diagram

This diagram shows the sample waveform and the slices. Here is how the sample diagram appears before the Slice:

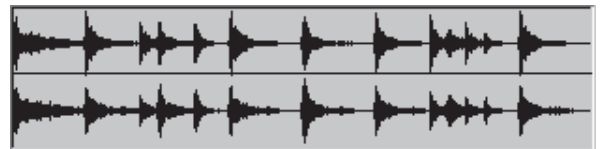

... and the same diagram after the Slice:

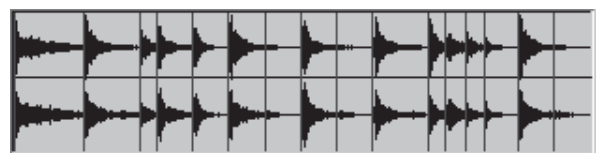

Metronome Information

Meter

Use this parameter to specify the Meter of the original sample.

Measures

Use this parameter to specify the number of measures of the original sample. Usually, you will load a groove 1- or 2-measures long.

BPM

This parameter specifies the tempo (in Beats Per Minute) of the original sample. Pa900 automatically calculates this value based on the Start, End (see page 233), Meter and Measures parameters.

The BPM can be only adjusted to values lower than the one automatically calculated. This can be useful, for example, when the actual sample is shorter than the entered Meter and Measures values.

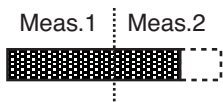

In the above example, the actual groove lasts only up to the first half of Measure 2. The recognized tempo is 130, while the real tempo is 100. Set the BPM value to 100, and a rest will be added to the end of the groove, to allow it to loop seamlessly.

Time Slice

See “The Time Slice procedure” on page 239 for more information.

Release

Adjust the value of this parameter to change the number of recognized attacks, by varying the speed needed to the Slice engine to start working again. For example, in the following example, if the Release value is too high (i.e., too long), the second attack may be lost:

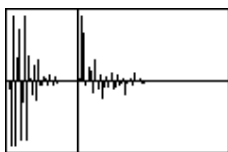

Note: After changing the Release value, you must select the Slice command again.

Threshold

This parameter varies the threshold over which the attacks are recognized (i.e., the Time Slice sensitivity). If it is too low, weaker attacks may be ignored.

Note: After changing the Threshold value, you are not obliged to select the Slice command again. The Slices value is immediately changed.

Attacks

This (non-editable) parameter shows the number of attacks recognized. More than one attack may be recognized in a single slice. Adjust the Release and Threshold parameters to change the number of recognized attacks.

Slices

This (non-editable) parameter shows the number of generated slices, i.e. generated samples and notes in the midfile. To change this value, edit the Release and Threshold parameters.

Note: You can have a maximum of 100 slices.

Slice

Select this command to execute the Slice after entering the Time Slice page, or changing the Release value. This command is “ghosted” (i.e., non-selectable) if no sample has been recorded of loaded yet.

The Time Slice operation is executed on the sample, from the “Start” to the “End” point set in the Sample Edit / Sample Record section.

Extend

See “The Extend procedure” on page 240 for more information.

When using a sliced groove with a tempo slower than the original, an annoying gap may be heard between a sample and the following one. The Extend function allows you to fix this problem by adding a “tail” to all samples, making their decay smoother and more musical.

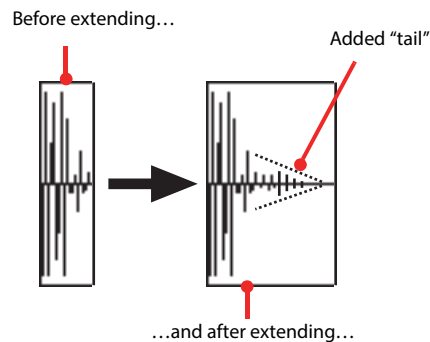

Note: You can use the Extend function only after a Time Slice operation.

Note: The Extend function increases the original sample size.

By

Use this parameter to set the length of the “tail” added to the samples (in percentage). The higher this value, the greater the size of the samples. A setting of 20-30% is usually suitable to most grooves.

Caveat: With higher “By” values, the Extend function may add audible artifacts.

Mode

This parameter specifies if the added “tail” must decay in a linear way, or sustain for a longer time and then fall suddenly.

Normal

This option is most suitable for percussive sound with a short (but not immediate) decay. The “tail” envelope is linear, and the level decays fast.

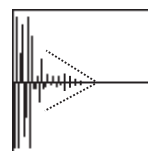

Long This option is most suitable for cymbals, whose sound should be sustained up until the next note. The “tail” envelope is sustained and falls slowly, then falls suddenly next to the end.

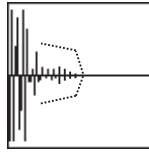

Extend

Touch this button to execute the Extend command. After you select it, it will return “ghosted”, meaning that you can’t select it again. If you change any of the parameters in this page, it will be available again.

The Time Slice procedure

Before executing a Slice operation, you must record or load a sample. Then, you may edit the sample on “Sampling: Edit”, then execute the Slice operation on this sample.

1. After recording or loading a sample, go to the Time Slice page.
2. Pa900 automatically calculates the BPM parameter, based on the given Meter and Measures values. If you know these data, set the Meter, Measures and BPM (Beats Per Minute) parameters. This would make the slicing more accurate.
3. Select the “Slice” command.

The original sample will be sliced, and each generated sample assigned to a different key:

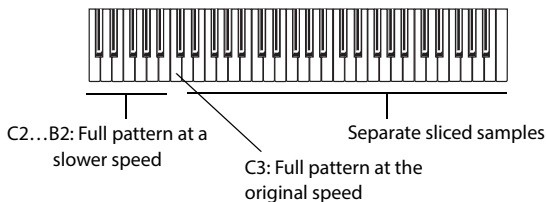

Key	Assigned sample/pattern	Speed %
C2	Full pattern cycling at various speeds	50%
C#2		53%
D2		56%
D#2		60%
E2		63%
F2		67%
F#2		71%
G2		75%
G#2		80%
A2		84%
A#2		89%
B2		94%
C3	Full pattern cycling at the original speed	100%
C#3 and above	Separate sliced samples	-

A MIDI Groove with the original pattern will also be generated. The screen will change, to show slices separated by vertical lines:

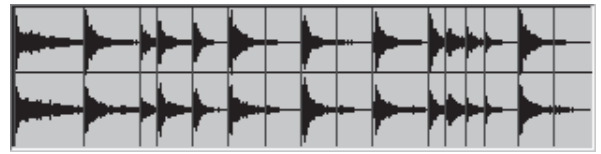

4. Test the generated sliced drum kit on the keyboard.
 - To test the full pattern at different speed, play a note from C2 (half speed) to C3 (original speed). See table above.
 - To test the single sliced samples, play notes from C#3 and above. If you play a full chromatic scale, the original pattern will be sounded.

Hint: If too many samples have been generated, and the keyboard can't fit them all, use the OCTAVE buttons to transpose the keyboard, and listen to samples exceeding the upper limit.

5. If the Slice didn't produce satisfactory results, adjust the Release parameter. If this does not produce good results, try adjusting the Threshold parameter, too. After adjusting the Release parameter, you must execute the Time Slice again.
6. Since a tempo value rounding happens when making a Time Slice operation, and the loop may not be accurate, you may need to adjust both the “Start” and “End” parameters of the “Sampling: Edit” page, to make the groove loop flawlessly. After editing these parameters, you must execute the Time Slice again.

Go on experimenting different settings! Editing an audio groove is a pure matter of experimentation.

7. When the Slice is completed, you can save the sliced samples and the MIDI Groove, or use the Extend function to improve the quality of the slices.

Select the Write command from the page menu. The Write Slice dialog box will appear (see “Write Slice dialog box” on page 244). Assign a name to the new Sound, and save it to an User Sound location.

A MIDI Groove with the same name will also be saved to the internal memory. Be warned, that this area will be deleted when turning the instrument off. Convert it to an internal Style pattern, by using the Import function of the Style or Pad Record mode, before turning the instrument off.

- To improve the quality of the slices, use the Extend function (see “Extend” below).
8. After saving, you may press RECORD to exit the Sampling mode.
 9. After exiting the Sampling mode, you may load the generated MIDI Groove by using the Import function of the Style Record mode (see “Import: Import Groove” on page 157 of the User's Manual for more information).

The Extend procedure

1. Set the **By** parameter, according to the tempo of the groove you will use. If you will slow down the groove very much, assign higher values to this parameter, otherwise you may assign lower values.
2. Select the Extend **Mode**. “Long” is more suitable for cymbals.
3. Select the Extend command.
4. After the Extend operation is complete, test the full pattern at different speed, by playing notes from C2 (half speed) to C3 (original speed). See table on page 239.
5. If the Extend didn't produce satisfactory results, change the settings. Any previously made change will be deleted.
6. When the Extend is completed, you can save the sliced and extended samples and the resulting MIDI Groove to the internal memory.

Select the Write command from the page menu. The Write Slice dialog box will appear (see “Write Slice dialog box” on page 244). Assign a name to the new Sound, and save it to an User Sound location.

A MIDI Groove with the same name will also be saved to a reserved area of the internal memory. Be warned, that this area will be deleted when turning the instrument off. Convert it to an internal Style pattern, by using the Import function of the Style Record mode, before turning the instrument off.

7. After saving, you may press RECORD to exit the Sampling mode.
8. After exiting the Sampling mode, you may load the generated MIDI Groove by using the Import function of the Style or Pad Record mode (see “Import: Import Groove” on page 157 of the User's Manual for more information).

Multisample: Edit MS

The Multisample is a way of organizing several samples on the keyboard. Each sample is assigned to a Keyboard Zone (or Index), with a higher and a lower limit.

A Multisample is then assigned to a Sound (see “Basic: OSC Basic” on page 206), where it is enriched with several performance parameters, like Amplitude Envelope, LFO, Filters, etc...

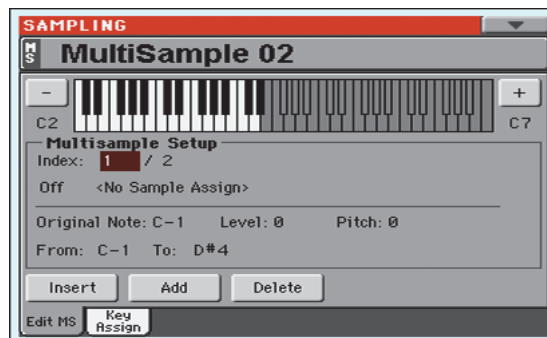

MS (MultiSample)

Touch this area to open the Choose Multisample window, and select one of the available multisamples in memory.

Keyboard diagram

This diagram shows the selected Index/Zone (highlighted), and its Original Note (in red). Use the big “-” and “+” button on its side to scroll the diagram one octave lower or upper.

Multisample Setup

Index

Index number of the selected Zone of the multisample / total number of Zones in the multisample. A Zone always corresponds to a single sample.

When you play a note on the keyboard, the corresponding index number is automatically selected.

Sample Number / Name

Number / name of the sample assigned to the selected zone of the multisample.

Original Note

Use this parameter to automatically transpose the assigned sample on the keyboard. When you play this note, the sample sounds exactly as it was recorded.

At first, it matches the “OrigNote (Original Note)” value assigned when editing the sample (see page 234). This will speed up the programming.

The note set with this parameter is also shown in red in the virtual keyboard diagram.

Level

Relative level of the selected zone. This value can only be negative.

Pitch

Fine tuning of the selected sample in cents (1 cent = 1/100 of a semitone).

From ... To

Range of the selected Zone (or Index). The minimum size is one key. When reducing the range of a zone, the adjacent one is automatically increased to fill the gap.

Hint: To create a silent zone, create it and assign no sample to it.

Buttons

Insert

Touch this button to split the current zone in half, and create a new zone (Index) on the left of the selected one.

Add

Touch this button to add a new zone (Index) after the last one.

Delete

Touch this button to delete the selected Zone/Index. The zone on the right of the deleted one is automatically extended to fill the gap.

Multisample: Key Assign

Use this page to see and edit the samples assigned to each Keyboard Range/Index in the multisample. This page gives a better display of the assigned samples and their range on the keyboard.

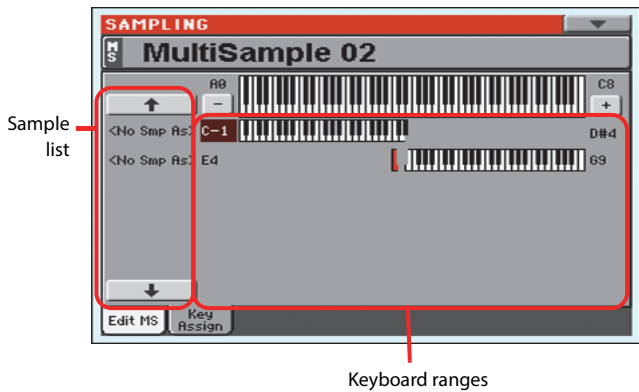

MS (MultiSample)

See “MS (MultiSample)” on page 240.

Sample list

List of samples assigned to the selected multisample. Use the big button with an arrow on top and to the bottom of the list to scroll the list up or down.

Keyboard ranges

Next to each sample name the low and high Zone limits appear. Edit these values to change the Zone range. The Original Note is shown in red.

Page menu

Touch the page menu icon to open the menu. Touch a command to select it. Touch anywhere in the display to close the menu without selecting a command.

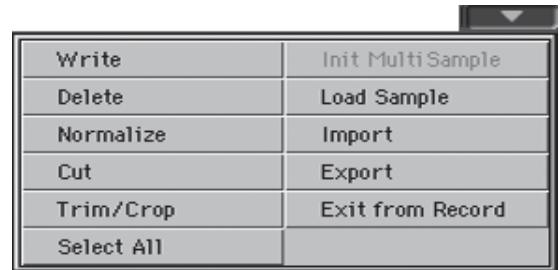

Write

Select this command to open the Write Sample, Write Multisample or Write Slice dialog box (depending on the page you are in), and do the following:

- **Write Sample:** Saves the sample to the internal memory. See “Write Sample dialog box” on page 243, for more information.
- **Write Multisample:** Saves the multisample to the internal memory. See “Write MultiSample dialog box” on page 243 for more information.
- **Write Slice:** After a Time Slice operation, saves the Sound, Multisample and the sliced Samples to the internal memory. See “Write Slice dialog box” on page 244 for more information.

Delete

Select this command to open the Delete Sample or Delete Multi-Sample dialog box (depending on the page you are in):

- **Delete Sample:** Deletes one or all Samples and Multisamples from the internal memory. See “Delete Sample dialog box” on page 244 for more information.
- **Delete MultiSample:** Deletes a Multisample, or all Samples and Multisamples from memory. See “Delete Multisample dialog box” on page 244 for more information.

Normalize

Select this command to automatically rescale the level of the selected sample. Peaks will be raised to -0dB (i.e., maximum volume before clipping), while the remaining parts of the sample will be proportionally raised.

Normalization optimizes the sample’s level relative to other samples, making all samples sound more uniformly. It also helps optimizing signal/noise ratio, by preventing further stages of amplification from increasing any residual noise.

Cut

Select this command to cut the selected part of the sample (inside the “Start” and “End” points).

Trim/Crop

Select this command to cut all parts of the sample out of the selected range (i.e., out of the “Start” and “End” points).

Select All

Use this command to select the whole sample.

Init Multisample

Only available in the Multisample page. Select this command to create a new, blank multisample. Only one Zone will be available, with no sample assigned.

Load Sample

Use this command to load single samples (mono or stereo), in KSF, AIFF or WAVE format.

Warning: By loading new samples, the sample currently in edit will be lost if not saved. Before loading, use the Write command to save the sample in edit, if not yet saved, to the internal memory.

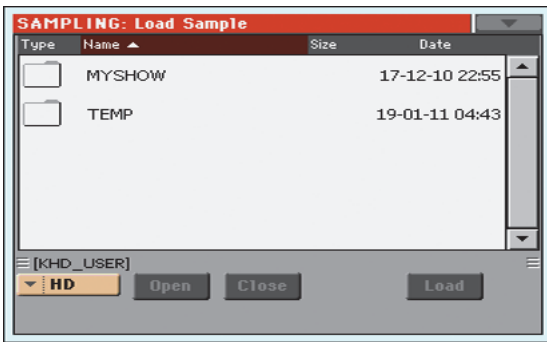

The samples are loaded to the editor. Before leaving the Sampling mode, use the Write command to save any unsaved sample to the internal memory as a New Sample.

- “KSF” is Korg’s native sample format, used by the Trinity and Triton series of workstations, as well as the Pa-series arrangers. The file name must have the “.KSF” extension.
- “AIFF” is the Apple Mac’s preferred format for audio. The file name must have the “.AIF” extension.
- “WAVE” is the Microsoft Windows preferred format for audio. The file name must have the “.WAV” extension.

Note: You can only load samples in a 8 or 16-bit resolution, and a sampling frequency rate from 11,025 to 48,000Hz. Loaded samples always preserve their original resolution.

Note: If the sample exceeds the maximum size allowed by the Pa900 (1,048,576 samples, corresponding to 1 Megasample, either mono or stereo), it will be truncated. A warning will appear in the display.

Hint: While in this window, you can use the Search function, allowing for searching a Sample file in the various media.

Import

Use the Import command to import Sounds and Multisamples (including the contained Samples) in formats other than the native Pa-Series format.

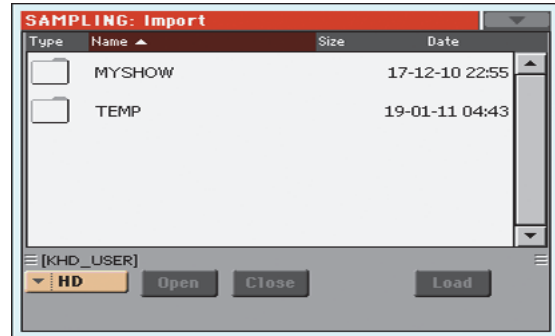

With this command, you can import the following formats:

- “PCG” is Korg’s native Program format, used by the Triton series of workstations. The file name has the “.PCG” extension. *Note that Drum Kits cannot be imported.*

When importing a PCG file, you can choose between a single Program or a whole bank:

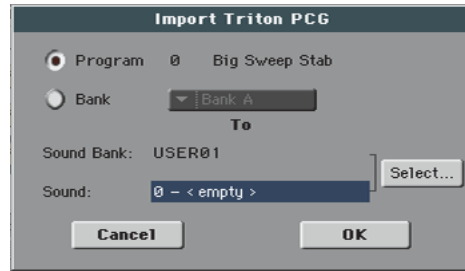

Choose **Program** to choose a single Program (corresponding to a Pa-Series Sound); touch the Program number and dial in the corresponding number. Choose a target Sound location where to load the imported Program.

Choose **Bank** to import all the Programs from the selected bank. Touch the Sound Bank name to choose a target bank where to load the imported Programs.

- “KMP” is Korg’s native multisample format, used by the Trinity and Triton series of workstations. The file name has the “.KMP” extension.
- “SF2” is a sound bank format by Creative Labs. The file name has the “.SF2” extension. Multisample data are imported. *Due to the deep differences with Korg’s own format, some Instruments from the SF2 file could not be imported (for example, Instruments with overlapping zones).*

When importing an SF2 file, you can choose between a single Multisample or the whole bank:



Choose **MultiSample** to choose a single Multisample (i.e., SF2 Instruments); touch the Multisample number and dial in the corresponding number.

Choose **Complete bank** to import all the Multisamples from the selected bank.

Check **Override Sample Names** if you want to assign the Sample names a progressive number. In this case, when importing a Multisample whose name is, for example, “Piano”, you will have all Samples renamed as “Piano_001”, “Piano_002”, and so on.

Hint: If you get a messages warning there isn't enough memory to load all Samples or resources, return to the main Sampling page and choose the Delete command to clean the Sample memory, then retry. Please note that importing single Multisamples is the safest way to avoid filling the memory with unnecessary data.

Imported Sounds and Multisamples are automatically stored in the internal memory, and will not be lost when turning the instrument off.

Note: While Pa900 and Triton share most of their internal Multisamples, some of them may differ. While reading a PCG file, Pa900 tries to use exactly the same Multisamples as in Triton. If this is not possible, it looks for a similar Multisample. If this too is not possible, an <empty> Multisample will be selected. Enter the Sound mode, and select a Multisample suitable for the imported Program.

Note: Not all Triton's PCG data are imported. Insert FX, EQ, Arpeggio, Combi, Global and Drum Kit data are not loaded.

Note: You cannot import Drum Kits.

Note: Multisample may contain various Samples. They are assigned to the same keys as in the original file.

Hint: When importing a KMP file, take note of the selected Multisample name; you will need it in Sound mode, when assigning the Multisample to a new Sound.

Hint: While in this window, you can use the Search function, allowing for searching a Sample file in the various media.

Export

Depending on whether you are in the “Sample Edit / Sample Record” or “Multisample” section, this command allows you to export a sample in one of two popular computer audio file formats (WAVE and AIFF), or a multisample in a Korg “.KMP” file.

See “Export Sample page” on page 245, or “Export Multisample page” on page 245 for more information.

Exit from Record

Choose this command to exit from the Sampling mode.

Write Sample dialog box

Open this dialog box by selecting the Write command from the page menu, while in the Sample Edit / Sample Record section. In this dialog box you can save the sample to the internal memory, so that it will be preserved when Pa900 is turned off.

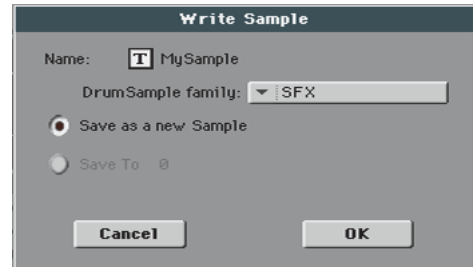

To assign a different name to the sample, touch the **T** (Text Edit) button to open the Text Edit window.

In case you are saving a percussive sample, choose a Drum Sample family to be assigned to.

Select an option to choose a memory location where to save the sample:

- Select “Save as a new Sample” to save to a new location.
- Select “Save to” to overwrite an existing location. **Warning:** The older sample at the same location will be deleted!

Write MultiSample dialog box

Open this dialog box by selecting the Write command from the page menu, while in the Multisample section. In this dialog box you can save the multisample to the internal memory. Multisamples are a way to organize samples on the keyboard, and are used by Sounds as their basis.



To assign a different name to the multisample, touch the **T** (Text Edit) button to open the Text Edit window.

Select an option to select a memory location where to save the sample:

- Select “Save as a new MultiSample” to save to a new location.
- Select “Save to” to overwrite an existing location. **Warning:** The older multisample at the same location will be deleted!

Write Slice dialog box

Open this dialog box by selecting the Write command from the page menu, while in the Time Slice page. In this dialog box you can save the Sound, sliced Samples and Multisample generated by the Time Slice function, together with the generated MIDI Groove.

The Sound will be saved to the selected User bank location in the internal memory. The Multisample will be saved to a free location in the same memory. Samples will be saved to the internal memory.

Note: The MIDI Groove is automatically saved in a reserved, temporary location, and is automatically deleted when turning the instrument off. So, import it (by using the “Import: Import Groove” function in Style or Pad Record mode, see page 157), before turning the instrument off.

Warning: The older Sound at the target location will be deleted!

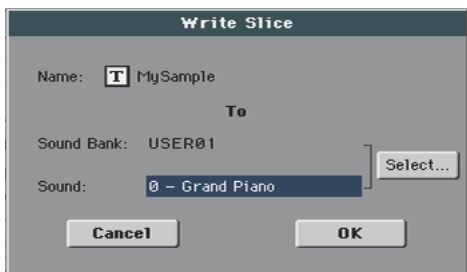

Name

To assign a different name to the Sound, touch the **T** (Text Edit) button to open the Text Edit window.

Sound Bank

Target bank of Sounds. Each bank corresponds to one of the SOUND buttons. You can use the VALUE dial to select a different bank.

Sound

Target Sound location in the selected bank. You can use the VALUE dial to select a different location.

Select...

Touch this button to open the Sound Select window, and select a target location.

Delete Sample dialog box

Open this dialog box by selecting the Delete command from the page menu, while you are in any page of the Sample Edit/Sample Record section.



Selected

Select this command, and select a sample number, to delete just one of the samples from the internal memory.

Not assigned to any Multisample/Drumkit

Select this command to delete only samples not yet assigned to a Multisample or Drum Kit.

Note: Use this option with care, since you may delete samples you would like to preserve, that have not yet been assigned to a multi-sample or drumkit. Use it only when you are sure all desired samples have been assigned to a multisample or drumkit.

All Samples, Multisamples, Drum Samples

Select this command to delete all samples, multisamples and drum samples from the internal memory. This operation completely resets the RAM, and may be used to “clean-up” any trouble.

Delete Multisample dialog box

Open this dialog box by selecting the Delete command from the page menu, while you are in any page of the Multisample section.

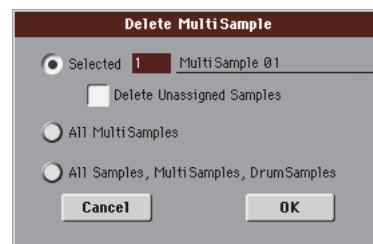

- Select “Selected”, then a multisample number, to delete just one of the multisamples from memory.

Check the “Delete Unassigned Samples” option, to also delete all samples not assigned to a different multisample. By checking this option, all samples assigned to the multi-sample you are deleting, and all samples not assigned to a different multisample, will be deleted.

Note: Use this option with care, since you may delete samples you would like to preserve, that have not yet been assigned to a multisample or drumkit. Use it only when you are sure all

desired samples have been assigned to a multisample or drumkit.

- Select “MultiSamples” to delete all multisamples. No samples will be deleted, including those associated with the deleted multisamples.
- Select “All Samples, Multisamples, Drum Samples” to delete all samples, multisamples and drum samples from the internal memory. This operation completely resets the RAM, and may be used to “clean-up” any trouble.

Export Sample page

Open this page by selecting the Export command from the page menu, while you are in any page of the Sample Edit/Sample Record section.

First of all, select the target location where to export the sample:



Then touch the Save button to see the Export Sample dialog box:

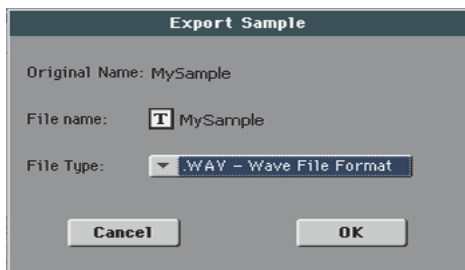

Original Name

Name of the sample being exported.

File Name

Name of the generated file on the storage device.

File Type

Either of the file types you can choose as the file format.

- | | |
|------|---|
| WAV | Microsoft Wave format, very common on Windows PCs. |
| AIFF | Apple's Audio Interchange File Format, standard on the Mac. |

Export Multisample page

Open this page by selecting the Export command from the page menu, while you are in any page of the Multisample section.

First of all, select the target location where to export the multisample:



Then touch the Save button to see the Export MultiSample dialog box:

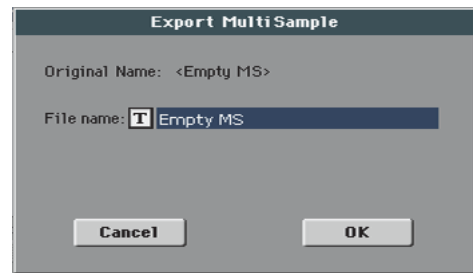

By using this function, you can export from the internal memory the Multisample in edit in the Multisample section, and all linked samples. The Export operation generates a “.KMP” file (Korg’s proprietary file format for multisamples), and a folder containing a series of “.KSF” files (Korg’s proprietary file format for samples) inside the same directory.

Note: When exporting a stereo multisample, be careful to assign a different name to the Left and Right channel files, to avoid overwriting. A “-L” and “-R” suffix is usually added after the name of this kind of files.

Merging Samples from various sources

When you load a .SET folder, all User Samples in memory are deleted. To merge samples from several sources, do the following.

1. Load a .SET folder containing samples you want to merge with other samples.
2. Load single Sounds from other .SET folders.
3. Load or import Samples from other sources (Trinity, Triton, Wav, Aiff files).
4. Save the .SET folder, over the same or a new .SET folder.

Global mode

The Global mode is where you can set global functions. This mode overlaps the current operating mode (Style Play, Song Play, Sequencer, Sound).

Overview on the Global mode

The Global mostly contains a series of global parameters applied to the whole instrument (or to each separate operating mode) as a whole, that are automatically written to memory after editing. Examples of global parameters are the Master Tuning or the Power Management.

Global mode also contains parameters that are applied to the instrument as a whole, but can be saved as a “preset”, that can later be loaded to change all parameters at once. Examples of this kind of parameters are the MIDI channel assignment, saved into the MIDI Presets, or the Master EQ settings, saved into the Master EQ Presets.

Parameters in the Global mode, either automatically memorized or saved to a preset, are opposed to “local” parameters that you can access in the other operating modes. Examples of local parameters are the Sounds assigned to a track or the function assigned to an Assignable Switch, both saved into a Performance or STS (two types of preset containing musical data relevant to the selected operating mode).

Note: Saving or loading a “.SET” folder may also save or load the Global file. Parameter changing may be avoided by turning the Lock on for any single parameter (or groups of parameters in the Lock page of the Global mode, see “General Controls: Lock” on page 249).

Main page

There is no main page in the Global edit mode. When pressing EXIT, you exit the Global mode, and the underlying operating mode in the background is recalled.

Edit menu

From any page of the Global mode, press the MENU button to open the Global edit menu. This menu gives access to the various Global edit sections.

When in the menu, select an edit section, or press EXIT to exit the Global mode.

When in a page, press EXIT to go back to current operating mode in the background (Style Play, Song Play, Sequencer, Sound).

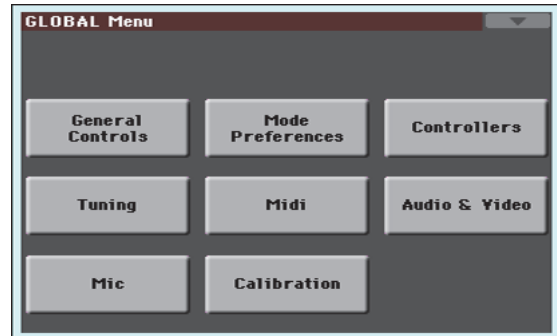

Each item in this menu corresponds to an edit section. Each edit section groups various edit pages, that may be selected by touching the corresponding tab on the lower part of the display.

Note: The Global mode is not available while in Record mode (Style Record, Pad Record, Song Record, Sampling).

Edit page structure

All editing pages share some basic elements.

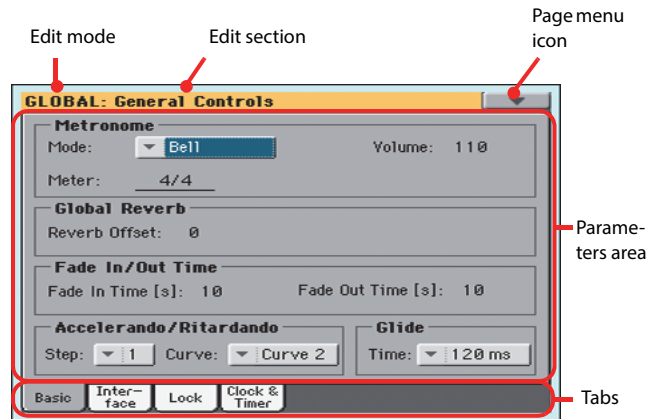

Edit mode

This indicates that the instrument is in Global mode.

Edit section

This identifies the current edit section, corresponding to one of the items of the edit menu (see below).

Page menu icon

Touch this icon to open the page menu (see below).

Parameters area

Each page contains various parameters. Use the tabs to select one of the available pages. For detailed information on the various types of parameters, see sections starting below.

Tabs

Use tabs to select one of the edit pages of the current edit section.

General Controls: Basic

This page contains various general parameters, setting the status of the keyboard, the fade in/out, and the accelerando/ritardando.



Metronome

Mode

Use this parameter to activate the metronome's type of accent.

Normal	No accent can be heard.
Accent	The first beat of each measure is accented.
Bell	A bell sound is heard at the first beat of each measure.

Volume

Use this parameter to set the volume of the metronome.

0...127 Volume level.

Meter

Use this parameter to choose the meter (time signature) of the Metronome.

1/1...16/16 Selected Meter.

Global Reverb

Reverb Offset

This is the master offset for all reverbs. Use it to adjust reverb tails to the room where you are playing. Use negative values when you are in a very reverberant room, positive values if the room is too dry.

By using this global control, you are not obliged to change the reverb time in each single Performance, STS, Style Settings, or Song.

-50	Less reverb.
0	Standard reverb.
+50	More reverb.

Fade In/Out Time

These parameters allows you to set the speed for the Fade In/Out function.

Fade In Time

Time for a full fade in (from zero to maximum volume), after you press the FADE IN/OUT button.

5...20 Fade time (in seconds).

Fade Out Time

Time for a full fade out (from maximum volume to zero), after you press the FADE IN/OUT button.

5...20 Fade time (in seconds).

Accelerando/Ritardando

These parameters lets you adjust the speed of the Accelerando and Ritardando functions.

Step

Speed of the Tempo change (from 1 to 6). With higher values, the step change is greater, and the speed will change faster. With lower values, the step change is smaller, and the speed will change more slowly.

Curve

Accelerando/ritardando curves (from 1 to 3). Experiment the various options, to see the one that best fit your taste.

Glide

Glide is a function you can assign to a footswitch. When the pedal is pressed, affected notes on Upper tracks are bent down, according to settings for the Pitch Bend on the same tracks. When the pedal is released, notes return to the normal pitch, at the speed defined by the "Time" parameter.

To change Pitch Bend values for each Upper track, see the "PB Sensitivity" parameter in the Style Play mode (see page 116)

Time

Time needed to notes affected by the Glide to return to the normal pitch.

General Controls: Interface

This page contains parameters related to user interface.



Language

Language

Use this pop-up menu to select one of the available languages for the on-screen keyboard.

Note: Some of the characters can only be used when editing Song-Book Entry names.

Change button

To apply the selected language to the onscreen keyboard, touch this button and restart the instrument as described below.

How to select a language

1. Since Pa900 must be restarted at the end of this procedure, be sure to first save all unsaved data.
2. While in this page, select a language from the pop-up menu.
3. The “Change” word will start flashing in red. Touch it.
4. A message will ask you to reboot the Pa900. Touch OK to close the message window.
5. Set Pa900 to standby, then on again.

Background Color

Color

Use this parameter to choose a different color scheme for the display.

Display Hold

On/Off

When this parameter is checked, if you open a temporary windows (like the Sound Select window), it remains in the display until you press EXIT or an operating mode button. When it is not checked, any temporary window closes after a certain time.

Program Change

Show

Check this parameter to show Program Change numbers next to Sound names in the Sound Select window. By default, this parameter is turned on.

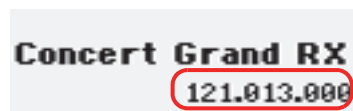

Note: Program Change numbers are always shown in the various Track Info areas.

Track Activity

Show

Use this parameter to turn on/off the Track Activity display. When it is turned on, you can monitor events coming from the tracks or the MIDI inputs. Incoming events are shown by the color changing on each track's label.

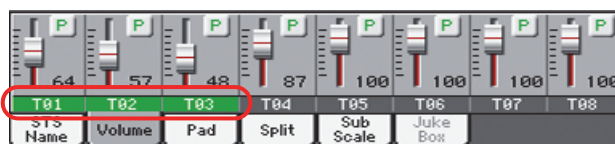

Auto Select

Style

When this parameter is checked, the latest selected Style is immediately selected when pressing the STYLE button corresponding to the bank.

This way, you can assign your preferred Style to each control panel's button, and select it just with a single press.

However, the Style Select window still appears when you press one of the STYLE buttons corresponding to the bank, so you can select a different item if desired.

Performance

When this parameter is checked, the latest selected Performance selected in a bank is immediately selected when pressing the PERFORMANCE button corresponding to the bank.

This way, you can assign your preferred Performance to each control panel's button, and select it just with a single press.

However, the Performance Select window still appears when you press one of the PERFORMANCE buttons corresponding to the bank, so you can select a different item if desired.

Save

Touch this button to save the current Style and Performance assignment. You will find the saved assignment when turning the instrument on again.

General Controls: Lock

This page, split in more panes that can be selected by means of the corresponding side tabs, contains all the available locks. Locks prevent parameter values to be changed when choosing a different Performance, Style or STS.

Locks

All the available locks, listed below. Lock them to prevent changes due to selecting different elements. These locks are also found in various other pages, next to the locked parameter.

Hint: To save the status of parameters that have to remain unchanged, set them and save the MY SETTING Performance (automatically selected when turning the instrument on). After having saved the startup Performance, go to these pages and lock the parameters that must remain unchanged.

Tuning pane

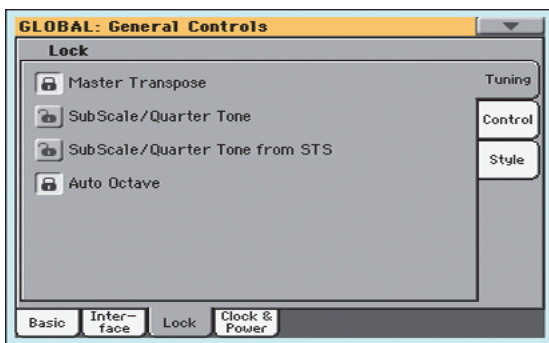

Master Transpose

When this lock is closed, Master Transpose is not automatically changed when selecting a different Performance or Style, or a different SongBook Entry. Also, this lock prevents a Standard MIDI File generated with an instrument of the Korg Pa-Series to change the Master Transpose.

(See “Master transpose” on page 107).

Sub Scale/Quarter Tone

When locked, selecting a Performance or STS, or a SongBook Entry, will not change the Sub-Scale or Quarter Tone value.

(See “Sub-Scale panel” on page 112).

SubScale/Quarter Tone from STS

When locked, selecting an STS will not change the Sub-Scale or Quarter Tone settings. The STS will change sounds and effects but not the scale.

(See “Sub-Scale panel” on page 112).

Auto Octave Depending on the status of this lock, the Upper tracks can be automatically transposed when turning the SPLIT on and off.

- If locked, turning the SPLIT on or off will not change the Upper tracks transposition.
- If unlocked, when turning the SPLIT button off (Full keyboard mode) the Upper tracks Octave Transpose will be automatically set to “0”. When

turning the SPLIT button on (Split keyboard mode) the Upper tracks Octave Transpose will be automatically set to “-1”.

Control pane

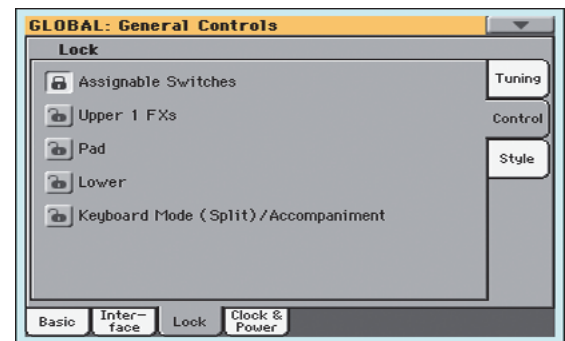

Assignable Switches

When locked, selecting a Performance or STS will not change the functions assigned to the Assignable Switches.

(See “Pad/Switch: Switch” on page 125).

Upper 1 FXs In Sound mode, you can assign a Sound to the FX B Group. When you assign a new Sound to the Upper 1 track, the FX B settings and Master FX send levels saved with that Sound can be automatically selected, overriding Performance/STS settings for this track. Whether Sound or Performance/STS effect parameters will be considered, it depends on the status of this lock.

- If the Upper 1 FX Lock is turned on, when assigning a new Sound to the Upper 1 track, Performance/STS parameters are left untouched; selected effects, and FX Send values, are not changed.
- If the Upper 1 FX Lock is turned off, when assigning a new Sound to the Upper 1 track, Sound parameters are considered; selected effects, and FX Send values, are changed according to the Sound’s stored data.

Note: If the effects associated to the selected Sound are not compatible with the effects already assigned to the FX B block, the Master FX Send values on the other Keyboard tracks will be automatically set to zero.

For example, assume a chorus effect is assigned to the Master 2 FX processor. If the new Sound assigns a distortion effect to the Master 2 FX processor, the Master 2 FX Send value on the Upper 2, Upper 3, and Lower tracks will be set to zero, to avoid these tracks sound in the wrong way. This way, the Upper 1 track (usually the most important one for solo playing) will sound with the needed effect, while the other Keyboard tracks will just sound dry.

Pad

When locked, selecting a Style or SongBook Entry will not change the Pad assignment.

(See “Pad/Switch: Pad” on page 125).

Lower When this lock is closed, the Lower track remains unchanged when a different Style, Performance or STS is selected.

This is useful if, for example, you prefer to always play with the left hand muted and reserved only to the chords.

Hint: If you want the same Lower settings to be used during all your shows, save your preferred Lower settings to the MY SETTING Performance (automatically selected on startup).

Keyboard Mode (Split)/Accompaniment

When this lock is closed, the status of the SPLIT button (therefore of the keyboard mode) and the ACCOMP. button remains unchanged when a different Performance or STS is selected.

This is useful if, for example, you prefer to always play in Full Keyboard, with chords recognized on the whole keyboard range.

Hint: If you want the same Keyboard Mode and Lower Scanning settings to be used during all your shows, save your preferred settings to the MY SETTING Performance (automatically selected on startup), then close this lock.

Style pane



Style Tracks Volume

When this lock is closed, the Style tracks' volume do not change when a different Style is selected.

This is useful when you create your own User Styles, and prefer to dynamically adjust the volume by using the sliders as in a mixer. It is not recommended with Factory Styles, each one already mixed at its best right at the factory.

Style Tracks Play/Mute Lock

When this lock is closed, selecting a Style does not cause the Play/Mute status of the Style tracks to be changed. This way, you can, for example, turn the bass track off during a whole show, to allow your bassist to play the part live. Also, you could mute all Acc tracks, to only play with the Drum and Bass tracks.

Style Element When this lock is closed, the selected Style Element (Variation, Intro...) will not change when choosing a different Style.

This lock has no effect on the Styles automatically selected when choosing a SongBook Entry. The Style Element memorized in the SongBook Entry is always selected.

Bass Inversion

When locked, selecting a Performance or STS will not change the Bass Inversion status.

(See "BASS INV. (Bass Inversion)" on page 11).

Manual Bass When locked, selecting a Performance or STS will not change the Manual Bass status.

General Controls: Clock & Power

Date & Time

Pa900 includes a battery-backed system calendar and clock. This allows for automatically adding a time-stamp to the files when they are created or edited.



Note: When you edit a resource file (Sounds, Styles...), all items in the same bank have their modification date changed. For example, if you edit a single Style in the “Pop” bank, all Styles in that bank will take the new modification date.

Month

Use this pop-up menu to choose a month.

Day

Use this numeric field to input the day of the month.

Year

Use this numeric field to input the year.

Time

Use these numeric fields to input the time, in the “hour:minute:second” format.

Apply

After having edited all calendar and time fields, touch this button to apply the changes.

Auto Power Off

Pa900 can automatically enter standby after two hours of being unused, to save power and help preserving the environment.

On

When this parameter is checked, a few minutes before automatic standby a message will warn you that the instrument is going to be put in standby. All unsaved data currently in editing or recording will be lost.



At this message, you can let the instrument enter standby, or you can touch the display, press any button on the display, or play the keyboard to leave it turned on and continue using it.

Mode Preferences: Style

In this page you can set various general parameters for the Style Play mode.

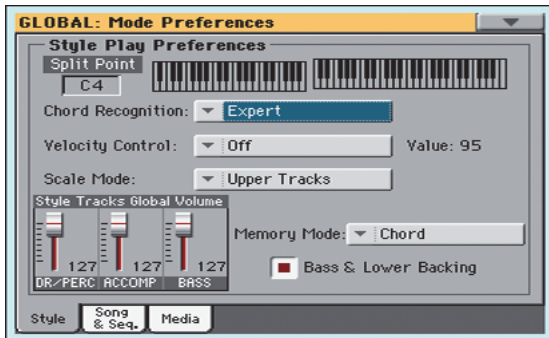

Split Point

Use this parameter to select the global split point. This point is independent of any Performance or STS.

See “Split panel” on page 112 for more information.

Chord Recognition

This parameter defines how chords are recognized by the auto-accompaniment engine.

Depending on the status of the CHORD SCAN section, the Chord Recognition mode is automatically set as in the following table:

Chord Recognition Mode	
CHORD SCAN = LOWER	CHORD SCAN = UPPER/FULL KEYBOARD (LOWER+UPPER)
One Finger	Fingered (3 Notes)
Fingered (1 Note)	Fingered (3 Notes)
Fingered (3 Notes)	Fingered (3 Notes)
Expert	Expert

One Finger You can compose a chord using a simplified chord playing technique:

- Play a single note for a Major chord to be recognized.
- Play the root note, plus a white key on the left, for a 7th. For example, play C3 + B2 for a C7.
- Play the root note, plus a black key on the left, for a Minor chord. For example, play C3 + Bb2 for a C minor.
- Play the root note, plus a white and a black key on the left, for a Minor 7th. For example, play C3 + B2 + Bb2 for a C min 7.

Fingered (1 Note)

With the Lower chord scan mode, play one or more notes to compose a chord. A full Major chord will be recognized when a single note is played.

With the Full or Upper chord scan mode, play at least three notes to compose a chord.

Fingered (3 Notes)

Always play three or more notes for a chord to be recognized.

Expert

With the Lower chord scan mode, play two or more notes for a chord to be recognized. With the Full or Upper chord scan mode, play at least three notes.

If you play just one note, a unison will be played. If you play a fifth, a “root+5th” chord will be played.

With this mode, you can play rootless and slashed chords, often used in jazz, fusion, modern pop and light music. This type of chord recognition is very useful to play piano chords typical of jazz piano players. You don’t always need to play the root note, doubling the note already played by the bass track.

Velocity Control

Set this parameter to trigger one of the following functions simply by playing louder with your left hand. When playing with a velocity value higher than the value set by the “Velocity Control Value” parameter (see page 252), the selected function will be activated.

This function only works when the SPLIT LED is turned on.

Off The function is turned off.

Break When playing with a velocity higher than the trigger value on the Lower track, the Break is automatically triggered.

Start/Stop You can start or stop the Style by playing harder on the keyboard.

Bass Inversion When playing with a velocity higher than the trigger value, the Bass Inversion function will be activated or deactivated.

Memory When playing with a velocity higher than the trigger value, the Memory function will be activated or deactivated.

Velocity Control Value

Use this parameter to set a velocity threshold over which to automatically trigger the Style Start/Stop or select one of the other functions (see “Velocity Control” above).

Scale Mode

This parameter defines which tracks are affected by the selected alternative scale (see “Scales” on page 356).

Keyboard Tracks

The scale will affect all Keyboard tracks.

Upper Tracks The scale will only affect Upper 1-3 Keyboard tracks.

All Tracks The scale will affect all tracks (Keyboard, Style, Pads).

Memory Mode

This parameter sets the way the MEMORY button works.

Chord When the MEMORY LED is on, recognized chords are kept in memory even when raising your hand from the keyboard. When the LED is off, chords are reset when raising your hand.

Chord + Lower

When the MEMORY LED is on, recognized chords are kept in memory, and the Lower sound is held until the next note or chord is played. When the LED is off, both the chord (and therefore the accompaniment) and Lower sound are cut when raising the hand from the keyboard.

Fixed Arr. + Lower

When the MEMORY LED is on, recognized chords are kept in memory, and the Lower sound is held until the next note or chord is played.

When the MEMORY LED is off, the Lower sound is cut when raising the hand from the keyboard; on the contrary, the chord is kept in memory (so that the accompaniment can continue to play).

Bass & Lower Backing

With this function, you can play a simple accompaniment with your left hand. For this to work, the SPLIT LED must be turned on, and the Style must not be running. By default, this function is turned on.

On When the Style is not running, and you play a chord with your left hand, the chord is played by the Lower Sound (even if it is muted), while the chord root is played by the Bass Sound. When you start the Style, the normal behavior is restored.

When the Bass & Lower Backing function is active, the Backing **BACKING** icon appears in the Lower track Sound's area.

Off No Bass Sound is added when the Style is not running. The Lower track can be heard only if it is not muted.

Style Tracks Global Volume

In Style Play mode, the volume of the grouped Style tracks is a global offset of the values memorized in the Style. When you choose a different Style, this offset will not change, and the average volume of the Style tracks remains the same.

These controls allows you to globally set the balance between the Drum/Percussion, Bass and Accompaniment tracks. For example, if you prefer Drums and Bass to be prominent to make them have more 'punch', you can lower the grouped Accompaniment tracks.

Changes are not memorized to a Performance or to the current Style Settings. Instead, they are memorized as a global parameter.

0...127 Volume level.

Mode Preferences: Song & Sequencer

In this page, you can set various general parameters for the Song Play and Sequencer modes.

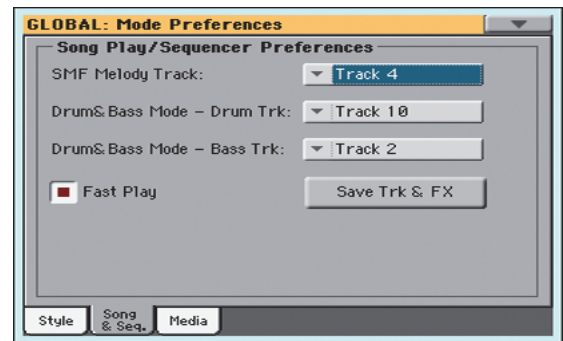

SMF Melody Track

This parameter lets you select the Song's Melody track for Standard MIDI Files. This track can then be muted by using the "Song Melody - Mute" function, assignable to an Assignable Switch or Footswitch.

Drum & Bass Mode - Drum

This parameter lets you select the Song's Drum track. This track is left set to play (together with the Bass track) when selecting the "Drum&Bass" function, assignable to an Assignable Switch or Footswitch.

Drum & Bass Mode - Bass

This parameter selects the Song's Bass track. This track is left set to play (together with the Drum track) when selecting the "Drum&Bass" function, assignable to an Assignable Switch or Footswitch.

Fast Play

When checked, this function allows to skip any empty setup beats at the beginning of a Standard MIDI File, and immediately start from the first note. While the beats are skipped, setup data they may contain are read and considered.

Please note that, being audio data, any empty space at the beginning of an MP3 file cannot be skipped.

Note: When Pa900 is driving an external musical instrument, the fast transfer of MIDI data to the MIDI OUT or USB port may cause a delay to the Song's start. Therefore, we suggest to turn this function off when Pa900 is hooked to other instruments.

Save Trk & FX

Touch this button to save the global parameters for the Song Play mode.

When touching this button, you are saving the following parameters:

- Play/Mute status of the Song tracks
- Default effect settings
- EQ settings for the Song tracks
- Internal/External status of the Song tracks

Mode Preferences: Media

This page includes various settings for the Media mode.

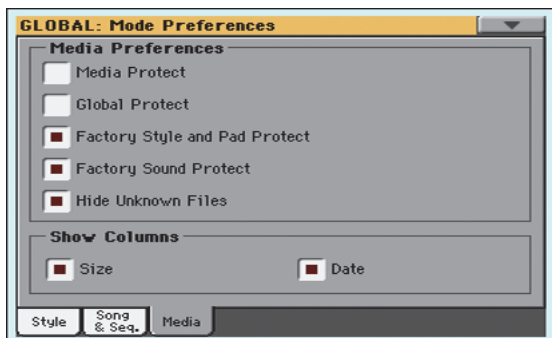

Media Preferences

Media Protect

When on, this parameter protects the internal “KORG [KORG DISK]” disk unit from writing.

Global Protect

When on, this parameter protects the global parameters from changes when loading data from disk.

Note: Global data from other Pa-Series models are not loaded even without protection.

Factory Style and Pad Protect

When On, this parameter protects the Factory Styles and Factory Pads (named “Hit”, “Sequence” and “Local” in the Pad Select window) from being overwritten when loading data from a device. Furthermore, you can't access these banks when saving data.

Also, when this option is checked, you cannot write any STS (Single Touch Setting) or Style Settings onto the Factory Styles. The “Write Single Touch Setting” and “Write Current Style Settings” command in the page menu are greyed out and cannot be selected. All original settings of the Factory Styles will be left untouched.

When Off, you can load or save User Styles or Pads into the Factory Style banks and Factory Pad banks. This way, you can customize your Factory Style and Pad banks. A Save All procedure also saves the Favorite and User Style, and the User Pad banks.

Note: This parameter is automatically set to On when the instrument enters standby.

Note: Should you accidentally delete some Factory Data, reload the Backup data or use the Factory Restore procedure (Media > Utility).

Factory Sound Protect

When On, this parameter prevents writing edited Sounds from the Sound mode into the Factory locations (Factory, Legacy, GM banks). When Off, you can freely save edited Sounds either in the Factory or User Sound area.

Warning: Use this feature with great care! Reorganizing the Factory Sounds may make both Styles and Standard MIDI Files play with the wrong Sounds!

Note: This parameter is automatically set to On when the instrument enters standby.

Note: Should you accidentally delete some Factory Data, reload the Backup data or use the Factory Restore procedure (Media > Utility).

Hide Unknown Files

When this option is checked, non-proprietary files are hidden when using Media operations, therefore making browsing directories easier.

Show Columns

Size

When checked, the Size column is shown in the File Selector when using Media operations.

Date

When checked, the Date column is shown in the File Selector when using Media operations.

Controllers: Hand Controllers

In this page you can program those controls you can operate with your hands.

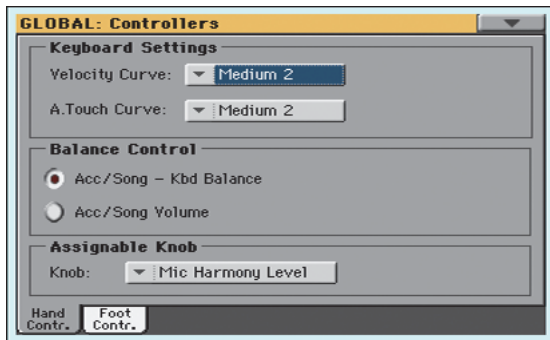

Keyboard Settings

Velocity Curve

This parameter sets the sensitivity of the keyboard to your touch.

Fixed No dynamic control available. Dynamic values are fixed, as in classic organs. When this option is chosen, you can set the fixed velocity value:

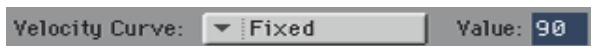

Soft1 ... Hard3

Curves, from the lightest one to the hardest one.

Balance Control

Balance Slider

The BALANCE knob can either be used to mix between the Keyboard and Accompaniment/Song tracks, or to control the Accompaniment/Song Volume without changing the Keyboard tracks. This is always a relative control, whose effective maximum value is determined by the MASTER VOLUME slider position.

Note: The BALANCE knob only works in the Style Play and Song Play modes.

Acc/Song - Kbd Balance

While in Style Play and Song Play mode, the BALANCE knob balances the volume of the Keyboard (Kbd) tracks against the Style (Accompaniment), Song and Pad tracks.

Acc/Song Volume

While in Style Play and Song Play mode, the BALANCE knob controls the volume of the Style (Accompaniment), Song and Pad tracks.

Controllers: Foot Controllers

This page lets you select a function to the Assignable Pedal/Footswitch, and select the polarity for the Damper and Assignable Pedal/Footswitch.

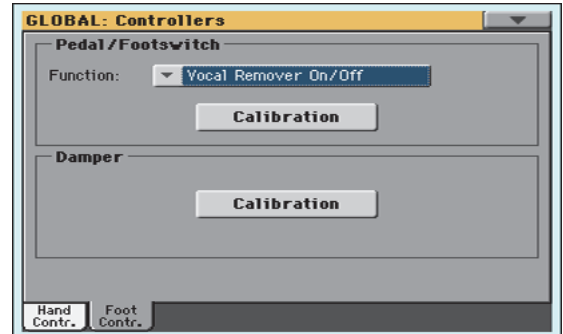

The following (optional) Korg pedals are compatible with Pa900:

Type	Model
Continuous (Volume/Expression)	EXP-2, XVP-10
Switch	PS-1, PS-3
Damper	DS-1H (supporting half-pedalling)

Pedal/Footswitch

Function

Function assigned to a continuous (i.e., volume/expression) pedal, or to a footswitch, connected to the ASSIGNABLE PEDAL connector. See page 354 for a list of the assignable functions. The first functions are switch-type functions, while the remaining (starting from Master Volume) are continuous-like functions.

Calibration

Use this button to calibrate and choose the polarity of the pedal/footswitch.

1. Connect the pedal or footswitch to the ASSIGNABLE PEDAL connector on the back of the instrument.
2. Go to this page, and touch the "Calibration" button in the display. The following dialog box appears:

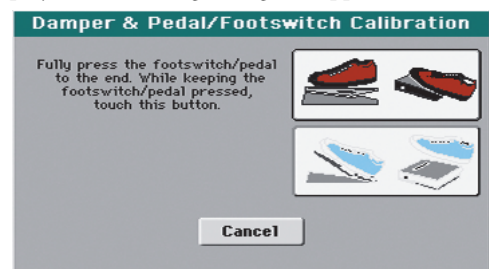

3. You are asked to set the pedal to the maximum value. Press the footswitch, or press the pedal to the maximum position (usually front pressed).

4. Touch the “Push” button in the display to confirm the maximum value. The following dialog box appears:



5. You are now asked to set the pedal to the minimum value. Release the footswitch, or press the pedal to the minimum position (usually back pressed).
6. Touch the “Push” button in the display to confirm the minimum value.
7. Check if the pedal or footswitch is working properly, and assign it a function.

Note: After loading a new Operating System, an older Global file, a “SET” folder containing a Global file, or a Backup file, you might need to re-calibrate the pedal/footswitch.

Damper

Calibration

Use this button to calibrate the action of the Damper pedal, and set its polarity. See above for details about the procedure.

Tuning: Basic

This is the general tuning of the instrument.

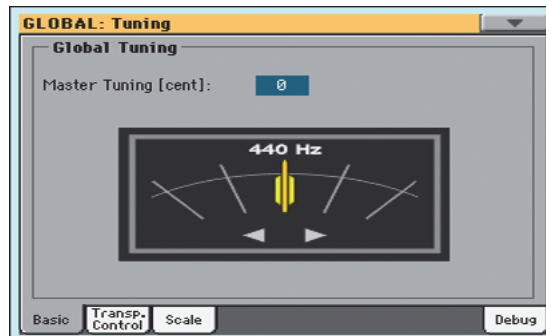

Global Tuning

Master Tuning

This is the master tuning of the instrument (in cents of a semitone). Use it to adapt your keyboard tuning to an acoustic instrument, for example an acoustic piano.

-100	Lowest pitch (half-semitone down).
0	Standard pitch (A4=440Hz).
+100	Highest pitch (half-semitone up).

Tuning: Transpose Control

This page is where you can select to which tracks the Master Transpose is applied to, and adjust some related parameter.

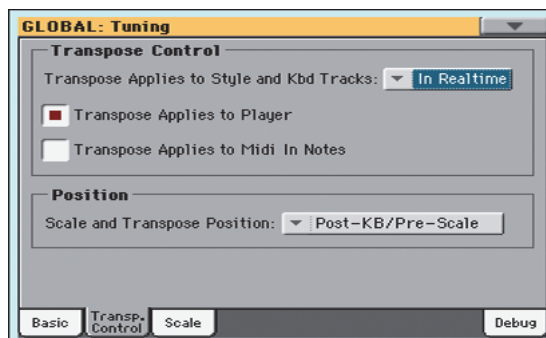

Transpose Control

Transpose applies to Style and Kbd tracks

Use this parameter to turn the Master Transpose on or off, and define the way it is applied, to Style and Keyboard tracks.

- | | |
|---------|---|
| Off | No Master Transpose is applied to Style and Keyboard tracks. Chords shown in the Lyrics page are, however, transposed. |
| In Sync | When you press either the TRANSPOSE [♭] or [#] buttons, the new transpose setting will not take effect until the first beat of the next measure is reached. |

In Realtime When you press either the TRANSPOSE [\flat] or [\sharp] buttons, the new transpose setting will occur when the next note is played for both the Style and Keyboard tracks individually.

The next key or chord you press will sound with the new transpose setting applied. (Note that if you play a Keyboard track prior to a new chord, the Keyboard track will play in the new key as the Style will continue to play in the old key until a new chord is entered).

Transpose applies to Player

This checkbox lets you turn the Master Transpose on or off for the onboard Player.

Transpose applies to Midi In notes

This checkbox lets you turn the Master Transpose on or off for Note messages received from MIDI IN.

Position

Scale and Transpose position

The Scale and Transpose Position allows you to define the relation between the Scale and the Master Transpose.

Post-KB/Pre-Scale

When this option is selected, notes will be transposed immediately after they leave the keyboard. The Scale will be applied to the transposed notes. For example, if you altered an E, and then set the Master Transpose to +1, the E key will play F, and the altered key will be E \flat (that will play an altered E).

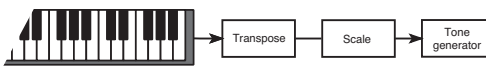

Post-KB & Scale

When this option is selected, all notes are transposed immediately before they enter the internal tone generator, or are sent to the MIDI OUT, but after the Scale. For example, if you altered an E, and set the Master Transpose to +1, the altered key will still be E (that will play an altered F).

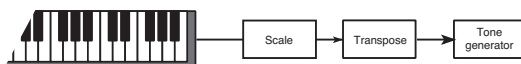

Standard MIDI File and chord transpose

When changing the Master Transpose, chord abbreviations contained in a Standard MIDI File are transposed and correctly shown in the display. Master Transpose must be activated on the Players, but not on the Keyboard.

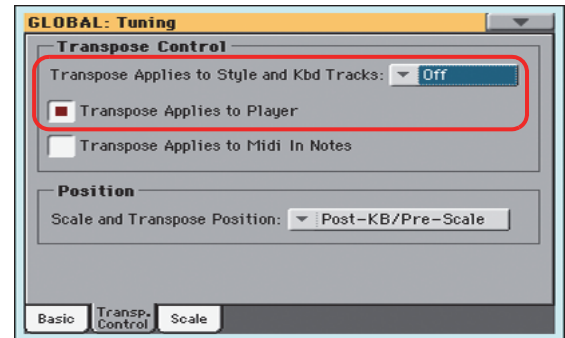

Note: Chords contained in a linked TXT file or shown when loading a CDG file are not transposed.

Drum Kits and transpose

Drum Kits are never transposed. If you want that any Sound is not transposed as well, assign them to a track set to the Drum mode in Style Play/Song Play > Track Control > Mode (see “Type” on page 120).

Tuning: Scale

This page lets you select the main scale of the instrument.

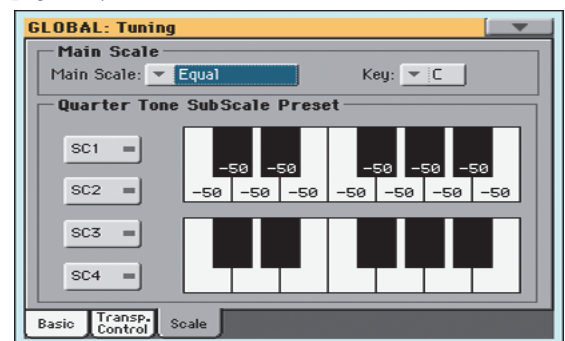

Main Scale

Main Scale

This parameter lets you set the main scale for the whole instrument, apart for those tracks where a different sub-scale has been selected by a Performance or STS (see “Scale” on page 117, Style Play mode).

See “Scales” on page 356 for a list of the available scales.

Note: You cannot select a User scale in Global mode.

Key

This parameter is needed by some scales to set the preferred key.

User Quarter Tone SubScale

This section is where you can program the Quarter Tone scale, and save up to four Quarter Tone Scale (SC) Presets.

SC Preset buttons

Touch these buttons to recall the corresponding presets. Each preset contains a custom detuning of each note of the scale (shown in the upper scale diagram). It also memorizes the selected degree(s) of the scale (shown in the lower scale diagram).

When no preset is selected, the default scale is automatically recalled. This scale assigns a -50 cent value to all notes, and turns all scale degrees off.

You can also select an SC Preset by assigning the relevant function to an Assignable Switch or Assignable Footswitch.

To save the current scale programming to a preset, while in this page choose the “Write Quarter Tone SC Preset” command from the page menu, then select one of the preset locations where to save the current settings (see “Write Quarter Tone SC Preset” on page 274).

Upper scale diagram

Use this diagram to set the detuning of each note of the scale.

-99...0...+99 Note detuning in cents. Zero is no detuning, ± 50 is a full quarter tone up or down, ± 99 is nearly one whole semitone up or down.

Lower scale diagram

Use this scale to turn detuning on or off. Applied detuning will depend on the programming set with the Upper scale diagram, or recalled by selecting one of the SC Presets.

When a note is detuned, a black dot appears in the corresponding note of the diagram.

MIDI: General Controls

This page allows you to select a MIDI Preset and set global parameters for the MIDI communication.

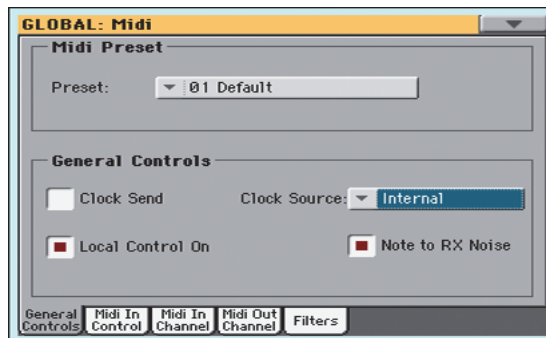

MIDI Preset

Preset

MIDI channels can be automatically configured by selecting a MIDI Preset. Each of them lets you automatically assign a value to various MIDI parameters, to allow an easier connection with a particular MIDI controller.

For detailed information about the preloaded MIDI Presets, see “MIDI Preset” on page 353.

After selecting a MIDI Preset, you can apply any changes to each channel’s settings. To store the changes in memory, select the “Write Midi Preset” command in the page menu to save it to memory (see “Write Midi Preset dialog box” on page 275).

Hint: You can restore the original MIDI Presets by using the “Factory Restore” command and choosing the “Global” option (page “Utility” of the Media mode, see page 291). Please consider this will reset all the Global data.

General Controls

Use these parameters to set MIDI Clock and Local Off.

Clock Send

Use this parameter to turn the clock information on the MIDI OUT or USB Device port on or off.

Note: This parameter is automatically set to On when the instrument enters standby.

- Off The Pa900 does not send the MIDI Clock signal. You cannot slave another instrument to the Pa900, even when connected to the MIDI OUT or USB Device port.
- On The Pa900 sends the MIDI Clock signal. You can slave another instrument to the Pa900 Tempo, Start/Stop and Play/Stop commands. Connect the other instrument to the Pa900 MIDI OUT or USB Device port.

Clock Source

This parameter selects the MIDI Clock source for the Style Play and Sequencer modes.

Note: In Song Play mode, the Internal clock is always used.

Note: This parameter is always set to "Internal" when the instrument enters standby.

Internal Internal, i.e. the clock generated by the Pa900 Arranger and Player internal metronome.

External MIDI External from the MIDI IN port. In Style Play or Sequencer mode, the Pa900 is slaved to an external device connected to its MIDI IN port. The Start/Stop and Play/Stop commands, as well as the metronome tempo, cannot be selected from the control panel of the Pa900. Use the external device to set the tempo and start or stop the sequencer or arranger.

External USB As the above, but referred to the USB Device port. See "Installing the Korg USB MIDI Driver" on page 428 for information on how to configure your computer for MIDI Over USB communication.

Local Control On

The Local parameter turns the keyboard on or off.

Note: This parameter is automatically set to On when the instrument enters standby.

On When you play the keyboard, MIDI data is sent to the internal sound generator. If tracks are assigned to a MIDI OUT channel, data is also sent to the MIDI OUT or USB Device port.

Off The keyboard is connected to the MIDI OUT or USB Device port, but cannot play the internal sound generator.

This is very useful when working with an external sequencer, to send notes and various MIDI messages from the integrated keyboard and controllers to the external sequencer, and then let the sequencer send them back to the sound generator, without overlapping. See the MIDI chapter.

Note to RX Noise

RX Noises are special sounds that allow Sounds to be more realistic. They are usually located above C7, depending on the Sound.

When this parameter is turned on, notes received from MIDI, or performed by the internal Player, in the RX Noises range, are recognized and converted to RX Noises. When off, notes are not recognized.

Note: This parameter is automatically turned on when the instrument is set to standby.

MIDI: MIDI In Controls

This page lets you program parameters for the MIDI IN and USB Device port, like the Chord Recognition channel. All these parameters can be saved into a MIDI Preset.

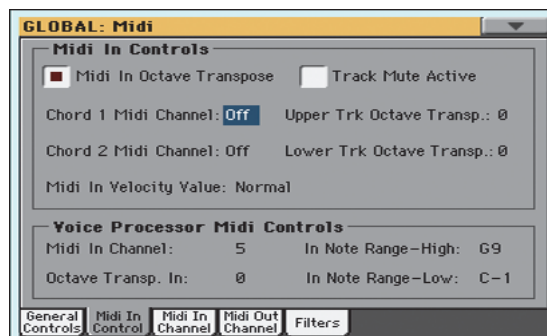

Midi In Controls

Midi In Octave Transpose

Use this parameter to determine if notes received on the MIDI IN or USB Device ports have to be transposed.

On Notes received on the MIDI IN or USB Device port are transposed according to the Octave Transpose setting for each track.

Off Data received on the MIDI IN or USB Device port are not transposed.

Track Mute Active

Use this parameter to determine if data received on the MIDI IN or USB Device port can be played by muted tracks.

On No data received on the MIDI IN or USB Device port can play on a muted track.

Off Data received on the MIDI IN or USB Device port can play on a muted track.

Chord 1 Midi Channel Chord 2 Midi Channel

Notes entering these channels on the MIDI IN or USB Device port, are sent to the Arranger.

There are two separate Chord channels. This is very useful when you have to send chords to Pa900 over two different channels (something very common on MIDI accordions).

Off Data received on the MIDI IN or USB Device port are not sent to the Arranger.

1...16 Data received on these channels via the MIDI IN or USB Device port are sent to the Arranger.

Upper Octave Transp (Transpose)

Octave transposition of data received on the MIDI IN or USB Device port for the Upper tracks. For example, if you select the +1 value, a C4 received via MIDI will play a C5 on the Pa900.

This parameter may be useful to many MIDI accordion players, whose MIDI interface may transmit on an unexpected octave.

-2...+2 Octave transpose value.

Lower Octave Transp (Transpose)

Octave transposition of data received on the MIDI IN or USB Device port for the Lower track. For example, if you select the +1 value, a C4 received via MIDI will play a C5 on the Pa900.

This parameter may be useful to many MIDI accordion players, whose MIDI interface may transmit on an unexpected octave.

-2...+2 Octave transpose value.

Midi In Velocity Value

Use this parameter to set a fixed velocity (dynamics) value for all received MIDI notes. This is useful when playing the Pa900 with an organ or a MIDI Accordion.

Normal Received velocity values are left unchanged.

40...127 All received velocity values are converted to the selected value.

Voice Processor Midi controls

Midi In Channel

Notes received on this channel are sent to the Harmony section of the Voice Processor.

Off No data is sent to the Voice Processor.

1...16 Data received on this channel via the MIDI IN or USB Device port is sent to the Voice Processor.

Octave Transpose In

Octave transpose for all notes received via MIDI by the Harmony section of the Voice Processor.

-2...+2 Octave transpose value.

In Note Range-High

This is the highest note that can be received by the Harmony section of the Voice Processor. Notes received over this note are not recognized.

B-1...G9 Highest note.

In Note Range-Low

This is the lowest note that can be received by the Harmony section of the Voice Processor. Notes received under this note are not recognized.

C-1...G#8 Highest note.

MIDI: MIDI In Channels

In this page, you can assign Pa900 tracks to any of the MIDI channels received on the MIDI IN and USB Device ports. All these parameters can be saved into a MIDI Preset.

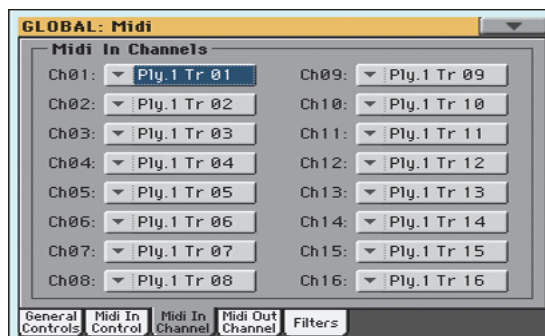

Channels

You can assign to each channel one of the following tracks:

Off No track assigned.

Lower Keyboard's Lower track.

Upper 1...3 One of the Keyboard's Upper tracks.

Pad 1...4 One of the Pad tracks.

Drum Style's Drum track.

Percussion Style's Percussion track.

Bass Style's Bass track.

Acc 1...5 One of the Style's Auto-accompaniment tracks.

Ply 1/2 Tr 01...16

One of the Players' tracks.

Global Special channel to simulate the Pa900's integrated controls (keyboard, pedals, joystick) with an external keyboard or controller. MIDI messages coming on this channel are seen as if they were generated by Pa900's integrated controllers.

Control On this special channel, the Pa900 receives MIDI messages to remotely select Styles, Performances, STS, Style Elements and SongBook Entries. See tables on page 430 and following for more information on the received data

MIDI: MIDI Out Channels

In this page, you can assign Pa900 tracks to any of the MIDI channels sent to the MIDI OUT and USB Device ports. All these parameters can be saved into a MIDI Preset.

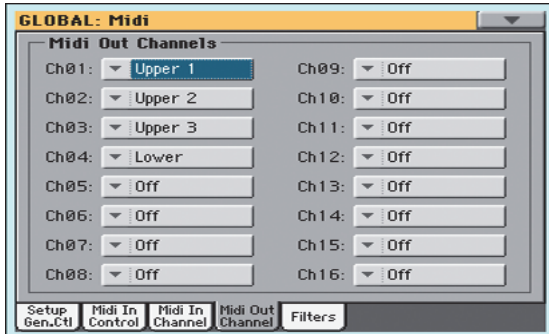

Channels

You can assign to each channel one of the following tracks:

Off	No track assigned.
Lower	Keyboard's Lower track.
Upper 1...3	One of the Keyboard's Upper tracks.
Pad 1...4	One of the Pad tracks.
Drum	Style's Drum track.
Percussion	Style's Percussion track.
Bass	Style's Bass track.
Acc 1...5	One of the Style's Auto-accompaniment tracks.
Ply 1/2 Tr 01...16	One of the Players' tracks.
Chord	Use this channel to send notes recognized by the Chord Recognition engine to the MIDI OUT and USB Device port. This is useful, for example, to control an external Harmonizer from the Pa900, using the Lower track to play chords, even if the track is muted.
Control	When this special channel is assigned to one of the MIDI OUT channels, MIDI messages are sent on this channel when choosing a SongBook Entry. The messages sent when selecting a SongBook Entry are the following: <ul style="list-style-type: none"> • An initialization strings, made of the NRPN Control Change messages #99 (MSB, with value 2) and #98 (LSB, with value 64) in fast succession. • A selection string, made of the two Control Change messages CC#06 (Data Entry MSB) for the thousands and hundreds, and CC#38 (Data Entry LSB) for the tens and units. The range of the Data Entry controls, in this case, is 0~99 (instead of the typical 0~127).

This type of data can be used by external editors to receive informations from the SongBook.

MIDI: Filters

Use this page to set up to 8 filters for the MIDI data received or sent by the Pa900 on the MIDI and USB Device ports. All these parameters can be saved into a MIDI Preset.

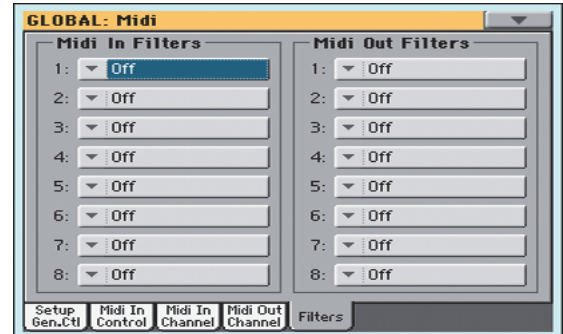

Midi In Filters

Selected MIDI IN filters. Filters are applied to all MIDI channels at the same time.

Off	No filter.
Pitch Bend	Pitch Bend.
MonoTouch	Mono (or Channel) After Touch.
PolyTouch	Poly After Touch.
PrgChange	Program Change.
SysExcl	System Exclusive.
All CC	All Control Change messages.
0...127	Control Change message #0...127. See "MIDI Data" on page 430 for a list of available Control Change messages.
Notes	Note events.

Midi Out Filters

Selected MIDI OUT filters. See above for information on each filter type.

Audio & Video: MP3 / Speakers

This page lets you define various parameters for the MP3 player and the speakers.

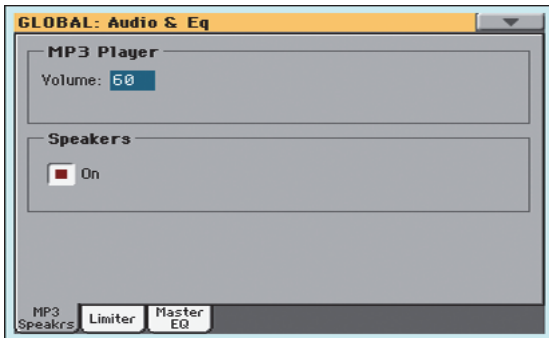

MP3 Player

Volume

Use this parameter to set the maximum volume for the MP3 Player. This control lets you balance MP3 files against SMF Songs and Styles.

0...100 Max volume in percentage.

Speakers

Speakers On/Off

Use this checkbox to turn the integrated speakers on or off.

Audio & Video: Limiter

The Limiter allows for an increased loudness of the MIDI tracks (Styles and Songs), by compressing the signal exceeding a defined threshold. MP3 files are not affected by the Limiter (since they are usually already “produced”, and do not need to pass through the Limiter again).

All these parameters can be saved into a Limiter Preset,

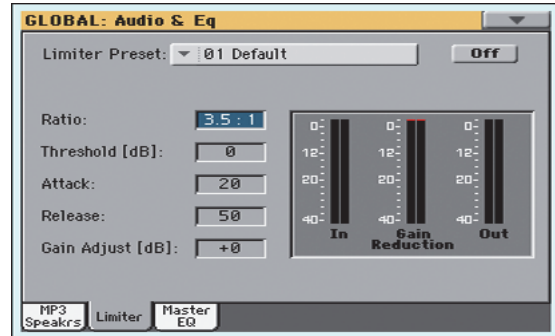

Limiter Preset

Use this pop-up menu to choose one of the available Limiter Presets, and automatically reconfigure the EQ parameters.

On/Off

This is the on/off switch for the Limiter section.

Ratio

Sets the signal compression ratio. Compression is applied only when the signal level exceeds the Threshold value. 1.0:1 means no compression.

Threshold

Sets the level above which compression is applied. 0dB means no signal processed.

Attack

Sets the attack time. A higher attack time will cause the compression to be applied more slowly, and not react fast enough for notes with faster transients.

Release

Sets the release time. A higher release time will cause the compression to be released more slowly; this may help sustaining longer notes.

Gain Adjust

Sets the output gain. Use it to compensate for the gain loss caused by compression.

Diagram

Use these indicators to check the level of the audio entering and coming out of the Limiter.

- If the input level is too high, decrease the level of the Sounds, Styles and/or Songs that are playing.
- If the output level is too high, decrease the level of the “Gain Adjust” control.

- Look at the gain reduction indicator, to understand the amount of limiting going on. Excessive limiting may dramatically change the quality of the musical program.

Audio & Video: Master EQ

In this page you can access the fully parametric Master EQ. This EQ is placed at the end of the audio path, just before the audio outputs. Both MIDI tracks (Styles and Songs) and MP3 files are equalized.

This is a full spectrum frequency equalization, positioned at the end of the signal chain, just before the Left & Right audio outputs. It gives you the power to design EQ curves and shape your sound. Master EQ features four fully programmable bands with fully adjustable gain, frequency, and Q parameters.

All these parameters can be saved into a Master EQ Preset.



EQ Preset

Use this pop-up menu to choose one of the available EQ Presets, and automatically reconfigure the EQ parameters.

On/Off

This is the on/off switch for the EQ section.

Diagram

Use these indicators to check the EQ curve, and the level of the audio entering and coming out of the Master EQ.

- If the input level is too high, decrease the level of the “Input Trim” parameter.

- If the output level is too high, decrease the level of the “Gain” controls.
- Keep in mind that boosting the Gain is not always the best way of making your sound appear louder; cutting the Gain of some band may make the other bands appear louder.

Input Trim

Use this knob to adjust the level of the signal entering the EQ. Excessive amount of signal may cause distortion when boosting the EQ bands.

Q

‘Quality’ of the EQ filter; higher values correspond to narrower, more accurate filters. Use higher values for near-surgical correction on isolated frequencies, lower values for more musical, softer equalization.

Band	Value
All Bands	0.5...10

Freq

Center frequency of the corresponding band. Center it on the problematic frequency, or the harmonics you want to emphasize or attenuate.

Band	Value
Low	20Hz...1kHz
Mid-Low	50Hz...10kHz
Mid-High	300Hz...10kHz
High	500Hz...20kHz

Gain

Gain of the corresponding band. Use it to make the frequencies stronger or weaker.

Band	Value
All Bands	-18...0...+18dB

Audio & Video: Video Out

Use this page to adjust the Video Out parameters.

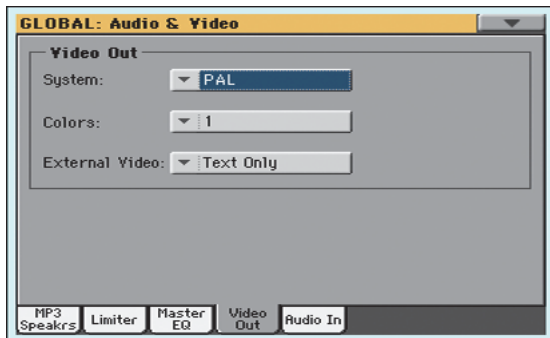

System

Selects the video standard (PAL or NTSC).

PAL Used in most European, South American, Asian and African Countries. This setting can be used also with SECAM TV sets (used in France, Russia, and some Countries of Africa); in this latter case, however, the picture is shown in black & white.

NTSC Used in North America, Central America and part of South America. It is also used in Japan, Korea, Taiwan, Philippines and Burma.

Colors

Selects a color set for the lyrics and background.

1...5 Color set. Try them to find the one you feel most comfortable with.

External Video

Reset to Text Only at startup. Use this parameter to decide what to show in the monitor connected to the Video Out port.

Text Only Only Lyrics and Chords (if any) are shown in the external display.

Mirror The internal display of the Pa900 is duplicated (“mirrored”) to the external display.

Audio & Video: Audio In

This page lets you route the Audio Inputs to the Voice Processor and/or the audio outputs.

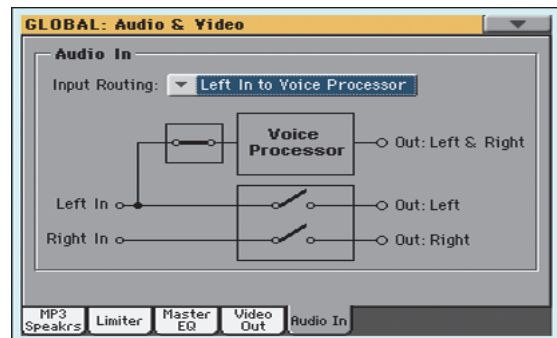

Microphone (Left In) to Voice Processor

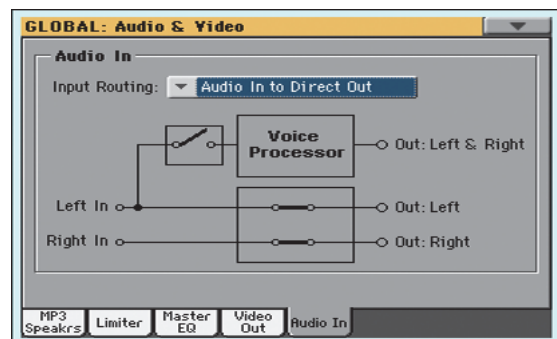

Microphone off, L-R Line In

Input Routing

Use this pop-up menu to choose the routing of the Audio Input signals.

Left In to Voice Processor

The **Left** audio input goes to the Voice Processor, then to the audio outputs. The **Right** audio signal is replicated on both Audio Outs. Both inputs are recorded when recording an MP3 Song.

Audio Ins to Direct Out

The **Left and Right** audio inputs go to the final mix, together with the sounds generated by the Pa900. No Voice Processor effect is applied.

Mic: Preset

The Voice Processor applies effects and three-part harmony to your voice. The dedicated controllers in the MIC SETTING section on the control panel allows you to quickly access the most often used functions.

In addition, in these pages you can edit the various effects and harmony styles, and save them into a Voice Processor Preset (VP Preset). With the latest two pages, you can edit the general settings for the singer's voice.

This page allows you to select a VP Preset, as well as turning on or off the various Voice Processor modules.



Preset

Current Voice Processor Preset

Use this parameter to select a Voice Processor Preset. A VP Preset is the programming of all Voice Processor's harmony and effect parameters. The Current Voice Processor Preset is the VP Preset that is currently selected and can be edited.

A VP Preset can be recalled by a Style, a Performance, a Song-Book Entry, or can be manually selected by pressing the PRESET button in the MIC SETTING on the control panel. This Preset is alternative to the Global VP Preset (see "Global Voice Processor Preset" on page 269) that is used when no selection is saved in a Style, Performance or SongBook Entry.

If you wish to save your VP Preset settings, keep the PRESET button pressed for about one second, or select the "Write Voice Processor Preset" command from the page menu (see page 274). The saved Preset will appear in the list of the available Presets.

Harmony Voices On/Off

These are "switches" for the voices generated by the Harmony section.

V1...V3

These checkboxes allow turning each of the three Harmony Voices on or off.

This is the same as the "Voice On/Off" checkbox in the "Mic: Harmony Voices" page (see page 267).

Master On/Off

These are "switches" for the various Voice Processor sections.

Lead

This checkbox allows turning the Lead voice on or off. This is useful in creating Presets where you want to hear harmony voices only.

Harmony

This checkbox allows the enabling/disabling of the Harmony module.

Effects

This checkbox allows the enabling/disabling of the Voice Processor Effects module.

Mic: Harmony

In this page you can define general parameters for the Harmony module.

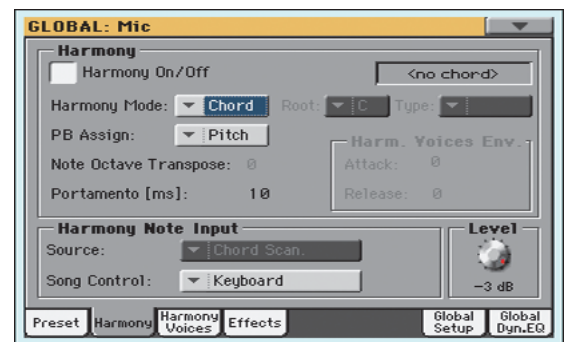

Harmony

Harmony On/Off

This checkbox allows enabling/disabling of the Harmony module. It is the same control found in the "Preset" page.

Harmony Mode

This parameter changes the Preset's harmony mode. The available options are: Scalic, Chord, Shift, and Notes. See "Harmony and Tuning with the Voice Processor" on page 270 for a full description of each harmony mode.

Root

(Only available in Scalic mode). In Scalic presets this sets the scale root.

Type

In Scalic presets this sets the scale type. If the selected type is Custom, a Custom Map can be used (see "Custom Voice Mapping" on page 267).

PB Assign

Pitch Bend control assignment. Allows assignment of the pitch bend to Pitch (applicable in Notes and Chord harmony modes).

Note: For this to work, a value other than zero must be assigned to the “Pitch Bend Range” in the “Mic: Global Setup” page (see page 269).

Note Octave Transpose

This transposes the harmony voices in Notes mode; the value corresponds to octaves (± 4). When receiving notes from MIDI, this value is summed to the value of the “Octave Transpose In” parameter, found in the “MIDI: MIDI In Controls” page (see page 259).

This is useful when used in conjunction with the “In Note Range-High” and “In Note Range-Low” parameters, also found in the “MIDI: MIDI In Controls” page, that limit the note input to a particular range, that could result too low or too high for the harmony notes (see page 260).

Portamento

This is defined in milliseconds as the time to reach a target note when a harmony voice needs to change pitch.

Harmony Voices Envelope

The envelope lets you set a different Attack and Release time for the harmony voices.

Note: The envelope can only work in Notes mode.

Attack

Sets the envelope attack time for harmony voices. Available only in Notes mode.

Release

Sets the envelope release time for harmony voices. Available only in Notes mode.

Harmony Note Input

When the Harmony Mode is Chord, harmony notes are always received from the Chord Scanning area.

When the Harmony Mode is set to Notes, harmony notes can be received from a source different than the Chord Scanning area. This way, you can continue sending chords to the Arranger with your left hand, while, for example, sending notes to the Harmony module with your right hand.

Source

This is the harmony notes source for the Style Play mode. It is the harmony notes source for the Song Play mode, when the “Song Control” parameter is set to Keyboard.

Note: When the Harmony Mode is Chord, the Source is always the Chord Scanning area.

Hint: To continue playing harmony notes on the keyboard when switching between Style Play and Song Play modes, set Source = Chord Scan, Song Control = Keyboard.

Chord Scan	Notes are received from the same chord scanning area dedicated to the Arranger. For example, if the Lower chord scanning mode is selected on the control panel, harmony notes are received from the Lower area of the keyboard.
Lower	Notes are received from the Lower area of the keyboard.
Upper	Notes are received from the Upper area of the keyboard.
Full Keyb.	Notes are received from the full range of the keyboard.

Song Control

This is the harmony notes source for the Song Play mode.

Off	Notes are not received when in Song Play mode.
Ply 1+2 Track [n]	Notes are received from the selected track from either Player.
Keyboard	Notes are received from the Keyboard. The range is the one defined by the “Source” parameter (see above).

Level

Level knob

Sets the overall harmony voices level.

Mic: Harmony Voices

The Voice Processor can add up to three Harmony Voices to the Lead voice. Here you can adjust parameters for each individual voice.



Voice Select buttons

V1...V3

Use these buttons to select one of the three available voices for editing.

Individual Voice Basic

Voice On/Off

This checkbox allows enabling/disabling of the selected Harmony Voice. It is the same control found on the “Preset” page.

Gender

This parameter sets the formant of the Harmony Voice. Use it to alter the character of the voice ranging from -50 (a big person with a deep voice) to 0 (no change) to +50 (mice/alien sound).

Voicing

This parameter is used to set the voicing of the selected voice. This parameter means different things depending on the harmony mode of the preset.

Scalic Mode Presets

In this mode the Voicing parameter specifies the interval of the harmony note with respect to the input note in the scale. The range of values goes from --8, which is 2 octaves below the input note, to ++8 which is two octaves above the input note. For example, a setting of +3 will result in a harmony voice a third above the input voice, related to the current scale.

Chord Mode Presets

In this mode the Voicing parameter specifies the relation of the harmony note to the input note with respect to the current chord. In Chord mode presets, the harmony voices are always notes in the chord. A setting of Up1 will result in the harmony voice being the next note above the input voice in the chord. For instance, if the chord was C Major and the input note was an E, an Up1 setting would produce a G harmony voice, just above the input E.

The range of values goes from Down 5 to Unison to Up6. Additional values are Root1 and Root2 which give the root of the recognized chord as the harmony voice, and Bass1 and Bass2 (bass

voicing) which give the lowest note received. Root2 and Bass2 are the higher pitch Root and Bass settings.

Shift Mode Presets

In this mode the voices are shifted relative to the input note. The values range from -24 semitones to +24 semitones.

Notes Mode Presets

In this mode there is no selectable voicing, since harmony voices exactly play received notes.

Smooth

Sets how much of the input pitch nuance is applied to the output voice.

Pan/Level

Level knob

Sets the output level of the selected voice. Please note that there is also a master harmony voice level found in the “Harmony” page.

Pan knob

Adjusts the pan for the selected voice. L64 (panned fully left) to R63 (panned fully right).

Custom Voice Mapping

This area is only available in Scalic Mode, when Type is Custom (see “Mic: Harmony” on page 265).

Scale mode harmonies are basically pitch maps. For each input note in a scale you can define a resulting harmony note. The Voice Processor has pre-defined pitch maps for all the offered scale roots, types, and intervals.

The Custom voicing feature allows you to create your own pitch maps. For example, you could define a pitch map so that a C input produces an E output and a D input produces an A output. The best way to work with custom voicing is as follows:

- For a given harmony voice, select the scale root, type, and interval that most closely matches the desired voicing.
- Go to the “Note In” parameter and select the input note that requires a different harmony note.
- Go to the “Note Out” parameter and change the harmony note as desired.
- Select various other input notes and remap as desired. Repeat the above steps for each harmony voice. You can also copy a map from a voice to other voices.
- The custom map can be transposed under the Harmony page by changing the “Root” parameter.

Note In

Incoming note.

C ... B Original note.

Note Out

Resulting note when applying the custom map.

±24 Number of semitones above or under the received note.

- UNI** Unison. The same note received on the input is sent to the output.
- NC** No Change. The harmony voice will keep its previous pitch until the lead voice pitch changes to a non “NC” note.

Copy to... button

Use this button to copy the current custom map to other voices. When you touch the button, the Copy Custom Voice Mapping dialog box appears:

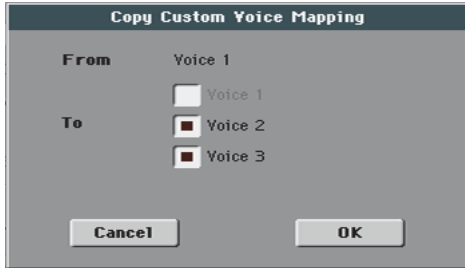

Check all desired target voices, then touch OK to confirm the copy.

Mic: Effects

This page allows to adjust the various effect parameters for the Voice Processor.



FX Mix

Lead to Delay knob

Lead to Delay effects send.

Harmony to Delay knob

Harmony to Delay effects send.

Reverb Level knob

Sets the overall volume of the Reverb effect.

FX Level knob

Sets the overall volume of the Delay effect.

Delay

Type

Use this parameter to select a Delay type.

- Mono** Mono delay.
- Stereo** Maintains the panning of the sends.
- PingPong1** Sends the lead voice to the left effect end only.
- PingPong2** Sends the lead voice to the sends depending on the lead pan setting.

Delay

Only available when Src = Manual (see below). Use this parameter to fine adjust (in milliseconds) the current delay time.

Feedback

Delay feedback amount.

Src (Source)

Use this parameter to set the source of the tempo for the delay.

- MIDI** Tempo is received from MIDI.
- Manual** The delay time is set using the “Delay” parameter.

R (Ratio)

Sets the ratio between the tempo and the resulting delay. For example, “1:2” means that for each quarter note at the current tempo, the delay plays two notes. A value of “1:4” means that for each quarter note at the current tempo, the delay plays four notes, and so on.

Hi Freq Damp (High Frequency Damping)

High Frequency Damping.

Reverb

Type

The list of reverb types includes the following acoustic simulations.

Hall	Smooth Hall
Wet Plate	Dry Plate
Room	Bright Room
Early Reflections	

Pre Delay

Reverb Pre-delay time. Sets the delay time prior to the reverb output. Large rooms typically have reverbs that start much later than the initial signal.

Reverb Time

Reverb Decay Time. Length of the Reverb.

Pre LEQ Gain

Reverb pre-equalization of the low frequencies. Specifies the characteristics of the reverbs low frequencies.

Pre HEQ Gain

Reverb pre-equalization of the high frequencies. Specifies the characteristics of the reverbs high frequencies.

Mic: Global Setup

In this page you can select a Voice Processor Preset, and set some general parameters for your voice. These parameters are general setting, that will not change when a different Preset is selected.



Setup

Global Voice Processor Preset

This VP Preset will be chosen when selecting a Performance or STS making use of the global VP Preset, instead of a “local” one. The use of a global VP Preset is shown in the Mic panel of the main screen.

Lead Setting

Low Cut Frequency

A low-cut filter can be activated on the Lead Voice. This filter allows for a cleaner signal from the microphone, by “cutting out” pops, room rumble and mic handling noise.

Off No low-cut filter applied.

60, 80, 120Hz Filter set to different frequencies. The frequencies below the set value are cut out.

Pan/Volume

Pan knob

Adjusts panning for the Lead voice. L64 (panned fully left) to R63 (panned fully right).

Level knob

This parameter sets the Lead voice level.

Off Lead voice is turned off.

-30dB ... 0dB Lead voice level.

Harmony Settings

Pitch Bend Range

Sets the range (in semitones) that pitch bend will alter the pitch of the harmonies in Notes mode.

Talk

The Talk function can be used when having to address the audience, speaking over the background music.

Mic Talk button

On/off switch for the Talk function. This is the same switch you can find in the Mic panel of the Style Play and Song Play modes.

This parameter is automatically set to off when turning the instrument on.

Note: When you deactivate the Talk function, the Voice Processor Preset is recalled. Any unsaved change to the Preset will be lost.

Auto (AutoTalk)

When this parameter is checked, the Talk function automatically engages when the Player or Arranger is stopped. This way, you can talk to the audience between two songs, without the need to touch the Mic Talk button.

Master Volume Attenuation knob

Use this knob to set the volume level reduction of the background music when the Talk function is engaged. 0dB corresponds to no level reduction.

Mic: Global Dynamics / EQ

In this page you can adjust parameters for the Compressor/Gate and Equalizer, applied to the Lead and Harmony voices.

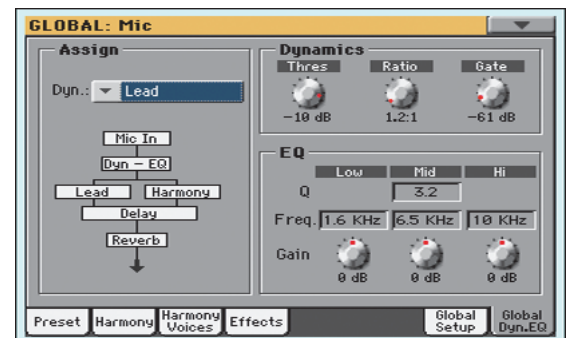

Assign

Dyn

Compressor/Gate assignment. The options are Off, Lead + Harmony, Harmony or Lead. The compressor has auto-makeup gain, so there are no output levels problems when selecting a different option.

Dynamics

The Voice Processor has dynamics processing optimized for vocals.

Threshold knob

Compressor Threshold. Range: 0 to -60 dB.

Ratio knob

Compression ratio. Range: 1.1:1 to 64:1.

Gate knob

Gate Threshold. Range: Off, -70dB to 0dB

EQ

The Voice Processor has an extremely flexible 3-band EQ with frequency and gain-adjustable high and low shelving bands, as well as a fully parametric band with Q control.

Low Frequency

Low Shelving Frequency center frequency. Range: 80Hz...16kHz.

Low Gain knob

Low Shelving Frequency cut/boost. Range: ±12 dB.

Mid Q knob

Resonance of the midband. Range is .1 (wide band) to 10 (very narrow band).

Mid Frequency

Mid Band Frequency center frequency. Range: 80Hz...16kHz.

Mid Gain knob

Mid Band Frequency cut/boost. Range: ±12 dB.

High Frequency

High Shelving Frequency center frequency. Range: 80Hz...16kHz.

High Gain knob

High Shelving Frequency cut/boost. Range: ±12 dB.

Harmony and Tuning with the Voice Processor

Harmony

Here's where we can go into a little more depth about harmonies. We've tried to keep it practical, focusing on what Voice Processor can do for you.

Harmony Modes

The Voice Processor has four different harmony modes, which give four unique methods of creating harmony. Once we get into describing the more complex harmony modes, we'll be showing you examples based on the C major scale. If you are unfamiliar with this scale we've shown C major here.

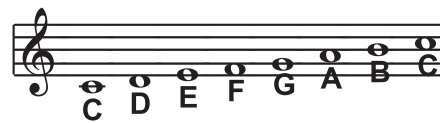

Notes Mode

In this mode, you provide the Voice Processor with specific note information to determine the pitch of the harmony voices. This is the most direct and flexible way of creating harmonies, allowing you to weave complex melodies and counter harmonies irrespective of your lead vocal.

Shift Mode

Also known as “Fixed Interval”, this takes the pitch of your lead voice and creates harmonies a set number of semitones away, based on that pitch. The method of creating harmonies, using a fixed number of semitones relative to an input note or pitch, is called chromatic harmony, the theory of which we'll go into later. We consider this type of harmonizing to be non-intelligent because Voice Processor is not set to any particular key or scale. These are pure, parallel harmonies. The most common shift harmony voices are the 5th (7 semitones) and octave (12 semitones), ranging from two octaves below the input to two octaves above the input pitch.

Below is the C Major scale, showing third above chromatic scale harmony, as used in Voice Processor Shift Mode.

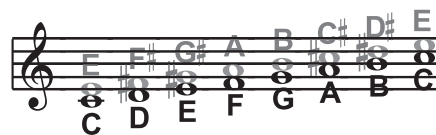

Black = Lead, Grey = Harmony

Chord (Chordal) Mode

Chordal harmonies take your chord information to create intelligent, diatonic harmonies based on your voice. To make Chordal harmonies, you need to input in real time the chords of the song. This may be done either by playing on the keyboard, via MIDI or through a programmed sequence of chords included in the Harmony Track of a Song.

In Chordal mode the Voice Processor will only create harmony voices that fall on the notes of the chord. Chordal harmonies are “intelligent” because they decipher the chord you’re playing and the note you’re singing to produce musically pleasing harmonies. When one note above is defined as a harmony voice (Up1), the next note from the chord above the input note is output for that harmony voice.

The subsequent illustration shows the harmony notes for the C major scale with a voicing selection of a C major chord and a single “one above”.

Root: C, Chord Type: Maj, Voicing: Up1

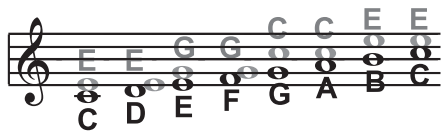

Black = Lead & Grey = Harmony

You might have noticed that each harmony note can cover more than one input note, or that each input note doesn’t necessarily have a unique harmony note. For instance, C and D both have E as the 3rd above, E and F share G, and so on. This gives a more stepped sound to the harmony as the changes are both greater in magnitude and less frequent than when using other harmony methods (shift mode for example). The benefit of this method is that it is very easy to integrate vocal harmonies into your songs if you already know their chord progressions! The following lists the chords available with respect to the root of “C”:

Major	C	E	G	
6	C	E	G	A
Maj7	C	E	G	B
M7sus4	C	F	G	B
min	C	E _b	G	
min6	C	E _b	G	A
min7	C	E _b	G	B _b
min7b5	C	E _b	G _b	B _b
dim	C	E _b	G _b	[B _{bb} (= A)]
7	C	E	G	B _b
7b5	C	E	G _b	B _b
aug	C	E	G _#	
aug7	C	E	G _#	B _b
sus4	C	F	G	
sus2	C	D	G	
7sus4	C	F	G	B _b

Scale (Scalic) mode

Harmonies use key and scale information to create musically correct, diatonic harmonies. Most popular music uses a single scale, so you usually only have to input the information at the beginning of your song. “Scalic” harmonies are more dynamic than the chordal harmonies because there are unique harmony notes for each input note. The subsequent illustration shows the harmony notes for the C major scale with a voicing selection of a C major scale and a single “third above” harmony voice. You can see from the next diagram that the “Scalic” harmonies are intelligent and closely follow your lead voice for a tighter sound.

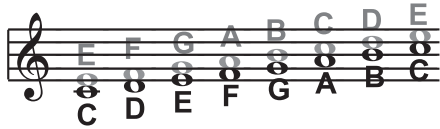

Black = Lead, Grey = Harmony

Under the Harmony page, is a parameter called “Smooth”. When set to 100% the harmony voices follow your input pitch, errors and all, but when set to 0% the harmonies will jump directly to the scalic harmony notes, kind of like a hard pitch correction on the harmony voice. Setting the Smooth parameter between 0 and 100% is like having variable amounts of pitch correction on the harmonies. Voice Processor has five preprogrammed harmony scales: three major, three minor and one custom per preset. To

create a custom scale or pitch map see the parameter description under “Custom Voice Mapping” on page 267.

It is also tricky to pick out the key in some songs. An example is “Sweet Home Alabama”. Listening, you might think this song is in the key of “D”, as that’s the first chord, but the harmonies actually work best in the key of “G” – try running the song through Voice Processor to hear for yourself.

Setting the scale can also take a bit of practice: for songs centered around the third or root of the scale it might not sound like there’s any noticeable differences between the three major or three minor scales. This is because your song doesn’t hit any of the scale’s altered notes. A melody centered around the fifth of the scale, (such as B in the key of E), highlights the differences between the scales. Try the “Sha Lala Lala ... La Tee Daa” chorus of Van Morrison’s “Brown Eyed Girl” (key: E, scale: major, 3rd above voicing) with each major scale to hear the audible difference between them. For the minor scales, Santana’s “Evil Ways” (key: G, scale: minor, 3rd above voicing) highlights the differences between the three minor scales.

The following table illustrates the third and fifth above for a given input note to illustrate the differences between the six different scales. “nc” means no change, in that the harmony voice will simply keep its previous pitch until the lead voice pitch changes to a non “nc” note.

	Lead Voice	C	C#	D	E _b	E	F	F#	G	G#	A	B _b	B
MAJ1	3rd above	E	nc	F	nc	G	A	nc	B	nc	C	D	D
	5th above	G	nc	A	nc	B	C	nc	D	nc	E	F	F
MAJ2	3rd above	E	nc	F	nc	G	A	nc	C	nc	C	D	D
	5th above	G	nc	A	nc	C	C	nc	E	nc	E	F	F
MAJ3	3rd above	E	nc	F	nc	G	A	nc	B _b	nc	C	D	D
	5th above	G	nc	A	nc	B _b	C	nc	D	nc	E	F	F
MIN1	3rd above	E _b	nc	F	G	nc	A _b	nc	B _b	C	nc	D	nc
	5th above	G	nc	B _b	B _b	nc	C	nc	D	E _b	nc	F	nc
MIN2	3rd above	E _b	nc	F	G	nc	A	nc	B _b	C	nc	D	nc
	5th above	G	nc	A	B _b	nc	C	nc	D	E _b	nc	F	nc
MIN3	3rd above	E _b	nc	F	G	nc	A _b	nc	B	C	nc	D	nc
	5th above	G	nc	A	B _b	nc	C	nc	D	E _b	nc	F	nc

Diatonic and Chromatic

We've described scalic and chordal harmonies as diatonic, and shift harmonies as chromatic; but what do those words mean? Look at a piano keyboard. Between middle "C" and the next "C" there are twelve keys – 7 white keys and 5 black keys. Each of those keys are pitched one semitone apart for a total of, you guessed it, 12 semitones. The chromatic scale uses all twelve semitone notes opposed to the diatonic scales. Thus there is only one chromatic scale, but 12 each of the major, minor, etc. diatonic scales (C major, C# major, D major, etc). Most of us have grown up hearing the traditional "doh ray me fah so la tee doh" diatonic scale, so that harmonies based on the diatonic scale sound correct.

What does this mean, harmony-wise? Diatonic scale harmonies can only use notes within specified scale or chord, so a "third above" harmony voice actually varies between three and four semitones above the lead note where the chromatic harmony would stay exactly four semitones (a major 3rd) above each note.

To recap: we have three different harmony modes that use chromatic or diatonic scales.

Shifting, which uses the chromatic, 12 semitone scale, changes the input pitch by a fixed number of semitones:

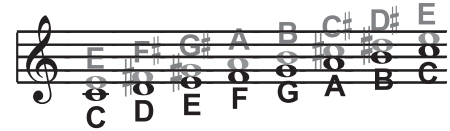

Chordal, which uses the root, third, fifth and sometimes seventh of the many diatonic scales, pitches the harmony voice to the closest note contained within the chord:

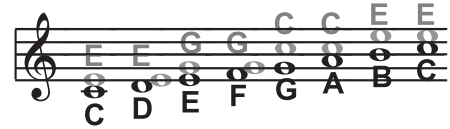

Scalic, which uses one of many diatonic scales, pitches the harmony voice to the nearest note contained within the scale:

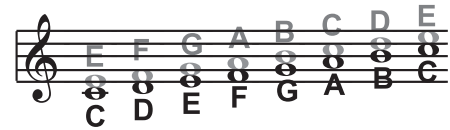

Theory aside, the best way to get great sound is to experiment with all of Voice Processor' possible harmony modes. Not only will you develop an intuitive sonic sense of what works best where, but by investigating different permutations and combinations you could discover some delightful sounds you might otherwise have missed.

Touch Panel Calibration

From time to time (for example, after loading a new operating system), calibrating your Color TouchView™ display may be necessary to make pointing more precise. If so, use this page.



1. When in this page, first touch exactly inside the set of arrows in the upper left corner of the display.
2. The arrows will subsequently move to the other corners of the display. Touch exactly inside them.
3. Finally, touch Save to confirm the new calibration.



- In case you want to exit and cancel the calibration, press EXIT before completing the procedure.

Hint: To quickly reach this page from any other page, keep the GLOBAL button pressed until this page appears.

Page menu

Touch the page menu icon to open the menu. Touch a command to select it. Touch anywhere in the display to close the menu without selecting a command.



Note: In each Global page, the only available Write Global options from the page menu are the ones relevant to the content of the current page. All other Write Global options are greyed out.

Write Quarter Tone SC Preset

Choose this command to open the Write SC Preset dialog box, and save the current scale settings in one of the four available SC Presets.

See “Write Quarter Tone SC Preset dialog box” on page 275 for more information.

Write Midi Preset

Select this command to open the Write Midi Preset dialog box, and save the current MIDI settings into one of the available MIDI Presets.

See “Write Midi Preset dialog box” on page 275 for more information.

Write Limiter Preset

Choose this command to save the Limiter settings to one of the available Limiter Presets.

See “Write Limiter Preset dialog box” on page 275 for more information.

Write Master EQ Preset

Choose this command to save the Master EQ settings to one of the available Master EQ Presets.

See “Write Limiter Preset dialog box” on page 275 for more information.

Write Voice Processor Preset

Choose this command to save the Voice Processor settings to one of the available Voice Processor Presets.

See “Write Voice Processor Preset dialog box” on page 276 for more information.

Write Quarter Tone SC Preset dialog box

Open this dialog box by selecting the Write Quarter Tone SC Preset item from the page menu. Here, you can save the current scale settings in one of the four available SC Presets.

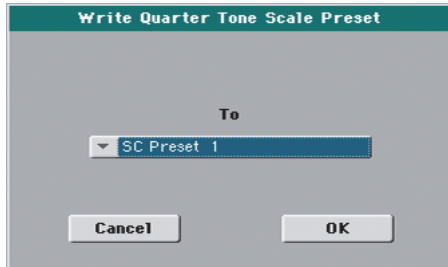

To

One of the four available SC Preset locations, where to save current scale settings.

Write Midi Preset dialog box

Open this dialog box by selecting the Write Midi Preset item from the page menu. Here, you can save all MIDI settings to a MIDI Preset.

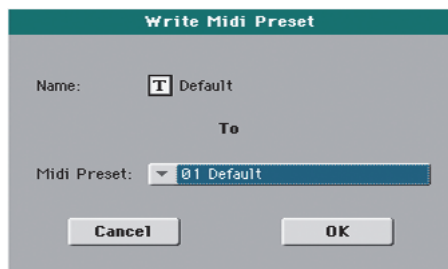

Name

Name of the MIDI Preset to be saved. Touch the **T** (Text Edit) button next to the name to open the Text Edit window and modify the name.

Midi Preset

One of the available MIDI Preset locations, where to save current MIDI settings.

Write Limiter Preset dialog box

Open this dialog box by selecting the Write Limiter Preset item from the page menu. Here, you can save current settings for the Limiter edit section (see starting from page 262).

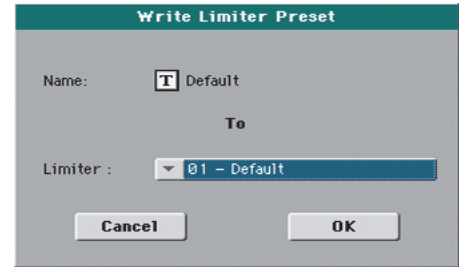

Name

Name of the Limiter Preset to be saved. Touch the **T** (Text Edit) button next to the name to open the Text Edit window and modify the name.

Limiter Preset

One of the available locations, where to save current Limiter settings.

Write Master EQ Preset dialog box

Open this dialog box by selecting the Write Master EQ Preset item from the page menu. Here, you can save current settings for the Master EQ edit section (see starting from page 263).



Name

Name of the Master EQ Preset to be saved. Touch the **T** (Text Edit) button next to the name to open the Text Edit window and modify the name.

Master EQ Preset

One of the available locations, where to save current Master EQ settings.

Write Voice Processor Preset dialog box

Open this dialog box by keeping the PRESET button in the MIC SETTING section pressed for about one second, or by selecting the Write Voice Processor Preset item from the page menu. Here, you can save current settings for the VP Preset in the Mic edit section (see starting from page 265).

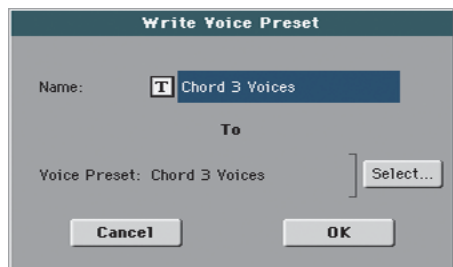

Name

Name of the VP Preset to be saved. Touch the **T** (Text Edit) button next to the name to open the Text Edit window and modify the name.

Voice Preset

One of the available locations, where to save the current VP Preset settings.

Media mode

The Media mode is where you can manage files. This mode overlaps the current operating mode (Style Play, Song Play, Sequencer, Sound).

Storage devices and internal memory

User-accessible storage devices

During a Media operation, files are usually exchanged between a storage device and the internal memory. You can access the following mass storage device types:

Name	Media type
DISK [KORG DISK]	User-accessible area of the internal memory. This is where you can store Songs and other files.
SD [KORG SD]	Optional microSD card inserted into the rear slot.
SD [KORG SD2]	Optional microSD card inserted into the rear slot (second partition).
USB	USB memory device (like a memory stick) connected to the rear USB Host port.

A device can be selected by using the Device pop-up menu, shown in the lower left corner of most Media pages:

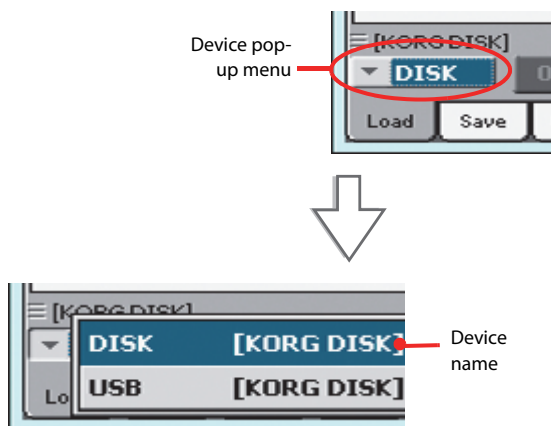

Supported device

Pa900 supports external devices, like hard disks or USB memory sticks, formatted in FAT16 or FAT32 with long file names. NTFS (Windows NT/2000/XP/Vista/7), HFS (Mac OS 9) and HFS+ (Mac OS X) formats are not supported.

Selecting and deselecting files

While a file list is shown in the display, you can select any item by touching it. The selected item is highlighted.

You can deselect all items in any of the following ways:

- Touch an empty area in the file list (if available).
- Touch the Device pop-up icon, and select the current device again.

Searching files

By using the Search function, you can search files and musical resources in all internal and external devices. For more information, see the relevant chapter.

Preferences

You can change some global preferences of the Media mode in the Global > Mode Preferences > Media page (see page 254).

File types

The following tables describe all the file and folder types the Pa900 can manage. Here are the files you can read or write with the Pa900.

Extension	File/folder type
SET	All the User data. (This is a folder containing other folders)
BKP	Backup file, created with the "Full Resource Backup" function of the Media > Utility page
GBL	Global Setup
VOC	Voice Processor Presets
QTP	Quarter Tone Scale Presets
MPR	MIDI Presets
AUD	Limiters and Master EQ Presets
PRF	Performance
PCG	Sound (Korg Pa-Series)
KMP	Multisample
PCM	Sample
AIF	AIFF audio files
WAV	WAVE audio files
STY	Style
PAD	Pad
SBD	SongBook
SBL	SongBook's Custom List
JBX	Jukebox
MID	Standard MIDI File, SMF
MP3	MP3 file
TXT	Plain text file

Pa900 can also read (but not write) the following types of data.

Extension	File type
PKG	Operating System and Musical Resource files
KAR	Karaoke file
CDG	CD+Graphics file
PCG	Korg Triton Programs
KSF	Korg Trinity/Triton Sample
SF2	SoundFont 2 Bank

Media structure

Each device (and the internal memory) can contain files and folders. Data in the Pa900 is slightly more rigidly structured than in a computer, due to the pre-configured type of data inside the instrument's memory. The diagram below shows the global structure of a Pa900 device.

Note: Factory Styles and Pads can be seen in Media mode only when the "Factory Style and Pad Protect" parameter is set to Off (see page 254), and only when loading or saving a single Style bank, or when erasing something.

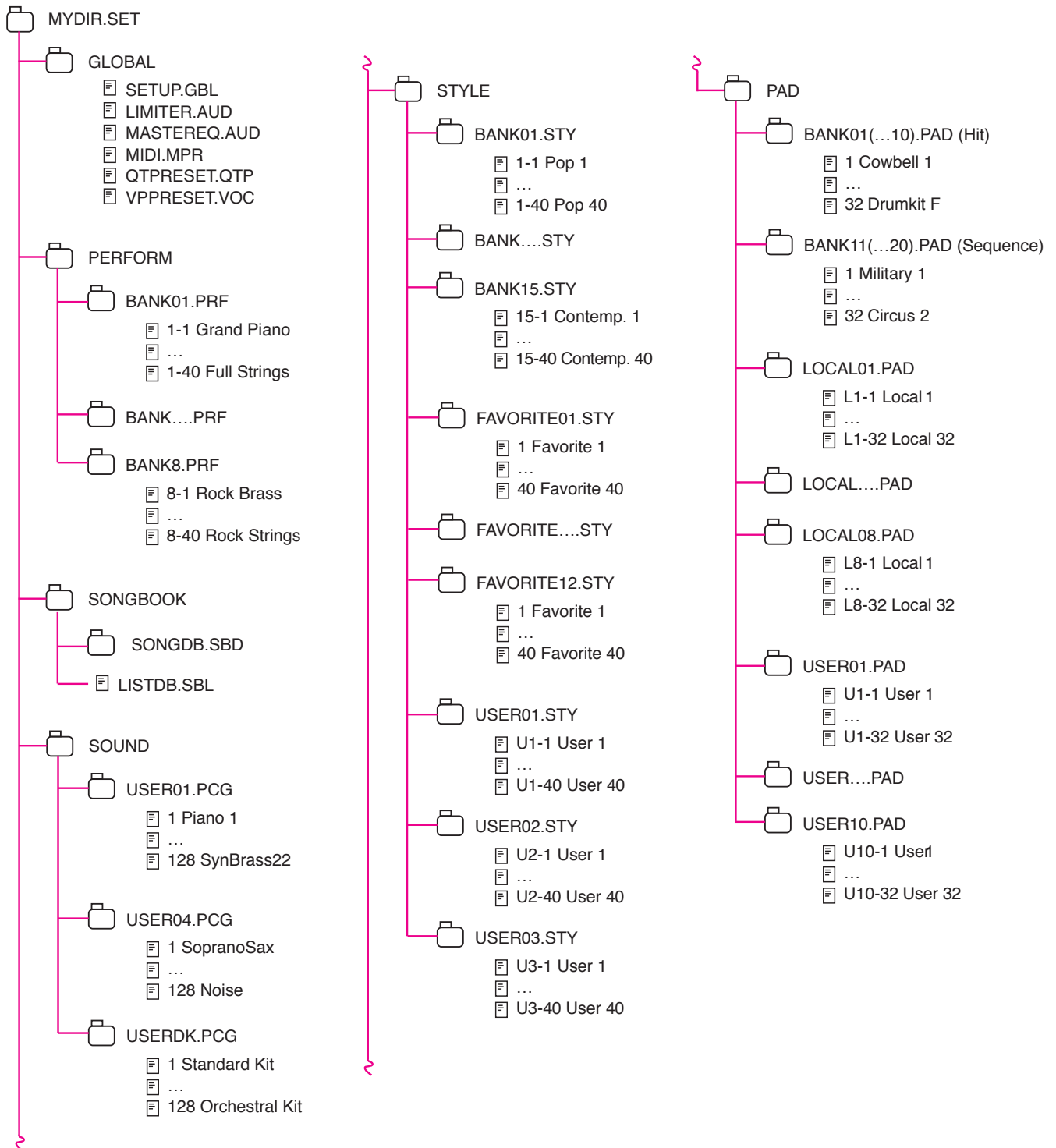

Main page

There is no main page in the Media mode. When pressing EXIT, you exit the Media mode, and the underlying operating mode in the background is recalled.

Page structure

All pages share some basic elements.

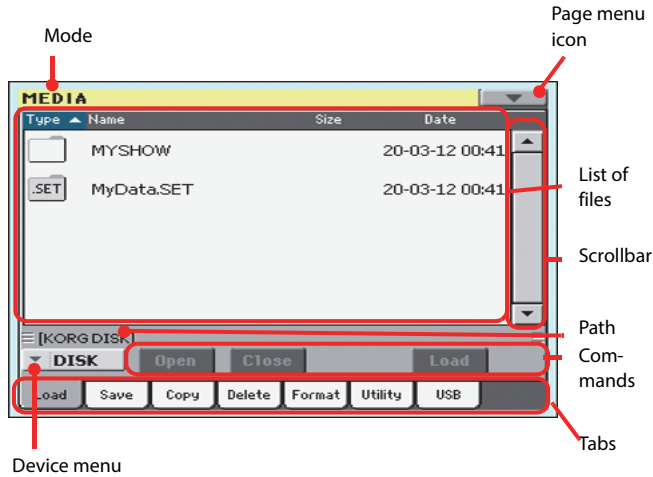

Mode

This indicates that the instrument is in Media mode.

Page menu icon

Touch this icon to open the page menu (see “Page menu” on page 293).

Path

Full path of the directory currently shown in the display.

List of files

This area shows the files and folder contained in the selected device.

You can touch one of the heading labels above the list to change the order in which files are shown. For example, by touching the “Name” label, the list is alphabetically re-ordered according to the file names. The selected label appears highlighted, showing the currently selected ordering.

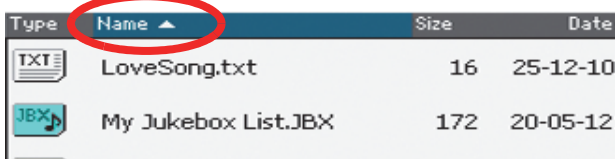

If you touch the highlighted label again, the alphabetic order changes from ascending to descending, or vice-versa. The small arrow next to the label name shows the selected order.

Scrollbar

Use the scrollbar to scroll the list. Touching the arrows will scroll one step at a time, while touching the bar will scroll one page at a time.

Touching the arrows while SHIFT is kept pressed jumps to the previous or next alphabetical section, or file/folder type (depending on the selected display order).

Device pop-up menu

Use this menu to select one of the available storage devices.

Commands

Commands may be different depending on the shown page. They are detailed in each relevant section.

Tabs

Use tabs to select one of the pages of the current section.

Navigation tools

When in a Media page, you can use any of the following commands to browse through the files and folders.

Scrollbar

See “Scrollbar” above.

VALUE DIAL

Use the VALUE DIAL to scroll the list up or down.

Device pop-up menu

See “Device pop-up menu” above.

Load/Save/Copy/Delete button

Executes the media operation.

Open button

Opens the selected folder or directory (whose name begins with the “” icon).

Close button

Closes the current folder or directory, returning to the parent (“upper”) level.

Load

In this page you can load User data files (Performances, User Sounds, User Styles, the SongBook, the Global) from an internal or external storage device to the internal memory.

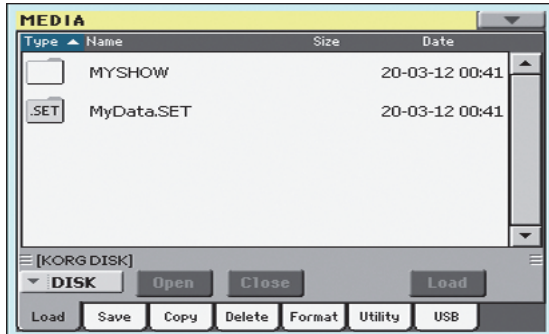

Note: While in this page, only data allowed for loading are shown. All other files are hidden.

Merging data

When loading all User data, or all data of a specified type, most data loaded from a storage device are merged with data already existing in memory. For example, if there is data in all three USER Style banks in memory (USER01, USER02, USER03), and there is only the USER01 Style bank in the storage device, the USER01 bank will be overwritten, while USER02 and USER03 banks will be left unchanged.

As a result, there will be a STYLE folder in memory containing the USER01 bank you just loaded, and the old USER02 and USER03 banks.

Loading all the User data

You can load all the User data with a single operation.

1. If loading from an external device, connect the device to the USB Host port.
2. Use the Device pop-up menu to select the source device. When the device is selected, its content will appear in the display.
3. If the folder you are looking for is inside another folder, select this latter and touch the Open button to open it. Touch the Close button to go back to the parent folder.
4. Select the ".SET" folder containing the data you wish to load, and touch Load to confirm the selection.

To create a new .SET folder with PCM samples from different sources, see "Merging Samples from various sources" on page 294.

Loading all data of a specified type

You can load all data of a specified type with a single operation.

1. If loading from an external device, connect the device to the USB Host port.
2. Use the Device pop-up menu to select the source device. When the device is selected, its content will appear in the display.
3. If the folder you are looking for is inside another folder, select the latter and touch the Open button to open it. Touch the Close button to go back to the parent folder.
4. Select the ".SET" folder containing the data you wish to load, and touch Open to open the ".SET" folder. A list of User data appears (Global, Performance, SongBook, Sounds, Style...).

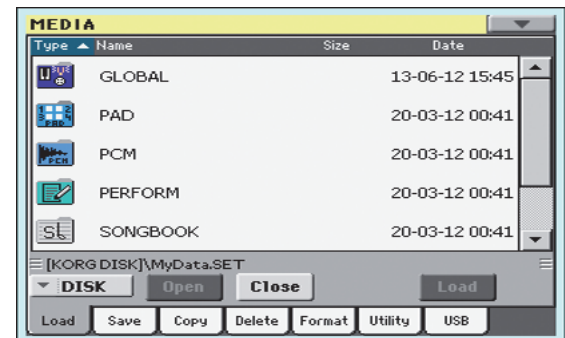

5. Select the folder containing the type of data you are looking for, and touch Load to confirm your selection.

Loading a single bank

You can load a single bank of data (Sounds, Styles, Performances) with a single operation. Each bank corresponds to each of the side tabs in the various Select windows (Style Select, Performance Select...).

1. If loading from an external device, connect the device to the USB Host port.
2. Use the Device pop-up menu to select the source device. When the device is selected, its content will appear in the display.
3. If the folder you are looking for is inside another folder, select this latter and touch the Open button to open it. Touch the Close button to go back to the parent folder.
4. Select the ".SET" folder containing the data you wish to load, and touch Open to open the ".SET" folder. A list of User data appears (Global, Performance, SongBook, Sounds, Style...).

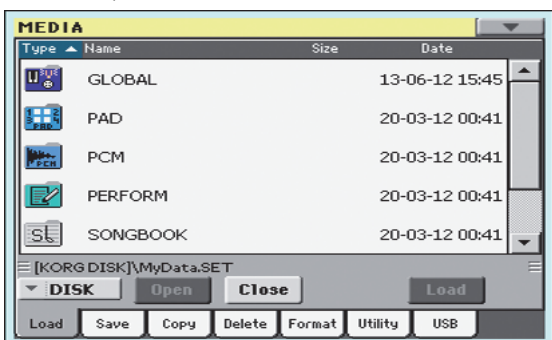

5. Select the folder containing the type of data you are looking for, and touch Open to open the selected folder. A list of Favorite/User banks appears.

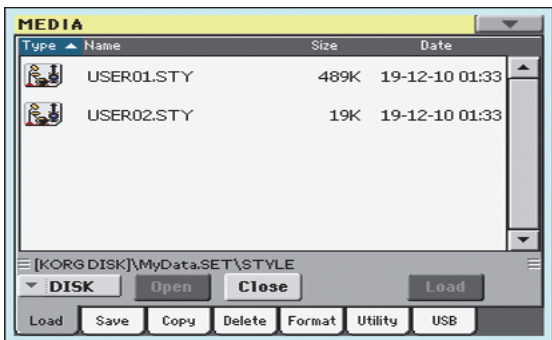

6. Select the bank file you are looking for, and touch Load to confirm the selection. A dialog box appears, asking you to select one of the available User (or Favorite/User Style) banks in memory.

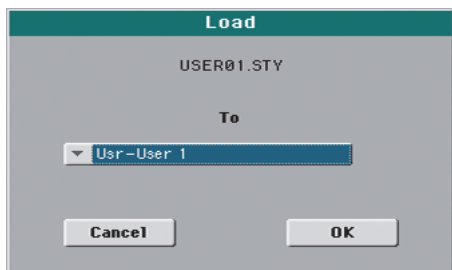

In the example above, the previously selected Style bank will be loaded into the bank USER 1 in memory. The Styles already existing in memory will be deleted and overwritten.

7. Select the target bank, and touch OK to load the source bank.

Warning: After confirming, all User data contained in memory are deleted.

Note: You can save space for loading new data by deleting all unused PCM Samples from memory. When Sounds or Drum Kits based on external PCM Samples are deleted, you no longer need the now unassigned PCM Samples. Use the "Not assigned to any Multisample/Drumkit" Delete option in the Sampling mode to delete all the unassigned Samples (see page 244).

Note: If you are loading a bank of Sounds, and one or more Sounds or Drum Kits use external PCM Samples, the Samples are automatically loaded (unless they are already in memory).

Loading a single item

You can load a single item with a single operation.

1. If loading from an external device, connect the device to the USB Host port.
2. Use the Device pop-up menu to select the source device. When the device is selected, its content will appear in the display.
3. If the folder you are looking for is inside another folder, select this latter and touch the Open button to open it. Touch the Close button to go back to the parent folder.
4. Select the ".SET" folder containing the data you wish to load, and touch Open to open the ".SET" folder. A list of User data appears (Global, Performance, SongBook, Sounds, Style...).

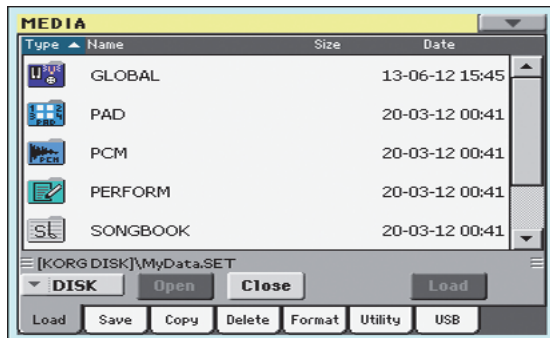

5. Select the folder containing the type of data you are looking for, and touch Open to open the selected folder. A list of banks appears.

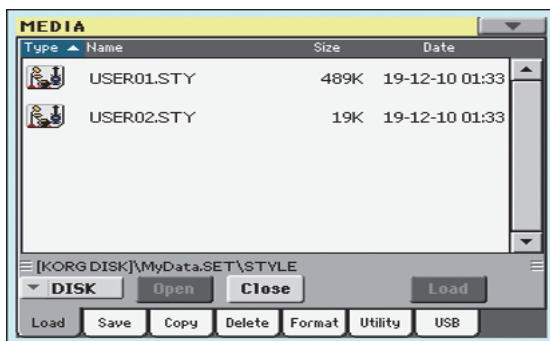

6. Select the bank file you are looking for, and touch Open to open it. A list of items appears.



7. Select the item you are looking for, and touch Load to confirm the load. A dialog box appears, asking you to select one of the available locations in memory.



In the dialog box above, the Style you select from disk will be loaded into location 01 of the bank Usr01 in memory. Any existing Style at the same location will be deleted and overwritten.

Empty locations are named “- - -”.

8. Select the target location, and touch OK to load the source file.

Warning: After confirming, the item you are overwriting in memory will be deleted.

Note: You can save space for loading new data by deleting all unused PCM Samples from memory. When Sounds or Drum Kits based on external PCM Samples are deleted, you no longer need the now unassigned PCM Samples. Use the “Not assigned to any Multisample/Drumkit” Delete option in the Sampling mode to delete all the unassigned Samples (see page 244).

Note: If you are loading a Sound or Drum Kit making use of external PCM Samples, the Samples are automatically loaded (unless they are already in memory).

Loading Global data from other Pa-Series instruments

Global data (Global, Voice Processor, Limiter, EQ, etc.) cannot be loaded from other Pa-Series instruments.

Loading Pa3X data

You can load Pa3X data exactly as if they were Pa900 data, apart for the Global data. Sounds and Effects can be a bit different. Due to the different order in memory, Styles must be reassigned to SongBook Entries by using the SongBook Editor software (freely available on www.korg.com).

Loading Pa600 data

You can load Pa600 data exactly as if they were Pa900 data, apart for the Global data. Due to the different order in memory, Styles must be reassigned to SongBook Entries by using the SongBook Editor software (freely available on www.korg.com).

Loading Pa2X/Pa800 data

You can load Pa2X/Pa800 data exactly as if they were Pa900 data, apart for the Global data. Due to the different order in memory, Styles must be reassigned to SongBook Entries by using the SongBook Editor software (freely available on www.korg.com).

It is not possible to load Pa900 data into a Pa2X/Pa800.

Loading Pa1X data

You can load Pa1X data exactly as if they were Pa900 data, apart for the Global data. Due to the different order in memory, Styles must be reassigned to SongBook Entries by using the SongBook Editor software (freely available on www.korg.com).

It is not possible to load Pa900 data into a Pa1X.

Loading Pa500/588 data

You can load Pa500/588 data exactly as if they were Pa900 data, apart for the Global data. Due to the different order in memory, Styles must be reassigned to SongBook Entries by using the SongBook Editor software (freely available on www.korg.com).

It is not possible to load Pa900 data into a Pa500/588.

Loading Pa80/60/50/50SD data

You can load Pa80/60/50/50SD data exactly as if they were Pa900 data, apart for the Global data. The only difference is that the “SOUND” folder of Pa900 is called “PROGRAM” in the Pa80/60/50/50SD. Therefore, to load Sounds from Pa80/60/50/50SD disks, you must accomplish one of the following operations, either:

- Rename the “PROGRAM” folder “SOUND” (by using a personal computer) before loading a “.SET” folder; or
- First load the “.SET” folder, then separately load the “.PCG” file from the “PROGRAM” folder.

Loading i-Series data

Pa900 is compatible with the Styles of the older i-Series instruments. You can load them as if they were ordinary Pa900 data.

1. Copy the old i-Series data into an USB device, or transfer them to the internal storage memory of the Pa900.
2. Press MEDIA to go to the Media mode. Select the Load page if needed.
3. While in the Load page, select the device containing the i-Series data from the Device pop-up menu.
4. If you are reading an i30 file, select the “.SET” folder and touch the Open button in the display.
5. Select the “.STY” folder.
6. At this point, you can load the whole “.STY” folder, or open it and select a single Style.

- To load the whole folder, touch the Load button in the display. If it contains more than 40 Styles, they will be loaded into the USER banks sequentially, otherwise you will be prompted to select one of the USER Style banks or the FAVORITE Style banks in memory. Once the target bank is selected, touch Load to load the bank. The “Are you sure?” message will appear. Touch OK to confirm, or Cancel to abort.

- To load a single Style, touch Open in the display to open the “.STY” folder. Since a conversion will be started at this point, please wait some seconds for the operation to be completed.

Select the Style to load, then touch Load. You will be prompted to select a target location in memory. Once the target location is selected, touch Load to load the Style. The “Are you sure?” message will appear. Touch OK to confirm, or Cancel to abort.

Note: Loading a whole “.SET” folder from an i30 file may take some time due to format conversion.

7. Go to the Style Play mode, and select (one of) the loaded Style. Adjust the Tempo value, then select the “Write Current Style Settings” to write changes. Touch OK twice to confirm.
8. Due to the difference in Sounds, you will probably want to make some adjustments to the old Styles, once they are loaded in Pa900 (changing the Sound, Volume, Pan, Tempo, Drum Mapping, Wrap Around...).
9. To make the Sound assignment to the Style tracks effective, be sure the “Original Style Sounds” parameter is not checked (see page 110).
10. Save the Style Settings again. Select the “Write Current Style Settings” to write changes. Touch OK to confirm.

Save

In this page, you can save User data from the internal memory to a mass storage device (like an hard disk or an USB memory stick). You can save single files, banks, or all the User and Favorite Style files of the internal memory.

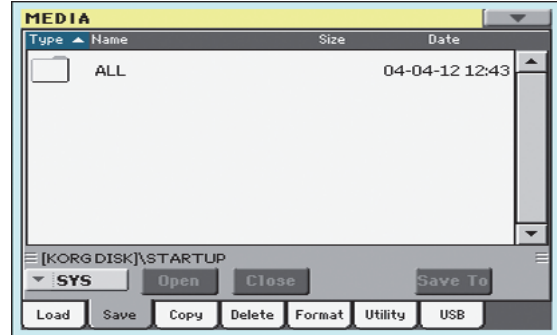

Note: While in this page, only data allowed for saving are shown. All other files are hidden.

Here are the various types of files contained in the internal memory:

The file/folder type...	...contains...	...and will create on the target device...
All	All the User data in memory	A .SET folder
Style	The FAVORITE 01-12 Styles and the USER 01-03 Styles	A STYLE folder inside a .SET folder
Sound	The USER Sounds and Drum Kits	A SOUND folder inside a .SET folder
Pad	The USER Pads	A PAD folder inside the .SET folder
Perform (Performances)	The Performances	A PERFORM folder inside a .SET folder
SongBook	The SongBook database	A SONGBOOK folder inside a .SET folder
PCM	All the Multisamples contained in the internal storage memory, and the PCM Samples contained in RAM	A PCM folder inside a .SET folder
Global	All global parameters. MIDI Presets, SC Presets, Limiter Presets, Master EQ Presets and VP Presets are also saved.	A GLOBAL folder inside a .SET folder. Inside the GLOBAL folder other folders will be created, to contain the MIDI, SC, Limiter, Master EQ Presets and VP Presets.

Creating a new “.SET” folder

Pa900 proprietary data must be saved in special folders with the “.SET” extension. These special folders can be saved inside ordinary folders.

When saving, you can save onto existing “.SET” folders, or you can create a new folder of this type. Here is how to do it.

1. When the directory of the target device is shown in the display, the “New SET” button appears among the buttons below the file list.



2. Touch the New SET button. A dialog box appears, asking you to enter a name for the new “.SET” folder.



3. Touch the **T** (Text Edit) button to open the Text Edit window. Enter the name, then touch OK to confirm and close the Text Edit window. **Note:** The “.SET” file name extension is added automatically.
4. Touch OK to create the new folder and exit the dialog box.

Saving the full memory content

You can save the full memory content with a single operation. Depending on the status of the “Factory Style and Pad Protect” parameter, you may or may not see the Factory Style and Pad banks (see “Factory Style and Pad Protect” on page 254).

1. If saving to an external device, connect the device to the USB Host port.
2. The full content (“All”) of the internal memory is already shown. Select it, and touch Save to confirm the selection. The list of files in the target device is shown.

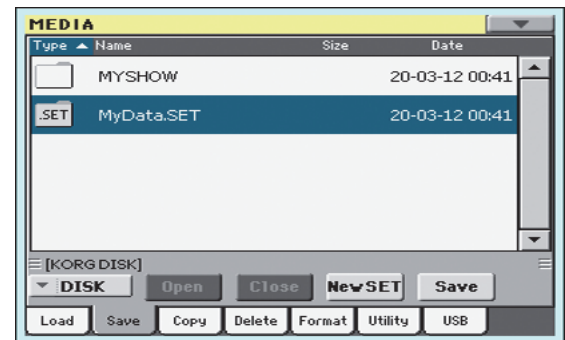

3. If needed, use the Device pop-up menu to select a different target device. When the target device is selected, its content will appear in the display.
4. At this point, you can:
 - Touch the New SET button and create a new “.SET” folder (see “Creating a new “.SET” folder” on page 285), or
 - Select an existing “.SET” folder.
5. Touch Save to confirm. A dialog box appears, asking you to select the type of data to save:



Save All dialog with the Factory Style and Pad Protect option turned on



Save All dialog with the Factory Style and Pad Protect option turned off

In the dialog box above, check all data type you wish to save to a storage device.

6. Touch OK to confirm, or Cancel to abort.

Warning: After confirming, all data of the selected type in the target folder is deleted.

Saving all data of a specified type

In addition to the above, you can save all data of a specified type by selecting the corresponding folder.

1. If saving to an external device, connect the device to the USB Host port.
2. The full content (“All”) of the internal memory is already shown. Select it, and touch Open to open it. A list of User data types appear (each type is a separate folder).

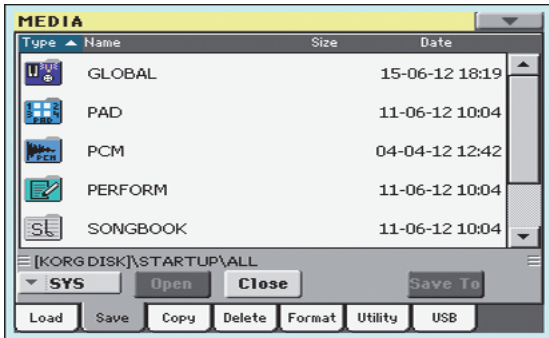

3. Select the folder containing the type of data you wish to save, and touch Save To to confirm the selection. The list of files of the target device is shown.

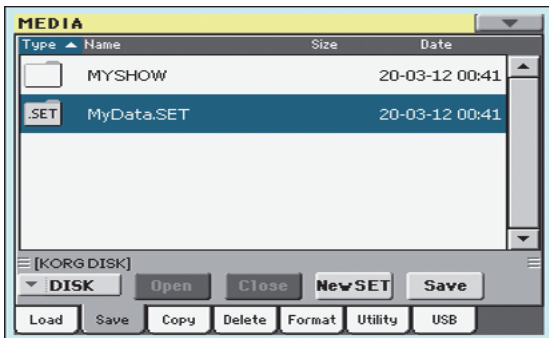

4. If needed, use the Device pop-up menu to select a different target device. When the target device is selected, its content will appear in the display.
5. At this point, you can:
 - Touch the New SET button and create a new “.SET” folder (see “Creating a new “.SET” folder” on page 285), or
 - Select an existing “.SET” folder, and touch Save to confirm.

Warning: After confirming, all data of the selected type in the target folder is deleted.

Saving a single bank

You can save a single User bank with a single operation. Each bank corresponds to each of the side tabs in the various Select windows (Style Select, Performance Select...).

1. If saving to an external device, connect the device to the USB Host port.
2. The full content (“All”) of the internal memory is already shown. Select it, and touch Open to open it. A list of User data types appear (each type is a separate folder).

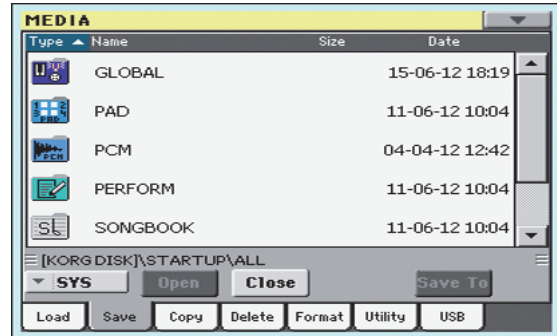

3. Select the folder containing the type of data you wish to save, and touch Open to open it. The list of contained bank files is shown.

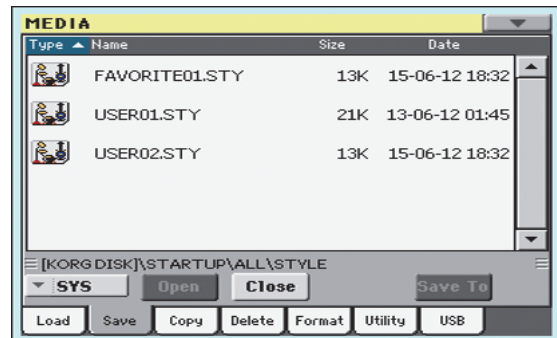

4. Select the bank file to be saved, and touch Save To to confirm the selection. The list of files of the target device is shown.

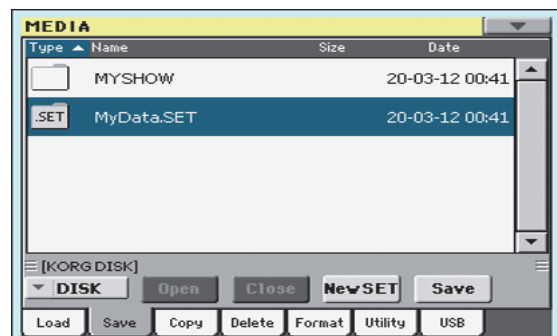

5. If needed, use the Device pop-up menu to select a different target device. When the target device is selected, its content will appear in the display.
6. At this point, you can:
 - Touch the New SET button and create a new “.SET” folder (see “Creating a new “.SET” folder” on page 285), or
 - Select an existing “.SET” folder, and touch Save to confirm.

- A dialog box appears, asking you to select one of the available User (or Favorite/User Style) locations inside the folder:

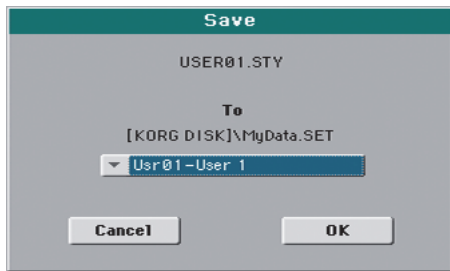

In the above dialog box, the previously selected bank of Styles will be saved to bank User 01 inside the selected folder. Three User banks are available.

- Touch OK to confirm, or Cancel to abort.

Warning: After confirming, the same bank in the target folder is deleted.

Saving a single item

You can save a single User item with a single operation.

- If saving to an external device, connect the device to the USB Host port.
- The full content (“All”) of the internal memory is already shown. Select it, and touch Open to open it. A list of User data types appear (each type is a separate folder).



- Select the folder containing the type of data you wish to save, and touch Open to open it. The list of contained bank files is shown.

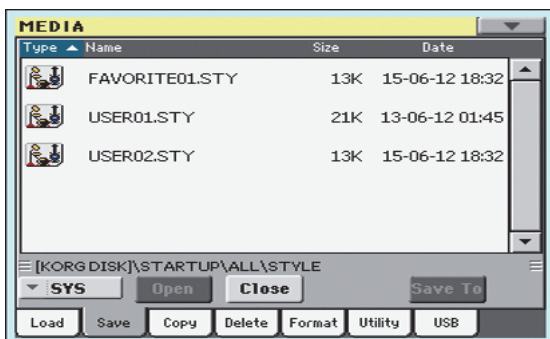

- Select the desired bank file, and touch Open to gain access to the single items.



- Once you have selected the file that you want to save, touch Save To to confirm the selection. The list of files of the target device is shown.

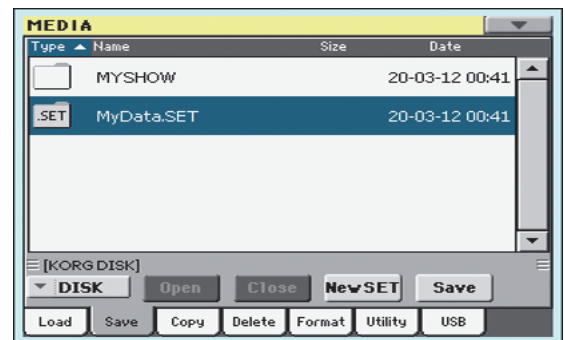

- If needed, use the Device pop-up menu to select a different target device. When the target device is selected, its content will appear in the display.

- At this point, you can:

- Touch the New SET button and create a new “.SET” folder (see “Creating a new “.SET” folder” on page 285), or
- Select an existing “.SET” folder, and touch Save to confirm.

- A dialog box appears, asking you to select one of the available User (or Favorite Style) locations inside the selected folder

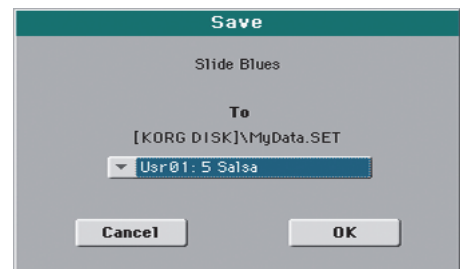

In the above dialog box, the previously selected Style will be saved to location 01 inside the bank Usr01 inside the selected folder.

- Touch OK to confirm, or Cancel to abort.

Warning: After confirming, the same item in the target folder is deleted.

Copy

In this page you can copy files and folders. Folders can be generic or “.SET” folders. In addition, you can copy the content of the generic folder you are in. You can copy inside the same device, or from a device to a different one (both devices must be connected to the Pa900 during the copy operation).

To preserve data structure integrity, during Copy operations you can't open “.SET” folders and copy only one of the files it contains. You can only open and go inside generic folders.

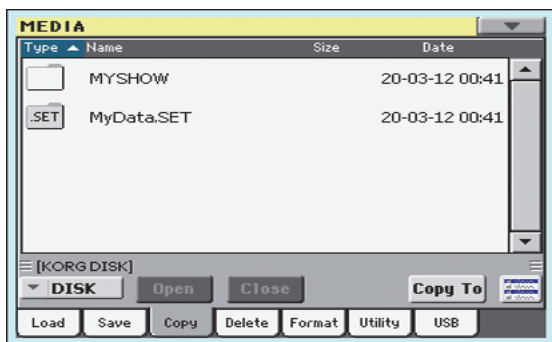

Contrary to the Load and Save pages, in this page you may see all types of files, and not only Pa-Series supported files (assuming the “Hide Unknown Files” option is turned off, see page 254).

Copying a folder's content

If nothing is selected while a folder is open in the display, you can copy the folder's content, without copying the folder itself.

Note: During the Copy procedure, you can't open a “.SET” folder. You can, however, open any generic folder.

1. If copying from or to an external device, connect the device to the USB Host port.
2. Select the source device, by using the Device pop-up menu.
3. If the folder you are looking for is inside another folder, select this latter and touch the Open button to open it. Touch the Close button to go back to the parent folder.
4. To copy the current folder's content, without copying the folder itself, do not select anything in the display.
5. Touch Copy To to confirm. The target device appears.

Note: If the selected device is not available, the “Device not found, or unknown format” message will appear. A different device will be automatically selected.

6. If needed, select the target device, by using the Device pop-up menu.
7. If you want to select a different folder, use the Open and Close buttons to move through the directories.
 - To copy into an existing generic folder (not a “.SET” folder), select that folder.
 - To copy into the current folder, do not select anything.
8. Once the target is selected, touch Copy.

If a file or folder with the same name of the source data already exists at the target location, the “Overwrite” dialog box will appear (see “Overwriting existing files or folders” on page 289).

During Copy, a dialog box shows the progress of the operation.

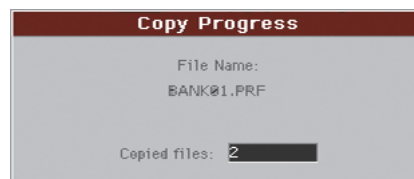

Copying a single file or folder

You can copy a single file or folder, from the root or a generic folder to a different one. You can't copy single files or folders from inside a “.SET” folder.

1. If copying from or to an external device, connect the device to the USB Host port.
2. Select the source device, by using the Device pop-up menu.
3. Select the folder containing the file or folder you wish to copy. If it is contained in another folder, touch the Open button to open it. Touch Close to go back to the previous hierarchic level.
4. Touch Open to open the folder containing the file or folder to be copied.
5. Select the file or folder to be copied, then touch Copy To to confirm its selection. The target device appears.

Note: If the selected device is not available, the “Device not found, or unknown format” message will appear. A different device will be automatically selected.

6. If needed, select the target device, by using the Device pop-up menu.
7. When the target device content appears in the display, select the target folder. Touch Open to open a folder, or Close to close it.
8. Once the target is selected, touch Copy.

If a file or folder with the same name of the source data already exists at the target location, the “Overwrite” dialog box will appear (see “Overwriting existing files or folders” below).

Multiple file selection

While in the Copy and Delete pages of the Media mode, you can select several files or folders at the same time before executing the operation. Files or folders can be selected consecutively (i.e., in a row), or discontinuously (i.e., with other files or folders in the middle).

To choose either to select files in a consecutive or discontinuous way, use the Mode button on the right of the page command buttons, to choose an option for the SHIFT button:



Choose this option to select files or folders consecutively (i.e., in a row).



Choose this option to select files or folders discontinuously (i.e., with other files or folders in the middle).

To select more files or folders consecutively:

1. Touch the Mode button to choose the  option for the SHIFT button.
2. Select the first file or folder to be selected.
3. Press and keep the SHIFT button pressed.
4. Select the last file or folder to be selected.
5. Release the SHIFT button.

To select more files or folders discontinuously:

1. Touch the Mode button to choose the  option for the SHIFT button.
2. Select the first file or folder to be selected.
3. Press and keep the SHIFT button pressed.
4. Select a second file or folder to be selected.
5. While keeping the SHIFT button pressed, continue selecting the other files or folders to be selected.
6. Release the SHIFT button.

To deselect the files or folders:

- To deselect one or more file or folder, without deselecting everything, keep SHIFT pressed and touch the file or folder to be deselected.
- To deselect everything, select any other file or folder. All selected files and folders will be deselected.

Overwriting existing files or folders

When copying files, a file or folder with the same name of a source element might be found in the target device. In this case, Pa900 asks you if you want to overwrite it.

When a duplicate file or folder is met, the following dialog box appears:

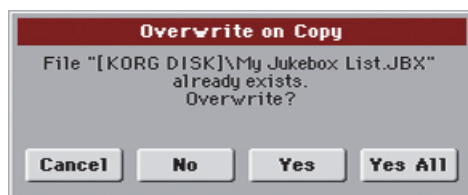

Cancel	The procedure is interrupted.
No	The file or folder is not overwritten. The source file or folder is not copied. The procedure will continue with the other files and folders.
Yes	The file or folder is overwritten. The procedure will continue with the other files and folders.
Yes (to) All	The file or folder is overwritten. Any following duplicate file or folders will be overwritten as well, without this dialog box appearing again. The procedure will continue with the other files and folders.

Delete

The Delete function lets you delete files and folders from the devices.

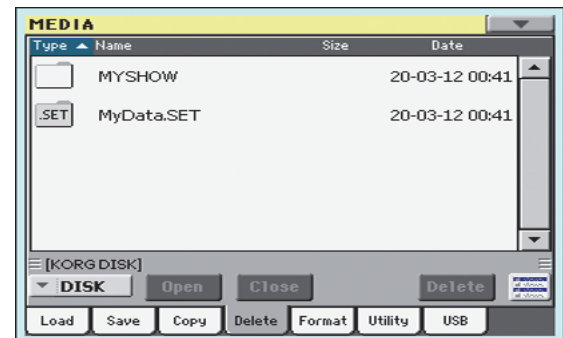

Contrary to the Load and Save pages, in this page you may see all types of files, and not only Pa-Series supported files (assuming the “Hide Unknown Files” option is turned off, see page 254).

Delete procedure

1. If erasing from an external device, connect the device to one of the USB Host ports.
2. If needed, select a different device, by using the Device pop-up menu.
3. If the file or folder you are looking for is inside another folder, select this latter and touch the Open button to open it. Touch the Close button to go back to the parent folder.
4. Select the file or folder to erase.
5. Touch Delete to delete the selected item.

During erase, a dialog box shows the progress of the operation.

Multiple file selection

See “Multiple file selection” on page 288 for information on how to select more files or folders to be erased at the same time.

Format

The Format function lets you initialize a device. Pa900 uses a PC-compliant device format (DOS FAT16 and FAT32):

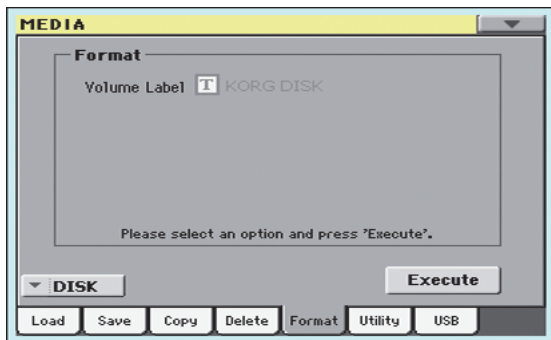

Warning: When formatting a device, all data it contains is lost forever!

Volume Label

Use this parameter to assign a name to an external device to be formatted.

Note: You cannot rename the label (name) of the internal volume. When formatting the internal disk, the label cannot be edited.

Touch the **T** (Text Edit) button to open the Text Edit window. Enter the name, then touch OK to confirm and close the Text Edit window.

Note: When changing the name to a device containing Standard MIDI Files or MP3 files used in the SongBook, the links are broken. We suggest to give the device the same name it had before formatting. In case you changed the name, please use SongBook Editor (freely available on www.korg.com) to edit the links.

Warning: It is not possible to change the label (name) of the internal disk when Pa900 is connected to a PC through the USB port. If you try to do it, the original name is restored by Pa900.

Execute button

Touch this button, after having assigned a name to the volume, to execute the Format command.

Format procedure

Here is how to format a device.

1. If formatting an external device, connect the device to the USB Host port.
2. Choose the device to be formatted by using the Device pop-up menu in the lower-left corner of the display.
3. Touch the Execute button in the display to confirm formatting.
4. The “If you confirm, all data in the media will be lost. Are you sure?” message appears in the display. Touch Yes to confirm, or No to cancel.

Note: When formatting the hard disk or an external USB device, an additional warning appears, to avoid accidental data loss.

Utility

This page includes a set of backup and restore utilities. The Backup command should be used for archiving purpose only, since you will not be able to load individual data from a backup file. To save data that must remain accessible with the normal Media > Load operations, for example to load User data after updating the Musical Resources, use the Media > Save operations instead.

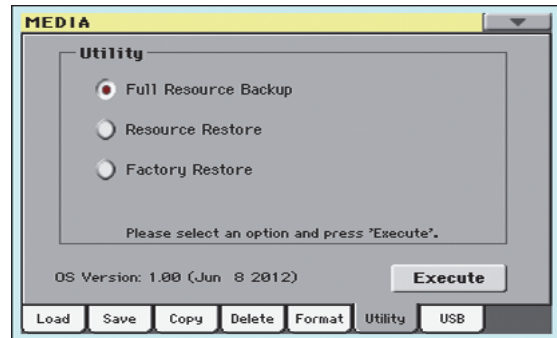

Full Resource Backup

This command allows you to make a full backup of all the internal data on a target device. A “.BKP” file will be created.

Hint: This command cannot be used to save single items (like a single Style, a bank of Performances...). To do that, use the Save operations instead.

1. In case you are making the backup on an external USB device, connect the device to one of the USB Host ports.
Be sure there is enough free space in your target device, or the Backup procedure will not be completed.
2. Select the “Full Resource Backup” command, then touch the Execute button in the display. The target device appears.

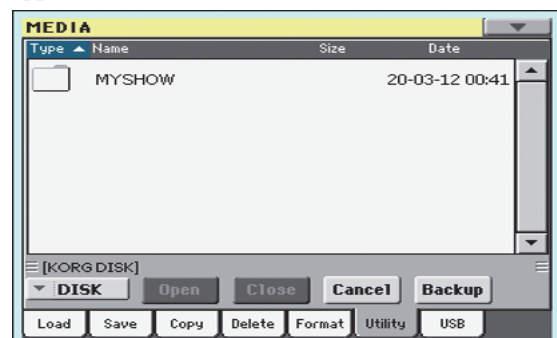

3. If needed, select a different device, by using the Device pop-up menu.
4. If you wish to save data inside another folder, select this latter and touch the Open button to open it. Touch the Close button to go back to the parent folder.
5. Select the folder where to save data, and touch Backup to save it. If nothing is selected, data will be saved to the current directory.

After touching Backup, a dialog box will appear, asking you to assign a name to the backup file.

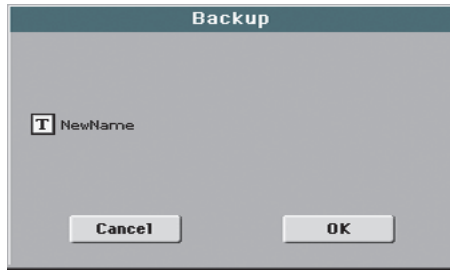

Touch the **T** (Text Edit) button to open the Text Edit window. Enter the name, and confirm by touching OK.

6. Touch OK to start the backup.
7. When finished, save the (removable) storage device in a safe place.

Full Resource Restore

This command restores data from a backup of the internal Factory and User data, created with the “Full Resource Backup” command.

Hint: This command cannot be used to load single items (like a single Style, a bank of Performances...). You can only load all data, or full data types. Backups are compact archives, that can only be restored as a full package.

Note: Loading a backup file created with other Pa-Series and i-Series instruments is not allowed.

Warning: Don't play the keyboard while restoring data, and stay in the Media mode. Wait until the “Wait” message disappears.

1. In case you are restoring from an external USB device, connect the device to the USB Host port.
2. Select the Restore Resources command, then touch Execute. The source device appears.
3. If needed, select a different device, by using the Device pop-up menu.
4. Browse through the files to find the backup file.
5. When the backup file (“BKP” file) is in the display, select it and touch the Restore command.
6. A dialog box will appear, with a list of types of data to be restored. Only check the types of data you want to restore.



Warning: This command will delete from the internal memory all types of data selected in this dialog box (including your custom data).

7. When done, a message appears asking you to restart the instrument (“Data Restored. Please switch off”). Set the instrument to standby mode, then turn it on again.

Factory Restore

In case you want to erase all changes to your Factory and User data, and restore your Pa900 to the same condition it was when it was new, you can use the Factory Restore procedure.

Warning: This command deletes all data from memory (including your custom data).

1. Select the Factory Restore command, then touch Execute.
2. A dialog box will appear, with a list of types of data to be restored. Only check the types of data you want to restore.



Warning: This command will delete from the internal memory all types of data selected in this dialog box (including your custom data).

3. When done, a message appears asking you to restart the instrument (“Data Restored. Please switch off”). Set the instrument to standby mode, then turn it on again.

OS Version Number

This line shows the installed Operating System version. From time to time, check our web site (www.korg.com), to see if a newer, free version has been released.

USB

Use this page to enable or disable the USB Device port for file transfer.

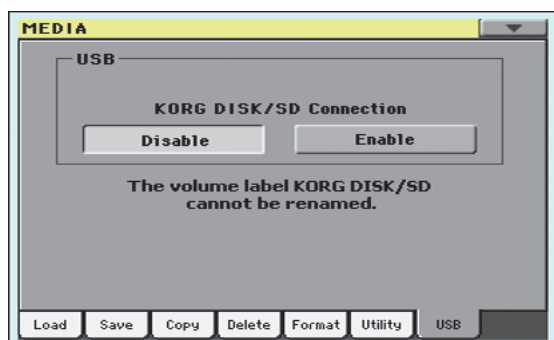

The USB Device port allows you to access the internal storage memory from a personal computer, by just connecting the Pa900 to the computer's USB interface. This way, you can exchange files between the user-accessible area of the internal storage memory of the Pa900 (DISK device), the microSD card (SD devices), and a personal computer.

Note: The drivers supplied in the Accessory Disc are only for MIDI Over USB connection.

Note: While USB file transfer is enabled, you cannot access other functions on the Pa900. MIDI Over USB is also disabled.

Warning: It is not possible to change the label (name) of the internal disk or microSD card when Pa900 is connected to a PC through the USB port. If you try to do it, the original name is restored by Pa900.

HD Connection

Usually, the USB Device port is not enabled for file transfer on the Pa900 (it is always on, however, for MIDI connection). Touch the Enable button to turn it on, or the Disable button (with all the caveats) to turn it off.

1. Connect Pa900 to a personal computer by using a standard USB cable
2. Touch the "Enable" button to enable file transfer. Pa900 becomes the B USB device (called *Device* or *Slave*), while the personal computer becomes the A USB device (called the *Host* or *Master*).

When finished, the icon of the internal memory of Pa900 will appear among the other storage devices connected to the computer.

Caveat: Do not modify the structure of the ".SET" folders, or you will no longer be able to use them on the Pa900. Only use the USB connection for data exchange purpose, or to modify ordinary folders.

Note: After starting the USB connection, accessing Pa900 data from the computer may take some time, depending on the size of the hard drive and the data contained in the hard drive.

3. When all data has been transferred, disconnect USB communication from the computer. On a PC, you usually select the dedicated command by clicking on the USB device icon with the right mouse button. On the Mac, select the USB device icon, then select the Eject command or drag it to the eject icon in the Dock.
4. When the Pa900 icon disappears from the computer's desktop, touch the "Disable" button on the display of Pa900.

Caveat: Do not disconnect the USB communication before the personal computer has really finished transferring files. Sometimes, the on-screen indicator tells the procedure has been completed BEFORE it has really finished.

Disconnecting USB communication (or disconnecting the USB cable) before data transfer has been completed may cause data loss.

Page menu

Touch the page menu icon to open the menu. Touch a command to select it. Touch anywhere in the display to close the menu without selecting a command.

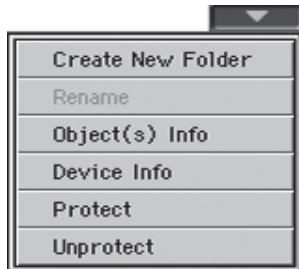

Create New Folder

This command lets you create a new generic folder. You can't create a ".SET" folder with this command, since this type of folder is reserved to the Save operations (and can be created with the New SET button in any Save page).

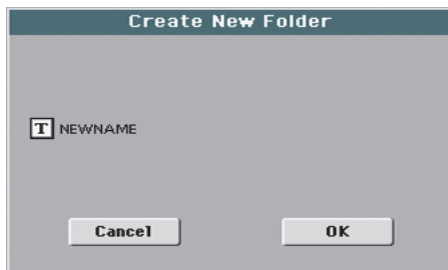

By touching the **T** (Text Edit) button you can open the Text Edit window. Enter the name, then touch OK to confirm and close the Text Edit window.

Rename

Available only when an item is selected in a file list.

Use this function to change the name of an existing generic file or folder. To preserve consistency through the data structure, you cannot rename folders and files inside a ".SET" folder. Also, you cannot change the 3-character extension of files and ".SET" folders, since they are used to identify the type of file or folder.

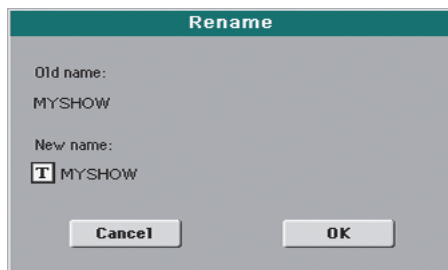

Touch the **T** (Text Edit) button to open the Text Edit window. Enter the new name, then touch OK to confirm and close the Text Edit window.

Object(s) info

Select this command to see the size of any selected file or folder. Also, the number of files and directories (folders) it contains are shown.

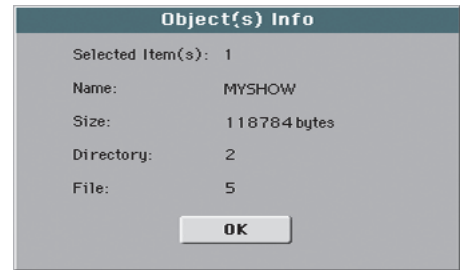

Note: The **single file** size is always shown to the right of the file name in any file list (assuming the "Size" parameter is turned on, see page 254):

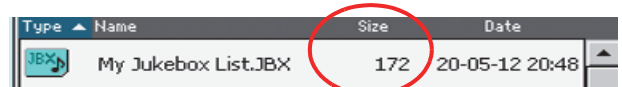

Device Info

Select this command to see various info on the selected device. To select a different device, use the Device pop-up menu on the lower left corner of most Media pages.



By touching the **T** (Text Edit) button you can open the Text Edit window. Enter the name (label) of the selected device, then touch OK to confirm and close the Text Edit window.

Warning: If you change the name of a device connected to the USB Host port, and it contains files used by some SongBook Entries, these entries will no longer be able to find the linked resources contained in the device. In this case, either restore the original device name, or use the SongBook Editor software (freely available on www.korg.com) to edit the links.

Note: You cannot change the name of the internal storage memory or the internal microSD card.

Protect

Select this command to protect the selected file or folder from writing/erasing. The lock icon will appear next to the file or folder name.



Unprotect

Select this command to unprotect the selected file or folder – if protected.

Care of mass storage devices

The Pa900 can save most of the data contained in memory to the internal memory, or to external devices (like hard drives or USB memory sticks) connected to the USB Host port. Here are some precautions when handling these devices.

Internal memory write protection

You can protect your internal memory from writing, by using the software protection found in Global mode (see “Media Protect” on page 254).

Precautions

- Do not remove a device or move the instrument while the device is operating.
- In order to avoid losing data in case of damage, make a backup copy of the data contained in a device. You can backup your data to a personal computer, and from there to a backup unit. You can transfer data from the internal memory of Pa900 (DISK unit) to a personal computer by using the USB Device connection.
- Do not leave an USB device connected to the USB ports while carrying the instrument, or it may be damaged.
- Keep the memory devices or the instrument away from sources of magnetic fields, for example televisions, refrigerators, computers, monitors, speakers, cellular phones and transformers. Magnetic fields can alter the contents of the devices.
- Do not keep memory devices in very hot or wet places, do not expose them to direct sunlight and do not store them without use in dusty or dirty places.
- Do not place heavy objects on top of the devices.
- Regular care is recommended with your devices. Defragmenting and repairing internal devices can be made with any computer utility while the Pa900 is connected via USB.

Possible problems

- Magnetic fields, dirt, humidity and usage can damage data in a device. You can try to recover the data with disk repair utilities for personal computers. It is, however, advisable to always make a backup copy of your data.

Merging Samples from various sources

When you load a .SET folder, all User PCM Samples in memory are deleted. So, there is no way to merge different samples by loading complete .SET folders.

To merge samples from several sources, you must load single Sounds or Drum Kits based on User PCM Samples.

Delete all samples and multisamples

1. If you want to delete all Samples and Multisamples already in memory, press the SOUND button to access the Sound mode, then press the RECORD button to access the Sampling mode.
2. While in Sampling mode, choose the “Delete” command from the page menu. Choose the “All Samples, MultiSample, DrumSamples” option, and touch OK to delete all Samples and Multisamples.
Warning: Before deleting, be sure to have a copy of any important data you don't want to lose.
3. To exit from the Sampling mode, choose the “Exit from Record” command from the page menu.

Create a new .SET of samples

1. Press the MEDIA button to access the Media mode. Go to the Load page.
2. Open a first .SET folder containing some of the PCM Samples to merge. Open the SOUND folder, then one of the USER banks, and choose the first of the Sounds or Drum Kits based on samples you would like to load. Touch Load, and choose a target User location in memory.
The Sound or Drum Kit is loaded, together with the PCM Samples it is based on.
3. Do the same with any subsequent Sound or Drum Kit whose Samples you would like to load.
4. When finished loading, save a new .SET folder, being sure the PCM option is checked in the Save All dialog (see “Saving the full memory content” on page 285, or “Saving all data of a specified type” on page 286).

SongBook

The SongBook is a musical database that allows you to organize songs and automatically recall the associated “musical resources” (Style, Standard MIDI Files, KAR files, and MP3 files).

The SongBook overlaps the Style Play and Song Play operating modes. When you select an entry from the full database or a custom list, the Style Play or Song Play mode is automatically selected, depending on the type of file associated with the entry.

In addition to helping you organize your shows, the SongBook allows you to associate a Voice Processor Preset, four Pads, and up to four STSs to each Style, Standard MIDI File or MP3 file, to recall a complete set of Keyboard tracks for realtime playing over a Song. You can also link a separate text file containing lyrics to an entry.

Note: SongBook Entries do not include actual data; they are just pointers to a Style, a Standard MIDI File an MP3 or a TXT file. When you copy a SongBook file, referenced files are not copied with it.

Hint: Use the SongBook Editor software (freely available from our web site) to edit your SongBook on a PC.

Warning: If you load a SongBook file from a storage device, the existing one in memory (including the custom lists) is deleted. Save your old SongBook file before loading a new one.

Book

The Book page contains the full database of song entries. While in this page, you can select an entry, and touch the Select button in the display to load it. Then, press the PLAY or START button to start the Song or Style.

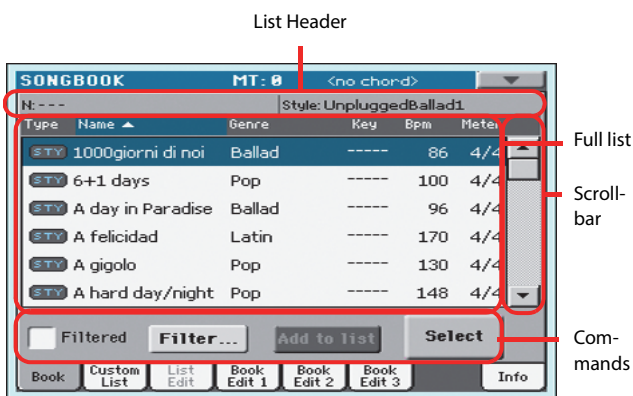

Each entry of this database may include the song’s author, name, genre, original key, tempo and meter (time signature). When selecting one of the entries, the associated Style, Standard MIDI File or MP3 file is automatically recalled, together with any TXT lined to the entry. Also, a Voice Processor Preset, the STSs and Pads may be recalled.

List Header

The List Header may change, depending on the type of data associated with the selected entry.

- When a Style is associated to the entry, the currently selected entry’s name is shown on the left (“N:”), and the associated Style is shown on the right (“Style:”):

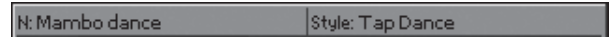

- When a Standard MIDI File or MP3 file is associated to the entry, the list header is split into two parts, with the left half referring to Player 1, and the right one referring to Player 2.

Information for the selected entry’s name (“N:”) and the associated Standard MIDI File or MP3 file (“P1:” or “P2:”) is given for each player:



Note: If you select a different Style or Standard MIDI File or MP3 file, the entry’s name field (“N:”) returns blank (---), meaning the entry has been modified.

Full list

This is the full list of the SongBook database. Use the scrollbar (or the VALUE DIAL) to browse through the list.

You can touch one of the heading labels above the list to change the order in which entries are shown. For example, by touching the “Name” label, the list is alphabetically re-ordered according to the entry names. The selected label become highlighted, showing the currently selected ordering.

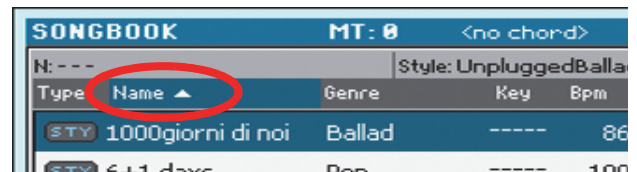

By touching the label again, the order of the files switches between ascending and descending. The small arrow next to the label name shows the selected order.

Scrollbar

Use the scrollbar (or the VALUE DIAL) to scroll the entries. You can keep the SHIFT button pressed while touching the scrollbar, to quickly jump to the next/previous section.

Commands

Filtered

When this box is checked, only entries matching the selected filter criteria are shown in the full list. The box is automatically checked when you exit from the Filter dialog box by touching OK (see below).

Filter...

Touch this button to open the Filter dialog box, and select one or more filter criteria, to show a restricted set of entries in the main list.

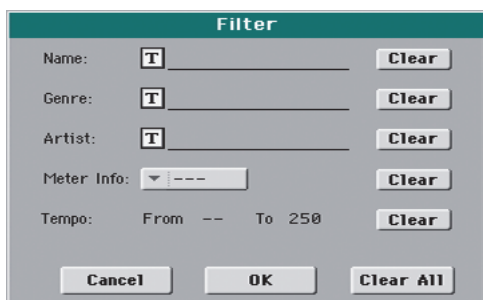

Touch the **T** (Text Edit) button next to the search criteria you want to edit (Name, Genre, or Artist). You can also select a Meter, or a range of Tempo values.

Touch the Clear button next to the search criterion you want to delete or set to a default value.

Touch Clear All to reset all search criteria.

Note: You can also find items in the SongBook database by pressing the SEARCH button, and using the Search function. However, the Filter function allow for a more refined search.

Add to list

If the “Enable List Edit” command is selected in the page menu, the “Add to list” button becomes available, to let you add entries to the selected Custom List.

Select an entry, then touch this button to add the selected entry to the current Custom List (see “Custom List” on page 297).

Select

Touch this button to confirm selection of the highlighted entry in the full list. After touching this button, the name of the selected entry appears in the left upper side of the display (“N:”).

When you highlight a song in any of the SongBook lists, its name appears in reversed text, over a green-blue background. While in this situation, the song is highlighted, but not yet loaded.

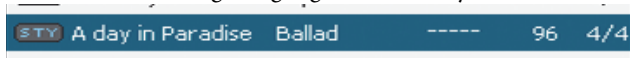

When you touch the Select button in the display, the song will be loaded. The background turns to light green, and the text is turned to boldface, to show the Song has been loaded and ready to play.

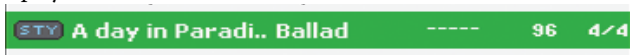

To start playback of the Song or Style, press (respectively) either the PLAY or START button.

Numeric selection of entries

When in SongBook mode, you can select a SongBook Entry by means of an unique number. Numbers associated with each entry can be programmed in the Book Edit 2 page (see “Book Edit 3” on page 301).

To see the numbers while in the Book page, select the “Show Song Numbers (now Key)” command from the page menu:



After you select this command, the “Num” column appears:

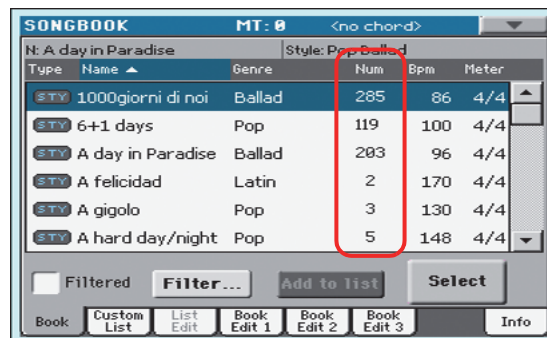

To see the “Key” column again, select the “Show Key (now Song Numbers)” command from the page menu.

To select a SongBook Entry by entering its number, press the SONGBOOK button again while you are in any page of the SongBook mode. The numeric keypad will appear, allowing you to enter the number corresponding to the desired entry.

Hint: You can export a list of SongBook Entries as a TXT file, including the assigned selection number. You can print this list on paper as a memo. (See “Export as text file” on page 302).

Selecting SongBook Entries via MIDI

SongBook Entries can be selected via MIDI (through the special Control channel), by using the dedicated NRPN Control Change messages #99 (MSB, with value 2) and #98 (LSB, with value 64). See “Selecting SongBook Entries via MIDI” on next page.

Setting the special Control MIDI channel

A special MIDI channel used as the “Control” channel is needed to send MIDI messages to select the SongBook Entries.

First of all, choose a MIDI Preset to quickly configure the Control channel. Go to the Global > MIDI > General Controls page and choose a MIDI Preset where to save your settings.

Then, choose a MIDI channel as the “Control” channel. Go to the Global > MIDI > Midi In Channel page, and assign the Control option to one of the sixteen available MIDI channels (usually one of the higher-numbered ones, for example 16).

When done, save this setting to the current MIDI Preset by choosing the “Write Midi Preset” command from the page menu.

Selecting SongBook Entries via MIDI

When you are ready to remotely select SongBook Entries, switch to the Style Play or Song Play mode.

At this point, Pa900 must receive on the special Control channel the NRPN Control Change messages #99 (MSB, with value 2) and #98 (LSB, with value 64) in fast succession, as an initialization string. This string must be sent only once, unless another

NRPN control is sent on the same MIDI channel before selecting a different SongBook Entry.

After the initialization string has been sent, you must send the selection string, made of two Control Change messages: CC#06 (Data Entry MSB) for the thousands and hundreds, and CC#38 (Data Entry LSB) for the tens and units. The range of the Data Entry controls, in this case, is 0~99 (instead of the typical 0~127).

The following examples show some typical situations.

- Send the following string to select SongBook Entry #77:

Data 1	Data 2	
NRPN MSB	2	Initialization string (CC#99, 98)
NRPN LSB	64	
DataEnt MSB	0	Thousands and hundreds (00xx)
DataEnt LSB	77	Tens and units (xx77)

- Send the following string to select SongBook Entry #100:

Data 1	Data 2	
NRPN MSB	2	Initialization string (CC#99, 98)
NRPN LSB	64	
DataEnt MSB	1	Thousands and hundreds (01xx)
DataEnt LSB	0	Tens and units (xx00)

- Send the following string to select SongBook Entry #2563:

Data 1	Data 2	
NRPN MSB	2	Initialization string (CC#99, 98)
NRPN LSB	64	
DataEnt MSB	25	Thousands and hundreds (25xx)
DataEnt LSB	63	Tens and units (xx63)

Custom List

Use this page to select and use one of the available Custom Lists. Custom Lists are lists made of entries extracted from the full SongBook list (as seen in the Book page). They allow the use of smaller, customized SongBook lists, suitable for a single gig or your own music tastes.

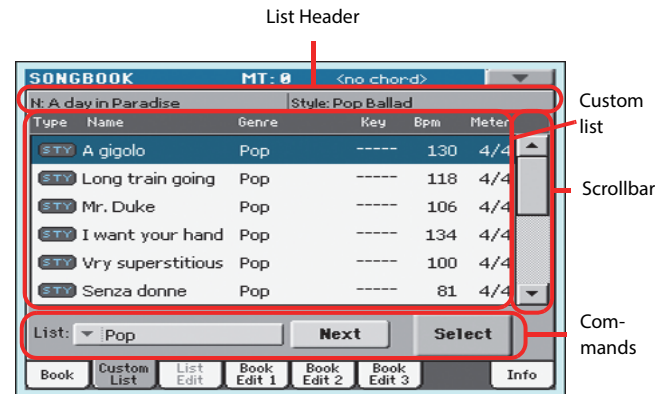

Hint: You can jump to this page by keeping SHIFT pressed, and pressing the SONGBOOK button.

List header

See “List Header” on page 295.

Custom list

List of files contained in the selected Custom List. Use the scrollbar to browse through the list. As an alternative, use the VALUE DIAL.

Scrollbar

Use the scrollbar (or the VALUE DIAL) to scroll the entries.

Commands

List pop-up menu

Use this pop-up menu to select one of the available lists.

Next

Touch this button to select the next entry in the list.

Hint: You can assign this command to an Assignable Switch or Assignable Footswitch.

Select

Touch this button to confirm selection of the highlighted entry in the list. After touching this button, the name of the selected entry appears on the left upper side of the display (“N:”).

Hint: This command is useful to browse through the list, and select an entry different than the one following in the list.

List Edit

This page is only available after checking the “Enable List Edit” command in the page menu (see page 302).

Use this page to edit the available Custom Lists. A Custom List is a set of SongBook Entries, created by selecting items from the full list in the Book page.

To add entries to a Custom List, first create or select the list to be edited in this page. Then, go to the Book page, select the entry to be added, and touch the “Add to list” button. When finished adding entries, return to this page and edit the selected list.

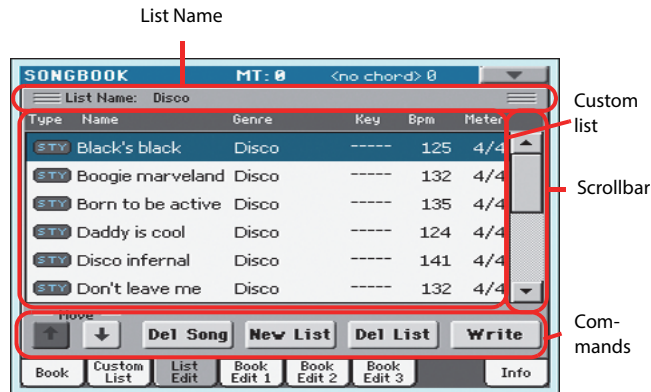

List Name

Name of the selected list. To select a Custom List, go to the “Custom List” page and use the List pop-up menu.

Custom list

List of songs contained in the selected Custom List. Use the scrollbar or the VALUE DIAL to browse through the list.

Scrollbar

Use the scrollbar (or the VALUE DIAL) to scroll the entries.

Commands

Move

Use these buttons to move the selected song entry up or down in the list.

Del Song

Touch this button to delete the selected song entry from the list.

New List

Touch this button to create a new, empty Custom List.

Note: The maximum number of Custom Lists in a SongBook file is 256 lists.

Warning: Any unsaved Custom List is lost when creating a new list using this command.

Del List

Touch this button to delete the current list.

Write

Touch this button to save changes to the selected Custom List.

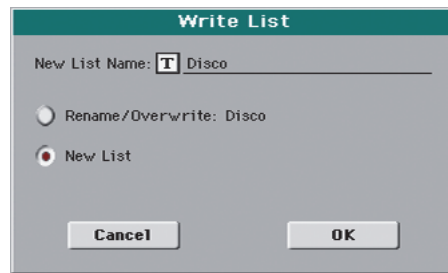

To assign a different name to the selected list, touch the **T** (Text Edit) button to open the Text Edit window.

Select an option to save the edited Custom List:

- Select Rename/Overwrite to overwrite an existing list, optionally changing its name. **Warning:** The older list will be deleted!
- Select New List to save a new Custom List in memory. This list will be available in the “Custom List” page.

Book Edit 1

The Book Edit 1 page is where you link a “musical resource” (Style or Song) to the SongBook Entry, and choose to save STSs and a Voice Processor Preset to the Entry.

Hint: Use the Filter in the Book page, to quickly find an entry to be edited.

The Book Edit 1 page with a Style-based entry:

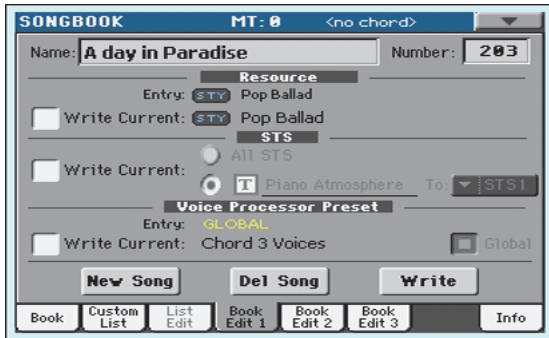

The Book Edit 1 page with a Song-based entry:

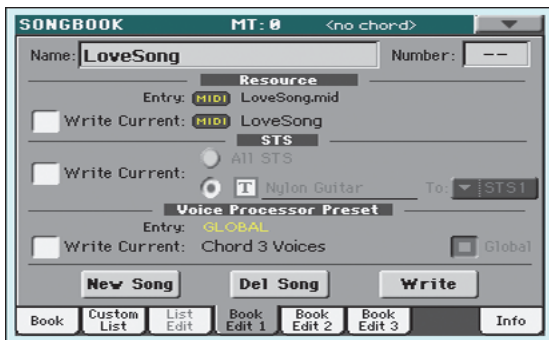

Header

Name

Name of the selected entry. The name is assigned after you touch the Write button to save the entry to the SongBook list.

Number (Song Selection Number)

Here you can select a unique number (up to 9,999) to be associated to the current SongBook Entry. By typing this number (by using the Numeric Keypad) after pressing the SONGBOOK button again, you will be able to quickly recall an entry from the Book page (see “Numeric selection of entries” on page 296).

Assigning a number is not mandatory, but may help you to organize your entries. For example, you can use the different 100s to create a different way of categorizing your entries by genre or age.

Resource

Entry

Style, Standard MIDI File or MP3 file associated with the saved entry.

Warning: If you replace this resource with a different one, using the same Style location number or Song file path, the SongBook

Entry will no longer point to the right data. Be careful not to delete or move a Style or a file associated with a SongBook Entry from the original location.

Write Current

When checked, the currently selected musical resource (whose type and name is shown on the right) is saved to the entry.

You can select a different resource by returning to the Style Play or Song Play mode, and selecting a different Style or Song from there. Then, press the SONGBOOK button to return to the Book Edit 1 page.

What is saved when touching Write depends on the type of associated resource:

- When you are saving a Style-based entry, a reference to the latest selected Style, whose name is shown on the right of this parameter, is saved.

A reference to the selected Pads (whose name you can see by touching the Pad tab in the main page of the Style Play mode) is also saved. Unless changed, Pads are contained into the selected Style.

The Style Settings and the Pad Settings for the referenced Style and Pads are saved. If you edited these Settings (by changing Sounds, Effects, Transpose...), the modified data will be saved instead of the original.

- When you are saving a Song-based entry, a reference to the MID, KAR or MP3 file assigned to Player 1, whose name is shown on the right of this parameter, is saved.

A reference to the selected Pads (whose name you can see by touching the Pad tab in the main page of the Song Play mode) is also saved.

The Pad Settings for the referenced Pads are saved. If you edited these Settings, the modified data will be saved instead of the original.

When this parameter is left unchecked, no new resource will be saved with the entry. The original resources associated with the entry will be preserved when touching Write.

When touching New Song, or keeping the SONGBOOK button pressed for about one second to create a new entry, this parameter is automatically checked and cannot be modified. A reference to the associated resource will be saved with the new entry.

STS

Write Current

When saving a SongBook Entry, and this parameter is checked, you can save the STSs of the associated Style into the entry, or the current Keyboard track settings into a new STS.

All STS All four STSs are saved to the current SongBook Entry. The source STSs are those contained in the Style currently selected in Style Play mode. If you selected a Performance, its Keyboard track settings will be saved as STS #1.

When you touch Write and choose the Rename/Overwrite option, all STSs are overwritten at once.

Single STS The current Keyboard track settings are saved to the chosen SongBook STS.

When you touch Write and choose the Rename/Overwrite option, only the new STS is overwritten, while the others are left untouched.

- **STS Name:** Name of the current STS. Touch the **T** (Text Edit) button to open the Text Edit window, and modify the name.
- **To STS Location:** One of the four STS available for each entry, where you can save the current Keyboard track settings.

Voice Processor Preset

Entry

Voice Processor Preset associated with the saved entry.

Write Current

When checked, the currently selected VP Preset is saved to the entry.

Global

When checked, the Global VP Preset is used.

Buttons

New Song

Touch this button to create a new entry with the current settings. Settings are copied from the selected Style, Standard MIDI File or MP3 file. Also, the selected VP Preset, Pads, STSs and Split Point will be saved. The current Keyboard track settings will be saved as STS #1. Any TXT file loaded in the Lyrics pages will be saved as a linked file.

Del Song

Touch this button to delete the current entry.

Write

Touch this button to open the Write Song dialog box, and save the current entry to the main list of the SongBook.

Note: The maximum number of entries in a SongBook file is 3,000 entries.



To assign a different name to the entry, touch the **T** (Text Edit) button to open the Text Edit window.

Select an option to add the new entry to the SongBook:

- Select **Rename/Overwrite** to overwrite an existing entry, optionally changing its name. **Warning:** The older entry will be deleted!
- Select **New Song** to save a new entry to the SongBook database.

Book Edit 2

The Book Edit 2 page is where you enter information on the Genre, Artist, Key, etc. to the SongBook Entry.

The Book Edit 2 page with a Style-based entry:

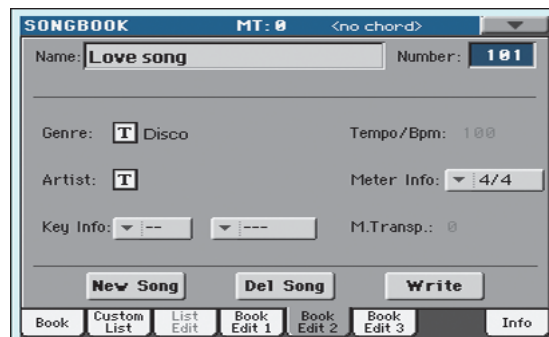

The Book Edit 2 page with a Song-based entry:

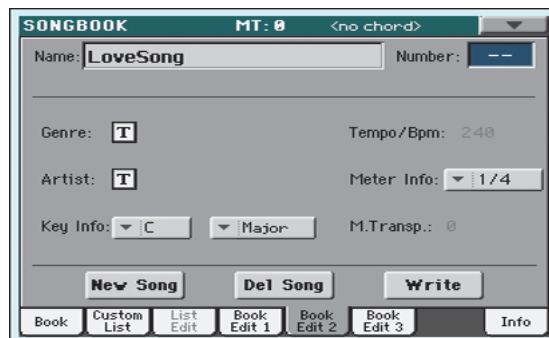

Header

This includes the same Name, Number and Entry Resource fields found in the “Book Edit 1” page (see above).

Database

Genre

Music genre associated with the entry.

Artist

Name of the artist of the song associated with the entry.

Key Info

Original key of the entry. The first field is the key name, the second one is the mode (major or minor).

Tempo/BPM

Basic tempo of the Style, or starting tempo of the Standard MIDI File associated with the entry. This may change, if a Tempo Change event is included with the associated resource.

You can change this value by using the TEMPO buttons on the control panel. Any change will be shown after saving the Entry.

Note: The starting value of a Standard MIDI File is always considered, and overrides this value.

Note: You can edit this value even if an MP3 is associated to the SongBook Entry. However, this is just an indicative value.

Meter Info

Basic meter (time signature) of the Style, or starting meter of the Standard MIDI File associated with the entry. This may change, if a Meter Change event is included with the associated resource.

M.Transp. (Master Transpose)

Master Transpose. When the entry is selected, the Master Transpose of the whole instrument is automatically changed. The Master Transpose value saved in the SongBook Entry overrides any Master Transpose setting contained in the referenced Song.

You can change this value by using the TRANSPOSE buttons on the control panel. Any change will be shown after saving the Entry.

Note: If the Master Transpose is locked (Global > General Controls > Lock), the Master Transpose will not change.

Book Edit 3

This page is where you select the Synchro and Memory options to be memorized, link a “.TXT” file.

The Book Edit 3 page with a Style-based entry:



The Book Edit 3 page with a Song-based entry:



Synchro Start / Synchro Stop / Memory

The status of these functions can be memorized in a SongBook Entry.

Note: If the SongBook Entry is based on a Song, Synchro Start and Synchro Stop are greyed out and cannot be modified, since they have no effect on a Song.

- Unchanged When selecting this SongBook Entry, the status of the corresponding function is left unchanged.
- Off When selecting this SongBook Entry, the status of the corresponding function is turned off.
- On When selecting this SongBook Entry, the status of the corresponding function is turned on.

Linked .TXT

You can select a text (.TXT) file, and link it to the Style or Song associated with the current SongBook Entry. When you select this entry, the text file will be automatically loaded.

Text files can be seen on the display. Since there is no automatic synchronization between this kind of lyrics and the associated songs, you must scroll them manually. This can be accomplished in either of two ways:

- When a “.TXT” file is selected, a special vertical scrollbar appears in the “Lyrics” page. Touch it to scroll through the text during the performance. See the “Lyrics, Score, Markers” chapter on page 304.
- Scrolling is also possible by means of the Text Page Down/Up command, that can be assigned to a Footswitch or Assignable Switch.

This section of the Book Edit 3 page contains two buttons:

- Reset Touch this buttons to unlink the text file from the entry.
- Browse Touch this button to open a standard File Selector, and select a “.TXT” file to be linked to the current SongBook Entry.

After selection, the name of the linked text file appears above the two buttons.

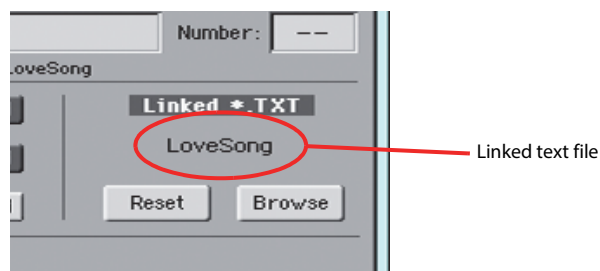

Info

Use the Info page to see the name of the selected entry, the associated resource(s), the total number of Songs in the SongBook, the number of filtered entries, the number of available Custom Lists, and the number of Songs in the current list.

- In case of an entry based on a Style:

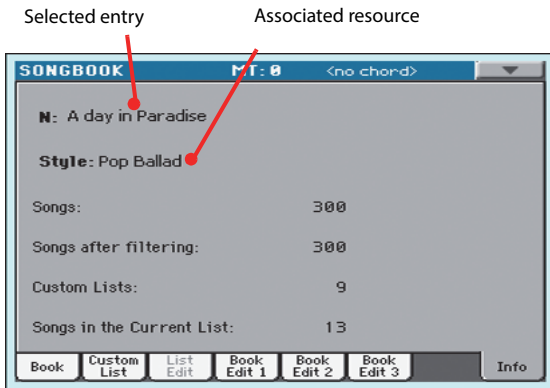

- In case of an entry based on a Song in Standard MIDI File or MP3 format:

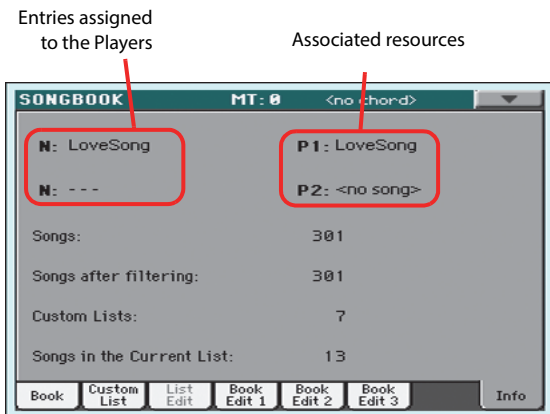

Selected entry

This parameter shows the currently selected entry. If it is blank (---), the latest selected entry has been modified, or no entry has been selected.

Associated resource

Style, Standard MIDI File or MP3 file associated to the selected entry.

Songs

Total number of entries in the SongBook list.

Songs after filtering

This parameter shows the number of entries shown in the “Book” page, after applying the selected filter. If no filter is selected, this matches the total number of entries in the SongBook list (see previous parameter).

Custom Lists

This parameter shows the number of available Custom Lists.

Songs in the Current List

Number of entries in the selected Custom List.

Page menu

Touch the page menu icon to open the menu. Touch a command to select it. Touch anywhere in the display to close the menu without selecting a command.

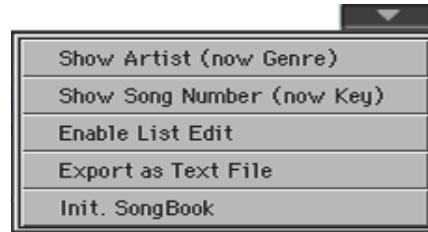

Show Artist/Genre

Select this command to toggle between the Artist and Genre column on the SongBook list, appearing in the “Book” and “Custom List” pages.

Show Number/Key

Select this command to toggle between the Number and Key column on the SongBook list, appearing in the “Book” and “Custom List” pages.

Enable List Edit

Select this command, and make the checkmark appear, to make the List Edit page available.

Export as text file

Only available when the Book or Custom List pages are selected. Select this command to open the Export dialog box, and save the SongBook or Custom List as a text file. The selected filtering will be applied to the exported list, assuming the Filter button is checked.

The dialog box is a little different, depending on the page where you selected this command.

- Selected from the “Book” page:

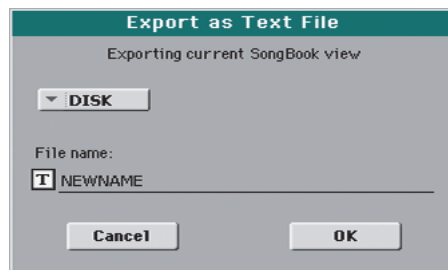

- Selected from the “Custom List” page:

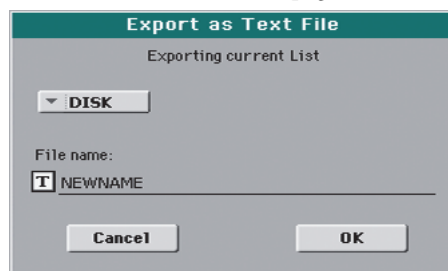

Touch the **T** (Text Edit) button to open the Text Edit window and assign a name to the text file to be saved to a storage device. Then, select either the internal storage memory to save the file.

- Touch OK to confirm.

Init SongBook

Select this command to erase the SongBook list and start with a new, blank list.

Warning: *Before initializing the SongBook list, save the older one with one of the Media > Save operations.*

Lyrics, Score, Markers

By pressing the LYRICS button, you can see lyrics in Style Play mode, lyrics and chord abbreviations in Style Play and Song Play modes. The SCORE button will let you see a traditional score in the Song Play mode. Pressing both MARKER buttons will give you access to the markers in the Song Play mode.

Selected Player

You can always use the Player 1 and Player 2 buttons in the top right corner of the display to select a Player whose Song to show. Player 1 is orange, while Player 2 is blue.

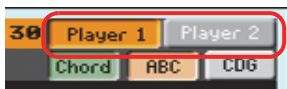

When moving the X-FADER, the shown score may change. When the X-FADER is fully moved to the left, the score for Player 1 is shown; when the X-FADER is fully moved to the right, the score for Player 2 is shown instead.

Note: You can have Player 2 selected in the Main page of the Song Play mode, and Player 1 selected in the Lyrics page, or vice-versa. This way, you can select a Song whose lyrics, score or markers to display on the external video monitor, while selecting a different player for editing operations.

Lyrics page

Open the Lyrics page by pressing the LYRICS button. This page shows the lyrics in Style Play mode, lyrics and chord abbreviations in the Song Play mode.

Viewing lyrics and chords with Songs

You can see the following types of lyrics and chords:

- Lyrics contained in a Standard MIDI File or Karaoke™ file as Lyrics events, or in an MP3 file with Lyrics (in ID3 format – see www.id3.org).
- Lyrics contained in a “.CDG” file, loaded with an MP3 file with the same name. When a “.CDG” file exists in the same directory as an MP3 file, and shares exactly the same name, it will be loaded with the “.MP3” file.
- Lyrics contained in a “.TXT” file, loaded with a Standard MIDI File, Karaoke or MP3 file with the same name. When a “.TXT” file exists in the same directory as a Standard MIDI File or MP3 file, and shares exactly the same name, it is loaded with the “.MID” or “.MP3” file (see “Text files loaded with Standard MIDI Files and MP3 files” on page 305).
- Lyrics contained in a “.TXT” file linked to the latest-selected SongBook Entry (see “Linked .TXT” on page 301).
- When no lyrics data is contained in the Song, or linked to a SongBook Entry, you can see lyrics contained in a “.TXT”

file loaded at any time after selecting a Song (see “On-the-fly TXT loading” below).

This is the priority of lyrics data shown in the display:

- CDG file contained in the same folder as the MP3 file, *overriding...*
- TXT file linked to a SongBook Entry, *overriding...*
- TXT file contained in the same folder as the Standard MIDI File or MP3 file, recalled by a SongBook Entry, *overriding...*
- Lyrics events contained in the Standard MIDI File or MP3 file.

Hint: If you do not want to see the TXT file or the CDG file, and prefer to see the Lyrics data, rename or delete the TXT or CDG file, or move it to a different folder.

Viewing lyrics with the Styles

Lyrics can be associated to a Style as a “.TXT” file. When in this page, you can see:

- Lyrics contained in a “.TXT” file linked to the latest-selected Style-based SongBook Entry (see “Linked .TXT” on page 301).
- Lyrics contained in a “.TXT” file loaded after selecting a Style (see “On-the-fly TXT loading” below).

The Lyrics page in detail

Lyrics will be shown only if they are compatible with a standard format that Pa900 can understand.

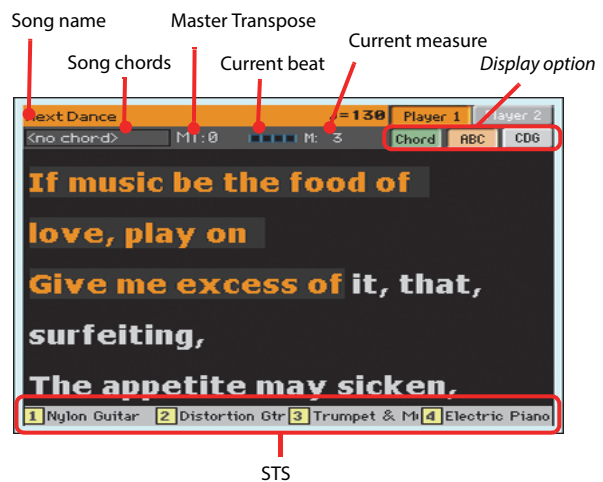

While the Song is playing, Lyrics contained in a Standard MIDI File or MP3 file scroll in the display. Chord abbreviations (if any) will appear above the lyrics, in time with the music (depending on the status of the “Chord” button). Lyrics at the current position are highlighted.

If the text has been loaded as a “.TXT” file, it will not scroll automatically while the Song is playing back. You must scroll it with the VALUE DIAL or the vertical scrollbar. As an alternative, you can use an assignable switch or footswitch, with the Text Page Up or Text Page Down functions assigned, to scroll (respectively) to the previous or next text page.

To exit from this page, press either the LYRICS or the EXIT button.

Song chords

Chords contained in the Standard MIDI File (if any). This indicator may be easier to read than chords shown within the lyrics.

When changing the Master Transpose, chord abbreviations contained in a Standard MIDI File are transposed, and correctly shown in the display. Master Transpose must be activated on the Player, but not on the Keyboard.

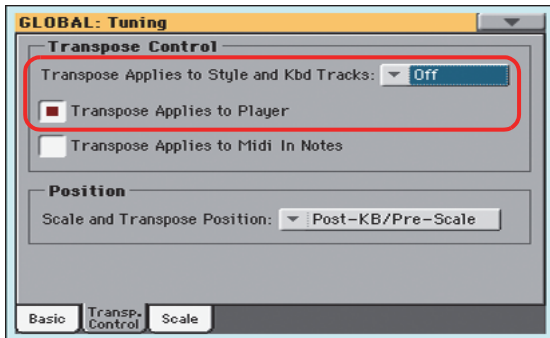

Master Transpose

Master transpose value in semitones. This value can be changed using the TRANSPOSE buttons on the control panel.

Current beat

Standard MIDI Files only. Currently playing beat.

Current measure

Standard MIDI Files only. Current measure number.

STS

Name of the four selected Single Touch Settings (STS). Touch one of them to select it.

Chord

If this button is depressed, chords are shown above lyrics in the display – provided the Standard MIDI File contains them.

ABC

Size of the fonts. You can choose between a smaller and a bigger font.

CGD

Touch this button to show the lyrics contained in the associated CDG file.

Text in MP3+CGD files

When a “.CDG” file with the same name exists in the same directory as an MP3 file, it will be loaded with the “MP3” file, and can be seen in the Lyrics page.

As an example, if the file “MYSONG.CDG” exists in the same directory as the “MYSONG.MP3” file, it is loaded together with the matching “.MP3” file.

Text will scroll automatically while the Song is playing back.

Note: When a “.CDG” file is loaded with the Song, it overrides any included Lyrics data.

Text files loaded with Standard MIDI Files and MP3 files

When a “.TXT” file with the same name exists in the same directory as a Standard MIDI File or MP3 file, it will be loaded with the “.MID” or “.MP3” file, and can be seen in the Lyrics page.

As an example, if the file “MYSONG.TXT” exists in the same directory as the “MYSONG.MID” or “MYSONG.MP3” file, it is loaded together with the matching “.MID” or “.MP3” file.

However, unlike ordinary Lyrics, the text will not scroll automatically while the Song is playing back. You must scroll it with the scrollbar or the VALUE DIAL. As an alternative, you can use an assignable switch or footswitch, with the Text Page Up or Text Page Down functions assigned, to scroll (respectively) to the previous or next text page.

Text files must be formatted with non-proportional fonts (like Courier, Courier New, Monaco, or any other “monospaced” font). Up to 24 characters can fit a single line of text when using the bigger font size, 41 when using the smaller font size (see “ABC” above).

Note: When a “.TXT” file is loaded with the Song, it overrides any included Lyrics data.

On-the-fly TXT loading

When a Song does not contain any Lyrics metadata or isn't linked to any “.TXT” file, the “No lyrics. Press SHIFT and touch here to load a TXT file” message appears in the display when you press the LYRICS button.

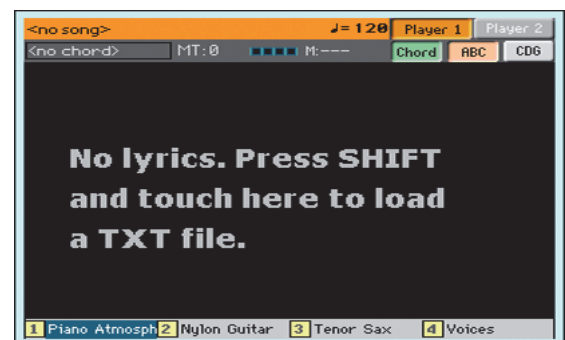

The same happens while in Style Play mode.

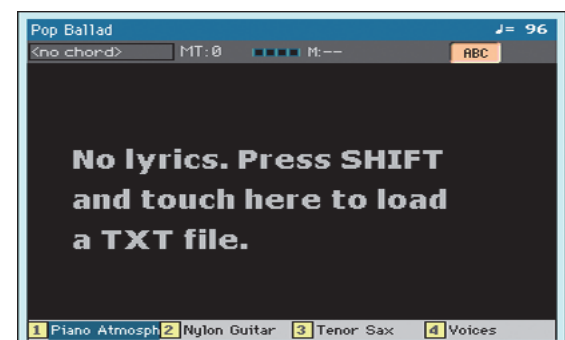

When this message appears, and you want to load a “.TXT” file, keep the SHIFT button pressed and touch the center of the display. A standard file selector will appear, and will let you look for a “.TXT” file to be loaded.

Hint: You can use the Search function to search a “.TXT” file in the various storage devices. See the relevant chapter.

Score page

When you are in Song Play mode, and you are playing a Standard MIDI File, you can open the Score page by pressing the SCORE button.

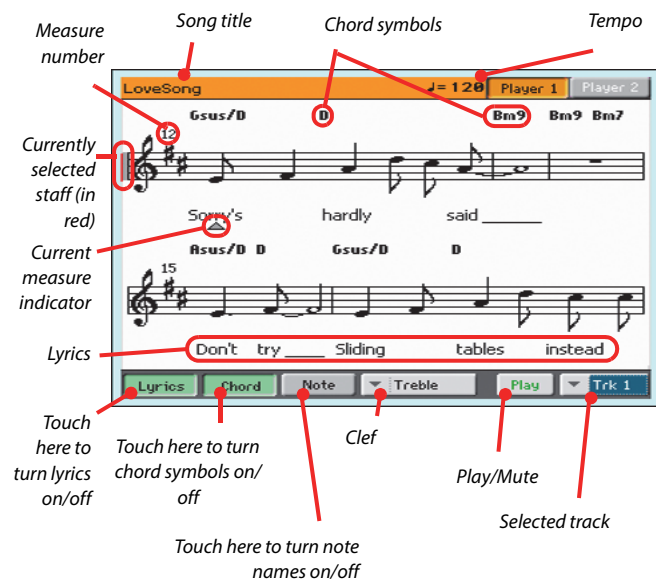

To exit from this page, press either the SCORE or the EXIT button.

Note: Master or Track Transpose do not affect the Score display.

Song title

Name of the Song.

Tempo

Current Tempo of the Song (in BPM, Beats Per Minute).

Staff

The selected track is shown as traditional music notation. Depending on the content of the track, either notes or chords are shown. Pa900 takes care for you of 'cleaning-up' the score, so that it is always easy to read.

Several automatic operations are carried on to clean-up the score: Pa900 automatically quantizes to 1/16 notes, detects triplets, avoids note overlaps, correctly notates syncopation, and draws beams according to the time signature. In addition, spacing and measure length are dynamic, and single, double and end measure bars are automatically added.

If a KeySign (Key Signature) event is found at position '001.01.000' of the Song's Master track, the correct key signature is also shown.

Currently selected staff marker

This red vertical line shows the approximate position of the playback, by indicating the current staff in play.

Current measure indicator

This red triangle shows the current measure in play.

Lyrics button

Touch this button to make the lyrics (if available) appear or disappear.

Chord button

Touch this button to make the chord symbols (if available) appear or disappear. Chords are shown either according to the English or Italian system, depending on the selected language (see "General Controls: Interface" on page 248).

Note button

Touch this button to make the note name appear or disappear next to each note. Note names are shown either according to the English or Italian system, depending on the selected language (see "General Controls: Interface" on page 248).

Clef

Touch here to open a pop-up menu, where to choose a clef from. Available clefs are:

Treble	Standard Treble clef (♩).
Treble+8	Treble clef with transposition one octave upper.
Treble-8	Treble clef with transposition one octave lower.
Bass	Standard Bass clef (♭).
Bass-8	Bass clef with transposition one octave lower.

Play/Mute

Use this button to let the selected track play, or to mute it. If the track is muted, the score is still shown, so that you can play or sing it.

Hint: The "Melody Mute" function, that can be assigned to an assignable switch or footswitch, allows for muting the melody track of a Song (default: Track 4, see "SMF Melody Track" on page 253). If your song has the melody part assigned to the same track, you can mute or unmute it by using this button, or the assigned switch/pedal.

Selected track

Touch here to open a pop-up menu where to chose the track to be shown from.

Hint: The backing vocals are often assigned to Track 5.

Markers page

Open the Marker page by pressing both the MARKER (that is, LYRICS+SCORE) buttons. This page shows the Song Markers in the Song Play mode and in the SongBook.

Standard Song Markers contained in a Standard MIDI File can be read with the Pa900, to quickly jump to a given position in the Song. Additionally, you can set your own marker points on-the-fly.

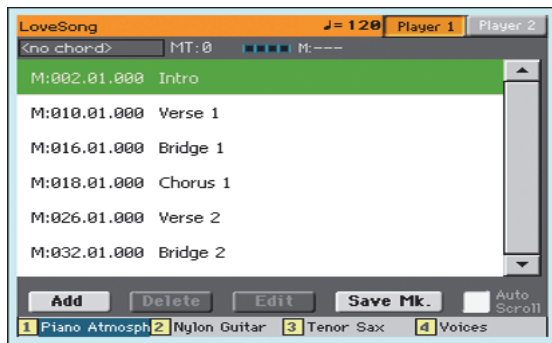

To exit from this page, press the EXIT button.

How to add a marker:

1. Press the MARKER button to open the Markers page.
2. Start the Song by pressing the PLAY/STOP button (however, markers can be added even while the player is not running).
3. When you reach the position you want to save as a marker, touch the Add button in the display.
 - If you touch Add within the first beats of the measure, the beginning of the current measure is saved as a marker.
 - If you touch Add within the last beat of the measure, the beginning of the following measure is saved as a marker.
4. Do the same for any following marker.
5. Stop the Song by pressing the PLAY/STOP button.

How to jump to a saved marker:

1. If you like, start the Song again.
2. When you want to jump to a saved marker (while the Song is stopped or playing), touch it in the display. The Song will jump to the saved position at the beginning of the next measure.

How to edit a marker:

1. Touch the marker to be edited in the display.
2. Touch the Edit button in the display to set the marker to edit. The Edit Marker window will appear.

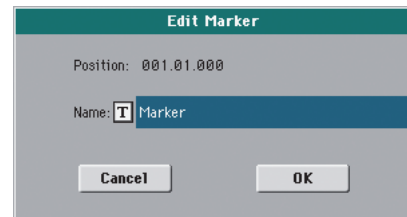

3. While in Edit Marker window, you can edit the name and position of the marker being edited.
4. Save the markers (as described below).

How to delete a marker:

1. Touch the marker to be deleted in the display.
2. Touch the Delete button in the display to delete the selected marker.
3. Save the markers (as described below).

How to save the markers:

Touch the “Save Mk” button in the display to save all markers.

If you are not in the Lyrics/Score page, choose the “Save Song Marker” command from the page menu. The markers will be saved into the Standard MIDI File.

Auto Scroll

Check this parameter if you want the current marker to be always visible in the display during playback, by making the list of markers scroll automatically.

Don't check this parameter, if you prefer to prevent the list from scrolling. This is useful if you want a marker to remain in the display, ready to be selected as soon as you want to jump to its position, with no need to scroll the list to catch it out.

STS

Name of the four selected Single Touch Settings (STS). Touch one of them to select it.

MIDI

What is MIDI?

Here is a brief overview of MIDI, as related to the Pa900. If interested, you may find more information on the general use of MIDI in the various specialized magazines and dedicated books.

In general

MIDI stands for Musical Instruments Digital Interface. This interface lets you connect two musical instruments, or a computer and various musical instruments.

From a software point of view, MIDI is a protocol that describes messages for playing notes and controlling them. It is sort of a grammar to let different instruments and computers speak the same language, and let the one tell the other what to do.

From a physical point of view, MIDI messages can travel across two different types of connectors on the Pa900:

- The MIDI interface, that is composed of two different connectors. The MIDI IN receives data from another device; the MIDI OUT sends data to another device.
- The USB Device port, that replaces both the MIDI IN and OUT connectors with a single port and cable. To use it for MIDI connection, it is advisable to install the KORG USB-MIDI Driver supplied in the Accessory Disc, or downloadable from our web site (www.korg.com).

Both these devices are active at the same time. So, you can connect the Pa900 to a computer via the USB port, and connect another instrument's MIDI IN port to the MIDI THRU port of the Pa900.

Channels and messages

Basically, a MIDI or USB cable transmits 16 channels of data. Think to each MIDI channel as a TV channel: the receiver must be set on the same channel of the transmitter. The same happens with MIDI messages: when you send a Note On message on channel 1, it will be received on channel 1 only. This allows for multitimbricity: you can have more than one sound playing on the same MIDI instrument.

There are various messages, but here are the most commonly used:

Note On – This message instructs an instrument to play a note on a specific channel. Notes have both a name (C4 standing for the center C) and a number (60 being the equivalent for C4). A Note Off message is often used to say the note has been released. In some case, a Note On with value “0” is used instead.

Together with the Note On message, a Velocity value is always sent. This value tells the instrument how loud the note must play.

Pitch Bend (PB) – You can generate this message acting on the joystick (X direction). The pitch is translated up or down.

Program Change (PC) – When you select a Sound, a Program Change message is generated on the channel. Use this message,

together with Control Change 00 and 32, to remotely select Pa900 data from a sequencer or a master keyboard.

Control Change (CC) – This is a wide array of messages, controlling most of the instrument parameters. Some examples:

- CC00, or Bank Select MSB, and CC32, or Bank Select LSB. This message pair is used to select a Sound Bank. Together with the Program Change message, they are used to select a Sound.
- CC01, or Modulation. This is the equivalent of pressing up the joystick. A vibrato effect is usually triggered on.
- CC07, or Master Volume. Use this controller to set the channel's volume.
- CC10, or Pan. This one sets the channel's position on the stereo front.
- CC11, or Expression. Use this controller to set the relative volume of tracks, with the maximum value matching the current setting of the CC07 control.
- CC64, or Damper Pedal. Use this controller to simulate the Damper pedal.

Tempo

Tempo is a global MIDI message, that is not tied to a particular channel. Each Song includes Tempo data.

Lyrics

Lyrics are non-standard MIDI events, intended to display text together with the music. Pa900 can read many of the available Lyrics format on the market.

What is MIDI Over USB?

You can let the Pa900 communicate MIDI data with a computer using the USB Device port instead of the MIDI ports. This way, you can connect your Pa900 to a personal computer without the need of a dedicated MIDI interface.

Most Pa900 MIDI features can be used on a Windows or Mac computer with no need of special software. However, for full and easy use of all MIDI features, we suggest you to install the “KORG USB MIDI Driver”, a special software that you can find in the Accessory Disc that comes with your Pa900. Relevant instructions come with the software itself. See “Installing the Korg USB MIDI Driver” on page 428.

Standard MIDI Files

Standard MIDI Files (a.k.a. SMF) are a practical way of exchanging songs between different instruments and computers. Pa900 uses the SMF format as its default song format, so reading a song from a computer, or saving a song that a computer software can read, is not a problem at all.

The internal Players are compatible with SMFs format 0 (all data in one track; it is the most common format) and 1 (multitrack). Pa900 can read SMFs in Song Play mode and modify/save them in Sequencer mode. It can save a Song in SMF format 0 from Sequencer mode.

When in Song Play mode, Pa900 can also display SMF lyrics in Solton, M-Live (Midisoft), Tune1000, Edirol, GMX, HitBit, and XF formats, and the chord abbreviations of SMF in Solton, M-Live (Midisoft), GMX, and XF format.

Note: The above trademarks are the property of their respective holders. No endorsement is intended by their inclusion in this list.

Standard MIDI Files usually have the “.MID” or “.KAR” filename extension.

The General MIDI standard

Some years ago, the musical instruments world felt a need for some further standardization. Then, the General MIDI Standard (GM) was born. This extension of the basic MIDI sets new rules for compatibility between instruments:

- A minimum of 16 MIDI channels was required.
- A basic set of 128 Sounds, correctly ordered, was mandatory.
- The Drum Kit had a standard order.
- Channel 10 had to be devoted to the Drum Kit.

A most recent extension is the GM2, that further expands the Sounds database. Pa900 is sound-compatible with the GM2 standard.

The Global channel

Any channels with the Global option assigned (see “MIDI: MIDI In Channels” on page 260) can simulate the Pa900 integrated keyboard. When the Pa900 is connected to a master keyboard, transmission should take place over the Global channel of the Pa900.

The MIDI messages received over a Global channel and not over a standard channel are affected by the status of the SPLIT button, as well from the split point. Therefore, if the SPLIT button LED is lit up, notes arriving to Pa900 over this channel will be divided by the split point into the Upper (above the split point) and Lower (below the split point) parts.

Notes arriving to a Global channel are used for the chord recognition of the automatic accompaniment. If the SPLIT LED is turned on, only the notes below the split point will be used.

These notes will be combined with the ones of the special Chord 1 and Chord 2 channels.

The Chord 1 and Chord 2 channels

You can set two special Chord channels (see page 260) to send Pa900 notes for chord recognition. These notes will be combined with the notes that go through the channel set as Global (Global notes are recognized only under the split point, if the SPLIT LED is lit up).

The Chord channels are not affected by the split point. All the notes – both above and below the split point – will be sent to the chord recognition.

However, the status of the SPLIT button has a particular effect on the way chords are recognized on the Chord channels:

- When the SPLIT LED is turned on (Lower mode), the chord recognition mode will be set by the “Chord Recognition” parameter in the Global > Mode Preferences > Style page (see page 252). You can play a single note to play a Major chord.
- When the SPLIT LED is turned off (Full Upper mode), the chord recognition mode will always be Fingered or Expert, depending on the previous situation. You have to play at least three notes in order for the chord to be detected.

These two channels are especially useful for accordion players, that wish to assign a different Chord channel to the chords and the bass played with the left hand. This way, chords and bass will both contribute to the formation of chords for the chord recognition of the automatic accompaniment.

The Control channel

You can set a MIDI IN channel as the Control channel (see page 260), to select Styles and Performance from an external device. See the Appendix for a list of messages corresponding to Pa900 internal data.

MIDI Presets

You can play Pa900 with an external controller, and use it simply as a powerful sound generator. To help you configure the MIDI channels, we have provided a set of MIDI Presets that can be accessed in the Global > MIDI > General Controls page (see “Preset” on page 258).

We recommend you to consider each MIDI Preset as a starting point you can freely tweak. Once you have selected the most appropriate MIDI Preset for the connection to be made, you can modify the parameters as needed and save them into a MIDI Preset (see “Write Midi Preset dialog box” on page 275).

Connecting Pa900 to a Master keyboard

You can control Pa900 with a master keyboard or any other MIDI keyboard. You only need to connect the MIDI OUT connector of the master keyboard to the MIDI IN connector of Pa900. The master keyboard will become the integrated keyboard of the Pa900 if it transmits over the same channel programmed as Global in Pa900.

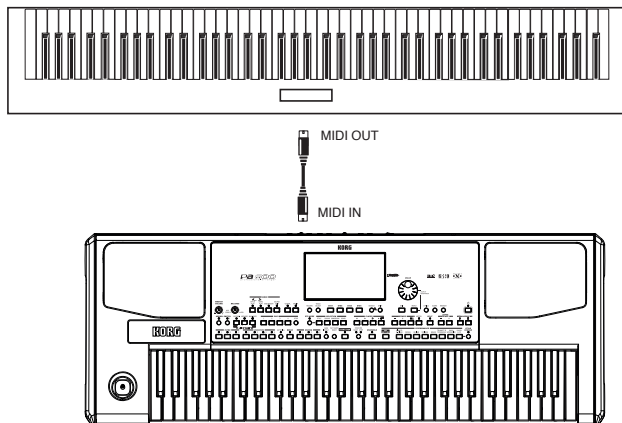

If the master keyboard transmits over the Global channel of Pa900, the split point and the status of the SPLIT button in the control panel will affect the notes received from the master keyboard.

Connections and settings

To connect the master keyboard to Pa900 follow this procedure:

1. Connect the MIDI OUT connector of the master keyboard to the MIDI IN connector of the Pa900.
2. Program the master keyboard to transmit over the Global channel of Pa900 (see “MIDI: MIDI In Channels” on page 260).

For information on programming the master keyboard, please see the master keyboard's own user manual.

3. Select the “Master Keyboard” MIDI Preset. You can do this by going to the “MIDI: General Controls” page of the Global mode. Note that this MIDI Preset will be remain unchanged even when the instrument enters standby.

Note: Settings may change when new Global data is loaded from disk. To protect settings from loading, use the Global Protect function (see “Global Protect” on page 254).

4. If needed, press one of the buttons in the MODE section to go to the desired operative mode.

Connecting Pa900 to a MIDI accordion

There are various types of MIDI accordions, each one requiring different MIDI settings. Pa900 is provided with a series of “Accordion” MIDI Setups, each one suitable for a different MIDI accordion (see page 258).

Connection and settings

To connect the accordion to the Pa900 follow this procedure:

1. Connect the MIDI OUT connector of the accordion to the MIDI IN connector of Pa900.
 2. Select one of the available “Accordion” MIDI Preset parameter. You can do this by going to the “MIDI: General Controls” page of the Global mode. Note that this MIDI Preset will be remain unchanged even when the instrument enters standby.
- Note: Settings may change when new Global data is loaded from disk. To protect settings from loading, use the Global Protect function (see “Global Protect” on page 254).*
3. If needed, press one of the buttons in the MODE section to go to the desired operative mode.

Connecting Pa900 to an external sequencer

You can program a new song on an external sequencer, using Pa900 as a multi-timbral expander.

Connections and settings

In order to connect Pa900 to a computer, you need a computer with either a MIDI interface or a USB port.

1. In case of an USB connection, install the Korg USB MIDI Driver, as explained in “Installing the Korg USB MIDI Driver” on page 428.
2. Connect Pa900 and the computer either via the USB Device port, or via the MIDI ports and a MIDI interface, as shown in the following diagram.

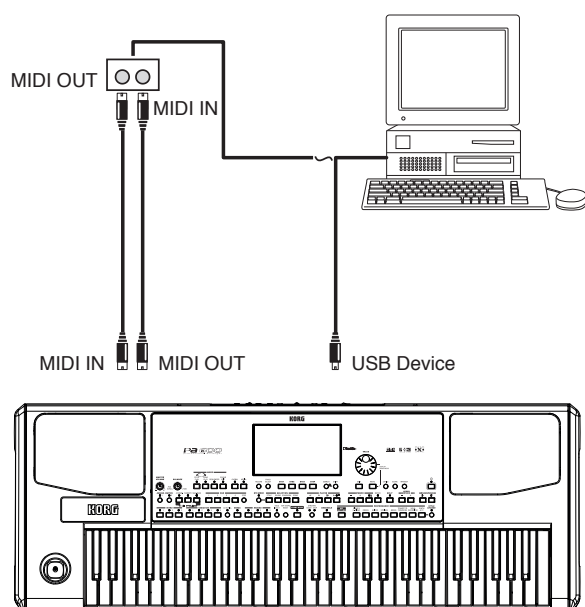

3. Activate the “MIDI Thru” function on the external sequencer. Please refer to the sequencer’s user manual.
4. On Pa900, select the “Extern.Seq.” MIDI Preset. You can do this by going to the “MIDI: General Controls” page of the Global mode. Note that this MIDI Preset will remain unchanged even when the instrument enters standby.
5. Go to the “MIDI: General Controls” page, and uncheck the “Local Control On” parameter (see page 259). This is called the “Local Off status”.

Note: Settings may change when new Global data is loaded from disk. To protect settings from loading, use the Global Protect function (see “Global Protect” on page 254).

6. Press SEQUENCER to go to the Sequencer mode.
7. Play the keyboard. Notes played on the keyboard will go from the MIDI OUT of Pa900 to the MIDI IN of the computer/MIDI interface (or from the USB port of Pa900 to the USB port of the computer).

Notes generated by the computer (i.e. a song played by its sequencer) are sent through the MIDI OUT of the MIDI interface to the MIDI IN connector of Pa900 (or from the USB port of the computer to the USB port of Pa900).

The Local Off

When Pa900 is connected to an external sequencer, we recommend you to set the Pa900 in Local Off mode (see “Local Control On” on page 259) to avoid that the notes are simultaneously played by the keyboard and by the MIDI events sent by the external sequencer.

When Pa900 is in Local Off, the keyboard of Pa900 transmits data to the external sequencer, but not to the internal sound generation. The sequencer will receive notes played on the keyboard of Pa900 and will send them to the selected track of the song. The track will then transmit data to the internal sound generation of Pa900.

Note: In order to send data to the sound generation of Pa900, the “MIDI Thru” function must be activated in the external sequencer (normally active; the name may be different according to the type of sequencer). For more information refer to the instructions manual of the sequencer.

The Sounds

The song that is played back by the sequencer can select Pa900 Sounds through the MIDI messages Bank Select MSB, Bank Select LSB (bank selection, two messages), and Program Change (Sound selection). For a list of Sounds and MIDI values, see “Sounds” on page 318.

A suggestion for those who program songs on computer: even though it is not mandatory, for a wider compatibility you should set the bass on channel 2, melody on channel 4, drum kit on channel 10, controls for an harmonizer on channel 5.

Playing another instrument with Pa900

You can use Pa900 as the master controller for your MIDI setup.

1. Connect the MIDI OUT connector of Pa900 to the other instrument's MIDI IN.
2. Set the other instrument to the same channels you want to play from Pa900. For example, if you wish to play the Upper 1 and Upper 2 tracks with sounds of the other instrument, enable the other instrument to receive on the same channels Pa900 is transmitting from the Upper 1 and Upper 2 tracks (by default, channels 1 and 2).
3. Set the master volume of the other instrument with its own volume controls.
4. Mute/unmute any track right from the Pa900. Adjust each track's volume by using the Pa900 (sliders on the display).
5. Play the keyboard of Pa900.

The Keyboard

The keyboard of Pa900 can drive up to four tracks via the MIDI OUT (Upper 1-3 and Lower). MIDI output channels are set in Global mode (see "MIDI: MIDI Out Channels" on page 261).

As per the default situation ("1-Default" MIDI Preset), each of Pa900 Keyboard tracks transmit on the following channels:

Track	Out Channel
Upper1	1
Upper2	2
Upper3	3
Lower	4

When a track is muted, it cannot transmit any MIDI data to an external expander or sequencer connected to the MIDI OUT of Pa900.

To only hear the expander's sounds, you can lower the MASTER VOLUME control on the Pa900, or set the Keyboard tracks to the External status (see "Track Controls: Mode" on page 192).

The Player

Any Player's track can drive a channel on an external instrument. To set each track's MIDI output channel, see "MIDI: MIDI Out Channels" on page 261.

To only hear the expander's sounds, you can lower the MASTER VOLUME control on the Pa900, or set the Song tracks to the External status (see "Track Controls: Mode" on page 192).

Select the "Player" MIDI Preset to set the channels as follows:

Track	Out Channel
Song 1...16	1...16

The Arranger

One of the most interesting aspect of MIDI, is that you can use your Pa900 to play an external instrument with its onboard arranger. Yes, it's hard to beat the audio quality of Pa900, but you could wish to use that old faithful synth you are still accustomed to...

To assign some of the Style tracks of Pa900 to an external instrument, set them to the External status (see "Track Controls: Mode" on page 192).

Select the "Default" MIDI Preset to set the channels as follows (this is the default status of Pa900):

Track	Out Channel
Bass	9
Drums	10
Percussion	11
Acc1...5	12...16

Appendix

Factory data

Styles

This list shows the Styles and their position number inside the bank.

#	Name
Bank: Pop	
1	70's Guitar Pop
2	Shadow Pop
3	Retro Beat
4	Pop Evergreen
5	Pop Hit
6	Pop Beat
7	Standard 8 Beat
8	Standard 16 Beat
9	Guitar Pop
10	Guitar Beat
11	Modern Beat
12	Pop Ballad
13	Pop Chart 1
14	Pop Chart 2
15	Easy Pop 1
16	Easy Pop 2
17	British Pop
18	Slow Latin Pop
19	6/8 Slow Pop
20	12/8 Pop
21	Pop Shuffle 1
22	Pop Shuffle 2
23	Easy Beat 1
24	Easy Beat 2
25	Real 8 Beat
26	Real 16 Beat
27	Soft 8 Beat
28	Soft 16 Beat
29	Analog Beat 1
30	Analog Beat 2
31	8 Beat Analog 1
32	8 Beat Analog 2
33	Pop Funk 1
34	Pop Funk 2
Bank: Ballad	
1	Modern Ballad 1
2	Modern Ballad 2
3	Moonlight Ballad
4	Soft Ballad
5	Piano Ballad
6	70's Ballad
7	Easy Ballad

#	Name
8	Organ Ballad
9	Folk Ballad
10	Orchestral Bld
11	Funky Ballad
12	Blues Ballad
13	Analog Ballad 1
14	Analog Ballad 2
15	Rock Ballad 1
16	Rock Ballad 2
17	Waltz Ballad
18	6/8 Slow
19	6/8 Ballad
20	6/8 Brush Bld
21	Pop Hit Ballad
22	Oriental Ballad
23	Blue Ballad
24	Groove Ballad
Bank: Ballroom	
1	Quick Step
2	Paso Dance
3	Jive 1
4	Jive 2
5	Argentina Tango
6	Modern Tango
7	Slow Fox
8	Organ Foxtrot
9	Slow Waltz 1
10	Slow Waltz 2
11	Slow Waltz 3
12	Organ Waltz
13	Foxtrot 1
14	Foxtrot 2
15	Slow Band
16	Big Band Jump
17	Big Band Fox
18	Big Band 40's
19	Fox Shuffle 1
20	Fox Shuffle 2
21	Italian Tango 1
22	Italian Tango 2
23	Twist
24	Hully Gully
25	50's Fox
26	Italian Fox
27	Irish Fox
28	Easy Listening

#	Name
Bank: Dance	
1	70's Disco Remix
2	70's Disco 1
3	70's Disco 2
4	80's Dance
5	90's Dance
6	Electro Dance
7	Dance Chart 1
8	Dance Chart 2
9	Funky Disco
10	Techno
11	Garage
12	House
13	Club House
14	Club Remix
15	Fashion Funk
16	Dance Fever
17	Barry Dance
18	Sister & Girl
19	Philly Disco
20	Miami Disco
21	Love Disco
22	Dance Motown
23	Dance Mix
24	Soca Dancing
25	Disco Gully
26	Disco Latin
27	Oriental Dance
28	HipHop
29	Euro Trance
Bank: Rock	
1	80's Rock
2	Rock Punch
3	Clean Rock
4	Rolling Rock
5	Johnny Rock
6	Rock the Clock
7	Pop Rock
8	English Rock
9	Fire Rock
10	Hard Rock
11	Open Rock 1
12	Open Rock 2
13	Heavy Rock
14	Funky Rock
15	Rock Oldie

#	Name
16	Rock & Roll
17	South Shuffle
18	Slow Latin Rock
19	Latin Rock 1
20	Latin Rock 2
21	Surf Rock
22	60's Rock
23	Slow Rock 1
24	Slow Rock 2
25	60's Slow Rock
26	6/8 Rock
27	Steely Rock
28	Abbey Rock
29	SouthStrait Rock
30	Rock Cha Cha
Bank: Unplugged	
1	Unplugged Heaven
2	Sally Groove
3	Unplugged Ballad 1
4	Unplugged Ballad 2
5	Unplugged Ballad 3
6	Unplugged Slow
7	Acoustic Rock
8	Serenade
9	Unplugged
10	Unplugged Reggae
11	Unplugged 8 Bt
12	Unplugged 16 Bt
13	Unplugged Gtr 1
14	Unplugged Gtr 2
15	Unplugged Gtr 3
16	Unplugged Gtr 4
17	Slide Blues
18	Unplugged Rock
19	Unplugged Latin
20	Unplugged Swing
21	¾ Unplugged
22	¾ Acoustic Bld
23	Desert Shuffle
24	Meditando
Bank: Country	
1	Easy Country
2	Country Blues
3	Country Strum
4	Country QuikStep
5	Country Beat 1
6	Country Beat 2
7	Country Rock
8	West Coast
9	Finger Picking
10	¾ Country
11	Modern Country

#	Name
12	Country Pop
13	Bar Country
14	Bluegrass
15	Country Boogie
16	Country Shuffle
17	Country 8 Beat
18	Country 16 Beat
19	Country Ballad 1
20	Country Ballad 2
Bank: Traditional	
1	German Waltz 1
2	German Waltz 2
3	German Waltz 3
4	Vienna Waltz
5	Italian Waltz
6	Musette Waltz
7	French Waltz
8	Irish Waltz
9	Laendler Waltz
10	German Polka
11	Italian Polka 1
12	Italian Polka 2
13	Italian Polka 3
14	Italian Mazurka 1
15	Italian Mazurka 2
16	Italian Mazurka 3
17	9/8
18	Vahde
19	2/4 Oyun
20	Ciftetelli
21	Halay
22	5/8
23	Oryantal
24	Turkish Pop
25	French March
26	March
Bank: Latin	
1	Samba Enredo
2	Samba Brazil
3	Bossa Nova
4	Classic Salsa
5	Classic Mambo
6	Classic Cha Cha
7	Guajira
8	Guaguancò
9	Timba
10	6/8 Afro
11	Bomba
12	Classic Bachata
13	Classic Merengue
14	Cumbia
15	Joropo

#	Name
16	Habanera
17	Rhumba 1
18	Rhumba 2
19	Salsa
20	Latin Big Band
21	Cool Latin Jazz
22	Pop Cha Cha
23	Latin Bolero
24	Latin Vocal
25	Meditation Bossa
26	Organ Bossa
27	OrchestralBossa1
28	OrchestralBossa2
29	Cool Bossa
30	Fast Bossa
31	Bachata
32	Mambo
Bank: Lat. Dance	
1	Reggaeton 1
2	Reggaeton 2
3	Modern Salsa
4	Latin Dance
5	Lambada
6	Meneaito
7	Macarena
8	Bomba Dance
9	Gipsy Dance
10	Hot Merengue
11	Disco Samba
12	Mambo Party
13	Modern Bachata
14	Disco Cha Cha
15	Bayon
16	Club Latino
17	Modern Bossa
18	Classic Beguine
19	Calypso
20	Andean
21	Reggae 1
22	Reggae 2
23	Limbo
24	Bamba
Bank: Jazz	
1	Bigger Band
2	Serenade Band
3	Jazz Club
4	BeBop
5	Medium Big Band
6	Fast Big Band
7	Classic Swing
8	Acoustic Jazz
9	Slow Swing Brush

#	Name
10	Swing Ballad 1
11	Swing Ballad 2
12	Swing Ballad 3
13	Orchestral Swing
14	Jazz Brush
15	Medium JazzWaltz
16	Slow Jazz Waltz
17	Jazzy Blues
18	Organ Swing
19	Organ Blues
20	Swing Quintet
21	Medium Swing
22	Vocal Swing
23	Moon Swing
24	Soft Jazz
25	Django
26	5/4 Swing
27	Jazz Quartet
28	Stride
29	Dixieland
30	Charleston
31	Vocal Jazz
Bank: Movie & Show	
1	Screen EpicMarch
2	Burt's Bounce
3	Orchestral Movie
4	Broadway
5	Show Time
6	Ritz Swing
7	Hollywood 1
8	Hollywood 2
9	Tap Dance
10	Movie Ballad
11	Movie Swing
12	Safari Swing
13	Western Movie
14	Mystery Man
15	Cartoon Time
16	Horror Movie
17	Love Movie
18	Artie's Theme
19	Christmas Waltz
20	Christmas Swing
21	Theatre Swing
22	Theatre March
23	Love Ballad
24	Army Band
Bank: Funk & Soul	
1	Funk R&B
2	Kool Funk
3	Easy Funk
4	Elektrik Funk

#	Name
5	Classic Funk
6	Soul Ballad
7	Talkin' Jazz
8	Funky Sisters
9	Rhythm & Blues
10	Blues
11	Soul
12	Gospel
13	Gospel Swing
14	Gospel Shuffle
15	Modern Gospel 1
16	Modern Gospel 2
17	Al Swing
18	Groove
19	Groove Funk
20	Jazz Funk
21	Motown Shuffle 1
22	Motown Shuffle 2
23	Cool Vocal
24	70's Beat Groove
25	Al Funk
26	Urban Funk
Bank: World	
1	Spanish Dance
2	4/4 Flamenco
3	¾ Flamenco
4	Casatchock
5	Greek Rumba
6	Xasapiko
7	Sirtaki
8	Zouk
9	Hawaiian
10	Mexican Waltz
11	Norteno
12	Kebradita
13	Bolero Ranchero
14	Mariachi Polka
15	Mariachi Valz
16	Mariachi Cumbia
17	Alpen Schlager
18	Classic Schlager
19	Modern Schlager
20	Vienna Waltz
21	Tarantella
22	Rumba Napoletana
23	Raspa
24	Mad Ska
25	Celtic Dream
26	Celtic Waltz
27	Celtic Ballad
28	Scottish Reel
29	Banda
30	OrchestralBolero

#	Name
31	Minuetto
32	Baroque
33	Orleans
34	Cajun
35	Zydeco
36	Hora
Bank: Contemporary	
1	Funky R&B
2	AM : PM
3	Contemporary Bld
4	Island View
5	Fast Smooth Jazz
6	Slow Smooth Jazz
7	Slow & Jazzy
8	Take Beat
9	Swing HipHop
10	Slow Mood
11	Hip Hindi Hop
12	Soft HipHop
13	New Age
14	Kyoto Lounge
15	Jazzy Funk
16	Slow Funk
17	Elektro Pop
18	Modern Latin
19	Folk Beat
20	Wave Jazz
21	Little Shuffle
22	Rap
23	Pop Rock Hit
24	Dance Hit

Style Elements

Note: You can remotely select the various Style Elements on the Pa900, by sending it Program Change messages on the Control channel (see “MIDI: MIDI In Channels” on page 260).

PC	Style Element	PC	Style Element	PC	Style Element	PC	Style Element	PC	Style Element
80	Intro 1	81	Intro 2	82	Intro 3/Count In	83	Variation 1	84	Variation 2
85	Variation 3	86	Variation 4	87	Fill 1	88	Fill 2	89	Fill 3
90	Fill 4	91	Break	92	Ending 1	93	Ending 2	94	Ending 3

Note: The above Program Change numbers are given according to the 0-127 numbering system.

Style and Player controls

Note: You can remotely send various commands to the Style and Player of the Pa900, by sending it Program Change messages on the Control channel (see “MIDI: MIDI In Channels” on page 260).

PC	Style Element	PC	Style Element	PC	Style Element	PC	Style Element	PC	Style Element
95	Fade In/Out	96	STS Mode	97	Auto Fill	98	Memory	99	Bass Inversion
100	Manual Bass	101	Tempo Lock	102	Style Change	103	Start/Stop (Style)	104	Play/Stop (Player)

Note: The above Program Change numbers are given according to the 0-127 numbering system.

Single Touch Settings (STS)

Note: You can remotely select Single Touch Settings (STS) on the Pa900, by sending it Bank Select MSB (CC#0), Bank Select LSB (CC#32) and Program Change messages on the Control channel (see “MIDI: MIDI In Channels” on page 260). If a Style is already selected, just send the Program Change message.

CC#0	CC#32	PC	STS	PC	STS	PC	STS	PC	STS
The same as the Style to which the STS belongs		64	STS 1	65	STS 2	66	STS 3	67	STS 4

Note: The above Control Change and Program Change numbers are given according to the 0-127 numbering system.

Sounds

The following table lists all Pa900 Factory Sounds as they appear in the Sound Select window.

Legend: The table also includes MIDI data used to remotely select the Sounds. **CC00:** Control Change 0, or Bank Select MSB. **CC32:** Control Change 32, or Bank Select LSB. **PC:** Program Change. **Bank:** Sound Select button.

Name	CC00	CC32	PC
Factory: Piano			
Grand Piano RX	121	10	0
Concert Grand RX	121	13	0
Live Piano RX	121	6	1
Bright Piano RX	121	5	1
Classic Piano	121	4	0
Jazz Piano	121	5	0
Rock Piano	121	8	0
Grand Piano Live	121	12	0
G.Piano Stack 1	121	8	2
G.Piano Stack 2	121	9	2
Honky-Tonk RX	121	2	3
Ragtime Piano	121	3	3
Grand&MovingPad	121	9	0
E. Grand Phaser	121	10	2
Piano & Strings	121	7	0
Piano & Pad	121	4	1
Harpsichord RX	121	6	6
Clav RX	121	5	7
Synth Clav RX	121	6	7
Clav Wah RX	121	2	7
Piano Layers	121	6	2
Grand & FM Stack	121	7	2
Piano & Vibes	121	6	0
Grand RX DEMO	121	11	0
Factory: E. Piano			
Tine EP Phaser	121	27	4
Tine EP Dyno	121	28	4
Tine EP Amp/Phas	121	29	4
Wet Tine EP	121	31	4
Dist. Tine EP	121	30	4
Bell Tine EP	121	32	4
Suit Case88 EP1	121	33	4
Suit Case88 EP2	121	34	4
Wurly Logic	121	36	4
Wurly Amp	121	38	4
Wurly Clean 1	121	39	4
Wurly Clean 2	121	41	4
Reed EP Clean	121	37	4
Wurly AmpChorus	121	40	4
Natural Wurly	121	44	4
Wurly RX Noise	121	42	4
VPM E. Piano	121	17	5

Name	CC00	CC32	PC
Digi E. Piano	121	14	5
Classic Tines	121	9	5
DW8000 EP	121	11	5
Natural EP	121	43	4
E.Piano RX Noise	121	35	4
EP+Damper 1 DNC	121	25	4
EP+Damper 2 DNC	121	26	4
Tine E.Piano RX	121	18	4
Club E. Piano	121	11	4
Suit E.Piano 1	121	20	4
Suit E.Piano 2	121	21	4
Classic Wurly 1	121	17	4
Classic Wurly 2	121	12	4
Tremolo Wurly	121	16	4
R&B E. Piano	121	8	4
FM Pad EP	121	15	5
White Pad EP	121	13	5
Thin E. Piano	121	9	4
Tine E. Piano	121	19	4
Dyno Tine EP 1	121	10	4
Dyno Tine EP 2	121	22	4
Studio EP	121	7	4
Pro Dyno EP	121	5	4
Pro Stage EP	121	6	4
Bell E. Piano 1	121	23	4
Bell E. Piano 2	121	24	4
Road Piano	121	11	2
Factory: Mallet & Bell			
Vibraphone 1	121	2	11
Marimba	121	7	12
Marimba Key Off	121	2	12
Xylophone	121	1	13
Glockenspiel	121	2	9
Celesta	121	1	8
Music Box	121	2	10
Balaphon	121	6	12
Kalimba 1	121	2	108
Kalimba 2	121	1	108
Sistro	121	1	9
Orgel	121	1	10
Warm Steel	121	1	114
Vs Bell Boy	121	2	98
Tubular Bell	121	4	14
Bells	121	3	14
Santur	121	1	15
Mallet Clock	121	5	12
Factory: Accordion			
Jazz Harm. DNC	121	6	22
Sweet Harm. DNC	121	7	22
Harmonica 1 DNC	121	5	22
Harmonica 2 DNC	121	9	22
Harmonica 3 DNC	121	10	22

Name	CC00	CC32	PC
Melodica DNC	121	8	22
Classic Musette	121	29	21
Cassotto 16'	121	12	21
Cassotto	121	9	21
Master Accordion	121	23	21
Sweet Musette	121	11	21
French Musette	121	18	21
2 Voices Musette	121	16	21
3 Voices Musette	121	17	21
Accordion 16,8,4'	121	3	23
Cassotto Or.Tune	121	13	21
Acc. Clarinet OT	121	19	21
Fisa Master	121	8	21
Harmonica AT 1	121	3	22
Harmonica AT 2	121	4	22
Harmonica	121	2	22
Acc. Piccolo OT	121	21	21
Accordion 16,8'	121	2	23
Acc. 16,8,4' Plus	121	8	23
Fisa 16,8'	121	6	21
Accordion 16,4'	121	7	23
Fisa 16,4'	121	7	21
Musette 1	121	3	21
Musette 2	121	4	21
Tango Accordion	121	10	23
Fisa Tango!	121	1	23
Accordion	121	24	21
Acc. 16,8' & Bass	121	4	23
Acc. & Acc. Bass	121	9	23
Accordion Bass	121	5	23
Steirisch.Akk.1	121	25	21
Steirisch.Akk.2	121	26	21
Steirisch.Akk.3	121	27	21
Steirisch.Akk.4	121	28	21
Acc.Voice Change	121	6	23
Factory: Organ			
DRAWBARS	121	127	16
Jimmy Organ	121	13	18
Classic Perc.Org	121	12	17
Organ Low+1'V.	121	33	16
Perc. Organ 1	121	10	17
Perc. Organ 2V.	121	9	17
Perc. Organ 3V.	121	11	17
Organ 16+51/3 V.	121	36	16
BX3 Rock 1 V.	121	10	16
BX3 Rock 2 V.	121	1	18
BX3 Rock 3 V.	121	5	18
BX3 Rock 4 V.	121	12	18
BX3 Full V.	121	6	16
BX3 Jazz V.	121	20	16
BX3 Jazz Pc. V.	121	9	18
BX3 Gospel V.	121	21	16
Jimmy Organ V.	121	10	18

Name	CC00	CC32	PC
Gospel Organ V.	121	13	16
Drawbars Slow V.	121	19	16
Drawbars Fast V.	121	18	16
Drawbars Organ	121	14	16
Jazz Organ	121	8	16
Organ Hi V.	121	17	16
Organ LowPc V.	121	4	17
Organ Low 1 V.	121	4	16
Organ Low 2 V.	121	15	16
Organ Mid V.	121	16	16
Organ HiMix1 V.	121	34	16
Organ HiMix2 V.	121	35	16
Big Theatre Org.	121	30	16
Theatre Organ 1	121	22	16
Theatre Organ 2	121	23	16
Pipe Tutti 1	121	6	19
Pipe Tutti 2	121	8	19
Pipe Tutti 3	121	9	19
Pipe Tutti 4	121	10	19
Church Pipes	121	4	19
Full Pipes	121	5	19
Pipe Mixture	121	3	19
Pipe Flute 1	121	4	20
Pipe Flute 2	121	5	20
Flauto Pipes	121	3	20
Small Pipe	121	2	20
Positive Organ	121	7	19
Factory: Guitar			
Concert Gtr DNC	121	20	24
Concert Gtr Pro	121	21	24
ClassicSteel DNC	121	36	25
Classic12Str Pro	121	37	25
Lead Guitar DNC	121	4	29
E.Gtr Ch/Dly DNC	121	35	27
Dist. Gtr 1 DNC	121	13	30
Dist. Gtr 2 DNC	121	14	30
RealNylon Gtr ST	121	16	24
Real Nylon Gtr	121	17	24
Classic12Str DNC	121	38	25
Classic 12Str RX	121	39	25
Stra. Gtr 1 DNC	121	32	27
Stra. Gtr 2 DNC	121	33	27
Crunch Gtr DNC	121	3	29
Chorus Gtr DNC	121	34	27
RealSteel Gtr ST	121	28	25
RealFolk Gtr ST1	121	29	25
RealFolk Gtr ST2	121	30	25
Steel Gtr RX	121	35	25
Jazz Gtr 1 DNC	121	7	26
Jazz Gtr 2 DNC	121	8	26
Soft Jazz Guitar	121	5	26
E.Gtr Amp DNC	121	37	27
Single Coil Pro	121	14	27

Name	CC00	CC32	PC
Nylon Guitar DNC	121	18	24
Natural Nylon	121	19	24
RealFolk Gtr DNC	121	34	25
Real 12 Strings	121	33	25
Nylon Gtr Pro1	121	8	24
Nylon Gtr Pro2	121	11	24
Nylon Slide Pro	121	14	24
Steel Guitar Pro	121	19	25
12 Strings Pro	121	17	25
Steel 12 Strings	121	5	25
Real Steel Gtr	121	31	25
Real Folk Gtr	121	32	25
Real El. Gtr ST1	121	28	27
Real El. Gtr ST2	121	29	27
Real El. Guitar1	121	30	27
Real El. Guitar2	121	31	27
JazzGtr SlidePro	121	6	26
Club Jazz Gtr 1	121	2	26
Clean Jazz 1	121	22	27
Clean Jazz 2	121	23	27
Pop Steel Gtr 1	121	21	25
Pop Steel Gtr 2	121	22	25
5th Mute Gtr	121	21	28
Stereo Dist.Gtr	121	8	30
Solid Guitar	121	21	27
Steel Slide Pro1	121	13	25
Steel Slide Pro2	121	14	25
Clean Guitar 1	121	20	27
Funk Stein RX1	121	12	28
Clean Funk RX1	121	10	28
Dist. Guitar RX1	121	9	30
Dist. Guitar RX2	121	10	30
Vintage S. 1	121	19	27
Clean Mute Gtr	121	6	28
Ac.Guitar KeyOff	121	5	24
Steel Guitar 1	121	4	25
Steel Guitar 2	121	20	25
Clean Gtr Pro 1	121	13	27
Clean Gtr Pro 2	121	15	27
Dist. Clean Gtr	121	11	30
Chorus Gtr Pro	121	18	27
Pedal Steel	121	4	26
'54 E. Guitar	121	24	27
Single Coil	121	6	27
Stra. Vel. Pro	121	16	27
New Stra.Guitar	121	7	27
Soft Overdrive	121	2	29
Chorus Guitar	121	3	27
Vintage S. 2	121	4	27
Processed E.Gtr	121	5	27
L&R E.Guitar 1	121	9	27
R&R Guitar	121	4	28
Power Chords	121	4	30

Name	CC00	CC32	PC
Mute Monster	121	5	30
Disto Mute	121	9	28
Steel Gtr DNC	121	44	25
Nylon Gtr RX1	121	12	24
Nylon Gtr RX2	121	13	24
Steel Guitar RX1	121	15	25
Steel Guitar RX2	121	16	25
12 Strings RX	121	18	25
Concert 12Str RX	121	22	24
Pop SteelGtr RX1	121	24	25
Pop SteelGtr RX2	121	25	25
Vox Wah Chick RX	121	3	120
Funky Wah RX	121	12	27
Power Chords RX	121	15	30
Clean Funk RX2	121	36	27
Clean Funk RX3	121	11	28
Funk Stein RX2	121	13	28
Clean Guitar RX1	121	14	28
Clean Guitar RX2	121	15	28
Clean Guitar RX3	121	16	28
Clean Guitar RX4	121	17	28
Clean Guitar RX5	121	18	28
Clean Guitar RX6	121	20	28
Factory: Strings & Vocal			
Violin DNC	121	9	40
Real Violin DNC	121	7	40
Violin Expr. DNC	121	5	40
Conc.Violin DNC	121	6	40
SopranoVox1 DNC	121	4	53
SopranoVox2 DNC	121	5	53
Real Strings 1	121	9	49
Real Strings 2	121	10	49
Movie Str.1 DNC	121	7	49
Movie Str.2 DNC	121	8	49
Archi & Orch. V.	121	24	48
Classic Harp	121	2	46
Violin Expr. 1	121	8	40
Violin Expr. 2	121	2	40
SopranoChoir DNC	121	6	53
Scat Voices DNC	121	20	52
Cycle Scat 1	121	21	52
Cycle Scat 2	121	22	52
Little Boy Voice	121	23	52
Movie Strings 1	121	5	49
Movie Strings 2	121	6	49
Concert Strings	121	11	49
Strings Ens. RX	121	22	48
Concert Str.RX	121	23	48
Full Strings	121	2	49
Ensemble & Solo	121	11	48
Tremolo Strings	121	1	44
Class.Contrabass	121	1	43
Cello	121	1	42

Name	CC00	CC32	PC
Viola Expr.	121	1	41
Violin & Viola	121	2	41
Violin Expr. 3	121	4	40
Slow Violin	121	3	40
Strings Quartet	121	9	48
Chamber Strings	121	12	48
Orchestra Tutti1	121	14	48
Orchestra Tutti2	121	19	48
Orch. & Oboe 1	121	16	48
Orch. & Oboe 2	121	17	48
Orchestra&Flute	121	20	48
Strings & Horns	121	15	48
Strings & Glock.	121	18	48
Pizz. Ensemble	121	1	45
Pizz. Section	121	2	45
Octave Strings	121	8	48
Spiccato Strings	121	4	49
StrappatoStrings	121	12	49
Symphonic Bows	121	10	48
Analog Strings 1	121	5	50
Synth Strings 1	121	6	50
Scat V.& Bass1	121	17	52
Scat V.& Bass2	121	18	52
Wuuh Choir	121	8	52
Oh-Ah Voices	121	9	52
Femal&Male Scat	121	14	52
Take Voices 1	121	4	52
Ooh Slow Voice	121	3	52
Scat Voices RX	121	19	52
Male Scat	121	16	52
Femal Scat	121	15	52
Grand Choir	121	11	52
Ooh Choir	121	6	52
Ooh Voices	121	2	52
Choir Light	121	12	52
Synth Voices	121	6	54
Full Vox Pad	121	9	91
Vocalesque	121	2	54
Fresh Breath	121	7	91
Vocalscape	121	3	54
Heaven	121	3	91
Airways	121	3	53
Factory: Trumpet & Trbn.			
JazzTrumpet1 DNC	121	24	56
JazzTrumpet2 DNC	121	27	56
JazzTrumpet3 DNC	121	28	56
Trumpet Expr.DNC	121	26	56
Jazz Trb. 1 DNC	121	15	57
Jazz Trb. 2 DNC	121	14	57
Jazz Trb. 3 DNC	121	18	57
Soft Trb. DNC	121	16	57
JazzCornet 1 DNC	121	25	56
JazzCornet 2 DNC	121	29	56

Name	CC00	CC32	PC
Trb. Expr. DNC	121	17	57
Trombone DNC	121	13	57
Trumpet Expr.1	121	15	56
Trumpet Expr.2	121	4	56
Cornet Expr.	121	21	56
Wah Trumpet	121	2	59
Mute Trumpet	121	5	59
Sweet FlugelHorn	121	12	56
Trombone Expr. 1	121	6	57
Trombone Expr. 2	121	7	57
Trumpet Pro 1	121	10	56
Trumpet Pro 2	121	11	56
Trumpet Pro 3	121	16	56
Trumpet Overb.	121	2	56
Cornet Pro 1	121	22	56
Cornet Pro 2	121	23	56
Trombone Vel. 1	121	8	57
Trombone Vel. 2	121	9	57
Trombone Vel. 3	121	10	57
Flugel Horn Pro	121	13	56
Concert Trumpet	121	19	56
Concert Trp. Pro	121	20	56
Dual Trumpets	121	6	56
Hard Trombone	121	3	57
Trombone Pro Vel	121	11	57
Alp Trumpet	121	17	56
Trumpet	121	14	56
Trumpet Shake Y+	121	18	56
Trumpet Pitch	121	5	56
Alp Tuba	121	6	58
Tuba Gold	121	2	58
Oberkr. Tuba	121	1	58
Factory: Brass			
Big Band Brass 1	121	32	61
Big Band Brass 2	121	4	61
Tight Brass 1	121	27	61
Tight Brass 2	121	29	61
Tight Brass 3	121	2	61
Tight Brass 4	121	12	61
Trpt. & Horns	121	5	60
Trpts & Trombs	121	34	61
Soft Horns 1	121	6	60
Soft Horns 2	121	7	60
Soft Horns 3	121	8	60
Tight Brass Pro	121	28	61
Trumpet Ens2 Y+	121	36	61
Trumpet Ens.	121	9	61
Trombone Ens.	121	10	61
Trombones	121	11	61
Dyna Brass 1	121	14	61
Trpts & Brass	121	7	61
Fat Brass	121	13	61
Brass of Power	121	30	61

Name	CC00	CC32	PC
Glenn & Friends	121	3	61
Glenn & Boys	121	6	61
Sax & Brass	121	5	61
Brass & Sax	121	16	61
Mute Ensemble 1	121	3	59
Mute Ensemble 2	121	4	59
Sforzato Brass	121	23	61
Movie Brass	121	20	61
Flute Muted	121	6	73
French Section	121	2	60
Horns & Ensemble	121	4	60
Classic Horns	121	3	60
Synth Brass 1	121	5	62
Electrik Brass	121	4	62
Brass Section	121	31	61
Brass Fall	121	26	61
Brass Impact	121	4	55
Brass Hit	121	25	61
MorphAttackBrass	121	37	61
Factory: Sax			
Jazz Sax 1 DNC	121	13	65
Jazz Sax 2 DNC	121	14	65
Jazz Sax 3 DNC	121	16	65
Tenor Sax 1 DNC	121	12	66
Tenor Sax 2 DNC	121	13	66
Tenor Sax 3 DNC	121	14	66
Tenor Sax 4 DNC	121	15	66
Jazz Tenor RX	121	9	66
Alto Sax 1 DNC	121	12	65
Alto Sax 2 DNC	121	17	65
SoftLatinSax DNC	121	18	65
Alto Sax Expr.	121	9	65
Alto Sax RX	121	10	65
Tenor Sax Noise1	121	1	66
Tenor Sax Noise2	121	6	66
Soprano Sax DNC	121	5	64
Sweet Soprano 1	121	3	64
Sweet Soprano 2	121	4	64
Sweet Soprano 3	121	1	64
Soprano Pro	121	2	64
JazzBaritone DNC	121	5	67
Baritone Sax Pro	121	3	67
Baritone Sax	121	4	67
Sweet Alto Sax 1	121	5	65
Sweet Alto Sax 2	121	6	65
Soft Alto Sax	121	7	65
Alto Sax Pro	121	8	65
Tenor Sax Expr.2	121	8	66
Tenor Sax Expr.1	121	7	66
Jazz Tenor	121	10	66
Baritone Growl	121	1	67
Real Sax Ens. RX	121	15	65
Cool Sax Ens.	121	11	65

Name	CC00	CC32	PC
Sax Ensemble	121	2	65
Reed of Power	121	11	66
Breath & Key RX	121	2	121
Factory: Woodwind			
RealClarinet DNC	121	14	71
JazzClarinet DNC	121	15	71
SoloClarinet DNC	121	16	71
Clarinet 1 DNC	121	13	71
Clarinet 2 DNC	121	19	71
Clarinet 3 DNC	121	20	71
Jazz Flute 1 DNC	121	13	73
Jazz Flute 2 DNC	121	14	73
Classic Oboe	121	2	68
Orch. Flute DNC	121	12	73
Flute DNC	121	11	73
Whistle DNC	121	5	78
Shakuhachi Vel.	121	3	77
Panflute 1 DNC	121	2	75
Panflute 2 DNC	121	3	75
Blown Bottle	121	1	76
Bassoon	121	1	70
Piccolo	121	3	72
Ocarina	121	1	79
Flute Switch	121	2	73
Jazz Flute RX	121	10	73
Jazz Flute Expr.	121	1	73
Flute Dyn. 5th	121	3	73
Flute Frullato	121	4	73
Jazz Clarinet	121	1	71
Clarinet Pro 1	121	8	71
Clarinet Pro 2	121	9	71
Whistle	121	1	78
Whistle RX1	121	3	78
Whistle RX2	121	4	78
Whistle Breathe	121	2	78
Clar & Sax Ens.1	121	17	71
Clar & Sax Ens.2	121	18	71
Double Reed	121	1	68
Orchestra Flute	121	5	73
Woodwinds	121	6	71
Small Orchestra	121	1	72
Clarinet Ens.	121	5	71
Section Winds 1	121	3	71
Section Winds 2	121	4	71
Reeds & Saxes	121	10	71
Factory: Synth Pad			
Far memories	121	14	91
Atmoschoir Pad	121	15	91
Step Sequencer	121	7	96
Space Trailer	121	1	103
Warm Pad	121	15	89
Choir-Sequence	121	13	91

Name	CC00	CC32	PC
Techno Stab DNC	121	3	93
Wave-Sequence	121	4	96
Aerosonic	121	5	96
My Sequencer	121	6	96
Jurassic Pad	121	3	88
Pisco Pad	121	2	99
Tension Scene	121	8	97
Dronas Pad	121	4	93
Bengione	121	1	99
Chiff Touch Pad	121	1	83
Dreaming Coil	121	3	99
Organ Stab DNC	121	4	101
Deep Noise	121	4	127
The Pad	121	4	89
Dark Pad	121	6	89
OB Pad	121	12	89
Analog Pad 1	121	8	89
Analog Pad 2	121	9	89
Dark Anna	121	13	89
Symphonic Ens.	121	14	89
Future Pad	121	5	91
Air Clouds	121	1	97
Tinklin Pad	121	3	97
Pods In Pad	121	4	97
Vintage Sweep	121	7	95
Money Pad	121	5	89
Tsunami Wave	121	6	91
Ravelian Pad	121	8	91
Meditate	121	2	95
Super Sweep	121	4	90
Wave Sweep	121	5	90
Cross Sweep	121	6	90
Digi Ice Pad	121	2	101
Cinema Pad	121	5	95
Virtual Traveler	121	1	88
Motion Ocean	121	1	96
Moon Cycles	121	5	102
Bell Pad	121	6	98
Big Panner	121	4	63
Rave	121	6	97
Moving Bell	121	5	98
Analog Pad 3	121	10	89
Big Sweep Stab	121	12	90
Fresh Air 1	121	2	91
Fresh Air 2	121	11	91
Pop Synth Pad 1	121	4	91
Pop Synth Pad 2	121	12	91
80's Pop Synth	121	2	93
Wave Cycle	121	3	96
Warm Buzz	121	17	89
Next Analog	121	16	89
Double Sweep	121	9	95

Name	CC00	CC32	PC
Factory: Synth Lead			
Bass Phat Saw	121	12	87
Old Portamento	121	3	80
Power Saw	121	5	81
Octo Lead	121	6	81
Electro Lead	121	2	87
Rich Lead	121	3	87
Thin Analog Lead	121	4	87
Dance Lead	121	4	80
Wave Lead	121	5	80
Sine Wave	121	6	80
Express. Lead	121	5	87
HipHop Lead	121	6	87
Analog Lead	121	7	80
Phat Saw Lead	121	8	81
Glide Lead	121	9	81
Gliding Square	121	9	80
Power Synth	121	3	89
Sine Switch	121	10	80
Cosmic	121	1	93
Fire Wave	121	10	81
Digital PolySix	121	7	90
A Leadload	121	11	87
Noisy Stabb	121	8	90
Mega Synth	121	9	90
Dark Element	121	3	95
Metallic Rez	121	4	84
Synth Pianoid	121	12	81
Arp Angeles	121	2	88
Big & Raw	121	8	87
Caribbean	121	2	96
OB Lead	121	10	87
Port Whine	121	12	80
2VCO Planet Lead	121	13	80
VCF Modulation	121	3	101
Cycle Seq. 1	121	8	96
Cycle Seq. 2	121	9	96
Next Dance DNC	121	13	87
Next Morph Y+	121	15	87
Bros Buzz Y+	121	14	87
Factory: Ethnic			
Mandolin DNC	121	40	25
Mandolin	121	43	25
Mandolin Orch.1	121	41	25
Mandolin Orch.2	121	42	25
Real Cavaquinho	121	27	24
Cavaquinho 1	121	23	24
Cavaquinho 2	121	24	24
Real Ukulele	121	25	24
Zither	121	9	104
Sitar	121	8	104
Fiddle	121	1	110

Name	CC00	CC32	PC
Mandolin Trem.	121	11	25
Mandolin Ens. 1	121	26	25
Mandolin Ens. 2	121	27	25
Banjo Key Off	121	1	105
Banjo RX	121	4	105
Sitar Tambou	121	2	104
Kanoun 1	121	5	107
Kanoun 2	121	2	107
Kanoun Trem. 1	121	6	107
Kanoun Trem. 2	121	3	107
Kanoun Mix	121	4	107
Oud 1	121	5	105
Oud 2	121	2	105
Bouzouki	121	5	104
Nay	121	2	72
Clarinet G	121	2	71
Klarnet 1	121	11	71
Klarnet 2	121	12	71
Old Shakuhachi	121	1	77
Kawala	121	1	75
Hichiriki	121	2	111
HighlandBagPipes	121	3	109
Uilleann BagPipes	121	2	109
Indian Frets	121	4	104
Zurna 1	121	3	111
Zurna 2	121	1	111
Gamelan	121	1	112
Garbage Mall	121	3	112
Jaw Harp	121	3	105
Ac. Baglama 1	121	7	107
Ac. Baglama 2	121	8	107
Ac. Baglama Grp.	121	9	107
Factory: Bass			
Real Ac.Bass RX	121	12	32
Real Ac.Bass	121	13	32
Vintage P.Round	121	17	33
Vintage P. Flat	121	18	33
5 Strings BassRX	121	19	33
Dark E.Bass 1	121	20	33
Dark E.Bass 2	121	24	33
Finger Jazz B.RX	121	21	33
Dark E.Bass DNC	121	22	33
Vintage P. Bass	121	23	33
Vintage P. Pick	121	12	34
Picked Jazz Bass	121	13	34
MM Fretless B.RX	121	8	35
Woofers Pusher 1	121	9	35
Finger Bass DNC	121	16	33
Dark Bs&Slp DNC	121	7	36
Acous. Bass Pro1	121	3	32
Acous. Bass Pro2	121	4	32
Jazz Bass	121	9	32
Acoustic Bass	121	8	32

Name	CC00	CC32	PC
Finger Bass 1	121	6	33
Finger Bass 2	121	7	33
Finger Bass 3	121	10	33
Finger Bass 4	121	15	33
Finger Slap	121	12	33
The Other Slap	121	5	37
Thumb Bass	121	1	37
Pick Bass 1	121	7	34
Pick Bass 2	121	8	34
Super Bass 1	121	1	36
Super Bass 2	121	2	36
Sweet Fretless	121	3	35
Finger E.Bass 1	121	2	33
Finger E.Bass 2	121	3	33
Finger E.Bass 3	121	4	33
Fretless Bass 1	121	1	35
Fretless Bass 2	121	2	35
Bass & Ride 1	121	6	32
Bass & Ride 2	121	2	32
Bright Finger B.	121	9	33
Picked E.Bass 1	121	1	34
Picked E.Bass 2	121	2	34
Picked E.Bass 3	121	11	34
Chorus Fing.Bass	121	8	33
Bass Mute	121	5	34
Synth Bass 1	121	18	38
Synth Bass 2	121	15	39
Bass&Gtr Double	121	6	34
FingerB.& Guitar	121	14	33
Bass & Guitar	121	4	34
30303 Bass	121	5	38
Stein Bass	121	3	34
Jungle Rez	121	5	39
Syn Bass Res	121	8	38
Digi Bass 1	121	9	38
Digi Bass 3	121	11	38
Jungle Bass	121	13	38
Hybrid Bass	121	15	38
Digi Bass 2	121	10	38
Organ Pedal 1	121	10	32
Organ Pedal 2	121	11	32
Acous. Bass RX	121	7	32
Finger Bass RX	121	13	33
SlapFing Bass RX	121	4	36
Picked Bass RX	121	10	34
SlapPick Bass RX	121	5	36
FunkSlap Bass RX	121	3	36
Factory: Drum & SFX			
Incipit Noises	121	3	119
Legacy: Piano			
Grand Piano	121	3	0
M1 Piano	121	2	2

Name	CC00	CC32	PC
Piano Pad 1	121	2	1
Piano Pad 2	121	3	1
90's Piano	121	3	2
2000's Piano	121	4	2
Chorus Piano	121	5	2
Harpsi 16' RX	121	5	6
Harpsi Korg	121	4	6
Clav Snap	121	3	7
Sticky Clav	121	4	7
Honky-Tonk	121	4	3
Legacy: E. Piano			
Vintage EP	121	4	4
Stereo Dig. EP	121	6	5
FM Stack EP	121	16	5
Hybrid EP	121	8	5
Phantom Tine	121	10	5
Soft Wurly	121	13	4
Hard Wurly	121	14	4
Velo Wurly	121	15	4
Sweeping EP	121	12	5
Classic Dig. EP	121	7	5
Syn Piano X	121	5	5
Legacy: Mallet & Bell			
Vibraphone 2	121	3	11
Monkey Skuls	121	3	12
Digi Bell	121	4	98
Krystal Bell	121	3	98
Legacy: Accordion			
Sweet Harmonica	121	1	22
Akordeon	121	2	21
Cassotto NorTune	121	14	21
Acc. Clarinet NT	121	20	21
Acc. Piccolo NT	121	22	21
Detune Accordion	121	15	21
Musette Clar.	121	5	21
Arabic Accordion	121	10	21
Legacy: Organ			
Classic Click	121	4	18
Perc.Short Deca	121	8	18
Rock Organ 2	121	11	18
Dirty B	121	3	18
Killer B	121	2	18
BX3 Short Decay	121	7	17
Super BX Perc.	121	6	18
Gospel Organ	121	9	16
Old Wheels	121	3	17
Dark Organ 1	121	7	16
Dark Organ 2	121	5	16
Rotary Organ	121	8	17
VOX Legend	121	11	16
M1 Organ	121	5	17
Dirty JazzOrgan	121	7	18

Name	CC00	CC32	PC
Arabian Organ	121	12	16
Theatre Organ 3	121	24	16
Theatre Organ 4	121	25	16
Tibia	121	26	16
Tibia 16+8+4'	121	27	16
Tibia & Vox	121	28	16
Post Horn Trem.	121	29	16
Tibia & Kinura	121	31	16
Tibia Vox Glock	121	32	16
Techno Org.Bass	121	6	17
Legacy: Guitar			
Nylon Bossa	121	4	24
Nylon Vel. Harm.	121	10	24
Spanish Guitar	121	6	24
Nylon Guitar	121	15	24
Brazilian Guitar	121	9	24
Steel Folk Gtr	121	9	25
Guitar Strings	121	7	24
Finger Key Off	121	7	25
Club Jazz Gtr 2	121	3	26
Pop Steel Slide	121	23	25
Finger Tips	121	8	25
Country Nu	121	11	27
Reso Guitar	121	12	25
Tel. Middle	121	26	27
Clean Funk	121	8	28
Wet Dist. Guitar	121	6	30
Hackbrett	121	6	25
Tel. Bridge	121	27	27
Guitarish	121	8	27
Stra. Gtr Slide	121	17	27
Stra. Chime	121	5	28
Clean Guitar 2	121	25	27
L&R E.Guitar 2	121	10	27
Rhythm E.Guitar	121	7	28
Muted Guitar	121	19	28
E.Gtr Harmonics	121	2	31
Solo Dist.Guitar	121	7	30
Dist. Steel Gtr	121	12	30
Joystick Gtr Y-	121	3	30
Legacy: Strings & Vocal			
Strings Ens. 1	121	21	48
Strings Ens. 2	121	3	49
i3 Strings	121	5	48
Stereo Strings	121	3	48
Master Pad	121	2	89
N Strings	121	6	48
Arco Strings	121	7	48
Legato Strings	121	4	48
Double Strings	121	3	45
Arabic Strings	121	13	48
Sweeper Strings	121	1	49

Name	CC00	CC32	PC
Analog Strings 2	121	2	50
Synth Strings 2	121	1	51
Take Voices 2	121	5	52
Aah Choir	121	7	52
Slow Choir	121	10	52
Cyber Choir	121	2	85
Odyssey	121	4	50
Strings Choir	121	13	52
Analog Velve	121	3	50
Ether Voices	121	1	85
Dream Voice	121	5	54
Classic Vox	121	4	54
Doolally	121	2	53
Legacy: Trumpet & Trbn.			
Mono Trumpet	121	3	56
Warm Flugel	121	8	56
Pitch Trombone	121	5	57
Soft Trombone	121	4	57
Trombone	121	12	57
BeBop Cornet	121	9	56
Flugel Horn	121	7	56
Dynabone	121	3	58
Ob.Tuba&E.Bass 1	121	4	58
Ob.Tuba&E.Bass 2	121	5	58
Legacy: Brass			
Attack Brass	121	8	61
Big BandShake Y+	121	33	61
Trumpet Ens1 Y+	121	35	61
Dyna Brass 2	121	22	61
Double Brass	121	24	61
Power Brass	121	21	61
Brass Expr.	121	15	61
Film Brass	121	17	61
Brass Slow	121	18	61
Fanfare	121	19	61
Synth Brass 2	121	5	63
Brass Pad	121	3	63
Netherland Hit	121	8	55
Legacy: Sax			
Folk Sax	121	5	66
Breathy Baritone	121	2	67
Alto Breath	121	1	65
Tenor Breath	121	3	66
Breathy Alto Sax	121	3	65
Alto Sax Growl	121	4	65
Soft Tenor	121	2	66
Tenor Growl	121	4	66
Legacy: Woodwind			
Folk Clarinet	121	7	71
Flute	121	9	73
Wooden Flute	121	7	73
Bambu Flute	121	8	73

Name	CC00	CC32	PC
English Horn	121	1	69
Recorder 1	121	1	74
Recorder 2	121	2	74
Legacy: Synth Pad			
Sky Watcher	121	2	90
Vintage Pad	121	11	89
You Decide	121	8	95
Korgmatose	121	13	90
Reoccurring Astra	121	6	95
Astral Dream	121	1	95
Reso Down	121	2	97
Crimson 5ths	121	1	86
Freedom Pad	121	7	89
Noble Pad	121	5	97
Mellow Pad	121	4	95
Lonely Spin	121	1	100
Synth Ghostly	121	2	100
Farluce	121	11	90
Bell Choir	121	7	98
Dance ReMix	121	10	91
Elastick Pad	121	7	97
Legacy: Synth Lead			
Motion Raver	121	1	101
Synchro City	121	2	84
Wild Arp	121	6	55
Seq Lead	121	7	81
Old & Analog	121	8	80
Flip Blip	121	7	55
Reso Sweep	121	1	90
Synth Sweeper	121	3	90
Sync Kron	121	3	84
Tecno Phonic	121	10	90
Band Passed	121	3	102
Cat Lead	121	9	87
Pan Reso	121	4	102
Square Rez	121	11	80
Rezbo	121	11	81
Auto Pilot 1	121	14	38
Square Bass	121	7	87
Brian Sync	121	5	84
Arp Twins	121	6	84
LoFi Ethnic	121	7	84
Legacy: Ethnic			
Shakuhachi	121	2	77
Mandolin Key Off	121	10	25
War Pipes	121	1	109
Sitar Sitar	121	7	104
Hit in India	121	5	55
Tambra	121	6	104
Indian Stars	121	3	104
Bali Gamelan	121	2	112
Ukulele Gtr	121	26	24

Name	CC00	CC32	PC
Legacy: Bass			
Ac. Bass Buzz	121	1	32
Slap Bass 1	121	6	36
Slap Bass 2	121	6	37
Slap Bass 3	121	7	37
Dyna Slap Bass	121	3	37
Chorus Slap Bass	121	4	37
DarkWoody A.Bass	121	5	32
More Mid! Bass	121	11	33
Woofer Pusher 2	121	6	35
Dark R&B Bass1	121	4	35
Dyna Bass	121	2	37
Ticktacing Bass	121	9	34
Fretless Bass 3	121	7	35
Stick Bass	121	5	33
Dark R&B Bass2	121	5	35
Auto Pilot 2	121	13	39
Bass4 Da Phunk	121	14	39
Dr. Octave	121	16	38
Monofilter Bass	121	11	39
Synth Bass 80ish	121	9	39
Reso Bass	121	12	39
Autofilter Bass	121	10	39
Drive Bass	121	17	38
Nasty Bass	121	6	39
Euro Bass	121	4	39
30303 Square	121	6	38
Bass Square	121	7	38
Phat Bass	121	7	39
Blind As A Bat	121	12	38
Poinker Bass	121	8	39
Legacy: Drum & SFX			
Log Drum	121	4	12
Reverse Tom	121	2	117
Reverse Snare	121	3	118
Reverse Cymbal	121	2	119
Dragon Gong	121	1	119
Stadium	121	6	126
Castanets Plus	121	2	115
Timpani	121	1	47
Woodblock	121	3	115
Footstep Walk	121	7	126
GM: Piano			
AcousticPiano GM	121	0	0
Ac. Piano Wide	121	1	0
Ac. Piano Dark	121	2	0
Bright Piano GM	121	0	1
Bright PianoWide	121	1	1
E.Grand Piano GM	121	0	2
E. Grand Wide	121	1	2
Honky-Tonk GM	121	0	3
Honky Wide	121	1	3

Name	CC00	CC32	PC
E. Piano 1 GM	121	0	4
Detuned EP 1	121	1	4
EP 1 Veloc. Mix	121	2	4
60's E. Piano	121	3	4
E. Piano 2 GM	121	0	5
Detuned EP 2	121	1	5
EP 2 Veloc. Mix	121	2	5
EP Legend	121	3	5
EP Phase	121	4	5
Harpsichord GM	121	0	6
Harpsi OctaveMix	121	1	6
Harpsi Wide	121	2	6
Harpsi Key Off	121	3	6
Clav GM	121	0	7
Pulse Clav	121	1	7
GM: Chrom. Perc.			
Celesta GM	121	0	8
Glockenspiel GM	121	0	9
Music Box GM	121	0	10
Vibraphone GM	121	0	11
Vibraphone Wide	121	1	11
Marimba GM	121	0	12
Marimba Wide	121	1	12
Xylophone GM	121	0	13
Tubular Bell GM	121	0	14
Church Bell	121	1	14
Carillon	121	2	14
Dulcimer GM	121	0	15
GM: Organ			
Drawbar Org GM	121	0	16
Det. Drawbar Org	121	1	16
It. 60's Organ	121	2	16
Drawbar Org. 2	121	3	16
Perc.Organ GM	121	0	17
Det. Perc. Organ	121	1	17
Perc. Organ 2	121	2	17
Rock Organ GM	121	0	18
Church Organ GM	121	0	19
Church Oct. Mix	121	1	19
Detuned Church	121	2	19
Reed Organ GM	121	0	20
Puff Organ	121	1	20
Accordion GM	121	0	21
Accordion 2	121	1	21
Harmonica GM	121	0	22
Tango Accord.GM	121	0	23
GM: Guitar			
Nylon Guitar GM	121	0	24
Ukulele	121	1	24
Nylon Key Off	121	2	24
Nylon Guitar 2	121	3	24
Steel Guitar GM	121	0	25

Name	CC00	CC32	PC
12 Strings Gtr	121	1	25
Mandolin	121	2	25
Steel Gtr & Body	121	3	25
Jazz Guitar GM	121	0	26
Pedal Steel Gtr	121	1	26
Clean Guitar GM	121	0	27
Det.Clean El.Gtr	121	1	27
Mid Tone Gtr	121	2	27
Muted Guitar GM	121	0	28
Funky Cut El.Gtr	121	1	28
Mute Vel. El.Gtr	121	2	28
Jazz Man	121	3	28
Overdrive Gtr GM	121	0	29
Guitar Pinch	121	1	29
Distortion GtrGM	121	0	30
Feedback DistGtr	121	1	30
Dist. Rhythm Gtr	121	2	30
Gtr Harmonic GM	121	0	31
Guitar Feedback	121	1	31
GM: Bass			
Acoustic Bass GM	121	0	32
Finger Bass GM	121	0	33
Finger Slap Bass	121	1	33
Picked E.Bass GM	121	0	34
Fretless Bass GM	121	0	35
Slap Bass 1 GM	121	0	36
Slap Bass 2 GM	121	0	37
Synth Bass 1 GM	121	0	38
Synth Bass Warm	121	1	38
Synth Bass Reso	121	2	38
Clavi Bass	121	3	38
Hammer	121	4	38
Synth Bass 2 GM	121	0	39
SynthBass Attack	121	1	39
SynthBass Rubber	121	2	39
Attack Pulse	121	3	39
GM: Strings			
Violin GM	121	0	40
Slow Att. Violin	121	1	40
Viola GM	121	0	41
Cello GM	121	0	42
Contrabass GM	121	0	43
Tremolo Str. GM	121	0	44
Pizzicato Str.GM	121	0	45
Harp GM	121	0	46
Yang Chin	121	1	46
Timpani GM	121	0	47
GM: Ensemble			
Strings Ens.1 GM	121	0	48
Strings & Brass	121	1	48
60's Strings	121	2	48
Strings Ens.2 GM	121	0	49

Name	CC00	CC32	PC
Synth Strings1GM	121	0	50
Synth Strings 3	121	1	50
Synth Strings2GM	121	0	51
Choir Aahs GM	121	0	52
Choir Aahs 2	121	1	52
Voice Oohs GM	121	0	53
Humming	121	1	53
Synth Voice GM	121	0	54
Analog Voice	121	1	54
Orchestra Hit GM	121	0	55
Bass Hit Plus	121	1	55
6th Hit	121	2	55
Euro Hit	121	3	55
GM: Brass			
Trumpet GM	121	0	56
Dark Trumpet	121	1	56
Trombone GM	121	0	57
Trombone 2	121	1	57
Bright Trombone	121	2	57
Tuba GM	121	0	58
Muted Trumpet GM	121	0	59
Muted Trumpet 2	121	1	59
French Horn GM	121	0	60
FrenchHorn Warm	121	1	60
Brass Section GM	121	0	61
Brass Section 2	121	1	61
Synth Brass 1 GM	121	0	62
Synth Brass 3	121	1	62
Analog Brass 1	121	2	62
Jump Brass	121	3	62
Synth Brass 2 GM	121	0	63
Synth Brass 4	121	1	63
Analog Brass 2	121	2	63
GM: Reed			
Soprano Sax GM	121	0	64
Alto Sax GM	121	0	65
Tenor Sax GM	121	0	66
Baritone Sax GM	121	0	67
Oboe GM	121	0	68
English Horn GM	121	0	69
Bassoon GM	121	0	70
Clarinet GM	121	0	71
GM: Pipe			
Piccolo GM	121	0	72
Flute GM	121	0	73
Recorder GM	121	0	74
Pan Flute GM	121	0	75
Blown Bottle GM	121	0	76
Shakuhachi GM	121	0	77
Whistle GM	121	0	78
Ocarina GM	121	0	79

Name	CC00	CC32	PC
GM: Syn Lead / Syn Pad			
Lead Square GM	121	0	80
Lead Square 2	121	1	80
Lead Sine	121	2	80
Lead Saw GM	121	0	81
Lead Saw 2	121	1	81
Lead Saw & Pulse	121	2	81
Lead Double Saw	121	3	81
Lead Seq. Analog	121	4	81
Calliope GM	121	0	82
Chiff GM	121	0	83
Charang GM	121	0	84
Wire Lead	121	1	84
Voice Lead GM	121	0	85
Fifths Lead GM	121	0	86
Bass & Lead GM	121	0	87
Lead Soft Wrl	121	1	87
New Age Pad GM	121	0	88
Warm Pad GM	121	0	89
Sine Pad	121	1	89
Polysynth GM	121	0	90
Choir Pad GM	121	0	91
Itopia Pad	121	1	91
Bowed Glass GM	121	0	92
Metallic Pad GM	121	0	93
Halo Pad GM	121	0	94
Sweep Pad GM	121	0	95
GM: Synth SFX			
Ice Rain GM	121	0	96
Soundtrack GM	121	0	97
Crystal GM	121	0	98
Synth Mallet	121	1	98
Atmosphere GM	121	0	99
Brightness GM	121	0	100
Goblins GM	121	0	101
Echo Drops GM	121	0	102
Echo Bell	121	1	102
Echo Pan	121	2	102
Star Theme GM	121	0	103
GM: Ethnic			
Sitar GM	121	0	104
Sitar 2	121	1	104
Banjo GM	121	0	105
Shamisen GM	121	0	106
Koto GM	121	0	107
Taisho Koto	121	1	107
Kalimba GM	121	0	108
Bag Pipes GM	121	0	109
Fiddle GM	121	0	110
Shanai GM	121	0	111

Name	CC00	CC32	PC
GM: Percussive			
Tinkle Bell GM	121	0	112
Agogo GM	121	0	113
Steel Drums GM	121	0	114
Woodblock GM	121	0	115
Castanets	121	1	115
Taiko Drum GM	121	0	116
Concert BassDrum	121	1	116
Melodic Tom GM	121	0	117
Melodic Tom 2	121	1	117
Synth Drum GM	121	0	118
Rhythm Box Tom	121	1	118
Electric Drum	121	2	118
ReverseCymbalGM	121	0	119
GM: SFX			
Gtr FretNoise GM	121	0	120
Guitar Cut Noise	121	1	120
Ac. Bass String	121	2	120
Breath Noise GM	121	0	121
Flute Key Click	121	1	121
Seashore GM	121	0	122
Rain	121	1	122
Thunder	121	2	122
Wind	121	3	122
Stream	121	4	122
Bubble	121	5	122
Bird Tweet GM	121	0	123
Dog	121	1	123
Horse Gallop	121	2	123
Bird Tweet 2	121	3	123
Telephone GM	121	0	124
Telephone 2	121	1	124
Door Creaking	121	2	124
Door	121	3	124
Scratch	121	4	124
Wind Chime	121	5	124
Helicopter GM	121	0	125
Car Engine	121	1	125
Car Stop	121	2	125
Car Pass	121	3	125
Car Crash	121	4	125
Siren	121	5	125
Train	121	6	125
Jetplane	121	7	125
Starship	121	8	125
Burst Noise	121	9	125
Applause GM	121	0	126
Laughing	121	1	126
Screaming	121	2	126
Punch	121	3	126

Name	CC00	CC32	PC
Heart Beat	121	4	126
Footsteps	121	5	126
Gun Shot GM	121	0	127
Machine Gun	121	1	127
Laser Gun	121	2	127
Explosion	121	3	127

DNC Sounds

The following table lists all Pa900 Factory DNC Sounds as they appear in the Sound Select window.

Note: When a Performance contains Sounds making use of Sound Controllers 1 & 2 (SC1, SC2), these controllers must be assigned to the Assignable Switches, the Assignable Footswitch or an EC5 pedal.

Sound Name (Bank – Page)	Page	CC00	CC32	PC	Legato (IR)	Legato (OoR)	SC1	SC2	SCY+	SCY-	Damper
Bank: Electric Piano											
EP+Damper1 DNC	3	121	25	4							Halo
EP+Damper2 DNC	3	121	26	4							Halo
Bank: Accordion											
Jazz Harm. DNC	1	121	6	22			GU	RD	RU	FD on KR	
Sweet Harm. DNC	1	121	7	22			Bend	Wah	Smth	Bright	Breath
Harmonica 1 DNC	1	121	5	22			Bend	Wah	Smth	Bright	Breath
Harmonica 2 DNC	1	121	9	22		>±8st: RU/RD	GU	RD	RU	FD on KR	
Harmonica 3 DNC	1	121	10	22		>±8st: RU/RD	GU	RD	RU	FD on KR	
Melodica DNC	1	121	8	22			GU	RD	RU	FD on KR	
Bank: Guitar											
Concert Gtr DNC	1	121	20	24	< ±5st: Smth		Slide U	Harm		Body NZ	
ClassicSteel DNC	1	121	36	25	< ±5st: Smth		Slide U	Harm		Body NZ	
Lead Guitar DNC	1	121	4	29	< ±3st: Smth		AltAtk	>C7: alt FX			
E.Gtr Ch/Dly DNC	1	121	35	27	< ±5st: Smth		Slide U	Harm		Mute	
Dist. Gtr 1 DNC	1	121	13	30	< ±5st: Smth		Slide U	Harm		Mute	
Dist. Gtr 2 DNC	1	121	14	30	< ±5st: Smth		Slide U	Mute	Harm	Feedback	Cut NZ
Classic 12Str DNC	2	121	38	25			Slide U	Harm			
Stra. Gtr 1 DNC	2	121	32	27			Mute	Harm	AltAtk		
Stra. Gtr 2 DNC	2	121	33	27			Mute	Harm	AltAtk		
Crunch Gtr DNC	2	121	3	29	< ±5st: Smth		Slide U	Mute	Harm	Feedback	
Chorus Gtr DNC	2	121	34	27	< ±5st: Smth		Slide U	Mute	Harm	Feedback	
Jazz Gtr 1 DNC	3	121	7	26	< ±4st: Smth		Slide U	Harm	Bend		
Jazz Gtr 2 DNC	3	121	8	26	< ±4st: Smth		Slide U	Harm	Bend		
E.Gtr Amp DNC	3	121	37	27	< ±5st: Smth		Slide U	Harm		Mute	
Nylon Guitar DNC	4	121	18	24	< ±5st: Smth		Slide U	Harm		Body NZ	
RealFolk Gtr DNC	4	121	34	25	< ±4st: Smth		Slide U	Harm		Body NZ	
Steel Gtr DNC	11	121	44	25	< ±5st: Smth		Slide U	Harm	Mute	Body NZ	
Bank: Strings & Vocal											
Violin DNC	1	121	9	40	< ±9st: Smth	>±9st: Gliss U/D	>G4: 8GI U	8GI D	Stacc	Mord	
Real Violin DNC	1	121	7	40	< ±9st: Smth	>±9st: Gliss U/D	>G4: 8GI U	8GI D	Stacc	Mord	
Violin Expr. DNC	1	121	5	40	< ±9st: Smth	>±9st: Gliss U/D	>G4: 8GI U	8GI D	Spiccato	Mord	
Conc.Violin DNC	1	121	6	40	< ±5st: Smth		Pizzicato	Ens		Vol	
SopranoVox1 DNC	1	121	4	53	< ±6st: Smth	>±6st: Gliss U/D	>G4: 4th U	<F5: 5th D			
SopranoVox2 DNC	1	121	5	53	< ±11st: Smth	>±11st: Gliss U/D			Gliss U		
Movie Str.1 DNC	2	121	7	49			Solo	Pizzicato	Tremolo	Solo	
Movie Str.2 DNC	2	121	8	49			Smth	Pizzicato	Tremolo	Solo	
SopranoChoir DNC	2	121	6	53	< ±6st: Smth		>G4: 8GI U	<F5: 5th D			
Scat Voices DNC	2	121	20	52	< ±5st: Smth		FD	Smth		Bright	
Bank: Trumpet & Trbn											
JazzTrumpet1 DNC	1	121	24	56	< ±6st: Smth		Doit	FD	Shake	FD on KR	Breath
JazzTrumpet2 DNC	1	121	27	56	< ±4st: Smth	>±4st: Shk/FD	Doit	FD	Shake	RD on KR	Breath

Sound Name (Bank - Page)	Page	CC00	CC32	PC	Legato (IR)	Legato (OoR)	SC1	SC2	SCY+	SCY-	Damper
JazzTrumpet3 DNC	1	121	28	56	< ±6st: Smth	>±6st: RU/RD	Doit	FD	Shake	FD on KR	Breath
Trumpet Expr.DNC	1	121	26	56	< ±6st: Smth		Doit	FD	Shake	FD on KR	Breath
Jazz Trb.1 DNC	1	121	15	57	< ±12st: Smth		Gliss U	Gliss D	Gliss U	FD on KR	Breath
Jazz Trb.2 DNC	1	121	14	57	< ±12st: Smth		Gliss U	FD	Gliss U	FD on KR	Breath
Jazz Trb.3 DNC	1	121	18	57	< ±4st: Smth	>±4st: Gliss U/D	Gliss U	Gliss D	Gliss U	FD on KR	Breath
Soft Trb. DNC	1	121	16	57	< ±5st: Smth		Gliss U	Gliss D	Gliss U	FD on KR	
JazzCornet 1 DNC	2	121	25	56	< ±12st: Smth		Doit	FD	Gliss D	RD on KR	Breath
JazzCornet 2 DNC	2	121	29	56	< ±8st: Smth	>±8st: RU/RD	Doit	FD	Gliss D	RD on KR	Breath
Trb. Expr. DNC	2	121	17	57	< ±5st: Smth		Gliss U	FD	Gliss U	FD on KR	
Trombone DNC	2	121	13	57	< ±12st: Smth		Doit	FD	Bend	Bright	Breath
Bank: Sax											
Jazz Sax 1 DNC	1	121	13	65	< ±12st: Smth		GU	FD	RU	FD on KR	Breath
Jazz Sax 2 DNC	1	121	14	65	< ±12st: Smth		GU	RD	RU	FD on KR	Breath
Jazz Sax 3 DNC	1	121	16	65	< ±9st: Smth	>±9st: RU/RD	GU	RD	RU	FD on KR	Breath
Tenor Sax 1 DNC	1	121	12	66	< ±12st: Smth		Soft	Straight	Gliss D	Bright	Breath
Tenor Sax 2 DNC	1	121	13	66	< ±9st: Smth	>±9st: RU/RD	GU	RD	RU	FD on KR	Breath
Tenor Sax 3 DNC	1	121	14	66	< ±9st: Smth	>±9st: RU/RD	GU	RD	RU	FD on KR	Breath
Tenor Sax 4 DNC	1	121	15	66	< ±9st: Smth	>±9st: RU/RD	GU	RD	RU	FD on KR	Breath
Alto Sax 1 DNC	2	121	12	65	< ±12st: Smth		Soft	Growl	Gliss D		Breath
Alto Sax 2 DNC	2	121	17	65	< ±9st: Smth	>±9st: RU/RD	GU	RD	RU	FD on KR	Breath
SoftLatinSax DNC	2	121	18	65	< ±9st: Smth	>±9st: RU/RD	GU	RD	RU	FD on KR	Breath
Soprano Sax DNC	2	121	5	64	< ±9st: Smth	>±9st: RU/RD	GU	RD			Breath
JazzBaritone DNC	3	121	5	67	< ±9st: Smth	>±9st: RU/RD	GU	GD		FD on KR	Breath
Bank: Woodwind											
RealClarinet DNC	1	121	14	71	< ±12st: Smth		Long RU	Long FD	Short RU	FD on KR	Breath
JazzClarinet DNC	1	121	15	71	< ±12st: Smth		Long RU	Long FD	Short RU	FD on KR	Breath
SoloClarinet DNC	1	121	16	71	< ±5st: Smth		Long RU	Long FD		FD on KR	
Clarinet 1 DNC	1	121	13	71	< ±5st: Smth		Bend	Bend	Soft	Ensemble	Breath
Clarinet 2 DNC	1	121	19	71	< ±8st: Smth	>±8st: RU/RD	Long RU	Long FD	Short RU	FD on KR	Breath
Clarinet 3 DNC	1	121	20	71	< ±8st: Smth	>±8st: RU/RD	Long RU	Long FD	Short RU	FD on KR	Breath
Jazz Flute 1 DNC	1	121	13	73	< ±5st: Smth		RU	RD	Voice	FD on KR	Breath
Jazz Flute 2 DNC	1	121	14	73	< ±8st: Smth	>±8st: Gliss U/D	RU	RD	Frull	FD on KR	Breath
Orch. Flute DNC	2	121	12	73	< ±5st: Smth		RU	RD	Voice	FD on KR	Breath
Flute DNC	2	121	11	73	< ±5st: Smth		Voice	Frull	Harm	Voice	Breath
Whistle DNC	2	121	5	78			Soft	GD	FD	Breath	Breath
Panflute 1 DNC	2	121	2	75	< ±12st: Smth		GU	Mord		Attack	
Panflute 2 DNC	2	121	3	75	< ±12st: Smth		GU	Mord		Attack	
Bank: Synth Pad											
Techno Stab DNC	1	121	3	93			Filter	Straight		Straight	
Organ Stab DNC	3	121	4	101			Filter	Straight		Straight	
Bank: Synth Lead											
Next Dance DNC	5	121	14	87			Noise		Filter	Filter	

Legend:
IR = In Range; **OoR** = Out of Range; **RU** = Riff Up; **KR** = Key Release; **AltAtk** = Alternate Attack; **Smth** = Smoother Attack; **RD** = Riff Down; **FD** = Fall Down; **GU** = Glide Up; **Slide U** = Slide Up; **Gliss U** = Glissato Up; **Gliss D** = Glissato Down; **8GI U** = Octave Glissato Up; **8GI D** = Octave Glissato Down; **Ens** = Ensemble; **Bend** = Bending; **Shk** = Shake; **Stacc** = Staccato; **Mord** = Mordente; **Frull** = Frullato (flutter tongue); **Body NZ** = Body Noise; **Cut NZ** = Cut Noise; **Harm** = Harmonics; **Bright** = Brightness; **Det** = Detune; **Vol** = Volume.

Drum Kits

The following table lists all Pa900 Factory Drum Kits in order of Bank Select-Program Change number.

Legend: The table also includes MIDI data used to remotely select the Drum Kits. **CC00:** Control Change 0, or Bank Select MSB. **CC32:** Control Change 32, or Bank Select LSB. **PC:** Program Change.

CC00	CC32	PC	Name	Sound Bank
120	0	0	Standard Kit GM	GM: Drum
120	0	1	Standard Kit RX2	Factory: Drum & SFX
120	0	2	Standard Kit RX3	Factory: Drum & SFX
120	0	3	Ambient Kit RX	Factory: Drum & SFX
120	0	4	Pop Std. Kit RX	Factory: Drum & SFX
120	0	5	Standard Kit RX1	Factory: Drum & SFX
120	0	6	Standard Kit RX4	Factory: Drum & SFX
120	0	7	Standard Kit	Legacy: Drum & SFX
120	0	8	Room Kit GM	GM: Drum
120	0	9	HipHop Kit 1	Factory: Drum & SFX
120	0	10	Jungle Kit	Factory: Drum & SFX
120	0	11	Techno Kit 1	Factory: Drum & SFX
120	0	12	Room Kit 2	Legacy: Drum & SFX
120	0	13	HipHop Kit 2	Legacy: Drum & SFX
120	0	14	Techno Kit 2	Legacy: Drum & SFX
120	0	15	Techno Kit 3	Legacy: Drum & SFX
120	0	16	Power Kit GM	GM: Drum
120	0	17	Power Kit 2	Legacy: Drum & SFX
120	0	18	Power Kit RX1	Factory: Drum & SFX
120	0	19	Power Kit RX2	Factory: Drum & SFX
120	0	24	Electro Kit GM	GM: Drum
120	0	25	Analog Kit GM	GM: Drum
120	0	26	House Kit 1	Legacy: Drum & SFX
120	0	27	House Kit 2	Legacy: Drum & SFX
120	0	28	House Kit 3	Legacy: Drum & SFX
120	0	30	House Kit RX1	Factory: Drum & SFX
120	0	31	House Kit RX2	Factory: Drum & SFX
120	0	32	Jazz Kit GM	GM: Drum
120	0	33	Jazz Kit RX1	Factory: Drum & SFX
120	0	34	Jazz Kit RX2	Factory: Drum & SFX
120	0	35	Jazz Kit RX3	Factory: Drum & SFX
120	0	40	Brush Kit GM	GM: Drum
120	0	41	Brush Kit 2	Legacy: Drum & SFX
120	0	42	Brush Kit RX1	Factory: Drum & SFX
120	0	43	Brush Kit RX2	Factory: Drum & SFX
120	0	44	Brush Kit RX3	Factory: Drum & SFX
120	0	48	Orchestra Kit GM	GM: Drum
120	0	49	Orchestra Kit	Legacy: Drum & SFX
120	0	50	Bdrum&Sdrum Kit	Legacy: Drum & SFX
120	0	51	Arabian Kit 1	Factory: Drum & SFX
120	0	56	SFX Kit GM	GM: Drum
120	0	57	SFX Kit 2	Factory: Drum & SFX
120	0	58	Synth Kit 2	Factory: Drum & SFX

CC00	CC32	PC	Name	Sound Bank
120	0	59	Synth Kit 1	Factory: Drum & SFX
120	0	60	SFX Kit 1	Factory: Drum & SFX
120	0	64	Percussion Kit	Factory: Drum & SFX
120	0	65	Latin Perc.Kit 1	Factory: Drum & SFX
120	0	66	Trinity Perc.Kit	Factory: Drum & SFX
120	0	67	i30 Perc. Kit	Factory: Drum & SFX
120	0	68	Latin Perc.Kit 2	Factory: Drum & SFX
120	0	69	Standard PercKit	Factory: Drum & SFX
120	0	72	HipHop Kit RX	Factory: Drum & SFX
120	0	73	Techno Kit RX	Factory: Drum & SFX
120	0	74	Dance Kit RX	Factory: Drum & SFX
120	0	75	Electro Kit RX1	Factory: Drum & SFX
120	0	76	Electro Kit RX2	Factory: Drum & SFX
120	0	89	Pop Std. Kit 1	Factory: Drum & SFX
120	0	90	Pop Std. Kit 2	Factory: Drum & SFX
120	0	96	Elektro Kit 1	Factory: Drum & SFX
120	0	97	Elektro Kit 2	Factory: Drum & SFX
120	0	117	Arabian Kit 2	Factory: Drum & SFX
120	0	118	Turkish Kit	Factory: Drum & SFX
120	0	119	Oriental PercKit	Factory: Drum & SFX
120	0	120	Room Kit 1	Factory: Drum & SFX
120	0	121	Power Kit 1	Legacy: Drum & SFX
120	0	122	Electro Kit	Factory: Drum & SFX
120	0	123	Analog Kit	Factory: Drum & SFX
120	0	125	Brush Kit 1	Legacy: Drum & SFX
127	0	0	Standard Kit1 XG	GM: Drum
127	0	9	Standard Kit2 XG	GM: Drum
127	0	8	Room Kit XG	GM: Drum
127	0	16	Rock Kit XG	GM: Drum
127	0	24	Electro Kit XG	GM: Drum
127	0	25	Analog Kit XG	GM: Drum
127	0	32	Jazz Kit 1 XG	GM: Drum
127	0	48	Jazz Kit 2 XG	GM: Drum
127	0	40	Brush Kit XG	GM: Drum
127	0	17	Classic Kit XG	GM: Drum
120	64	0-127	...	User DK

Multisamples

The following is a list of all Pa900 Factory Multisamples.

* **OrigTune:** *Original Tune, i.e., samples use the natural tuning of the original instrument, instead of the equal tuning. Beating may occur at the extreme pitch, when the sound is used in conjunction with other sounds.*

0	GrandPiano_L	38	E.Piano Dyno f	76	4' 22/3' 2' LF R
1	GrandPiano_R	39	E.Piano Dyno ff	77	4' 22/3' 2' LS L
2	GrandPiano_L OrigTune	40	E.Piano Dyno Soft	78	4' 22/3' 2' LS R
3	GrandPiano_R OrigTune	41	E.Piano Dyno SoftLP	79	11/3' 13/5' 1'LF L
4	Resonance_L	42	E.Piano Stage Hard	80	11/3' 13/5' 1'LF R
5	Resonance_R	43	E.Piano Stage HardLP	81	11/3' 13/5' 1'LS L
6	Resonance_L OrigTune	44	E.Piano Vintage pp	82	11/3' 13/5' 1'LS R
7	Resonance_R OrigTune	45	E.Piano Vintage p	83	16' 8' 51/3' Perc LF L
8	Piano FX Pedal On L	46	E.Piano Vintage mf	84	16' 8' 51/3' Perc LF R
9	Piano FX Pedal On R	47	E.Piano Vintage f	85	16' 8' 51/3' Perc LS L
10	Piano FX Pedal Off L	48	E.Piano Vintage ff	86	16' 8' 51/3' Perc LS R
11	Piano FX Pedal Off R	49	E.Piano Vintage fff	87	Theater Organ 1
12	Piano FX Key Off L	50	E.Piano Vintage Koff	88	Theater Organ 2
13	Piano FX Key Off R	51	E.Piano Wurly Soft	89	50s E.Organ Bright
14	AcousticPiano L	52	E.Piano Wurly Hard	90	50s E.Organ Dark
15	AcousticPiano R	53	E.Piano Pad 1	91	E.Organ CX 3
16	Piano M1	54	E.Piano Pad 1LP	92	E.Organ Perc. O1W
17	E.GrandPiano	55	E.Piano Pad 2	93	E.Organ Fast Click
18	E.Piano FM 1	56	Clavi 1	94	E.Organ Perc. 1
19	E.Piano FM 1LP	57	Clavi 2	95	E.Organ Perc. 2
20	E.Piano FM 2	58	Clavi 3	96	E.Organ Perc. 3
21	E.Piano PO mp	59	Clavi 4	97	E.Organ Perc. 4
22	E.Piano PO mf	60	Clavinet GM	98	Organ 1 M1
23	E.Piano PO f	61	Harpsichord	99	Organ 2 M1
24	E.Piano PO f+	62	Harpsichord Key off	100	Organ 1
25	E.Piano PO ff	63	Gospel Organ Slow L	101	Organ 2
26	E.Piano PO ff+	64	Gospel Organ Slow R	102	Organ 2LP
27	E.Piano PO fff	65	Gospel Organ Fast L	103	Organ 3 Jazz
28	E.Piano PO Kof p	66	Gospel Organ Fast R	104	BX3 & Perc. 3rd
29	E.Piano PO Kof f	67	16' 8' LF L	105	E.Organ Vox
30	E.Piano Rx KON L	68	16' 8' LF R	106	E.Organ Soft
31	E.Piano Rx KON R	69	16' 8' LS L	107	E.Organ Full
32	E.Piano Rx KOF L	70	16' 8' LS R	108	E.Organ Dist
33	E.Piano Rx KOF R	71	16' 8' 51/3 LF L	109	Rotary Organ 1
34	E.Piano Suit Bright mp	72	16' 8' 51/3 LF R	110	Rotary Organ 1LP
35	E.Piano Suit Bright mf	73	16' 8' 51/3 LS L	111	Rotary Organ 2
36	E.Piano Suit Bright f	74	16' 8' 51/3 LS R	112	Super BX3
37	E.Piano Dyno mf	75	4' 22/3' 2' LF L	113	Super BX3LP

114	Rotor Noise LF L	159	Flute Frull	204	Tenor Sax mf Vib
115	Rotor Noise LF R	160	Flute Voice	205	Tenor Sax f Vib
116	Rotor Noise LS L	161	Flute Jazz	206	Tenor Sax ff Vib
117	Rotor Noise LS R	162	Flute Vibrato	207	Tenor Sax Glissando
118	H Organ Leakage	163	Flute Attack p	208	Tenor Sax Falls
119	H Organ 2nd Harmonic	164	Flute Attack f	209	Tenor Sax mf Straight
120	H Organ Click Kon	165	Piccolo	210	Tenor Sax Riff Up
121	H Organ Click Koff	166	Pan Flute	211	Tenor Sax Riff Down
122	ON-Click (Organ)	167	Pan Flute Attack	212	Tenor Sax Vibrato
123	OFF-Click (Organ)	168	Tin Whistle	213	Tenor Sax Expressive
124	Pipe Flute L	169	Tin Whistle Voice	214	Tenor Sax mp
125	Pipe Flute R	170	Tin Whistle Attack	215	Tenor Sax mf
126	Pipe Positive	171	Whistle Gliss	216	Tenor Sax Straight
127	Pipe Mixture	172	Whistle No Vibr	217	Tenor Sax M1
128	Pipe Full 1 L	173	Whistle Sfz Vibr	218	Tenor Sax GM
129	Pipe Full 1 R	174	Whistle Sfz No Vibr	219	Alto Sax Vibrato1
130	Pipe Full 2	175	Whistle Slow Atk Vibr	220	Alto Sax Vibrato2
131	E.Organ Church	176	Whistle Breath	221	Alto Sax Vibrato2 Drive
132	Music Box	177	Shakuhachi	222	Alto Sax p
133	Music BoxLP	178	Shakuhachi Atk	223	Alto Sax mf
134	Kalimba	179	Shakuhachi Mid	224	Alto Sax GM
135	Kalimba GM	180	Shakuhachi High	225	Alto Sax Growl
136	Marimba	181	Bottle	226	Soprano Sax Vibrato
137	MarimbaLP	182	Bottlizer	227	Soprano Sax Straight
138	Xylophone	183	Shanai GM	228	Soprano Sax GM
139	Balaphone	184	Recorder	229	Sax Family Vibrato
140	Vibraphone1	185	Ocarina	230	Sax key on
141	Vibraphone1LP	186	Clarinet 1 Vibrato p	231	Sax key off
142	Vibraphone2	187	Clarinet 1 Vibrato f	232	Sax breath
143	Celesta	188	Clarinet 1 GlissUp	233	Musette 1
144	Celesta GM	189	Clarinet 1 Fall	234	Musette 2
145	CelestaLP	190	Clarinet 2	235	Musette 2LP
146	Glockenspiel	191	Clarinet 3	236	Musette 3L
147	GlockenspielLP	192	DoubleReed M1	237	Musette 3 R
148	Tubular Bell	193	Oboe 1 Vibrato	238	Accordion 16'
149	Log Drum	194	Oboe 2 Straight	239	Accordion 16' OrigTune
150	Steel Drum Hard	195	Oboe key noises	240	Accordion 8'
151	Steel Drum GM	196	Oboe get a breath	241	Accordion 8' OrigTune
152	Steel Drum HardLP	197	English Horn	242	Accordion 4'
153	Gamelan	198	Bassoon	243	Accordion 4' OrigTune
154	FM Bell	199	Baritone Sax mf	244	Accordion preset 1
155	Flute	200	Baritone Sax f	245	Accordion preset 2
156	Flute Falls	201	Baritone Sax Growl	246	Accordion Bassoon
157	Flute Gliss Up	202	Baritone Sax GM	247	Accordion Clarinet
158	Flute Gliss Down	203	Tenor Sax p Vib	248	Accordion Bandoneon

249	Accordion Volkst.	294	2 Trombones mfR	339	Voice Male Dah
250	Accordion Bass	295	2 Trombones fL	340	Voice Scat Buh
251	Accordion Noise KeyOn	296	2 Trombones fR	341	Voice Scat Duh
252	Accordion Noise KeyOff	297	Classic Trumpet p	342	Voice Scat Bah
253	Accordion Change Voice	298	Classic Trumpet mf	343	Voice Scat Dah
254	Harmonica 1	299	Pop Trumpet mf	344	Voice Choir
255	Harmonica 1 Fall	300	Pop Trumpet f	345	Voice Hoo
256	Harmonica 2	301	Trumpet Expr.	346	Voice Pop Ooh
257	Harmonica 3 Wah	302	Trumpet Slow mp	347	Voice Pop Ah
258	Melodica	303	Trumpet Slow f	348	Voice Doo
259	MelodicaKey On	304	Trumpet GM	349	Voice DooLP
260	MelodicaKey Off	305	Trumpet Tonguing mp	350	Violin1 Classic
261	Highland Bag Pipes	306	Trumpet Tonguing f	351	Violin1 Gliss Up
262	Highland Drones	307	Trumpet Medium	352	Violin1 Gliss Dw
263	Uilleann Pipes	308	Trumpet Overblown	353	Violin1 Strings free
264	Bag Pipes	309	Trumpet Muted	354	Violin1 Trill Up
265	Bag Pipes GM	310	Trumpet Muted GM	355	Violin 2 Solo Vibrato
266	French Horn T1	311	Trumpet Wah wah	356	Violin 2 Straight
267	French Horn Ensemble	312	Trumpet WDH Vib	357	Violin GM
268	French Horns GM	313	Trumpet WDH Shakes	358	Fiddle GM
269	Tenor Horn	314	Trumpet WDH Shakes Atk	359	Viola Expressive mf
270	Flugel Horn Vibrato	315	Trumpet WDH Shakes Rel	360	Viola Expressive f
271	Flugel Horn M1	316	Trumpet Doit	361	Viola GM
272	Tuba f	317	Trumpet Fall	362	Cello & Contrabass
273	Tuba ff	318	2 Trumpets mpL	363	Cello GM
274	Tuba GM	319	2 Trumpets mpR	364	Violin & Cello
275	Tuba Bariton Attack	320	2 Trumpets fL	365	Strings Quartet Vibrato1
276	Trombone 1 mf	321	2 Trumpets fR	366	Strings Quartet Vibrato2
277	Trombone 1 f	322	Brass Ensemble Stereo L	367	Pizzicato
278	Trombone 1 ff	323	Brass Ensemble Stereo R	368	Strings Ensemble St L
279	Trombone 1 Gliss Up	324	Brass Ensemble 1	369	Strings Ensemble St R
280	Trombone 1 Fall	325	Brass Ensemble 2	370	Strings Ensemble GM L
281	Trombone 1 Smear	326	Brass Ensemble 2LP	371	Strings Ensemble GM R
282	Trombone 1 Smear Atk	327	Brass Ensemble GM	372	Strings Ensemble Mono
283	Trombone 2 Vibrato	328	Soprano Voice	373	Strings Ensemble Tremolo
284	Trombone 3 mf	329	Soprano Voice AD	374	Pizzicato Ensemble
285	Trombone 3 f	330	Soprano Voice 5thDW	375	Harp Stereo L
286	Trombone 4 Soft	331	Soprano Voice 4thUP	376	Harp Stereo R
287	Trombone 4 Bright	332	Voice Female Wuh	377	Harp Atk L
288	Trombone 5 Straight fff	333	Voice Female Woh	378	Harp Atk R
289	Trombone Slur Up	334	Voice Female Wah	379	Harp Mono
290	Trombone Fall	335	Voice Female Dah	380	Ac.Gtr muted p L
291	Trombone GM	336	Voice Male Wuh	381	Ac.Gtr muted p R
292	Trombone Muted	337	Voice Male Woh	382	Ac.Gtr muted f L
293	2 Trombones mfL	338	Voice Male Wah	383	Ac.Gtr muted f R

384	Ac.Gtr Dwn1 L	429	Nylon Gtr1 Slide p R	474	El. Guitar Tel Mid p
385	Ac.Gtr Dwn1 R	430	Nylon Gtr1 Slide f L	475	El. Guitar Tel Mid mf
386	Ac.Gtr Dwn2 L	431	Nylon Gtr1 Slide f R	476	El. Guitar Tel Mid f
387	Ac.Gtr Dwn2 R	432	Nylon Gtr1 Harmonics L	477	El. Guitar Tel Bridge p
388	Ac.Gtr Dwn3 L	433	Nylon Gtr1 Harmonics R	478	El. Guitar Tel Bridge mf
389	Ac.Gtr Dwn3 R	434	Nylon Gtr2 p	479	El. Guitar Tel Bridge f
390	Ac.Gtr SlideHT Up p L	435	Nylon Gtr2 mf	480	El. Guitar Tel Mt 5th pp
391	Ac.Gtr SlideHT Up p R	436	Nylon Gtr2 f	481	El. Guitar Tel Mt 5th p
392	Ac.Gtr SlideHT Up f L	437	Nylon Gtr2 Atk	482	El. Guitar Tel Mt 5th mf
393	Ac.Gtr SlideHT Up f R	438	Nylon Gtr2 GM	483	El. Guitar Tel Mt 5th f
394	Ac.Gtr Harmonics L	439	Stra Pos2 MtS1	484	El. Guitar Tel Mt 5th ff
395	Ac.Gtr Harmonics R	440	Stra Pos2 MtS2	485	El. Guitar Tel Mt 5th Ko
396	Ac.Gtr RX noises L	441	Stra Pos2 MtS3	486	El. Guitar Clean Str p
397	Ac.Gtr RX noises R	442	Stra Pos2 MtS4	487	El. Guitar Clean Str f
398	Ac.Gtr finger off L	443	Stra Pos2 MtS5	488	El. Guitar Clean Mute
399	Ac.Gtr finger off R	444	Stra Pos2 MtS6	489	El. Guitar Clean Dead
400	Steel Gtr 1 Pick p	445	Stra Pos2 MtL1	490	El. Guitar Clean Slap
401	Steel Gtr 1 Pick mf	446	Stra Pos2 MtL2	491	El. Guitar Clean Slide
402	Steel Gtr 1 Pick f	447	Stra Pos2 MtL3	492	El. Guitar Clean GM
403	Steel Gtr 1 Mute	448	Stra Pos2 MtL4	493	El. Guitar Fret Noise GM
404	Steel Gtr 1 Slide	449	Stra Pos2 dw1	494	El. Guitar Cut Noise GM
405	Steel Gtr 2 p	450	Stra Pos2 dw2	495	El. Guitar Le Neck
406	Steel Gtr 2 mf	451	Stra Pos2 dw3	496	El. Guitar Le Bridge
407	Steel Gtr 2 f	452	Stra Pos2 dw4	497	El. Guitar Le Mute p
408	Steel Gtr 2 Slap	453	Stra Pos2 dw5	498	El. Guitar Le Mute mf
409	Steel Gtr 2 Slide	454	Stra Pos2 up1	499	El. Guitar Le Ghost1
410	Steel Gtr 12 Strings	455	Stra Pos2 up2	500	El. Guitar Le Ghost2
411	Steel Gtr Harmonics 1	456	Stra Pos2 up3	501	El. Guitar Harmonics
412	Steel Gtr Harmonics 2	457	Stra Pos2 up4	502	El. Guitar Gliss Down
413	Steel Gtr Noise	458	Stra Pos2 up5	503	El. Guitar Gliss Up
414	Guitar Fret Noise Off	459	Stra Pos2 SlideHT p	504	El. Guitar Noise
415	Guitar Noise Off	460	Stra Pos2 SlideHT f	505	El. Guitar Short Noise
416	Guitar Body	461	Stra Pos2 Harm 12	506	El. Guitar Fret Noise
417	Guitar Noise Attack Off	462	Stra Pos2 Harm 7	507	El. Guitar Les P.
418	Nylon Gtr1 p L	463	Stra Pos2 Harm 5	508	Jazz Guitar1
419	Nylon Gtr1 p R	464	Stra Pop2 Ghost UP	509	Jazz Guitar2
420	Nylon Gtr1 mf1 L	465	Stra Pop2 Ghost DW	510	Jazz Gib mellow p
421	Nylon Gtr1 mf1 R	466	Stra Pop2 Fret Nuances	511	Jazz Gib mellow mf
422	Nylon Gtr1 mf2 L	467	Stra Pop2 Key Off	512	Jazz Gib mellow f
423	Nylon Gtr1 mf2 R	468	Stra RX1 (Old Compatib)	513	Pedal Steel Guitar
424	Nylon Gtr1 mf3 L	469	Stra RX2	514	Resonator Guitar
425	Nylon Gtr1 mf3 R	470	El. Guitar Stra 54 p	515	Vox Wah Guitar
426	Nylon Gtr1 f L	471	El. Guitar Stra 54 mf	516	Overdrive GM
427	Nylon Gtr1 f R	472	El. Guitar Stra 54 f	517	Dist. Guitar
428	Nylon Gtr1 Slide p L	473	El. Guitar Stra 54 Slide	518	Dist. Guitar GM

519	Dist. Guitar1 Harmo.	564	E.Bass2 RH Stop	609	BouzoukiLP
520	Gtr Harmonic GM	565	E.Bass2 Harmo.	610	Mandolin Dw mf L
521	Dist. Guitar2 Harmo P1	566	E.Bass3 p	611	Mandolin Dw mf R
522	Dist. Guitar2 Harmo P2	567	E.Bass3 mf	612	Mandolin Dw f L
523	Dist. Guitar2 Mute1	568	E.Bass3 f Slap	613	Mandolin Dw f R
524	Dist. Guitar2 Mute2	569	E.Bass4 Pick	614	Mandolin Up L
525	El. Guitar DistMuted p	570	E.Bass4 Harmo.	615	Mandolin Up R
526	El. Guitar DistMuted mp	571	E.Bass4 Slap	616	Mandolin
527	El. Guitar PowerChord1	572	E.Bass4 SlapHar	617	MandolinLP
528	El. Guitar PowerChord2	573	E.Bass4 LH Mute	618	Mandolin Tremolo
529	El. Guitar PowerChord3	574	E.Bass4 RH Mute	619	Mandolin Ensemble
530	Ac.Bass Natural	575	E.Bass5 Finger	620	Banjo
531	Ac.Bass Natural Key Off	576	E.Bass6 Finger	621	Banjo GM
532	Ac.Bass Natural Ghost	577	E.Bass6 FingerLP	622	BanjoLP
533	Acoustic Bass1	578	E.Bass7 Finger	623	Cavaquino p
534	Acoustic Bass2 mf	579	E.Bass8 Pick	624	Cavaquino mf
535	Acoustic Bass2 f	580	E.Bass9 Pick Muted1	625	Cavaquino f
536	Acoustic Bass3 mp	581	E.Bass9 Pick Muted2	626	Ukulele
537	Acoustic Bass3 mp VAR	582	E.Bass9 Pick	627	Shamisen
538	Acoustic Bass3 mf	583	E.Bass9 PickLP	628	Shamisen GM
539	Acoustic Bass3 mf VAR	584	E.Bass10 Thumb	629	Koto
540	Acoustic Bass3 f	585	E.Bass11 SlapThumb	630	Koto GM
541	Acoustic Bass3 f VAR	586	E.Bass11 SlapThumbLP	631	M.E. Oud
542	Acoustic Bass GM	587	E.Bass Gliss	632	M.E. Oud Tek
543	Acoustic Bass RX Noises	588	E.Bass Noise1	633	M.E. Kanoun1
544	Bass Prec FW Finger	589	E.Bass Noise2	634	M.E. Kanoun2
545	Bass Prec RW Finger	590	E.Bass Harmonics	635	M.E. Kanoun Tremolo
546	Bass Prec RW FingerDeads	591	E.Bass HarmonicsLP	636	M.E. Baglama1
547	Bass Prec Pick Open mf	592	E.Bass Fretless 1	637	M.E. Baglama2
548	Bass Prec Pick Open f	593	E.Bass Fretless 2	638	M.E. Zurna
549	Bass Prec Pick Dead	594	Finger Bass GM	639	M.E. Klarnet Tek
550	Bass Sray Finger	595	Picked Bass GM	640	M.E. Klarnet
551	Bass Sray Harmonics	596	Slap Bass1 GM	641	M.E. Nay
552	Bass Sray Deads	597	Slap Bass2 GM	642	Mouth Harp1
553	Bass Sray HandNoise	598	Fretless Bass GM	643	Mouth Harp2
554	Bass Almb Fingered mf	599	Sitar 1	644	Mouth Harp3
555	Bass Almb Fingered f	600	Sitar2	645	Mouth Harp4
556	Bass Fjazz Fingered	601	Sitar GM	646	Mouth Harp5
557	Bass Fjazz pickmute mf	602	Sitar & Tambura	647	Syn Flute Pad
558	Bass Fjazz pickmute f	603	Zither	648	Syn Bass Reso
559	Bass Fjazz Ghost	604	Santur	649	Syn Bass FM1
560	E.Bass1 Finger	605	SanturLP	650	Syn Bass FM1LP
561	E.Bass2 P.B.1	606	Tambura	651	Syn Bass FM2
562	E.Bass2 P.B.2	607	TamburaLP	652	Syn Bass FM2LP
563	E.Bass2 LH Stop	608	Bouzouki	653	Syn Bass TB

654 R&B Saw Bass	699 Square MG	744 Scream
655 R&B Square Bass	700 Square JP	745 Punch
656 Chrom Res	701 Triangle MG	746 Heart Beat
657 NextDance	702 Ramp	747 Footstep 1
658 Detuned Super	703 Ramp MG	748 Footstep2
659 Detuned PWM	704 Sine	749 Door Creak
660 Synth Brass	705 DWGS Syn Sine1	750 Door Slam
661 Pop Synth	706 DWGS Syn Sine2	751 Car Engine
662 An.Strings1	707 DWGS Organ1	752 Car EngineLP
663 An.Strings2	708 DWGS Organ2	753 Car Stop
664 Analog Vintage	709 DWGS Bell1	754 Car Pass
665 White Pad	710 DWGS Bell2	755 Car Crash
666 N1 Air Vox	711 DWGS Bell3	756 Train
667 SynthBell	712 DWGS Bell4	757 Helicopter
668 Ether Bell	713 DWGS Clav.	758 Gun Shot
669 Ether BellLP	714 DWGS Digi1	759 Machine Gun
670 Lore	715 DWGS Digi2	760 Laser Gun
671 Lore NT	716 DWGS Wire1	761 Explosion
672 Space Lore	717 DWGS Wire2	762 Wind
673 Wave Sweep1	718 DWGS Sync1	763 Chinese Gong
674 Wave Sweep2	719 DWGS Sync2	764 Crash
675 Wave Sweep3	720 DWGS Sync3	765 Crash Reverse
676 Syn Ghostly	721 Orchestra Hit 1	766 Crash Reverse GM
677 Ghost	722 Orchestra Hit 2	767 Orchestra Crash
678 Syn Air Pad	723 Orchestra Hit GM L	768 Ride Jazz
679 Dream Str	724 Orchestra Hit GM R	769 Ride Edge1
680 Syn AirVortex	725 Band Hit	770 Ride Edge2
681 Syn Palawan	726 Impact Hit	771 HiHat Closed
682 Syn Clicker	727 Brass Fall	772 88 HiHat Open
683 Cricket Spectrum	728 Vibe Chord	773 88 Cowbell
684 Noise1	729 Zap1	774 88 Tom
685 Noise2	730 Zap2	775 88 Conga
686 Noise Pad	731 Stadium	776 88 Crash
687 Swish Terra	732 Applause	777 Tom
688 Gamelan XEQ	733 Birds1	778 Tom Brush
689 Saw1	734 Birds2	779 Tom Process
690 Saw2	735 Crickets	780 Electric Tom
691 Saw3	736 Church Bell	781 Melodic Tom GM
692 Pulse 02%	737 Thunder	782 Flexatone
693 Pulse 05%	738 Stream	783 Tambourine
694 Pulse 08%	739 Bubble	784 Agogo Bell
695 Pulse 16%	740 Dog	785 Meditation Tree
696 Pulse 33%	741 Gallop	786 Marc Tree
697 Pulse 40%	742 Laughing	787 Marc TreeLP
698 Square	743 Telephone Ring	788 Rain Stick

789	Cowbell	805	Dumbek - Djambe - Udu	821	Stereo Snare1 L
790	Castanet	806	Caxixi	822	Stereo Snare1 R
791	Temple Blocks	807	Tabla & Baya	823	Stereo Snare2 L
792	Orchestra BD	808	WoodBlock & Castanet	824	Stereo Snare2 R
793	Timpani	809	Mix Latin Percussion	825	FX SD Large Hall1 L
794	Taiko	810	Kangaroo	826	FX SD Large Hall1 R
795	Djembe Open	811	DJ Eddie Set	827	FX SD Large Hall2 L
796	Djembe Mute	812	Claps Natural Set1 L	828	FX SD Large Hall2 R
797	Conga	813	Claps Natural Set1 R	829	FX Rim Large Hall1 L
798	Quinto & Bongo	814	Claps Natural Set2 L	830	FX Rim Large Hall1 R
799	Okonkolo	815	Claps Natural Set2 R	831	FX Rim Large Hall2 L
800	Timbales	816	Claps Natural Set3 L	832	FX Rim Large Hall2 R
801	Cowbell & Clave	817	Claps Natural Set3 R	833	Click
802	Cabasa	818	Snare Ghost	834	Empty
803	Shaker	819	Stereo Snares1&2 L		
804	Cabasa & Shaker	820	Stereo Snares1&2 R		

Drum Samples

The following table contains all Pa900 Factory Drum Samples.

#	Name	Family
0	BD 24x14	Bass Drum
1	BD 24x14 GM	Bass Drum
2	BD 26 inch Open	Bass Drum
3	BD 26 inch Open GM	Bass Drum
4	BD Pop1	Bass Drum
5	BD Pop2	Bass Drum
6	BD Acoustic1 p	Bass Drum
7	BD Acoustic1 mf	Bass Drum
8	BD Acoustic1 f	Bass Drum
9	BD Acoustic2 mf	Bass Drum
10	BD Acoustic2 mf GM	Bass Drum
11	BD Acoustic2 f	Bass Drum
12	BD Acoustic2 f GM	Bass Drum
13	BD open p	Bass Drum
14	BD open mf	Bass Drum
15	BD open f	Bass Drum
16	BD Peak	Bass Drum
17	BD Dry1	Bass Drum
18	BD Dry2	Bass Drum
19	BD Dry3	Bass Drum
20	BD Normal	Bass Drum
21	BD SoftRoom	Bass Drum
22	BD Jazz	Bass Drum
23	BD Jazz GM	Bass Drum
24	BD Pillow	Bass Drum
25	BD Woofers	Bass Drum
26	BD MondoKill	Bass Drum
27	BD Terminator	Bass Drum
28	BD Tubby	Bass Drum
29	BD Gated	Bass Drum
30	BD Tight	Bass Drum
31	BD Squash	Bass Drum
32	BD Soul1	Bass Drum
33	BD Soul2	Bass Drum
34	BD Soul3 dist	Bass Drum
35	BD Soul4 noise	Bass Drum
36	BD Soul5 Long	Bass Drum
37	BD Soul6	Bass Drum
38	BD Dance1	Bass Drum
39	BD Dance2	Bass Drum
40	BD Dance3	Bass Drum
41	BD House1	Bass Drum
42	BD House2	Bass Drum
43	BD House3	Bass Drum
44	BD House4	Bass Drum
45	BD House5	Bass Drum
46	BD Liquid	Bass Drum

#	Name	Family
47	BD Techno1	Bass Drum
48	BD Techno2	Bass Drum
49	BD Hip1	Bass Drum
50	BD Hip2	Bass Drum
51	BD Hip3	Bass Drum
52	BD Hip4	Bass Drum
53	BD Kick1	Bass Drum
54	BD Kick2	Bass Drum
55	Electro Kick	Bass Drum
56	BD Ambient	Bass Drum
57	BD Ambient Crackle	Bass Drum
58	BD Ambient Rocker	Bass Drum
59	BD Pop	Bass Drum
60	BD Deep	Bass Drum
61	BD Deep GM	Bass Drum
62	BD Klanger	Bass Drum
63	BD Electribe01	Bass Drum
64	BD Electribe02	Bass Drum
65	BD Electribe03	Bass Drum
66	BD Electribe04	Bass Drum
67	BD Electribe05	Bass Drum
68	BD Electribe06	Bass Drum
69	BD Electribe07	Bass Drum
70	BD Electribe08	Bass Drum
71	BD Electribe09	Bass Drum
72	BD Electribe10	Bass Drum
73	BD Electribe11	Bass Drum
74	BD Electribe12	Bass Drum
75	BD Electribe13	Bass Drum
76	BD Electribe14	Bass Drum
77	BD Electribe15	Bass Drum
78	BD Electribe16	Bass Drum
79	BD Electribe17	Bass Drum
80	Syn. BD1	Bass Drum
81	Syn. BD2	Bass Drum
82	Syn. BD3	Bass Drum
83	Syn. BD4	Bass Drum
84	Syn. BD Buzz	Bass Drum
85	BD Orchestra	Bass Drum
86	BD Orchestra GM	Bass Drum
87	Timpani	Bass Drum
88	SD LdwVintage S+Rim p	Snare Drum
89	SD LdwVintage S+Rim mf	Snare Drum
90	SD LdwVintage S+Rim f	Snare Drum
91	SD Pop1 p GM	Snare Drum
92	SD Pop1 mf GM	Snare Drum
93	SD Pop1 f GM	Snare Drum
94	SD Pop1 +Rim mf GM	Snare Drum
95	SD Pop1 +Rim f GM	Snare Drum
96	SD Black	Snare Drum

#	Name	Family
97	SD S Gate1 GM	Snare Drum
98	SD S Gate2	Snare Drum
99	SD Wood1 p	Snare Drum
100	SD Wood1 mf	Snare Drum
101	SD Wood1 f	Snare Drum
102	SD Wood2 pp	Snare Drum
103	SD Wood2 p	Snare Drum
104	SD Wood2 mf	Snare Drum
105	SD Wood2 f	Snare Drum
106	SD Piccolo1 pp	Snare Drum
107	SD Piccolo1 p	Snare Drum
108	SD Piccolo1 mf	Snare Drum
109	SD Piccolo1 f	Snare Drum
110	SD Piccolo2 pp	Snare Drum
111	SD Piccolo2 p	Snare Drum
112	SD Piccolo2 mf	Snare Drum
113	SD Piccolo2 f	Snare Drum
114	SD Solid1 p	Snare Drum
115	SD Solid1 mf	Snare Drum
116	SD Solid1 f	Snare Drum
117	SD Solid2 p	Snare Drum
118	SD Solid2 mf	Snare Drum
119	SD Solid2 f	Snare Drum
120	SD Maple1 pp	Snare Drum
121	SD Maple1 p	Snare Drum
122	SD Maple1 mp	Snare Drum
123	SD Maple1 mf	Snare Drum
124	SD Maple1 f	Snare Drum
125	SD Maple1 ff	Snare Drum
126	SD Maple2 pp	Snare Drum
127	SD Maple2 p	Snare Drum
128	SD Maple2 mp	Snare Drum
129	SD Maple2 mf	Snare Drum
130	SD Maple2 f	Snare Drum
131	SD Maple2 ff	Snare Drum
132	SD Brass1 p	Snare Drum
133	SD Brass1 mf	Snare Drum
134	SD Brass1 f	Snare Drum
135	SD Brass2 p	Snare Drum
136	SD Brass2 mf	Snare Drum
137	SD Brass2 f	Snare Drum
138	SD Roll	Snare Drum
139	SD Ghost Roll	Snare Drum
140	SD Ghost p	Snare Drum
141	SD Ghost f	Snare Drum
142	SD Snr Ghost1 a	Snare Drum
143	SD Snr Ghost1 b	Snare Drum
144	SD Snr Ghost2 a	Snare Drum
145	SD Snr Ghost2 b	Snare Drum
146	SD Snr Ghost2 c	Snare Drum

#	Name	Family
147	SD Snr Signature p	Snare Drum
148	SD Snr Signature mf	Snare Drum
149	SD Snr Signature f	Snare Drum
150	SD Snr Signature Rim mf	Snare Drum
151	SD Snr Signature Rim f	Snare Drum
152	SD Snr Signature Rim1	Snare Drum
153	SD Snr Signature Rim2	Snare Drum
154	SD J Std+Rim p	Snare Drum
155	SD J Std+Rim mf	Snare Drum
156	SD J Std+Rim f	Snare Drum
157	SD Dry1	Snare Drum
158	SD Dry2	Snare Drum
159	SD Dry3	Snare Drum
160	SD Full Room	Snare Drum
161	SD Off Center	Snare Drum
162	SD Jazz Ring	Snare Drum
163	SD Amb.Piccolo	Snare Drum
164	SD Paper	Snare Drum
165	SD Big Rock	Snare Drum
166	SD Yowie	Snare Drum
167	SD Trinity1	Snare Drum
168	SD Trinity2	Snare Drum
169	SD Stereo Gate	Snare Drum
170	SD Stereo Gate GM	Snare Drum
171	SD Processed	Snare Drum
172	SD Processed GM	Snare Drum
173	SD Cracker Room	Snare Drum
174	SD El. Funk1	Snare Drum
175	SD El. Funk2	Snare Drum
176	SD El. Funk3	Snare Drum
177	SD Dance01	Snare Drum
178	SD Dance02	Snare Drum
179	SD Dance03	Snare Drum
180	SD Dance04	Snare Drum
181	SD Dance05	Snare Drum
182	SD Dance06	Snare Drum
183	SD Dance07	Snare Drum
184	SD Dance08	Snare Drum
185	SD Dance09	Snare Drum
186	SD Dance10	Snare Drum
187	SD Dance11	Snare Drum
188	SD Dance12	Snare Drum
189	SD Dance13	Snare Drum
190	SD Dance14	Snare Drum
191	SD Dance15	Snare Drum
192	SD Dance16	Snare Drum
193	SD Dance17	Snare Drum
194	SD Dance18	Snare Drum
195	SD Dance19	Snare Drum
196	SD Dance20	Snare Drum
197	SD Dance21	Snare Drum
198	SD Dance22	Snare Drum
199	SD Dance23	Snare Drum

#	Name	Family
200	SD Dance23 GM	Snare Drum
201	SD Dance24	Snare Drum
202	SD House1	Snare Drum
203	SD House2	Snare Drum
204	SD House3	Snare Drum
205	SD House4	Snare Drum
206	SD BeatBox	Snare Drum
207	SD Small	Snare Drum
208	SD Rap	Snare Drum
209	SD Noise	Snare Drum
210	SD Reverse	Snare Drum
211	SD Hip1	Snare Drum
212	SD Hip2	Snare Drum
213	SD Hip3	Snare Drum
214	SD Hip4	Snare Drum
215	SD Hip5	Snare Drum
216	SD Hip6	Snare Drum
217	SD Ringy	Snare Drum
218	SD Tiny	Snare Drum
219	SD Vintage1	Snare Drum
220	SD Vintage2	Snare Drum
221	SD Vintage3	Snare Drum
222	SD Vintage4	Snare Drum
223	SD Vintage5	Snare Drum
224	SD Vintage6	Snare Drum
225	SD AmbiHop	Snare Drum
226	SD Brassier	Snare Drum
227	SD Chili	Snare Drum
228	SD Whopper	Snare Drum
229	SD Syn.1	Snare Drum
230	SD Syn.2	Snare Drum
231	SD Syn.3	Snare Drum
232	SD Syn.4	Snare Drum
233	SD Electro	Snare Drum
234	SD Orchestra	Snare Drum
235	SD Orch. Roll	Snare Drum
236	SD JazzBrush1	Snare Drum
237	SD JazzBrush2	Snare Drum
238	SD Brush1 (swirl1)	Snare Drum
239	SD Brush1 (swirl2)	Snare Drum
240	SD Brush1 (swirl3)	Snare Drum
241	SD Brush1 (swirl4)	Snare Drum
242	SD Brush1	Snare Drum
243	SD Brush2 (ghost1)	Snare Drum
244	SD Brush2 (ghost2)	Snare Drum
245	SD Brush2 (ghost3)	Snare Drum
246	SD Brush2	Snare Drum
247	SD Brush2 (fill) 4 shots	Snare Drum
248	SD Brush2 (fill) 3 shots	Snare Drum
249	SD Brush2 (fill) 2 shots	Snare Drum
250	SD Brush3 Hit	Snare Drum
251	SD Brush3 Tap1	Snare Drum
252	SD Brush3 Tap2	Snare Drum

#	Name	Family
253	SD Brush3 Swirl	Snare Drum
254	SD FX Large Hall1	Snare Drum
255	SD FX Large Hall2	Snare Drum
256	Rim Signature Hi	Snare Drum
257	Rim Signature Mid	Snare Drum
258	Rim Signature Low	Snare Drum
259	Rim Shot p	Snare Drum
260	Rim Shot f	Snare Drum
261	Rim House1	Snare Drum
262	Rim House2	Snare Drum
263	Rim Synth	Snare Drum
264	Rim Synth Click	Snare Drum
265	Rim Synth Tamb	Snare Drum
266	Rim FX Large Hall1	Snare Drum
267	Rim FX Large Hall2	Snare Drum
268	SideStick mf	Snare Drum
269	SideStick f	Snare Drum
270	SideStick Dance	Snare Drum
271	SideStick Dry	Snare Drum
272	SideStick Amb	Snare Drum
273	DrumStick Hit	Snare Drum
274	DrumStick Hit GM	Snare Drum
275	Tom R Vintage Hi	Tom
276	Tom R Vintage Mid	Tom
277	Tom R Vintage Floor	Tom
278	Tom Vintage Room Hi	Tom
279	Tom Vintage Room Mid	Tom
280	Tom Vintage Room Low	Tom
281	Tom Jazz Hi center	Tom
282	Tom Jazz Hi center GM	Tom
283	Tom Jazz Low center GM	Tom
284	Tom1 Open Hi p	Tom
285	Tom1 Open Hi p flam	Tom
286	Tom1 Open Hi f	Tom
287	Tom1 Open Hi f flam	Tom
288	Tom1 Open Mid p	Tom
289	Tom1 Open Mid p flam	Tom
290	Tom1 Open Mid f	Tom
291	Tom1 Open Mid f flam	Tom
292	Tom1 Open Low p	Tom
293	Tom1 Open Low p flam	Tom
294	Tom1 Open Low f	Tom
295	Tom1 Open Low f flam	Tom
296	Tom1 Open Floor p	Tom
297	Tom1 Open Floor p flam	Tom
298	Tom1 Open Floor f	Tom
299	Tom1 Open Floor f flam	Tom
300	Tom2 Hi p	Tom
301	Tom2 Hi f	Tom
302	Tom2 Mid p	Tom
303	Tom2 Mid f	Tom
304	Tom2 Low p	Tom
305	Tom2 Low f	Tom

#	Name	Family
306	Tom2 Floor p	Tom
307	Tom2 Floor f	Tom
308	Tom3 Hi	Tom
309	Tom3 Floor	Tom
310	Tom4 Hi	Tom
311	Tom4 Low	Tom
312	Tom4 Floor	Tom
313	Tom5 Hi	Tom
314	Tom5 Low	Tom
315	Tom6 Vintage Hi p	Tom
316	Tom6 Vintage Hi mf	Tom
317	Tom6 Vintage Hi f	Tom
318	Tom6 Vintage Mid p	Tom
319	Tom6 Vintage Mid mf	Tom
320	Tom6 Vintage Mid f	Tom
321	Tom6 Vintage Low p	Tom
322	Tom6 Vintage Low mf	Tom
323	Tom6 Vintage Low f	Tom
324	Tom Processed	Tom
325	Tom Jazz Hi	Tom
326	Tom Jazz Floor	Tom
327	Tom Brush1 (sd open)	Tom
328	Tom Brush1 (sd close)	Tom
329	Tom Brush2 (sd open)	Tom
330	Tom Brush2 (sd close)	Tom
331	Tom Brush3 Hi mf	Tom
332	Tom Brush3 Hi f	Tom
333	Tom Brush3 Hi f GM	Tom
334	Tom Brush3 Midmf	Tom
335	Tom Brush3 Mid f	Tom
336	Tom Brush3 Mid f GM	Tom
337	Tom Brush3 Low mf	Tom
338	Tom Brush3 Low f	Tom
339	Tom Brush3 Low f GM	Tom
340	Tom Brush4	Tom
341	E.Tom FM	Tom
342	E.Tom Real	Tom
343	HH1 Closed pp	Hi Hat
344	HH1 Closed p	Hi Hat
345	HH1 Closed mf	Hi Hat
346	HH1 Closed f	Hi Hat
347	HH1 Foot mp	Hi Hat
348	HH1 Foot mf	Hi Hat
349	HH1 Open mp	Hi Hat
350	HH1 Open mf	Hi Hat
351	HH2 Closed pp	Hi Hat
352	HH2 Closed p	Hi Hat
353	HH2 Closed mp	Hi Hat
354	HH2 Closed mf	Hi Hat
355	HH2 Closed f	Hi Hat
356	HH2 Closed ff	Hi Hat
357	HH2 Foot p	Hi Hat
358	HH2 Foot f	Hi Hat

#	Name	Family
359	HH2 Open p	Hi Hat
360	HH2 Open f	Hi Hat
361	HH3 Closed1	Hi Hat
362	HH3 Closed2	Hi Hat
363	HH3 Foot	Hi Hat
364	HH3 Open1	Hi Hat
365	HH3 Open2	Hi Hat
366	HH3 Sizzle	Hi Hat
367	HH4 Closed1	Hi Hat
368	HH4 Closed2	Hi Hat
369	HH4 Foot	Hi Hat
370	HH4 Foot Open	Hi Hat
371	HH4 Open	Hi Hat
372	HH Old Close1	Hi Hat
373	HH Old Open1	Hi Hat
374	HH Old TiteClose	Hi Hat
375	HH Old Close2	Hi Hat
376	HH Old Open2	Hi Hat
377	HH House Open1	Hi Hat
378	HH House Open2	Hi Hat
379	HH Hip	Hi Hat
380	HH Alpo Close	Hi Hat
381	HH Dance1	Hi Hat
382	HH Dance2	Hi Hat
383	HH Syn. Closed	Hi Hat
384	HH Syn. Open	Hi Hat
385	Ride 20' mp1	Cymbal
386	Ride 20' mp2	Cymbal
387	Ride 20' mf1	Cymbal
388	Ride 20' mf2	Cymbal
389	Ride Edge1	Cymbal
390	Ride Edge2	Cymbal
391	Ride Cup	Cymbal
392	Ride Jazz	Cymbal
393	Ride Brush1	Cymbal
394	Ride Brush2	Cymbal
395	Ride Brush3	Cymbal
396	Ride Rivet	Cymbal
397	Crash 15'edge1	Cymbal
398	Crash 15'edge2	Cymbal
399	Crash 17'edge1	Cymbal
400	Crash 17'edge2	Cymbal
401	Crash 19'open1	Cymbal
402	Crash 19'open2	Cymbal
403	Crash 1	Cymbal
404	Crash 2	Cymbal
405	Crash Reverse	Cymbal
406	Crash Dance 99	Cymbal
407	Crash DDD-1	Cymbal
408	Splash 8'edge1	Cymbal
409	Splash 8'edge2	Cymbal
410	Splash	Cymbal
411	China	Cymbal

#	Name	Family
412	Orchestra Cymbal	Cymbal
413	Finger Snaps	Latin Perc.
414	Claps1	Latin Perc.
415	Claps2	Latin Perc.
416	Claps3	Latin Perc.
417	Claps4	Latin Perc.
418	Dance Claps1	Latin Perc.
419	Dance Claps2	Latin Perc.
420	Dance Claps3	Latin Perc.
421	Dance Claps4	Latin Perc.
422	Dance Claps5	Latin Perc.
423	Dance Claps6	Latin Perc.
424	Dance Conga Lo-Open	Latin Perc.
425	Dance Conga Hi-Open	Latin Perc.
426	Dance Tambourine	Ethnic Perc.
427	Syn. Bongo1	Latin Perc.
428	Syn. Bongo2	Latin Perc.
429	Syn. Castanet	Latin Perc.
430	Syn. Shaker	Ethnic Perc.
431	Syn. Noise	SFX
432	Syn. FX1	SFX
433	Syn. FX2	SFX
434	Syn. FX3	SFX
435	Syn. FX4	SFX
436	Syn. FX5	SFX
437	Syn. Perc. Ahh	SFX
438	Boom	SFX
439	Zap1	SFX
440	Zap2	SFX
441	Vinyl Hit	SFX
442	DJ Vinyl Sliced 01	SFX
443	DJ Vinyl Sliced 02	SFX
444	DJ Vinyl Sliced 03	SFX
445	DJ Vinyl Sliced 04	SFX
446	DJ Vinyl Sliced 05	SFX
447	DJ Vinyl Sliced 06	SFX
448	DJ Vinyl Sliced 07	SFX
449	DJ Vinyl Sliced 08	SFX
450	DJ Vinyl Sliced 09	SFX
451	DJ Vinyl Sliced 10	SFX
452	DJ Vinyl Sliced 11	SFX
453	DJ Vinyl Sliced 12	SFX
454	DJ Vinyl Sliced 13	SFX
455	DJ Vinyl Sliced 14	SFX
456	DJ Vinyl Sliced 15	SFX
457	DJ Vinyl Sliced 16	SFX
458	DJ Vinyl Sliced 17	SFX
459	DJ Vinyl Sliced 18	SFX
460	DJ Vinyl Sliced 19	SFX
461	DJ Vinyl Sliced 20	SFX
462	DJ Vinyl Sliced 21	SFX
463	DJ Vinyl Sliced 22	SFX
464	DJ Vinyl Sliced 23	SFX

#	Name	Family
465	DJ Vinyl Sliced 24	SFX
466	DJ Scratch 01	SFX
467	DJ Scratch 02	SFX
468	DJ Scratch 03	SFX
469	DJ Scratch 04	SFX
470	DJ Scratch 05	SFX
471	DJ Scratch 06	SFX
472	DJ Hit Rub	SFX
473	DJ Vocal Rub1	SFX
474	DJ Vocal Rub2	SFX
475	DJ BD Rub	SFX
476	DJ SD Rub	SFX
477	Guiro Long	Latin Perc.
478	Guiro Short	Latin Perc.
479	Vibraslap	Ethnic Perc.
480	Samba Whistle	Ethnic Perc.
481	Samba Whistle Lp	Ethnic Perc.
482	Cuica Hi	Latin Perc.
483	Cuica Lo	Latin Perc.
484	Surdo Open GM	Latin Perc.
485	Surdo Mute GM	Latin Perc.
486	Tumba Open1 mf	Latin Perc.
487	Tumba Open1 f	Latin Perc.
488	Tumba Open2 mf	Latin Perc.
489	Tumba Open2 f	Latin Perc.
490	Tumba Open Flam	Latin Perc.
491	Tumba Glissando	Latin Perc.
492	Tumba Basstone	Latin Perc.
493	Tumba O.Slap Flam mf	Latin Perc.
494	Tumba O.Slap Flam f	Latin Perc.
495	Tumba Muffled	Latin Perc.
496	Conga1 Lo Basstone	Latin Perc.
497	Conga1 Lo Open mf	Latin Perc.
498	Conga1 Lo Open Slap	Latin Perc.
499	Conga1 Lo Glissando	Latin Perc.
500	Conga1 Lo Muffled	Latin Perc.
501	Conga1 Lo Closed	Latin Perc.
502	Conga1 Lo Closed Slap	Latin Perc.
503	Conga1 Lo Heel	Latin Perc.
504	Conga1 Lo Toe	Latin Perc.
505	Conga1 Hi Basstone mf	Latin Perc.
506	Conga1 Hi Basstonef	Latin Perc.
507	Conga1 Hi Open mf	Latin Perc.
508	Conga1 Hi Open Slap	Latin Perc.
509	Conga1 Hi Muffled	Latin Perc.
510	Conga1 Hi Closed	Latin Perc.
511	Conga1 Hi Closed Slap	Latin Perc.
512	Conga1 Hi Heel	Latin Perc.
513	Conga1 Hi Toe	Latin Perc.
514	Conga2 Lo Open	Latin Perc.
515	Conga2 Lo Mt Slap	Latin Perc.
516	Conga2 Lo Slap	Latin Perc.
517	Conga2 Hi Open	Latin Perc.

#	Name	Family
518	Conga2 Hi Mute	Latin Perc.
519	Conga2 Hi Mt Slap	Latin Perc.
520	Conga2 Hi Slap1	Latin Perc.
521	Conga2 Hi Slap2	Latin Perc.
522	Conga2 Heel	Latin Perc.
523	Conga2 Toe	Latin Perc.
524	Quinto1 Open	Latin Perc.
525	Quinto1 Closed	Latin Perc.
526	Quinto1 Closed Slap	Latin Perc.
527	Quinto1 Toe	Latin Perc.
528	Quinto2 Basstone	Latin Perc.
529	Quinto2 Open mp	Latin Perc.
530	Quinto2 Open Flam	Latin Perc.
531	Quinto2 Open Slap	Latin Perc.
532	Quinto2 Muffled	Latin Perc.
533	Quinto2 C.Slap Flam p	Latin Perc.
534	Quinto2 C.Slap Flam f	Latin Perc.
535	Quinto2 Heel	Latin Perc.
536	Bongo1 Lo Muffled mp	Latin Perc.
537	Bongo1 Lo Muffled f	Latin Perc.
538	Bongo1 Lo Closed	Latin Perc.
539	Bongo1 Lo Flam	Latin Perc.
540	Bongo1 Lo MuffledFlam	Latin Perc.
541	Bongo1 Lo Stick	Latin Perc.
542	Bongo1 Lo StickEdge mf	Latin Perc.
543	Bongo1 Lo StickEdgef	Latin Perc.
544	Bongo1 Lo StickBounce	Latin Perc.
545	Bongo1 Lo Fingernail	Latin Perc.
546	Bongo1 Lo Cuptone	Latin Perc.
547	Bongo1 Lo Slap	Latin Perc.
548	Bongo1 Hi Open mf	Latin Perc.
549	Bongo1 Hi Open f	Latin Perc.
550	Bongo1 Hi Pops	Latin Perc.
551	Bongo1 Hi Hightone	Latin Perc.
552	Bongo1 Hi OpenFlam	Latin Perc.
553	Bongo1 Hi Fingernail	Latin Perc.
554	Bongo1 Hi Stick	Latin Perc.
555	Bongo1 Hi StickEdge mf	Latin Perc.
556	Bongo1 Hi StickEdgef	Latin Perc.
557	Bongo1 Hi StickBounce	Latin Perc.
558	Bongo1 Hi Cuptone	Latin Perc.
559	Bongo1 Hi Slap	Latin Perc.
560	Bongo2 Lo Open a	Latin Perc.
561	Bongo2 Lo Open b	Latin Perc.
562	Bongo2 Lo Mute	Latin Perc.
563	Bongo2 Hi Open a	Latin Perc.
564	Bongo2 Hi Open b	Latin Perc.
565	Bongo2 Hi Muffled	Latin Perc.
566	Bongo2 Hi Slap	Latin Perc.
567	Bongo2 Lo Heel	Latin Perc.
568	Bongo2 Lo Muffled	Latin Perc.
569	Bongo3 Lo Open	Latin Perc.
570	Bongo3 Lo Slap	Latin Perc.

#	Name	Family
571	Bongo3 Lo Stick	Latin Perc.
572	Bongo3 Hi Open	Latin Perc.
573	Bongo3 Hi Slap	Latin Perc.
574	Bongo3 Hi Stick1	Latin Perc.
575	Bongo3 Hi Stick2	Latin Perc.
576	Okonkolo Boca Op mp	Latin Perc.
577	Okonkolo Chacha Open mp	Latin Perc.
578	Okonkolo Chacha Open mf	Latin Perc.
579	Okonkolo Chacha Open f	Latin Perc.
580	Okonkolo Chacha Open ff	Latin Perc.
581	Okonkolo Chacha Slap mp	Latin Perc.
582	Okonkolo Chacha Slap mf	Latin Perc.
583	Okonkolo Chacha Slap f	Latin Perc.
584	Baya Open	Latin Perc.
585	Baya Ghe	Latin Perc.
586	Baya GheUp a	Latin Perc.
587	Baya GheUp b	Latin Perc.
588	Baya KaPalm	Latin Perc.
589	Baya KaToe a	Latin Perc.
590	Baya KaToe b	Latin Perc.
591	Baya Nail a	Latin Perc.
592	Baya Nail b	Latin Perc.
593	Baya Nail c	Latin Perc.
594	Baya Ge	Latin Perc.
595	Baya Up	Latin Perc.
596	Baya UpDown a	Latin Perc.
597	Baya UpDown b	Latin Perc.
598	Baya Mute1	Latin Perc.
599	Baya Mute2	Latin Perc.
600	Baya Mute3	Latin Perc.
601	Tabla1 Na	Latin Perc.
602	Tabla1 Open	Latin Perc.
603	Tabla1 Tin	Latin Perc.
604	Tabla1 Mute1	Latin Perc.
605	Tabla1 Mute2	Latin Perc.
606	Tabla1 Mute3	Latin Perc.
607	Tabla2 Tin a	Latin Perc.
608	Tabla2 Tin b	Latin Perc.
609	Tabla2 Na a	Latin Perc.
610	Tabla2 Na b	Latin Perc.
611	Tabla2 Na c	Latin Perc.
612	Tabla2 Tun a	Latin Perc.
613	Tabla2 Tun b	Latin Perc.
614	Tabla2 Tele a	Latin Perc.
615	Tabla2 Tele b	Latin Perc.
616	Tabla2 Tele c	Latin Perc.
617	Tabla2 Ti a	Latin Perc.
618	Tabla2 Ti b	Latin Perc.
619	Tabla2 Ti c	Latin Perc.
620	Tabla2 Tera	Latin Perc.
621	Tsuzumi	Latin Perc.
622	Taiko Open	Latin Perc.
623	Taiko Rim	Latin Perc.

#	Name	Family
624	Timbales1 Lo Open mp	Latin Perc.
625	Timbales1 Lo Open mf	Latin Perc.
626	Timbales1 Lo Open mf GM	Latin Perc.
627	Timbales1 Lo Edge mf	Latin Perc.
628	Timbales1 Lo Edge f	Latin Perc.
629	Timbales1 Lo RimShot	Latin Perc.
630	Timbales1 Lo Abanico	Latin Perc.
631	Timbales1 Lo Roll	Latin Perc.
632	Timbales1 Lo Mute mf	Latin Perc.
633	Timbales1 Lo Mute f	Latin Perc.
634	Timbales1 Lo Paila mf	Ethnic Perc.
635	Timbales1 Lo Paila f	Ethnic Perc.
636	Timbales1 Hi Open	Latin Perc.
637	Timbales1 Hi Edge	Latin Perc.
638	Timbales1 Hi Edge GM	Latin Perc.
639	Timbales1 Hi RimShot mf	Latin Perc.
640	Timbales1 Hi RimShot f	Latin Perc.
641	Timbales1 Hi RimShot ff	Latin Perc.
642	Timbales1 Hi Abanico1	Latin Perc.
643	Timbales1 Hi Abanico2	Latin Perc.
644	Timbales1 Hi Mute	Latin Perc.
645	Timbales1 Hi Paila mf	Ethnic Perc.
646	Timbales1 Hi Paila f	Ethnic Perc.
647	Timbales2 Lo Open	Latin Perc.
648	Timbales2 Lo Mute	Latin Perc.
649	Timbales2 Lo Rim	Latin Perc.
650	Timbales2 Hi Edge	Latin Perc.
651	Timbales2 Hi Rim1	Latin Perc.
652	Timbales2 Hi Rim2	Latin Perc.
653	Timbales2 Paila	Ethnic Perc.
654	Cowbell1	Ethnic Perc.
655	Cowbell2	Ethnic Perc.
656	Cowbell3	Ethnic Perc.
657	Cowbell4 Open	Ethnic Perc.
658	Cowbell4 Mute	Ethnic Perc.
659	Cowbell5 Open a	Ethnic Perc.
660	Cowbell5 Open b	Ethnic Perc.
661	Cowbell5 Mute	Ethnic Perc.
662	Cowbell6	Ethnic Perc.
663	Agogo Bell	Ethnic Perc.
664	Chacha Bell	Ethnic Perc.
665	Mambo Bell	Ethnic Perc.
666	Recoreco short1	Ethnic Perc.
667	Recoreco short2	Ethnic Perc.
668	Recoreco long	Ethnic Perc.
669	Triangle1 Open	Ethnic Perc.
670	Triangle1 Mute	Ethnic Perc.
671	Triangle2 Open Lp	Ethnic Perc.
672	Triangle2 Closed	Ethnic Perc.
673	Sleigh Bell	Ethnic Perc.
674	Rap Sleigh Bell	Ethnic Perc.
675	Jingle Bell	Ethnic Perc.
676	Bells Open	Ethnic Perc.

#	Name	Family
677	Finger Cymbal	Ethnic Perc.
678	Marc Tree	Ethnic Perc.
679	Marc Tree GM	Ethnic Perc.
680	Marc Tree Lp	Ethnic Perc.
681	Rainstick	SFX
682	Flexatone	Ethnic Perc.
683	Chinese Gong	Cymbal
684	Claves1 Lo a	Latin Perc.
685	Claves1 Lo b	Latin Perc.
686	Claves1 Hi a	Latin Perc.
687	Claves1 Hi b	Latin Perc.
688	Claves2	Latin Perc.
689	Wood Block 1 a	Latin Perc.
690	Wood Block 1 b	Latin Perc.
691	Wood Block 2 a	Latin Perc.
692	Wood Block 2 b	Latin Perc.
693	Wood Block 3 a	Latin Perc.
694	Wood Block 3 b	Latin Perc.
695	Wood Block 4 a	Latin Perc.
696	Wood Block 4 b	Latin Perc.
697	Wood Block 5 a	Latin Perc.
698	Wood Block 5 b	Latin Perc.
699	Wood Block 6 a	Latin Perc.
700	Wood Block 6 b	Latin Perc.
701	Wood Block 7	Latin Perc.
702	Wood Block 8	Latin Perc.
703	Castanet 1 a	Latin Perc.
704	Castanet 1 b	Latin Perc.
705	Castanet 1 c	Latin Perc.
706	Castanet 2	Latin Perc.
707	Castanet Single	Latin Perc.
708	Castanet Single GM	Latin Perc.
709	Castanet Double	Latin Perc.
710	Cabasa 1 L a Down	Ethnic Perc.
711	Cabasa 1 L a Up	Ethnic Perc.
712	Cabasa 1 L b Down	Ethnic Perc.
713	Cabasa 1 L b Up	Ethnic Perc.
714	Cabasa 1 S a Down	Ethnic Perc.
715	Cabasa 1 S a Up	Ethnic Perc.
716	Cabasa 1 S b Down	Ethnic Perc.
717	Cabasa 1 S b Up	Ethnic Perc.
718	Cabasa 2 L Stack b	Ethnic Perc.
719	Cabasa 2 L Stack a	Ethnic Perc.
720	Cabasa 2 L Roll	Ethnic Perc.
721	Cabasa 2 S Stack a	Ethnic Perc.
722	Cabasa 2 S Stack b	Ethnic Perc.
723	Cabasa 2 S Roll	Ethnic Perc.
724	Cabasa 3 WS	Ethnic Perc.
725	Cabasa 3 Up	Ethnic Perc.
726	Cabasa 3 Down	Ethnic Perc.
727	Cabasa 3 Tap	Ethnic Perc.
728	Caxixi1 a	Ethnic Perc.
729	Caxixi1 b	Ethnic Perc.

#	Name	Family
730	Caxixi1 c	Ethnic Perc.
731	Caxixi2 a	Ethnic Perc.
732	Caxixi2 b	Ethnic Perc.
733	Caxixi2 c	Ethnic Perc.
734	Caxixi3 Hard	Ethnic Perc.
735	Caxixi3 Soft	Ethnic Perc.
736	Shaker1 Push a	Ethnic Perc.
737	Shaker1 Push b	Ethnic Perc.
738	Shaker1 Pull a	Ethnic Perc.
739	Shaker1 Pull b	Ethnic Perc.
740	Shaker1 Accent a	Ethnic Perc.
741	Shaker1 Accent b	Ethnic Perc.
742	Shaker1 Slow a	Ethnic Perc.
743	Shaker1 Slow b	Ethnic Perc.
744	Shaker1 Slow c	Ethnic Perc.
745	Shaker1 Roll a	Ethnic Perc.
746	Shaker1 Roll b	Ethnic Perc.
747	Shaker1 Roll c	Ethnic Perc.
748	Shaker2	Ethnic Perc.
749	Shaker3	Ethnic Perc.
750	Maracas Push	Ethnic Perc.
751	Maracas Pull	Ethnic Perc.
752	Dumbek a	Latin Perc.
753	Dumbek b	Latin Perc.
754	Dumbek c	Latin Perc.
755	Dumbek d	Latin Perc.
756	Dumbek e	Latin Perc.
757	Dumbek f	Latin Perc.
758	Dumbek g	Latin Perc.
759	Dumbek h	Latin Perc.
760	Dumbek i	Latin Perc.
761	Dumbek j	Latin Perc.
762	Dumbek k	Latin Perc.
763	Djembe L Basstone a	Latin Perc.
764	Djembe L Basstone b	Latin Perc.
765	Djembe L Basstone c	Latin Perc.
766	Djembe L Open	Latin Perc.
767	Djembe L Open Slap	Latin Perc.
768	Djembe L Closed Slap	Latin Perc.
769	Djembe S Basstone a	Latin Perc.
770	Djembe S Basstone b	Latin Perc.
771	Djembe S Basstone c	Latin Perc.
772	Djembe Open	Latin Perc.
773	Djembe Mute	Latin Perc.
774	Djembe Slap	Latin Perc.
775	Djembe S Open	Latin Perc.
776	Djembe S Open Slap a	Latin Perc.
777	Djembe S Open Slap b	Latin Perc.
778	Djembe S Closed Slap a	Latin Perc.
779	Djembe S Closed Slap b	Latin Perc.
780	Djembe S Closed Slap c	Latin Perc.
781	Djembe Bass	Latin Perc.
782	Udu Open a	Latin Perc.

#	Name	Family
783	Udu Open b	Latin Perc.
784	Udu Open c	Latin Perc.
785	Udu Open d	Latin Perc.
786	Udu Slide a	Ethnic Perc.
787	Udu Slide b	Ethnic Perc.
788	Udu Half Open a	Latin Perc.
789	Udu Half Open b	Latin Perc.
790	Udu Half Open c	Latin Perc.
791	Udu Bell a	Latin Perc.
792	Udu Bell b	Latin Perc.
793	WD Brazillia1	Snare Drum
794	WD Brazillia2	Snare Drum
795	WD Ethno SD1	Snare Drum
796	WD Ethno SD2	Snare Drum
797	WD Ethno SD3	Snare Drum
798	WD Ethno SD4	Snare Drum
799	WD Ethno SD5	Snare Drum
800	WD Ethno SD6	Snare Drum
801	WD Kangaroo1	Snare Drum
802	WD Kangaroo2	SFX
803	WD Kangaroo3	SFX
804	WD Kangaroo4	SFX
805	WD Kangaroo5	SFX
806	WD Kangaroo6	SFX
807	WD Kangaroo7	SFX
808	WD Kangaroo8	SFX
809	Tambourine Push	Ethnic Perc.
810	Tambourine Pull	Ethnic Perc.
811	Tambourine Acc1 a	Ethnic Perc.
812	Tambourine Acc1 b	Ethnic Perc.
813	Tambourine Acc2	Ethnic Perc.
814	Tambourine Mute1	Latin Perc.
815	Tambourine Mute2	Latin Perc.
816	Tambourine Open	Latin Perc.
817	M.E.1 Douf Rim Ak	Latin Perc.
818	M.E.1 Douf Tek Ak1	Latin Perc.
819	M.E.1 Douf Tek Ak2	Latin Perc.
820	M.E.1 Pand Open	Latin Perc.
821	M.E.1 Pand Pattern1	Latin Perc.
822	M.E.1 Pand Pattern2	Latin Perc.
823	M.E.1 Pand Pattern3	Latin Perc.
824	M.E.1 Pand Pattern4	Latin Perc.
825	M.E.1 Rek Dom Ak	Ethnic Perc.
826	M.E.1 Rek Jingle	Ethnic Perc.
827	M.E.1 Rik1	Latin Perc.
828	M.E.1 Rik2	Latin Perc.
829	M.E.1 Rik3	Latin Perc.
830	M.E.1 Sagat Half Open	Ethnic Perc.
831	M.E.1 Sagat Close	Ethnic Perc.
832	M.E.1 Surdo L Open	Latin Perc.
833	M.E.1 Surdo L Mute	Latin Perc.
834	M.E.1 Tabla Medium	Latin Perc.
835	M.E.1 Tabla Dom	Latin Perc.

#	Name	Family
836	M.E.1 Tabla Flam	Latin Perc.
837	M.E.1 Tabla Rim	Latin Perc.
838	M.E.1 Tabla Tak	Latin Perc.
839	M.E.1 Timbales	Ethnic Perc.
840	M.E.1 Udu f Open	Latin Perc.
841	M.E.1 Alkis	Latin Perc.
842	M.E.1 Bandir Open	Latin Perc.
843	M.E.1 Bandir Closed	Latin Perc.
844	M.E.1 Bongo Roll	Latin Perc.
845	M.E.1 Darbuka1 Tek1	Latin Perc.
846	M.E.1 Darbuka1 Tek2	Latin Perc.
847	M.E.1 Darbuka1 Open	Latin Perc.
848	M.E.1 Darbuka1 Closed	Latin Perc.
849	M.E.1 Darbuka2	Latin Perc.
850	M.E.1 Darbuka3	Latin Perc.
851	M.E.1 Darbuka4	Latin Perc.
852	M.E.1 Darbuka5 D1	Latin Perc.
853	M.E.1 Darbuka5 D2	Latin Perc.
854	M.E.1 Darbuka5 D3	Latin Perc.
855	M.E.1 Darbuka6 Mute	Latin Perc.
856	M.E.1 Darbuka6 Open	Latin Perc.
857	M.E.1 Darbuka6 Rim	Latin Perc.
858	M.E.1 Darbuka6 Dom Ak	Latin Perc.
859	M.E.1 Davul	Ethnic Perc.
860	M.E.1 Hollo1	Latin Perc.
861	M.E.1 Hollo2	Latin Perc.
862	M.E.1 Kup1	Latin Perc.
863	M.E.1 Kup2	Latin Perc.
864	M.E.1 Ramazan Davul1	Latin Perc.
865	M.E.1 Ramazan Davul2	Latin Perc.
866	M.E.1 Ramazan Davul3	Latin Perc.
867	M.E.1 Tef1	Ethnic Perc.
868	M.E.1 Tef2	Ethnic Perc.
869	M.E.1 Tef3	Ethnic Perc.
870	M.E.2 BD Kick	Bass Drum
871	M.E.2 SD	Snare Drum
872	M.E.2 Asagum	Latin Perc.
873	M.E.2 Asmatek	Latin Perc.
874	M.E.2 Bendirgum	Latin Perc.
875	M.E.2 Bendirtek1	Latin Perc.
876	M.E.2 Bendirtek2	Latin Perc.
877	M.E.2 Dm1	Latin Perc.
878	M.E.2 Findik	Latin Perc.
879	M.E.2 Gum	Latin Perc.
880	M.E.2 Hollotokat	Latin Perc.
881	M.E.2 Islik1	SFX
882	M.E.2 Islik2	SFX
883	M.E.2 Kapitalit	Latin Perc.
884	M.E.2 Kasik1	Latin Perc.
885	M.E.2 Kasik2	Latin Perc.
886	M.E.2 Kasik3	Latin Perc.
887	M.E.2 Kasik4	Latin Perc.
888	M.E.2 Kemik	Latin Perc.

#	Name	Family
889	M.E.2 Kenar	Latin Perc.
890	M.E.2 Kenartek	Latin Perc.
891	M.E.2 Ramazangum	Latin Perc.
892	M.E.2 Ramazantek	Latin Perc.
893	M.E.2 Renk	Latin Perc.
894	M.E.2 Renkbir	Latin Perc.
895	M.E.2 Renkiki	Latin Perc.
896	M.E.2 Tefacik	Latin Perc.
897	M.E.2 Tefgum	Latin Perc.
898	M.E.2 Teftek	Latin Perc.
899	M.E.2 Teftokat	Latin Perc.
900	M.E.2 Teftrill	Latin Perc.
901	M.E.2 Tefzil	Latin Perc.
902	M.E.2 Tek1	Latin Perc.
903	M.E.2 Tek2	Latin Perc.
904	M.E.2 Tekbir	Latin Perc.
905	M.E.2 Tokat	Latin Perc.
906	M.E.2 Toprgum	Latin Perc.
907	M.E.2 Toprtek1	Latin Perc.
908	M.E.2 Toprtek2	Latin Perc.
909	M.E.2 Toprtokat	Latin Perc.
910	M.E.2 Trill	Latin Perc.
911	M.E.2 Zil1	Ethnic Perc.
912	M.E.2 Zil2	Ethnic Perc.
913	M.E.2 Zil3	Ethnic Perc.
914	M.E.2 Zilgit	SFX
915	Orchestra Hit	SFX
916	Band Hit	SFX
917	Impact Hit	SFX
918	Metal Hit	SFX
919	Yeah!	SFX
920	Yeah! Solo	SFX
921	Uhh	SFX
922	Hit It	SFX
923	Uhhhh Solo	SFX
924	Comp Voice Noise	SFX
925	Stadium	SFX
926	Applause	SFX
927	Scream	SFX
928	Laughing	SFX
929	Footsteps1	SFX
930	Footsteps2	SFX
931	Bird1	SFX
932	Bird2	SFX
933	Dog	SFX
934	Gallop	SFX
935	Cricket	SFX
936	Cat	SFX
937	Growl	SFX
938	Heart Beat	SFX
939	Heart Beat GM	SFX
940	Punch	SFX
941	Tribe	SFX

#	Name	Family
942	Door Creak	SFX
943	Door Slam	SFX
944	Car Engine	SFX
945	Car Stop	SFX
946	Car Pass	SFX
947	Car Crash	SFX
948	Train	SFX
949	Helicopter	SFX
950	Gun Shot1	SFX
951	Gun Shot2	SFX
952	Machine Gun	SFX
953	Laser Gun	SFX
954	Explosion	SFX
955	Thunder	SFX
956	Wind	SFX
957	Stream	SFX
958	Bubble	SFX
959	Bubble GM	SFX
960	Church Bell	SFX
961	Telephone Ring	SFX
962	Xylophone Spectr	SFX
963	Cricket Spectrum	SFX
964	Air Vortex	SFX
965	Noise White	SFX
966	Noise FM Mod	SFX
967	Tubular	Ethnic Perc.
968	Gamelan	Ethnic Perc.
969	Tambura	Ethnic Perc.
970	Gtr Cut Noise1	SFX
971	Gtr Cut Noise2	SFX
972	Power Chord	SFX
973	Fret Noise	SFX
974	Dist. Slide1	SFX
975	Dist. Slide2	SFX
976	E.Gtr Pick1	SFX
977	E.Gtr Pick2	SFX
978	Gtr Scratch1	SFX
979	Gtr Scratch2	SFX
980	Ac.Bs-String Slap	SFX
981	Amp Noise	SFX
982	Space Lore	SFX
983	Swish Terra	SFX
984	Hand Drill	SFX
985	Mouth Harp	SFX
986	Grv BD1	Bass Drum
987	Grv BD2	Bass Drum
988	Grv BD3	Bass Drum
989	Grv BD4	Bass Drum
990	Grv BD5	Bass Drum
991	Grv BD6	Bass Drum
992	Grv BD7	Bass Drum
993	Grv BD8	Bass Drum
994	Grv SD1	Snare Drum

#	Name	Family
995	Grv SD2	Snare Drum
996	Grv SD3	Snare Drum
997	Grv SD4	Snare Drum
998	Grv SD5	Snare Drum
999	Grv SD6	Snare Drum
1000	Grv SD7	Snare Drum
1001	Grv SD8	Snare Drum
1002	Grv SD9	Snare Drum
1003	Grv Rim1	Snare Drum
1004	Grv Rim2	Snare Drum
1005	Grv Rim3	Snare Drum
1006	Grv HH Closed1	Hi Hat
1007	Grv HH Closed2	Hi Hat
1008	Grv HH Closed3	Hi Hat
1009	Grv HH Closed4	Hi Hat
1010	Grv Hi Tom1	Tom
1011	Grv Hi Tom2	Tom
1012	Grv Ride	Cymbal
1013	Grv Crash	Cymbal
1014	Grv Fx1	SFX
1015	Grv Fx2	SFX
1016	Grv Fx3	SFX
1017	Grv Fx4	SFX
1018	Grv Fx5	SFX
1019	Grv Fx6	SFX
1020	Grv Fx7	SFX
1021	Grv Fx8	SFX
1022	Grv Fx9	SFX
1023	Grv Fx10	SFX
1024	Grv Fx11	SFX
1025	Grv Fx12	SFX
1026	Grv Fx13	SFX
1027	Grv Slice1	SFX
1028	Grv Slice2	SFX
1029	Grv Slice3	SFX
1030	Grv Slice4	SFX
1031	Grv Slice5	SFX
1032	Grv Slice6	SFX
1033	Grv Slice7	SFX
1034	Grv Slice8	SFX
1035	Grv Slice9	SFX
1036	Grv Slice10	SFX
1037	66 BD	Bass Drum
1038	88 BD	Bass Drum
1039	88 SD1 GM	Snare Drum
1040	88 SD2	Snare Drum
1041	88 SD2 GM	Snare Drum
1042	88 Rim Shot GM	Snare Drum
1043	88 HH Close1 GM	Hi Hat
1044	88 HH Close2	Hi Hat
1045	88 HH Close2 GM	Hi Hat
1046	88 HH Open1	Hi Hat
1047	88 HH Open1 GM	Hi Hat

#	Name	Family
1048	88 HH Open2	Hi Hat
1049	88 Tom1	Tom
1050	88 Tom2	Tom
1051	88 Crash	Cymbal
1052	88 Crash GM	Cymbal
1053	88 Congas	Latin Perc.
1054	88 Claps	Latin Perc.
1055	88 Claves	Latin Perc.
1056	88 Cowbell	Ethnic Perc.
1057	88 Maracas	Ethnic Perc.
1058	99 SD	Snare Drum
1059	99 HH Close	Hi Hat
1060	99 HH Open	Hi Hat
1061	99 Ride Dance	Cymbal
1062	Click	SFX
1063	Click GM	SFX
1064	Seq Click	SFX
1065	Empty	(none)

Pads

You can assign the following Hits or Sequences to the four Pads. Older sounds might be still assigned to the Pads when loading musical resources generated with an older operating system (see the following section).

#	HIT - Drum	#	HIT - Percussion	#	HIT - World 1	#	Hit - World 2	#	HIT - Orchestral
1	88 Cowbell	1	Agogo 1	1	Baja 1	1	Kup 1	1	Brass Fall
2	88 Crash	2	Agogo 2	2	Baja 2	2	Kup 2	2	Orch.Cymbal 1
3	China	3	Castanet 1	3	China Gong	3	Kup 3	3	Orch.Cymbal 2
4	Crash 1	4	Castanet 2	4	Darbuka 1	4	Kup 4	4	Orch. Hit
5	Crash 2	5	Conga Hi	5	Darbuka 2	5	Ramazan 1	5	Orch. Snare
6	Rev. Cymbal	6	Conga Low	6	Darbuka 3	6	Ramazan 2	6	Orch. Sn. Roll
7	Ride 1	7	Conga Mute	7	Darbuka 4	7	Ramazan 3	7	Timpani 1
8	Ride 2	8	Conga Slap	8	Darbuka 5	8	Rek Dom Ak	8	Timpani 2
9	Ride Bell	9	Cowbell	9	Darbuka 6	9	Rik 1	9	Timpani 3
10	Splash	10	Cuica 1	10	Darbuka 7	10	Rik 2	10	Timpani 4
11	Sticks	11	Cuica 2	11	Darbuka 8	11	Rik 3	11	Orchestra Tutti
12	Rim-Shot	12	Jingle Bell	12	Davul	12	Sagat 1	12	
13	Hi Tom Flam	13	Long Guiro	13	Douf Rim Ak	13	Sagat 2	13	
14	Mid Tom Flam	14	Short Guiro	14	Dragon Gong	14	Tef 1	14	
15	Low Tom Flam	15	Open Bells	15	Hollo 1	15	Tef 2	15	
16	Tom Flam End	16	Rain Stick	16	Hollo 2	16	Tef 3	16	
17	Drum Single A	17	Tamb. Acc. 1	17		17	Tef 4	17	
18	Drum Single B	18	Tamb. Acc. 2	18		18	Tef 5	18	
19	Drum Single C	19	Tamb. Open	19		19	Tef 6	19	
20	Drum Single D	20	Tamb. Push	20		20		20	
21	Drum Sing.HouseA	21	Timbale Hi	21		21		21	
22	Drum Sing.HouseB	22	Timbale Low	22		22		22	
23	Drum Sing.HouseC	23	Timbale Rim 1	23		23		23	
24	Drum Sing.HouseD	24	Timbale Rim 2	24		24		24	
25	Drum Kit A	25	Triangle 1	25		25		25	
26	Drum Kit B	26	Triangle 2	26		26		26	
27	Drum Kit C	27	Vibra Slap	27		27		27	
28	Drum Kit D	28	Whistle 1	28		28		28	
29	Drum Kit E	29	Whistle 2	29		29		29	
30	Drum Kit F	30	Windchimes 1	30		30		30	
31		31	Windchimes 2	31		31		31	
32		32	Windchimes 3	32		32		32	

#	HIT - Synth&Pad	#	HIT - Voice	#	HIT - Blocks	#	HIT - Misc&SFX 1	#	HIT - Misc&SFX 2
1	Cosmic	1	Aah !	1	Blk Funk 1 A	1	Applause	1	Bubble
2	VCF Modulation	2	Hit it !	2	Blk Funk 1 B	2	Bird 1	2	Car Crash
3	Planet Lead	3	Laughing	3	Blk Funk 1 C	3	Bird 2	3	Car Engine
4	Brightness	4	Scream	4	Blk Funk 1 D	4	Cat	4	Car Pass
5	Crystal	5	Uuh !	5	Blk Funk 2 A	5	Church Bell	5	Car Stop
6	New Age Pad	6	Yeah ! 1	6	Blk Funk 2 B	6	Crickets	6	Explosion
7	Fifths Lead	7	Yeah ! 2	7	Blk Funk 2 C	7	Dist. Slide 1	7	Gun Shot
8	Calliope	8		8	Blk Funk 2 D	8	Dist. Slide 2	8	Helicopter
9	Caribbean	9		9	Blk Organ A	9	Dog	9	Jet Plane
10	Rezbo	10		10	Blk Organ B	10	Door Creak	10	Laser Gun
11	Digital Polsix	11		11	Blk Organ C	11	Door Slam	11	Machine Gun
12	Motion Raver	12		12	Blk Organ D	12	Foosteps 1	12	Phone Ring
13	Moving Bell	13		13	Blk Choir A	13	Foosteps 2	13	Punch
14	Elastick Pad	14		14	Blk Choir B	14	Heart Beat	14	River
15	Rave	15		15	Blk Choir C	15	Horse Gallop	15	Seashore
16	Dance Remix	16		16	Blk Choir D	16	Lion	16	Siren
17	Vintage Sweep	17		17		17	Scratch 1	17	Starship
18	You Decide	18		18		18	Scratch 2	18	Thunder
19		19		19		19	Scratch 3	19	Train
20		20		20		20	Scratch 4	20	Wind
21		21		21		21	Scratch 5	21	
22		22		22		22	Scratch 6	22	
23		23		23		23	Stadium	23	
24		24		24		24		24	
25		25		25		25		25	
26		26		26		26		26	
27		27		27		27		27	
28		28		28		28		28	
29		29		29		29		29	
30		30		30		30		30	
31		31		31		31		31	
32		32		32		32		32	
#	SEQ - Drum	#	SEQ - Percussion	#	SEQ - Groove	#	SEQ - Bass	#	SEQ - Piano
1	Drum DrumBasSolo	1	Perc FingerSnap	1	Grv Drum 1	1	Bass Pick Easy	1	Piano Accomp 1
2	Drum Snare Solo	2	Perc Triang.+HH	2	Grv Drum 2	2	Bass Pick Med.	2	Piano Accomp 2
3	Drum 8 Bt Easy	3	Perc Latin 1	3	Grv Brush	3	Bass Pick Busy	3	Piano Accomp 3
4	Drum 8 Bt Medium	4	Perc Latin 2	4	Grv Jazzy	4	Bass Finger Easy	4	Piano Accomp 4
5	Drum Rock 1	5	Perc Latin 3	5	Grv Latin	5	Bass Finger Med.	5	Piano Accomp 5
6	Drum Rock 2	6	Perc Mix	6	Grv HipHop 1	6	Bass Finger Walk	6	Piano Accomp 6
7	Drum Brush 1 3/4	7	Perc Soft	7	Grv HipHop 2	7	Bass Latin	7	Piano Accomp 7
8	Drum Brush 2 3/4	8	Perc Conga	8	Grv HipHop 3	8	Bass Slap	8	Piano Accomp 8
9	Drum Disco 1	9	Perc Conga+Ride	9	Grv HipHop 4	9	Bass Digital	9	Piano Accomp 9
10	Drum Disco 2	10	Perc Conga+Mix	10	Grv HipHop 5	10	Bass Synth	10	Piano Arpeg. 1
11	Drum Disco 3	11	Perc Conga+Bongo	11	Grv HipHop 6	11	Bass DigiFilter1	11	Piano Arpeg. 2
12	Drum Disco 4	12	Perc Conga+Tamb.	12	Grv Funk 1	12	Bass DigiFilter2	12	Piano Arp 1 3/4
13	Drum Funk 1	13	Perc Shaker	13	Grv Funk 2	13	Bass DigiFilter3	13	Piano Arp 2 3/4
14	Drum Funk 2	14	Perc Shak+Tamb 1	14	Grv Funk 3	14		14	Piano Arp Down
15	Drum Brush Shuff	15	Perc Shak+Tamb 2	15	Grv House 1	15		15	Piano Arp Up
16	Drum Latin	16	Perc Shak+Cong 1	16	Grv House 2	16		16	Piano Rhythm 1/8
17	Drum Progressiv1	17	Perc Shak+Cong 2	17	Grv Analog	17		17	Piano Rhythm1/8T
18	Drum Progressiv2	18	Perc Tambourine1	18	Grv Garage 1	18		18	Piano Latin Rock
19	Drum Fill 1	19	Perc Tambourine2	19	Grv Garage 2	19		19	Piano Salsa 1
20	Drum Fill 2	20	Perc Tamb+Conga1	20	Grv Dance 1	20		20	Piano Salsa 2
21	Drum Break	21	Perc Tamb+Conga2	21	Grv Dance 2	21		21	Pno GlissDwnWhit
22	Drum End	22	Perc Guiro+Bongo	22	Grv Techno 1	22		22	Pno GlissUpWhite
23		23	Perc Cowbel+Tamb	23	Grv Techno 2	23		23	Pno GlissDwnBlak
24		24	Perc 3/4	24		24		24	Pno GlissUpBlack
25		25	Perc 6/8	25		25		25	Honky End
26		26		26		26		26	

27		27		27		27		27	
28		28		28		28		28	
29		29		29		29		29	
30		30		30		30		30	
31		31		31		31		31	
32		32		32		32		32	
#	SEQ - Guitar	#	SEQ - Orchestral	#	SEQ - Solo	#	SEQ - Synth&Pad	#	SEQ - Misc&SFX
1	Gtr Steel Strum1	1	Timpani Roll 1	1	Solo Marimba	1	Synth Seq 1	1	Military 1
2	Gtr Steel Strum2	2	Timpani Roll 2	2	Solo Kalimba 1	2	Synth Seq 2	2	Military 2
3	Gtr Steel Strum3	3	Orch. Tutti 1	3	Solo Kalimba 2	3	Synth Seq 3	3	Military 3
4	Gtr Steel Strum4	4	Orch. Tutti 2	4	Solo Steel Drums	4	Synth Seq 4	4	Military 4
5	Gtr Steel Strum5	5	Orch. Tutti 3	5	Solo Vibes	5	Synth Seq 5	5	Horror 1
6	Gtr Steel Strum6	6	Orch. Tutti 4	6	Solo Gtr Dist.	6	Synth Seq 6	6	Horror 2
7	GtSteelStrum 3/4	7	Orch. Harp 1	7	Solo Slide Steel	7	Synth Seq 7	7	Horror 3
8	Gtr Steel Arp 1	8	Orch. Harp 2	8	Solo Banjo	8	Synth Seq 8	8	Horror 4
9	Gtr Steel Arp 2	9	Orch. Harp 3	9	Solo Violin	9	Synth Seq 9	9	Lullaby 1
10	Gtr Steel Arp 3	10	Orch. Harp 4	10	Solo Harpsi 3/4	10	Synth Seq 10	10	Lullaby 2
11	GtrSteel Arp 6/8	11	Orch. Harp 5	11	Solo Harpsi 4/4	11	Synth Seq 11	11	Nature - River
12	Gtr Steel Mute 1	12	French Horns 1	12	Solo Gtr Funk	12	Synth Portam. 1	12	Nature - Storm
13	Gtr Steel Mute 2	13	French Horns 2	13	Solo Piano 1	13	Synth Portam. 2	13	Metronome 3/4
14	Guitar Country	14	Strings 1	14	Solo Piano 2	14	Synth Portam. 3	14	PreCount 3/4
15	Gtr Nylon Strum1	15	Strings 2	15	Solo Piano 3	15	Synth Portam. 4	15	Metronome 4/4
16	Gtr Nylon Strum2	16	Strings 3	16	Solo Piano 4	16	Synth Filter 1	16	PreCount 4/4
17	Gtr Nylon Strum3	17	Strings 4	17	Solo Synth 1	17	Synth Filter 2	17	PreCount 4/4 Dbl
18	Gtr Nylon Strum4	18	Strings 5	18	Solo Synth 2	18	Synth Pad Panned	18	Toccatà
19	Gtr Nylon Strum5	19	Strings 6	19	Solo Synth 3	19	Synth Master Pad	19	5th Intro
20	Gtr Nylon Strum6	20	Strings 7	20	Solo Synth 4	20	Synth Dark Pad	20	Primavera
21	Gtr Nylon Arp 1	21		21	Solo Synth 5	21		21	Circus 1
22	Gtr Nylon Arp 2	22		22	Solo Synth 6	22		22	Circus 2
23	Gtr Nylon Arp 3	23		23	Solo Guitar 1	23		23	
24	GtrNylon Arp 3/4	24		24	Solo Guitar 2	24		24	
25		25		25	Solo Guitar 3	25		25	
26		26		26		26		26	
27		27		27		27		27	
28		28		28		28		28	
29		29		29		29		29	
30		30		30		30		30	
31		31		31		31		31	
32		32		32		32		32	

Effects

The following list shows all the Factory Effects. Detailed information on each effect's parameter are contained in the "Effects" chapter (see page 357).

For FX Master 1/2

0	No Effect	38	St. Env. Phaser	78	P4EQ - Exciter
1	Stereo Compressor	39	Stereo Vibrato	79	P4EQ - Wah
2	Stereo Limiter	40	St. Auto Fade Mod.	80	P4EQ - Cho/Flng
3	Multiband Limiter	41	2Voice Resonator	81	P4EQ - Phaser
4	St.MasteringLimtr	42	Doppler	82	P4EQ - Mt. Delay
5	Stereo Gate	43	Scratch	83	Comp - Wah
6	St.Parametric4EQ	44	Grain Shifter	84	Comp - Amp Sim
7	St. Graphic 7EQ	45	Stereo Tremolo	85	Comp - OD/HiGain
8	St.Exciter/Enhncr	46	St. Env. Tremolo	86	Comp - P4EQ
9	Stereo Isolator	47	Stereo Auto Pan	87	Comp - Cho/Flng
10	St. Wah/Auto Wah	48	St. Phaser + Trml	88	Comp - Phaser
11	St. Vintage Wah	49	St. Ring Modulator	89	Comp - Mt. Delay
12	St. Random Filter	50	Detune	90	Limiter - P4EQ
13	St. MultiModeFilter	51	Pitch Shifter	91	Limiter-Cho/Flng
14	St. Sub Oscillator	52	Pitch Shifter BPM	92	Limiter - Phaser
15	Talking Modulator	53	Pitch Shift Mod.	93	Limiter - Mt.Delay
16	Stereo Decimator	54	Organ Vib/Chorus	94	Exciter - Comp
17	St. Analog Record	55	Rotary Speaker	95	Exciter - Limiter
18	OD/Hi.Gain Wah	56	L/C/R Delay	96	Exciter-Cho/Flng
19	St. Guitar Cabinet	57	Stereo/CrossDelay	97	Exciter - Phaser
20	St. Bass Cabinet	58	St. Multitap Delay	98	Exciter - Mt.Delay
21	Bass Amp Model	59	St. Mod Delay	99	OD/HG - Amp Sim
22	Bass Amp+Cabinet	60	St. Dynamic Delay	100	OD/HG - Cho/Flng
23	Tube PreAmp Model	61	St. AutoPanningDly	101	OD/HG - Phaser
24	St. Tube PreAmp	62	Tape Echo	102	OD/HG - Mt.Delay
25	MicModel+PreAmp	63	Auto Reverse	103	Wah - Amp Sim
26	Stereo Chorus	64	Sequence BPM Dly	104	Decimator - Amp
27	Black Chorus/Flanger	65	L/C/R BPM Delay	105	Decimator - Comp
28	St.HarmonicChorus	66	Stereo BPM Delay	106	AmpSim - Tremolo
29	St. Biphase Mod.	67	St.BPM Mtap Delay	107	Cho/Flng - Mt.Dly
30	Multitap Cho/Delay	68	St.BPM Mod. Delay	108	Phaser - Cho/Flng
31	Ensemble	69	St.BPMAutoPanDly	109	Reverb - Gate
32	Polysix Ensemble	70	Tape Echo BPM		
33	Stereo Flanger	71	Reverb Hall		
34	St. Random Flanger	72	Reverb SmoothHall		
35	St. Env. Flanger	73	Reverb Wet Plate		
36	Stereo Phaser	74	Reverb Dry Plate		
37	St. Random Phaser	75	Reverb Room		
		76	ReverbBrightRoom		
		77	Early Reflections		

For FX Master 2 only

- 110 St.Mltband Limiter
- 111 PianoBody/Damper
- 112 OD/HyperGain Wah
- 113 GuitarAmp + P4EQ
- 114 BassTubeAmp+Cab.
- 115 St. Mic + PreAmp
- 116 Multitap Cho/Delay
- 117 St. Pitch Shifter
- 118 St. PitchShift BPM
- 119 Rotary SpeakerOD
- 120 L/C/R Long Delay
- 121 St/Cross Long Dly
- 122 Hold Delay
- 123 LCR BPM Long Dly
- 124 St. BPM Long Dly
- 125 Early Reflections

MIDI Preset

		Default	Master Kbd	Player	Acc ordion 1	Acc ordion 2	Acc ordion 3	Tablet
MIDI IN Channel	1	Ply Tr 1	Global	Ply Tr 1	Global	Upper 1	Upper 1	-
	2	Ply Tr 2	Control	Ply Tr 2	Lower	Lower	Lower	-
	3	Ply Tr 3	-	Ply Tr 3	Bass	-	Bass	-
	4	Ply Tr 4	-	Ply Tr 4	-	Upper 2	Upper 2	-
	5	Ply Tr 5	-	Ply Tr 5	-	Upper 3	Upper 3	-
	6	Ply Tr 6	-	Ply Tr 6	-	-	-	-
	7	Ply Tr 7	-	Ply Tr 7	-	-	-	-
	8	Ply Tr 8	-	Ply Tr 8	-	-	-	-
	9	Ply Tr 9	-	Ply Tr 9	-	Bass	-	-
	10	Ply Tr 10	-	Ply Tr 10	Drum	Drum	Drum	-
	11	Ply Tr 11	-	Ply Tr 11	Percussion	Percussion	Percussion	-
	12	Ply Tr 12	-	Ply Tr 12	Acc 1	Acc 1	Acc 1	-
	13	Ply Tr 13	-	Ply Tr 13	Acc 2	Acc 2	Acc 2	-
	14	Ply Tr 14	-	Ply Tr 14	Acc 3	Acc 3	Acc 3	-
	15	Ply Tr 15	-	Ply Tr 15	Acc 4	Acc 4	Acc 4	-
	16	Ply Tr 16	-	Ply Tr 16	Acc 5	Acc 5	Acc 5	Control
MIDI OUT Channel	1	Upper 1	Upper 1	Ply Tr 1	Upper 1	Ply Tr 1	Ply Tr 1	-
	2	Upper 2	Upper 2	Ply Tr 2	Upper 2	Ply Tr 2	Ply Tr 2	-
	3	Upper 3	Upper 3	Ply Tr 3	Upper 3	Ply Tr 3	Ply Tr 3	-
	4	Lower	Lower	Ply Tr 4	Lower	Ply Tr 4	Ply Tr 4	-
	5	-	-	Ply Tr 5	-	Ply Tr 5	Ply Tr 5	-
	6	-	-	Ply Tr 6	-	Ply Tr 6	Ply Tr 6	-
	7	-	-	Ply Tr 7	-	Ply Tr 7	Ply Tr 7	-
	8	-	-	Ply Tr 8	-	Ply Tr 8	Ply Tr 8	-
	9	-	-	Ply Tr 9	-	Ply Tr 9	Ply Tr 9	-
	10	-	-	Ply Tr 10	-	Ply Tr 10	Ply Tr 10	-
	11	-	-	Ply Tr 11	-	Ply Tr 11	Ply Tr 11	-
	12	-	-	Ply Tr 12	-	Ply Tr 12	Ply Tr 12	-
	13	-	-	Ply Tr 13	-	Ply Tr 13	Ply Tr 13	-
	14	-	-	Ply Tr 14	-	Ply Tr 14	Ply Tr 14	-
	15	-	-	Ply Tr 15	-	Ply Tr 15	Ply Tr 15	-
	16	-	-	Ply Tr 16	-	Ply Tr 16	Ply Tr 16	Control
Chord 1 Chann.		Off	1	Off	2	2	2	Off
Chord 2 Chann.		Off	Off	Off	3	3	Off	Off
MIDI IN Velocity		Normal	Normal	Normal	110	110	Normal	Normal
MIDI IN Oct. Trp.		On	On	On	On	On	On	On
MIDI IN Track Mute		-	On	-	-	-	-	On
Upper er Oct. Trp.		0	0	0	0	0	0	0
Lower Oct. Trp.		0	0	0	0	0	0	0

Assignable parameters

List of Pedal/Footswitch functions

The following functions can be assigned to an Assignable Footswitch or Pedal.

Function	Meaning	
Functions assignable to a Footswitch		
Off	No function assigned	
Style Start/Stop	Same functions of the control panel buttons with the same name	
Play Stop Player 1		
Play Stop Player 2		
Go to Beginning-Player 1		
Go to Beginning-Player 2		
Chord Seq. Record		
Chord Seq. Play		
Synchro Start		
Synchro Stop		
Tap Tempo/Reset		
Tempo Lock		
Ritardando		Progressively decreases the Tempo value
Accelerando		Progressively increases the Tempo value
Tempo Up		Increases the Tempo value
Tempo Down		Decreases the Tempo value
Intro 1		Same functions of the control panel buttons with the same name
Intro 2		
Intro 3/Count In		
Ending 1		
Ending 2		
Ending 3		
Fill 1		
Fill 2		
Fill 3		
Fill 4		
Auto Fill		
Break		
Variation 1		
Variation 2		
Variation 3		
Variation 4		
Variation Up	Selects the next Variation	
Variation Down	Selects the previous Variation	
Fade In/Out	Same functions of the control panel buttons with the same name	
Memory		
Bass Inversion		
Manual Bass		
Split		
Style Up		Selects the next Style
Style Down		Selects the previous Style

Function	Meaning
STS Mode	Same functions of the control panel buttons with the same name
STS1	
STS2	
STS3	
STS4	
STS Up	Selects the next STS
STS Down	Selects the previous STS
Perform. Up	Selects the next Performance
Perform. Down	Selects the previous Performance
Style Change	Style number
Transpose (b)	Same functions of the control panel buttons with the same name
Transpose (#)	
Upper Octave Up	
Upper Octave Down	
Punch In/Out	Turns Punch Recording on/off
Style-Upper1 Mute	
Style-Upper2 Mute	
Style-Upper3 Mute	
Style-Lower Mute	
Style-Drum Mute	
Style-Percussion Mute	
Style-Bass Mute	
Style-Acc1 Mute	
Style-Acc2 Mute	
Style-Acc3 Mute	
Style-Acc4 Mute	
Style-Acc5 Mute	
Style-Acc1-5 Mute	
Song-Melody Mute	Mute of the Standard MIDI File's track selected as the Melody track (Global:Mode Preference>Song & Seq.).
Vocal Remover	Voice removal from the MP3 file
Song-Drum&Bass Mode	Mute of all tracks, apart for track 2 (usually Bass) and 10 (usually Drum). It doesn't work on MP3 files.
Solo Selected Track	
Damper Pedal	
Soft Pedal	
Sostenuto Pedal	
Bass&Lower Backing	When the Style is not playing and you are in Split mode, you can play the Lower track with your left hand, while the Bass still plays the chord root. See "Bass & Lower Backing" on page 137 of the User's Manual.
Ensemble	
QuarterTone	Turns Quarter Tone on/off
Global-Scale	When the switch or footswitch is pressed, the Global > General Controls > Scale is recalled in the display.

Function	Meaning
SubScale Preset 1-SC1	Same functions of the SC Preset buttons in the display.
SubScale Preset 2-SC2	
SubScale Preset 3-SC3	
SubScale Preset 4-SC4	
Chord Latch	Holds the recognized chord until the pedal is released
Chord Latch + Damper	Holds the recognized chord until the pedal is released, and sustains the tracks where the Damper has been turned on
Glide	When the pedal is pressed, affected notes on Upper tracks are bent down, according to settings for the Pitch Bend on the same tracks. When the pedal is released, notes return to the normal pitch, at the speed defined by the "Time" parameter (see "Glide" on page 202 of the User's Manual).
Mic In Mute	
Mic Talk	Turns all Voice Processor effects down, to let you address the audience. See "Voice Processor Setup: Talk" on page 99.
Mic Lead On/Off	On/off switch controls assigned to the Voice Processor. Press to activate, press a second time to deactivate.
Mic Harmony On/Off	
Mic FX On/Off	
FX CC12 Switch	Standard FX controllers
FX CC13 Switch	
Rotary Spkr On/Off	
Rotary Spkr Fast/Slow	
Drawbar Perc On/Off	
Text Page Down	These options let you move to the previous or next page, when reading a text file loaded with a Song or Song Book entry (see "Text files loaded with Standard MIDI Files and MP3 files" on page 170 of the User's Manual).
Text Page Up	
SongBook Next	Moves to the next SongBook entry in the selected Custom List.
Pad 1	Same functions of the control panel buttons with the same name
Pad 2	
Pad 3	
Pad 4	
Pad Stop	
Sound Controller 1	To be used as triggers for two DNC parameter (transmit CC#80 or CC#81). When these functions are assigned to the selected physical controller, this latter becomes the corresponding Sound Controller (Sound Controller 1 or Sound Controller 2). You can then use this Sound Controller to control any of the DNC parameters.
Sound Controller 2	
Functions assignable to a Pedal	
Master Volume	
Accompaniment Volume	
Keyboard Expression	
Pad Volume	With this function assigned, you can control the proportional volume of all four Pads at the same time. Please note that the status of the Pad's volume, after having been modified with a pedal or slider, is made current, and will be saved in a Performance or STS by using the relevant Write procedure.

Function	Meaning
MP3 Volume	
Joystick +X	Joystick right
Joystick -X	Joystick left
Joystick +Y	Joystick forward
Joystick -Y	Joystick backward
Upper VDF Cutoff	Filter cutoff (for Sounds assigned to the Upper tracks)
Upper VDF Resonance	Filter resonance (for Sounds assigned to the Upper tracks)
Mic In Volume	
Mic Lead Voice Level	Continuous controls assigned to the Voice Processor.
Mic Harmony Level	
Mic Lead to Delay	
Mic Harmony to Delay	
Mic Reverb Level	
Mic FX Level	
FX CC12 Ctl	Standard FX controllers
FX CC13 Ctl	

List of Assignable Knob functions

The following functions can be assigned to the Assignable Knob.

Function	Meaning
Off	No function assigned
Keyboard Expression	
Pad Volume	
MP3 Volume	
Joystick +X	
Joystick -X	
Joystick +Y	
Joystick -Y	
Upper VDF Cutoff	
Upper VDF Resonance	
Mic Lead Voice Level	Continuous controls assigned to the Voice Processor
Mic Harmony Level	
Mic Lead to Delay	
Mic Harmony to Delay	
FX CC12 Ctl	
FX CC13 Ctl	

List of Assignable Switches functions

The following functions can be assigned to the Assignable Switches.

Function	Meaning
Off	No function assigned
Ritardando	Progressively increases the Tempo value
Accelerando	Progressively decreases the Tempo value
Style Up	Selects the next Style
Style Down	Selects the previous Style
Perform. Up	Selects the next Performance
Perform. Down	Selects the previous Performance
Style-Upper1 Mute	
Style-Upper2 Mute	
Style-Upper3 Mute	
Style-Lower Mute	
Style-Drum Mute	
Style-Percussion Mute	
Style-Bass Mute	
Style-Acc1 Mute	
Style-Acc2 Mute	
Style-Acc3 Mute	
Style-Acc4 Mute	
Style-Acc5 Mute	
Style-Acc 1-5 Mute	
Song-Melody Mute	Mute the Standard MIDI File's track selected as the Melody track (Global > Mode Preferences > Song & Seq.)
Vocal Remover	Voice removal from MP3 Songs
Song-Drum&Bass Mode	Mute of all tracks, apart for track 2 (usually Bass) and 10 (usually Drum)
Solo Selected Track	
Bass&Lower Backing	Mutes all tracks, except for Bass and Lower
QuarterTone	Turns Quarter Tone on/off
Global-Scale	Scale selection
SubScale Preset1-SC1	
SubScale Preset2-SC2	
SubScale Preset3-SC3	
SubScale Preset4-SC4	
Mic Talk	Turns all Voice Processor effects down, to let you address the audience. See "Talk" on page 269.
Mic Lead On/Off	On/Off controls assigned to the Voice Processor. Press to activate, press a second time to deactivate.
Mic FX On/Off	
FX CC12 Switch	Standard FX controllers
FX CC13 Switch	
Rotary Spkr On/Off	
Rotary Spkr Fast/Slow	
Text Page Down	These options let you move to the previous or next page, when reading a text file loaded with a Song (see "Text files loaded with Standard MIDI Files and MP3 files" on page 305) or Song Book entry (see "On-the-fly TXT loading" on page 305).
Text Page Up	

Function	Meaning
SongBook Next	Moves to the next SongBook Entry in the selected Custom List.
Sound Controller 1	Controls assigned to selected Sounds parameters
Sound Controller 2	

Scales

The following is a list of scales (or tunings) you can select in various operating modes.

- Equal** Equal tuning, the standard scale for modern Western music. It is made of 12 identical semi-tones.
- Pure Major** Major chords in the selected key are perfectly tuned.
- Pure Minor** Minor chords in the selected key are perfected tuned.
- Arabic** An arabic scale, using quarters of tone. Set the Key parameter as follow:
 - C - for the "rast C/bayati D" scale
 - D - for the "rast D/bayati E" scale
 - F - for the "rast F/bayati G" scale
 - G - for the "rast G/bayati A" scale
 - A# - for the "rast Bb/bayati C" scale
- Pythagorean** Pythagorean scale, based on the music theories of the great Greek philosopher and mathematician. It is most suitable for melodies.
- Werckmeister** Late Baroque/Classic Age scale. Very suitable for XVIII Century music.
- Kirnberger** Harpsichord scale, very common during the XVIII Century.
- Slendro** Scale of the Indonesian Gamelan. The octave is divided in 5 notes (C, D, F, G, A). The remaining notes are tuned as in the Equal tuning.
- Pelog** Scale of the Indonesian Gamelan. The octave is divided in 7 notes (all white keys, when Key is = C). The black keys are tuned as in the Equal tuning.
- Stretch** Simulates the "stretched" tuning of an acoustic piano. Basically an equal tuning, the lowest notes are slightly lower, while the highest notes are slightly higher than the standard.
- User** User scale, i.e. scale programmed by the user for the Style Play, Backing Sequence and Song Play modes. The user scale can be saved to a Performance, Style Settings, STS or Song. You can't select a User scale in Global mode.

Effects

Pa900 is equipped with four powerful Effect Processors for the internal MIDI tracks (Upper, Lower, Style, Song, Pads).

Dynamic Modulation sources

When the **D^{mod}** symbol is encountered, a Dynamic Modulation can be applied to the corresponding parameter. Dynamic Modulation allows for realtime control of the effect. The following table shows the available modulation sources.

Modulation source	Note
Off	No modulation
Gate1	
Gate1+Dmpr	
Gate2	
Gate2+Dmpr	
Note Nr	Note Number
Velocity	Note Velocity
Expo Velocity	Exponential Note Velocity
AfterTouch	After Touch
JS X	Joystick Left/Right
JS+Y: CC#01	Joystick Forward
JS-Y: CC#02	Joystick Backward
MIDI(CC#04)	
MIDI(CC#12)	
MIDI(CC#13)	
Ribb.(CC#16)	Ribbon Controller
MIDI(CC#18)	
MIDI(CC#17)	
MIDI(CC#19)	
MIDI(CC#20)	
MIDI(CC#21)	
MIDI(CC#17+)	
MIDI(CC#19+)	
MIDI(CC#20+)	
MIDI(CC#21+)	

Modulation source	Note
Damper: #64	
Prta.SW: #65	Portamento Switch
Sostenu: #66	Sostenuto Pedal
MIDI(CC#67)	
MIDI(CC#80)	
MIDI(CC#81)	
MIDI(CC#82)	
MIDI(CC#83)	
MIDI(CC#85)	
MIDI(CC#86)	
MIDI(CC#87)	
MIDI(CC#88)	
Tempo	

Some notes on the Gate parameters follow.

Gate1, Gate1+Dmpr (Gate1+Damper)

The effect is at maximum during note-on, and will stop when all keys are released. With **Gate1 + Dmpr**, the effect will remain at maximum even after the keys are released, as long as the damper (sustain) pedal is pressed.

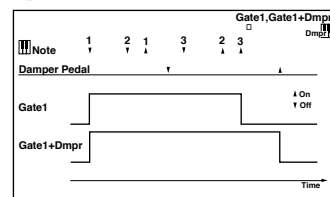

Gate2, Gate2+Dmpr (Gate2+Damper)

This is essentially the same as for Gate 1 or Gate 1 + Dmpr. However when **Gate 2** or **Gate 2 + Dmpr** are used as a dynamic modulation source for the EG, a trigger will occur at each note-on. (In the case of Gate 1 and Gate 1 + Dmpr, the trigger occurs only for the first note-on.)

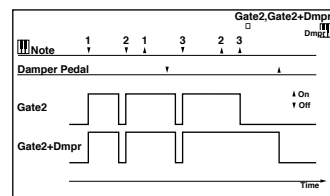

Dynamics (Dynamic)

0: No Effect

Select this option when you do not use any effects.

1: Stereo Compressor

This effect compresses the input signal to regulate the level and give a “punchy” effect. It is useful for guitar, piano, and drum sounds. This is a stereo compressor. You can link left and right channels, or use each channel separately.

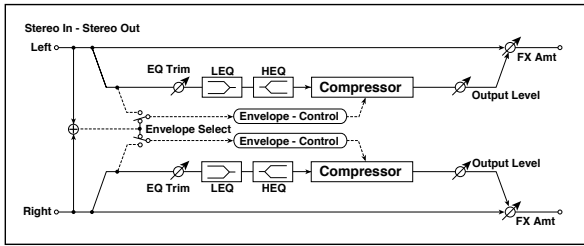

a	Envelope Select	L/R Mix, L/R Individually	Determines whether the left and right channels are linked or used separately
b	Sensitivity	1...100	Sets the sensitivity
c	Attack	1...100	Sets the attack level
d	EQ Trim	0...100	Sets the EQ input level
e	Pre LEQ Fc	Low, Mid-Low	Selects the cutoff frequency (low or mid-low) of the low-range equalizer
	Pre HEQ Fc	High, Mid-High	Selects the cutoff frequency (high or mid-high) of the high-range equalizer
f	Pre LEQ Gain [dB]	-15.0...+15.0	Sets the gain of the Low EQ
	Pre HEQ Gain [dB]	-15.0...+15.0	Sets the gain of the High EQ
g	Output Level	0...100	Sets the output level of the compressor
	Src	Off...Tempo	Selects the modulation source for the compressor output level
	Amt	-100...+100	Sets the modulation amount for the compressor output level
h	Wet/Dry	Dry, 1:99...99:1, Wet	Sets the Balance between the wet and dry signal
	Src	Off...Tempo	Selects a modulation source for Wet/Dry
	Amt	-100...+100	Sets the modulation amount for Wet/Dry

a: Envelope Select

This parameter selects whether the left and right channels are linked to control both signals simultaneously, or whether each channel is controlled independently.

b: Sensitivity

g: Output Level

The “Sensitivity” parameter sets the sensitivity of the compressor. If this parameter is set to a higher value, lower level sounds will be boosted. With a higher Sensitivity, the overall volume level is higher. To adjust the final volume level, use the “Output Level” parameter.

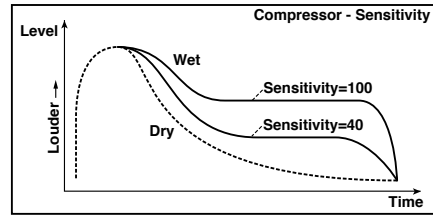

c: Attack

This parameter controls the attack level.

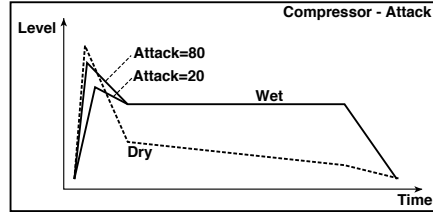

2: Stereo Limiter

The Limiter regulates the input signal level. It is similar to the Compressor, except that the Limiter compresses only signals that exceed the specified level to lower unnecessary peak signals. The Limiter applies a peaking-type EQ to the trigger signal (which controls the degree of the Limiter effect), allowing you to set any band width to be covered. This effect is a stereo limiter. You can link left and right channels, or use each channel individually.

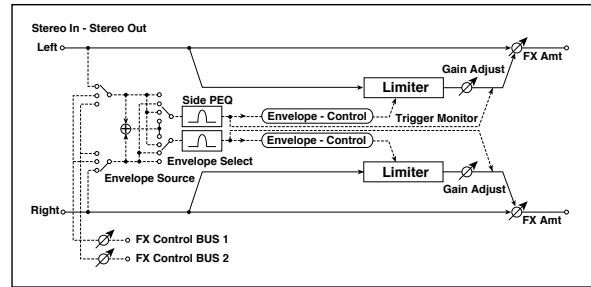

a	Envelope Select	L/R Mix, L Only, R Only, L/R Individually	Selects from linking both channels, controlling only from left channel, only from the right channel, or controlling each channel individually
b	Ratio	1.0 : 1 ... 50.0 : 1, Inf : 1	Sets the signal compression ratio
c	Threshold [dB]	-40...0	Sets the level above which the compressor is applied
v	Attack	1...100	Sets the attack time
	Release	1...100	Sets the release time
e	Gain Adjust [dB]	-Inf, -38...+24	Sets the output gain
	Src	Off...Tempo	Selects the modulation source for the output gain
f	Amt	-63...+63	Sets the modulation amount of the output gain
	Side PEQ Insert	Off, On	Toggles between on/off of the trigger signal's EQ
g	Trigger Monitor	Off, On	Switches between effect output monitor and trigger signal monitor
	Side PEQ Cutoff [Hz]	20...12.00k	Sets the EQ center frequency for the trigger signal
h	Q	0.5...10.0	Sets the EQ bandwidth for the trigger signal
	Gain [dB]	-18.0...+18.0	Sets the EQ gain for the trigger signal
h	Wet/Dry	Dry, 1:99...99:1, Wet	Balance between the wet and dry signal
	Src	Off...Tempo	Table , “Dynamic Modulation sources,” on page 357
	Amt	-100...+100	Amount of modulation source

a: Envelope Select

When L/R Mix is selected for this parameter, the left and right channels are linked to control the Limiter using the mixed signal. If L Only (or R Only) is selected, the left and right channels are linked, and the Limiter is controlled via only the left (or right) channel.

With L/R individually, the left and right channels control the Limiter individually.

b: Ratio

c: Threshold [dB]

e: Gain Adjust [dB]

This parameter sets the signal compression “Ratio”. Compression is applied only when the signal level exceeds the “Threshold” value.

Adjust the output level using the “Gain Adjust” parameter, since compression causes the entire level to be reduced.

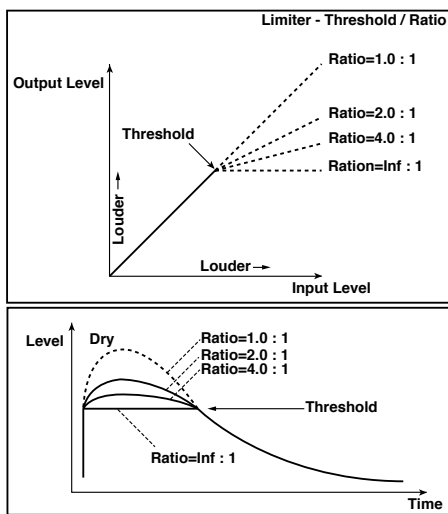

d: Attack

d: Release

These parameters set the attack time and release time. A higher attack time will cause the compression to be applied more slowly.

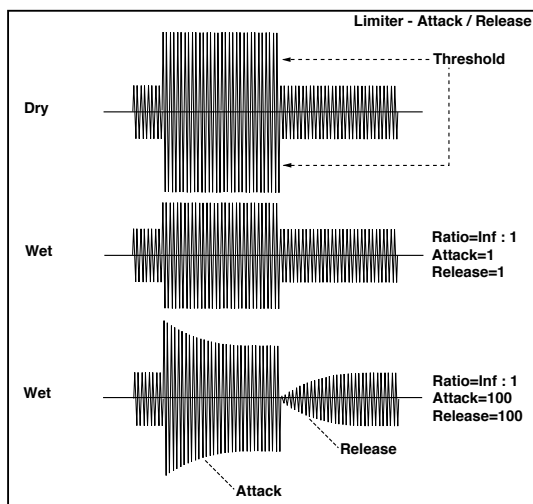

f: Trigger Monitor

Setting this parameter On will cause the trigger signal to be output, instead of the effect sound. Use this parameter to check the trigger signal with EQ applied.

Usually, set this to Off.

f: Side PEQ Insert

g: Side PEQ Cutoff [Hz]

g: Q

g: Gain [dB]

These parameters are used to set the EQ applied to the trigger signal.

The Limiter determines whether the compression is applied or not, based on the post-EQ trigger signal. Setting the equalizer allows you to set the Limiter to respond to any frequency band.

3: Multiband Limiter

This effect applies the Limiter to the low range, mid range, and high range of the input signal. You can control dynamics for each range to adjust the sound pressure of the low range, mid range, and high range in a different way from the EQ.

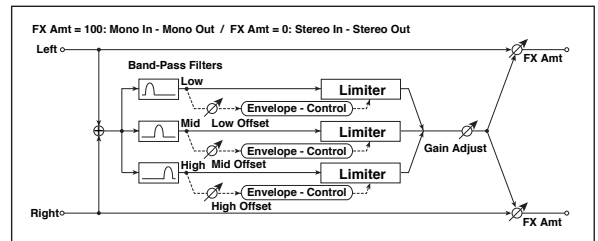

a	Ratio	1.0 : 1...50.0 : 1, Inf : 1	Sets the signal compression ratio
b	Threshold [dB]	-40...0	Sets the level above which the compressor is applied
c	Attack	1...100	Sets the attack time
d	Release	1...100	Sets the release time
e	Low Offset [dB]	-40...0	Gain of the low-range trigger signal
f	Mid Offset [dB]	-40...0	Gain of the mid-range trigger signal
g	High Offset [dB]	-40...0	Gain of the high-range trigger signal
h	Gain Adjust [dB]	-Inf, -38...+24	Sets the output gain
	Src	Off...Tempo	Selects the modulation source for the output gain
	Amt	-63...+63	Sets the modulation amount of the output gain
i	Wet/Dry	Dry, 1:99...99:1, Wet	Balance between the wet and dry signal
	Src	Off...Tempo	Table, “Dynamic Modulation sources,” on page 357
	Amt	-100...+100	Amount of modulation source

e: Low Offset [dB]

f: Mid Offset [dB]

g: High Offset [dB]

These parameters set the gain of the trigger signal.

For example, if you do not want to apply compression to the high range, reduce the “High Offset” value down below the “Threshold” level. In this way, the high range limiter will not respond, and compression will not be applied.

4: St.MasteringLimtr (Stereo Mastering Limiter)

This is a stereo limiter that is optimized for mastering songs.

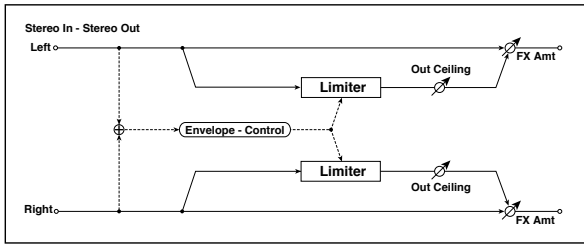

a	Threshold [dB]	-30.0...0.0	Sets the level above which the compressor is applied	
b	Out Ceiling [dB]	-30.0...0.0	Sets the output gain	
c	Release [msec]	0.50...1000.0	Sets the release time	
d	Wet/Dry	Dry, 1:99...99:1, Wet	Balance between the wet and dry signal	
	Src	Off...Tempo	Table, "Dynamic Modulation sources," on page 357	
	Amt	-100...+100	Amount of modulation source	

5: Stereo Gate

This effect mutes the input signal when it falls below a specified level. You can also invert the on/off status of the gate, or use note-on/off messages to turn the gate on/off directly.

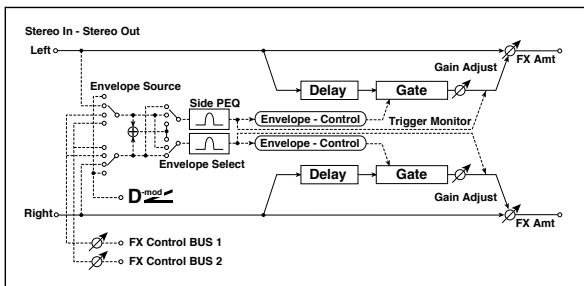

a	Envelope Source	D-mod, Input	Selects the source to control the gate: D-mod control, or use the input signal as a trigger	
b	Envelope Select	L/R Mix, L Only, R Only	Selects the control signal: left and right linked, left only, or right only	
	Src	Off...Tempo	Selects the source that will control the gate when Envelope Src = D-mod	
c	Threshold	0...100	Sets the level at which gating is applied	
	Polarity	+, -	Switches the polarity of gating	
d	Attack	1...100	Sets the attack time	
	Release	1...100	Sets the release time	
e	Delay Time [msec]	0...100	Sets the delay time for the gate input	
f	Side PEQ Insert	Off, On	Switches the trigger signal equalizer on/off	
	Trigger Monitor	Off, On	Switches between monitoring the effect output and the trigger signal	
g	Side PEQ Cutoff [Hz]	20...12.00k	Sets the center frequency of the equalizer for the trigger signal	
	Q	0.5...10.0	Sets the bandwidth of the equalizer for the trigger signal	
	Gain [dB]	-18.0...+18.0	Sets the gain of the equalizer for the trigger signal	
h	Wet/Dry	Dry, 1:99...99:1, Wet	Balance between the wet and dry signal	
	Src	Off...Tempo	Table, "Dynamic Modulation sources," on page 357	
	Amt	-100...+100	Amount of modulation source	

c: Threshold
d: Attack
d: Release

"Threshold" specifies the level at which gating occurs when "Envelope Select" is set to L/R Mix, L Only, or R Only.

"Attack" and "Release" specify the attack time and release time of the gate.

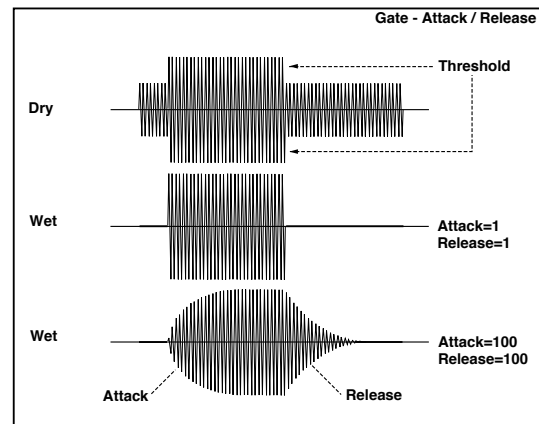
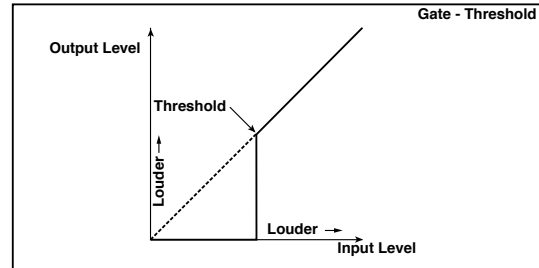

c: Polarity

This inverts the polarity of the gate on/off operation. With the "-" setting, the gate will close when the input signal exceeds the specified level. The direction in which the modulation source opens or closes the gate will also be reversed.

e: Delay Time [msec]

This sets the delay time for the input to the gate. When using shorter Attack Time settings, you can lengthen the Delay Time so that the sound is input after the gate opens.

EQ and Filters (EQ/Filter)

6: St.Parametric4EQ (Stereo Parametric 4-Band EQ)

This is a stereo 4-band parametric equalizer. You can select peaking type or shelving type for Band 1 and 4. The gain of Band 2 can be controlled by dynamic modulation.

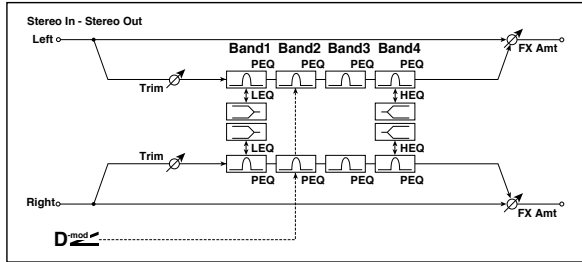

a	Trim	0...100	Sets the input level
b	Band1 Type	Peaking, Shelving-Low	Selects the type of Band 1
c	Band4 Type	Peaking, Shelving-High	Selects the type of Band 4
d	Band2 Dynamic Gain Src	Off...Tempo	Selects the modulation source of the Band 2 gain
	Amt [dB]	-18.0...+18.0	Sets the modulation amount of Band 2 gain
e	Band1 Cutoff [Hz]	20...1.00k	Sets the center frequency of Band 1
	Q	0.5...10.0	Sets the bandwidth of Band 1
	Gain [dB]	-18.0...+18.0	Sets the gain of Band 1
f	Band2 Cutoff [Hz]	50...10.00k	Sets the center frequency of Band 2
	Q	0.5...10.0	Sets the bandwidth of Band 2
	Gain [dB]	-18.0...+18.0	Sets the gain of Band 2
g	Band3 Cutoff [Hz]	300...10.00k	Sets the center frequency of Band 3
	Q	0.5...10.0	Sets the bandwidth of Band 3
	Gain [dB]	-18.0...+18.0	Sets the gain of Band 3
h	Band4 Cutoff [Hz]	500...20.00k	Sets the center frequency of Band 4
	Q	0.5...10.0	Sets the bandwidth of Band 4
	Gain [dB]	-18.0...+18.0	Sets the gain of Band 4
i	Wet/Dry	Dry, 1:99...99:1, Wet	Balance between the wet and dry signal
	Src	Off...Tempo	Table, "Dynamic Modulation sources," on page 357
	Amt	-100...+100	Amount of modulation source

b: Band1 Type
c: Band4 Type

Selects a filter type for Band 1 and 4.

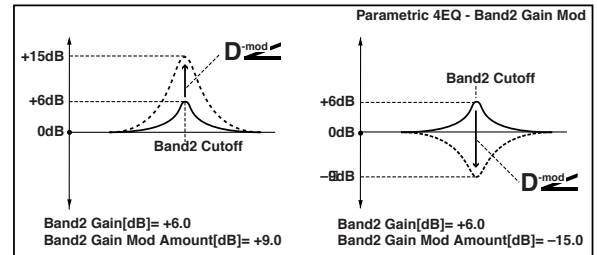
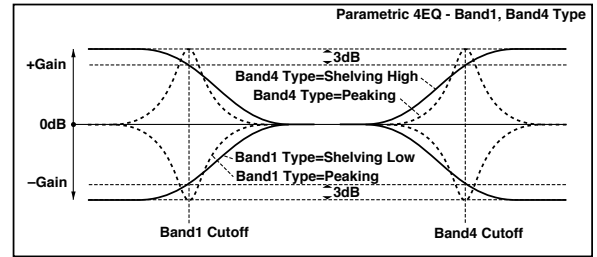

e, f, g, h: Q

These parameters set the bandwidth of each equalizer. The higher the value, the narrower the band becomes.

d: Band2 Dynamic Gain Src

d: Amt [dB]

You can control the gain of Band 2 using the modulation source.

7: St. Graphic 7EQ (Stereo Graphic 7-Band EQ)

This is a stereo 7-band graphic equalizer. The bar graph of the gain setting for each band gives you a clear, visual idea of frequency responses. You can select a center frequency setting for each band from twelve types, according to the sound.

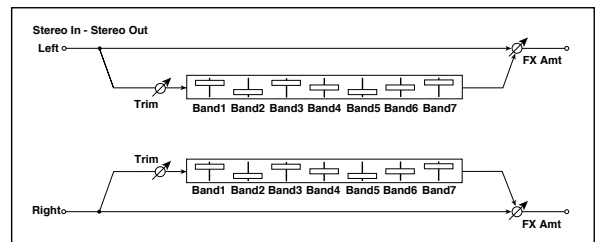

a	Type	1:Wide 1, 2:Wide 2, 3:Wide 3, 4:Half Wide 1, 5:Half Wide 2, 6:Half Wide 3, 7:Low, 8:Wide Low, 9:Mid, 10:Wide Mid, 11:High, 12:Wide High	Selects a combination of center frequencies for each band
b	Trim	0...100	Sets the input level
c	Band1 [dB]	-18.0...+18.0	Sets the gain of Band 1
d	Band2 [dB]	-18.0...+18.0	Sets the gain of Band 2
e	Band3 [dB]	-18.0...+18.0	Sets the gain of Band 3
f	Band4 [dB]	-18.0...+18.0	Sets the gain of Band 4
g	Band5 [dB]	-18.0...+18.0	Sets the gain of Band 5
h	Band6 [dB]	-18.0...+18.0	Sets the gain of Band 6
i	Band7 [dB]	-18.0...+18.0	Sets the gain of Band 7

j	Wet/Dry	Dry, 1:99...99:1, Wet	Balance between the wet and dry signal
	Src	Off...Tempo	Table, "Dynamic Modulation sources," on page 357
	Amt	-100...+100	Amount of modulation source

a: Type

This parameter selects a combination of center frequencies for each band. The center frequency of each band is shown in the right of the screen.

You can configure a 21-Band Graphic EQ ranging from 80 Hz to 18 kHz if you route three Graphic 7-Band EQ effects in series, with a setting of 7:Low, 9:Mid, and 11:High for each EQ.

8: St.Exciter/Enhncr (Stereo Exciter/Enhancer)

This effect is a combination of the Exciter, which adds a punch to the sound and the Enhancer, which adds spread and presence.

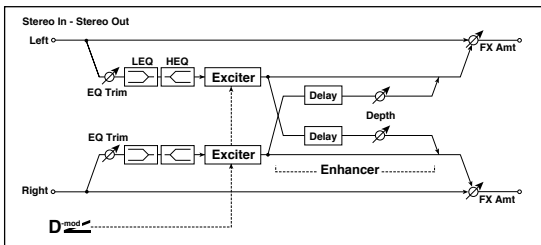

a	Exciter Blend	-100...+100	Sets the intensity (depth) of the Exciter effect
	Src	Off...Tempo	Selects the modulation source of the Exciter intensity
	Amt	-100...+100	Sets the modulation amount of the Exciter intensity
b	Emphasis Freq	0...70	Sets the frequency to be emphasized
	Src	Off...Tempo	Selects the modulation source of the frequency to be emphasized
	Amt	-70...+70	Sets the amount of modulation of the frequency to be emphasized
c	Enhancer Delay L [msec]	0.0...50.0	Sets the delay time for the Enhancer left channel
d	Enhancer Delay R [msec]	0.0...50.0	Sets the delay time for the Enhancer right channel
e	Enhancer Depth	0...100	Sets the determines to what degree the Enhancer effect is applied
	Src	Off...Tempo	Selects the modulation source of the Enhancer width
	Amt	-100...+100	Sets the modulation amount of the Enhancer width
f	EQ Trim	0...100	Sets the 2-band EQ input level
g	Pre LEQ Fc	Low, Mid-Low	Selects the cutoff frequency (low or mid-low) of the low-range equalizer
	Pre HEQ Fc	High, Mid-High	Selects the cutoff frequency (high or mid-high) of the high-range equalizer
h	Pre LEQ Gain [dB]	-15.0...+15.0	Gain of the Lo EQ
	Pre HEQ Gain [dB]	-15.0...+15.0	Gain of the High EQ
i	Wet/Dry	Dry, 1:99...99:1, Wet	Balance between the wet and dry signal
	Src	Off...Tempo	Table, "Dynamic Modulation sources," on page 357
	Amt	-100...+100	Amount of modulation source

a: Exciter Blend

This parameter sets the depth (intensity) of the Exciter effect. Positive values give a frequency pattern (to be emphasized) different from negative values.

b: Emphasis Freq

This parameter sets the frequency to be emphasized. Higher values will emphasize lower frequencies.

c: Enhancer Delay L [msec]

d: Enhancer Delay R [msec]

These parameters set the delay time for the Enhancer left and right channel. Specifying a slightly different delay time for the left and right channel will add a stereo image, depth, and width to the sound.

9: Stereo Isolator

This is a stereo effect that separates the input signal into low, mid, and high-frequency bands, and controls the volume of each band independently. For example you can separately boost or cut the kick, snare, and hi-hat sounds from a drum signal in real-time.

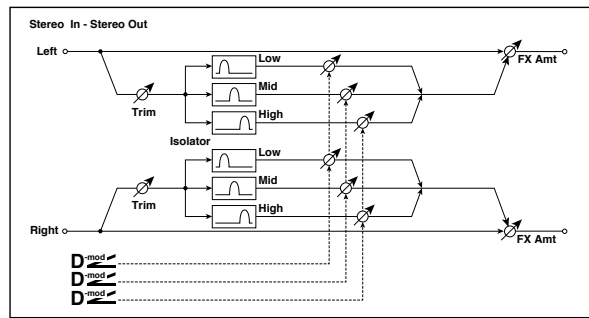

a	Trim	0...100	Sets the input level
b	Low/Mid [Hz]	100...500	Sets the frequency at which the low and mid bands are divided
c	Mid/High [Hz]	2000...6000	Sets the frequency at which the mid and high bands are divided
d	Low Gain [dB]	-Inf, -59...+12	Sets the low-frequency gain
	Src	Off...Tempo	Selects the source that will modulate low-frequency gain
	Amt	-72...+72	Sets the amount by which the low-frequency gain will be modulated
e	Mid Gain [dB]	-Inf, -59...+12	Sets the mid-frequency gain
	Src	Off...Tempo	Selects the modulation source for mid-frequency gain
	Amt	-72...+72	Sets the amount by which the mid-frequency gain will be modulated
f	High Gain [dB]	-Inf, -59...+12	Sets the high-frequency gain
	Src	Off...Tempo	Selects the modulation source for high-frequency gain
	Amt	-72...+72	Sets the amount by which the high-frequency gain will be modulated
g	Wet/Dry	Dry, 1:99...99:1, Wet	Balance between the wet and dry signal
	Src	Off...Tempo	Table, "Dynamic Modulation sources," on page 357
	Amt	-100...+100	Amount of modulation source

10: St. Wah/Auto Wah (Stereo Wah/Auto Wah)

This stereo wah effect allows you to create sounds from vintage wah pedal simulation to auto-wah simulation, and much broader range settings.

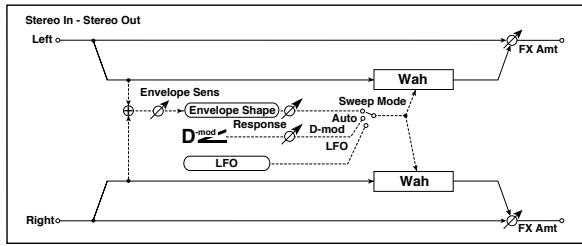

a	Frequency Bottom	0...100	Sets the lower limit of the wah center frequency	
	Frequency Top	0...100	Sets the upper limit of the wah center frequency	
b	Sweep Mode	Auto, D-mod, LFO	Selects the control from auto-wah, modulation source, and LFO	
	Src	Off...Tempo	Selects the modulation source for the wah when Sweep Mode=D-mod	
	Respon	0...100	Sets the response speed when Sweep Mode = Auto or D-mod	
c	Envelope Sens	0...100	Sets the sensitivity of auto-wah	
	Envelope Shape	-100...+100	Sets the sweep curve of auto-wah	
d	LFO Frequency [Hz]	0.02...20.00	Sets the speed of the LFO	
	Src	Off...Tempo	Selects a modulation source for LFO speed	
	Amt	-20.00...+20.00	Sets the modulation amount of LFO speed	
e	MIDI Sync	Off, On	When this is on, the LFO speed is set by BPM, Base Note, and Times, instead of Frequency	
	BPM	MIDI, 40.00...300.00	MIDI syncs to the system tempo; 40-300 sets the tempo manually for this individual effect	
	Base Note	r...w	Selects the type of notes that specify the LFO speed	
	Times	x1...x32	Sets the number of notes that specify the LFO speed	
f	Resonance	0...100	Sets the resonance amount	
	Low Pass Filter	Off, On	Switches the wah low pass filter on and off	
g	Output Level	0...100	Sets the output level of the effect sound	
	Src	Off...Tempo	Selects the modulation source that will control the effect output level	
	Amt	-100...+100	Sets the modulation amount of the effect output level	
h	Wet/Dry	Dry, 1:99...99:1, Wet	Balance between the wet and dry signal	
	Src	Off...Tempo	Table, "Dynamic Modulation sources," on page 357	
	Amt	-100...+100	Amount of modulation source	

a: Frequency Bottom

a: Frequency Top

The sweep width and direction of the wah filter are determined by the "Frequency Top" and "Frequency Bottom" settings.

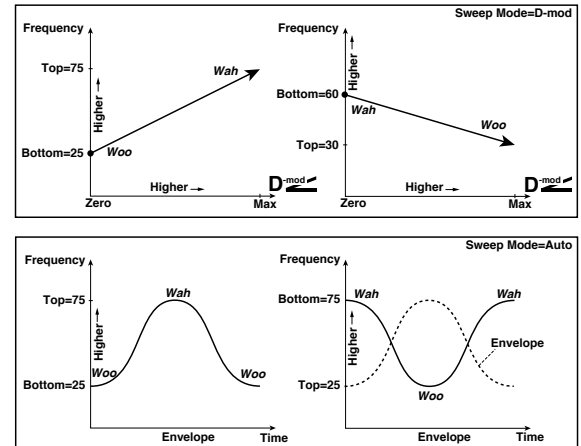

b: Sweep Mode

This parameter changes the wah control mode. Setting "Sweep Mode" to Auto will select an auto-wah that sweeps according to envelope changes in the input signal level. Auto-wah is frequently used for funk guitar parts and clav sounds.

When "Sweep Mode" is set to D-mod, you can control the filter directly via the modulation source in the same way as a wah pedal.

When "Sweep Mode" is set to LFO, the effect uses LFO to sweep in cycle.

c: Envelope Sens

This parameter sets the sensitivity of auto-wah. Increase the value if the input signal is too low to sweep. Reduce the value if the input signal is so high that the filter is stopped temporarily.

c: Envelope Shape

This parameter determines the sweep curve for auto-wah.

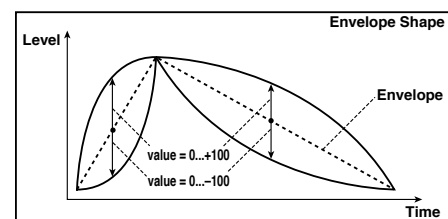

d: LFO Frequency [Hz]

e: MIDI Sync

When "MIDI/Tempo Sync"=Off, the LFO speed uses the LFO Frequency parameter setting. When "MIDI/Tempo Sync"=On, the LFO speed follows the "BPM", "Base Note", and "Times" settings.

e: BPM

e: Base Note

e: Times

One cycle of LFO sweep is obtained by multiplying the length of a note (r...w) (selected for "Base Note", in relation to the tempo specified in "BPM", or the MIDI Clock tempo if "BPM" is set to MIDI) by the number specified in the Times parameter.

11: St. Vintage Wah (Stereo Vintage/Custom Wah)

This effect simulates the tonal character of a vintage wah pedal. You can customize the tone and range settings.

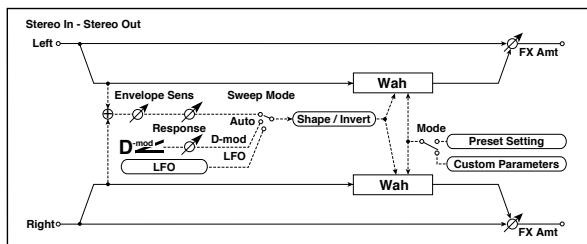

a	Mode	Preset, Custom	Selects either preset or custom settings	
	Shape	-100...+100	Sets the curve of the sweep	
	Invert	Off, On	Inverts the polarity of the sweep	
b	Frequency Bottom	0...100	Sets the lower limit of the wah center frequency when Mode = Custom	
	Frequency Top	0...100	Sets the upper limit of the wah center frequency when Mode = Custom	
c	Resonance Bottom	0...100	Sets the lower limit of resonance amount when Mode=Custom	
	Resonance Top	0...100	Sets the upper limit of resonance amount when Mode=Custom	
d	Sweep Mode	Auto, D-mod, LFO	Selects the control from auto-wah, modulation source, and LFO	
	Src	Off...Tempo	Selects the modulation source for the wah when Sweep Mode=D-mod	
	Manual	0...100	Sets the center frequency when Sweep Mode=D-mod and Source=Off	
e	Envelope Sens	0...100	Sets the auto-wah sensitivity	
	Response	0...100	Sets the speed of response when Sweep Mode=Auto or D-mod	
f	LFO Frequency [Hz]	0.02...20.00	Sets the speed of the LFO	
	Src	Off...Tempo	Selects a modulation source for LFO speed	
	Amt	-20.00...+20.00	Sets the modulation amount of LFO speed	
g	MIDI Sync	Off, On	When this is on, the LFO speed is set by BPM, Base Note, and Times, instead of Frequency	
	BPM	MIDI, 40.00...300.00	MIDI syncs to the system tempo; 40-300 sets the tempo manually for this individual effect	
	Base Note	r...w	Selects the type of notes that specify the LFO speed	
	Times	x1...x32	Sets the number of notes that specify the LFO speed	
h	Output Level	0...100	Sets the output level of the effect sound	
	Src	Off...Tempo	Selects the modulation source that will control the effect output level	
	Amt	-100...+100	Sets the modulation amount of the effect output level	
i	Wet/Dry	Dry, 1:99...99:1, Wet	Balance between the wet and dry signal	
	Src	Off...Tempo	Table, "Dynamic Modulation sources," on page 357	
	Amt	-100...+100	Amount of modulation source	

a: Shape

This parameter specifies the sweep curve of the wah. It applies to all control via auto-wah, modulation source, and LFO, and lets you adjust subtle nuances of the wah effect.

a: Mode

b: Frequency Bottom

b: Frequency Top

c: Resonance Bottom

c: Resonance Top

If Mode=Preset, this simulates a vintage wah pedal. In this case, internally fixed values are used for Frequency Bottom/Top and Resonance Bottom/Top, and these settings will be ignored. The settings for Frequency Bottom/Top and Resonance Bottom/Top are valid if Mode=Custom.

12: St. Random Filter (Stereo Random Filter)

This stereo band pass filter uses a step-shape waveform and random LFO for modulation. You can create a special effect from filter oscillation.

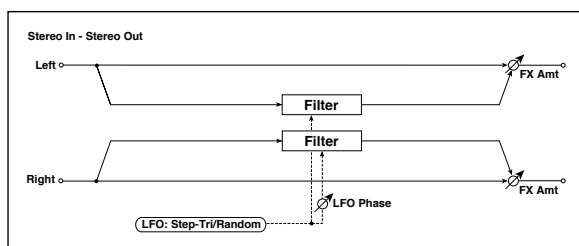

a	LFO Waveform	Step-Tri, Random	Selects the LFO Waveform	
	LFO Phase [degree]	-180...+180	Sets the LFO phase difference between the left and right	
b	LFO Frequency [Hz]	0.02...20.00	Sets the speed of the LFO	
	Src	Off...Tempo	Selects the modulation source used for both LFO speed and step speed	
c	Amt	-20.00...+20.00	Sets the modulation amount of LFO speed	
	LFO Step Freq [Hz]	0.05...50.00	Sets the LFO step speed (speed that changes in steps)	
d	Amt	-50.00...+50.00	Sets the modulation amount of LFO step speed	
	MIDI Sync	Off, On	When this is on, the LFO speed is set by BPM, Base Note, and Times, instead of Frequency	
e	BPM	MIDI, 40.00...300.00	MIDI syncs to the system tempo; 40-300 sets the tempo manually for this individual effect	
	Base Note	r...w	Selects the type of notes that specify the LFO speed	
	Times	x1...x32	Sets the number of notes that specify the LFO speed	
f	Step Base Note	r...w	Selects the type of notes to specify the LFO step speed	
	Times	x1...x32	Sets the number of notes to specify the LFO step speed	
g	Manual	0...100	Sets the filter center frequency	
	Src	Off...Tempo	Selects the modulation source for the filter center frequency	
	Amt	-100...+100	Sets the modulation amount for the filter center frequency	
h	Depth	0...100	Sets the modulation depth of filter center frequency	
	Src	Off...Tempo	Selects the modulation source of filter modulation	
i	Amt	-100...+100	Sets the modulation amount of filter modulation	
	Resonance	0...100	Sets the resonance amount	
i	Wet/Dry	-Wet, -1:99...Dry...99:1, Wet	Balance between the wet and dry signal	
	Src	Off...Tempo	Table, "Dynamic Modulation sources," on page 357	
	Amt	-100...+100	Amount of modulation source	

a: LFO Phase [degree]

Offsetting the left and right phases alters how modulation is applied to the left and right channels, creating a swelling affect.

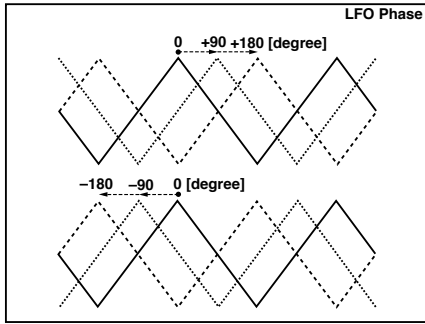

- a: LFO Waveform**
- b: LFO Frequency [Hz]**
- c: LFO Step Freq [Hz]**

When “LFO Waveform” is set to Step-Tri, LFO is a step-shape, triangle waveform. The “LFO Frequency” parameter sets the original triangle waveform speed. Changing the “LFO Step Freq” parameter enables you to adjust the width of the steps.

When “LFO Waveform” is set to Random, the “LFO Step Freq” parameter uses a random LFO cycle.

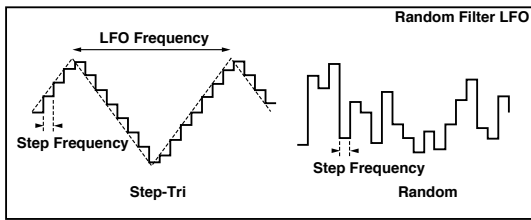

- d: BPM**
- e: Step Base Note**
- e: Times**

The width of an LFO step, or a cycle of random LFO, is obtained by multiplying the length of a note (r..w) (selected for “Step Base Note”, in relation to the tempo specified in “BPM,” or the MIDI Clock tempo if “BPM” is set to MIDI) by the number specified in the “Times” parameter.

i: Wet/Dry

The effect sound’s phase will be reversed when you set this parameter in the negative range of values.

**13: St. MultiModeFilter
(Stereo Multi Mode Filter)**

This is a multi-mode filter with four types; low pass, high pass, band pass, and band reject. You can use LFO or dynamic modulation to vary the cutoff frequency or resonance.

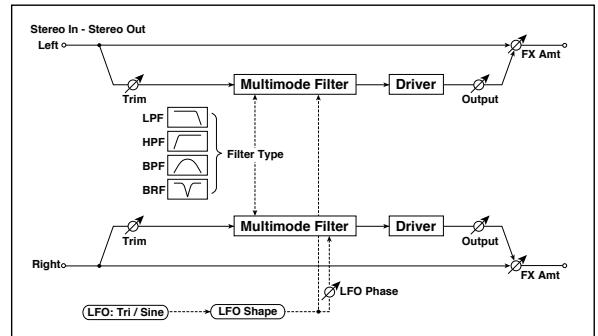

a	Type	LPF, HPF, BPF, BRF	Selects the type of filter	
	Trim	0...100	Sets the input level	
b	Cutoff	0...100	Sets the cutoff frequency (center frequency)	
	Src	Off...Tempo	Selects the modulation source of the cutoff	
c	Amt	-100...+100	Sets the modulation amount of the cutoff	
	Resonance	0...100	Sets the resonance amount	
d	Src	Off...Tempo	Selects the source that will modulate the amount of resonance	
	Amt	-100...+100	Sets the amount by which the resonance will be modulated	
e	LFO Waveform	Triangle, Sine	Selects the LFO Waveform	
	Phase [degree]	-180...+180	Sets the LFO phase difference between the left and right	
f	Depth	0...100	Sets the depth to which the LFO will modulate the cutoff frequency	
	LFO Frequency [Hz]	0.02...20.00	Sets the speed of the LFO	
g	Src	Off...Tempo	Selects a modulation source for LFO speed	
	Amt	-20.00...+20.00	Sets the modulation amount of LFO speed	
h	MIDI Sync	Off, On	When this is on, the LFO speed is set by BPM, Base Note, and Times, instead of Frequency	
	BPM	MIDI, 40.00...300.00	MIDI syncs to the system tempo; 40-300 sets the tempo manually for this individual effect	
	Base Note	r..w	Selects the type of notes that specify the LFO speed	
	Times	x1...x32	Sets the number of notes that specify the LFO speed	
i	Drive SW	Off, On	Switches distortion on/off within the filter	
	Output Level	0...100	Sets the output level	
j	Drive Gain	0...100	Sets the distortion amount	
	Low Boost	0...100	Sets the amount of low-range boost	
k	Wet/Dry	Dry, 1:99...99:1, Wet	Balance between the wet and dry signal	
	Src	Off...Tempo	Table, “Dynamic Modulation sources,” on page 357	
	Amt	-100...+100	Amount of modulation source	

14: St. Sub Oscillator (Stereo Sub Oscillator)

This effect adds very low frequencies to the input signal. It is very useful when simulating a roaring drum sound or emphasizing powerful low range. This effect is different from the equalizer in that you can add very low range harmonics. You can also adjust the oscillator frequency to match a particular note number, for use as an octaver.

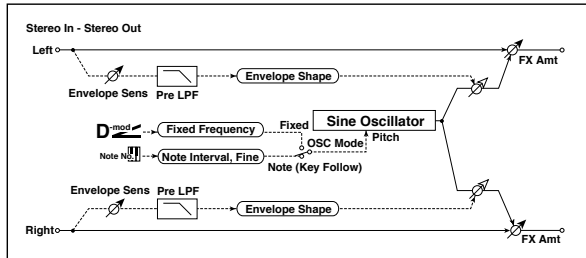

a	OSC Mode	Note (Key Follow), Fixed	Determines whether the oscillator frequency follows the note number or whether it is fixed	
b	Note Interval	-48...0	Sets the pitch difference from the note number when OSC Mode=Note (Key Follow)	
	Note Fine	-100...+100	Fine adjustment of the oscillator frequency	
c	Fixed Frequency [Hz]	10.0...80.0	Sets the oscillator frequency when OSC Mode=Fixed	
	Src	Off...Tempo	Selects the modulation source for the oscillator frequency when OSC Mode=Fixed	
	Amt	-80...+80	Sets the oscillator frequency modulation amount when OSC Mode=Fixed	
d	Envelope Pre LPF	1...100	Sets the upper limit of the frequency range for which very low harmonics are added	
e	Envelope Sens	0...100	Sets the sensitivity with which very low harmonics are added	
	Envelope Shape	-100...+100	Sets the oscillator's volume envelope curve	
f	Wet/Dry	Dry, 1:99...99:1, Wet	Balance between the wet and dry signal	
	Src	Off...Tempo	Table, "Dynamic Modulation sources," on page 357	
	Amt	-100...+100	Amount of modulation source	

- a: OSC Mode**
- b: Note Interval**
- b: Note Fine**

The "OSC Mode" parameter selects the oscillator operation mode. When Note (Key Follow) is selected, the oscillator's frequency is determined based on the note number, allowing you to use it as an octaver. The "Note Interval" parameter sets the pitch offset from the original note number by semitone steps. The "Note Fine" parameter allows you to fine-tune in steps of cents.

d: Envelope Pre LPF

This parameter sets the upper limit of the frequency range to which very low harmonics are added. Adjust this parameter if you do not want to add lower harmonics to the higher range.

15: Talking Modulator

This effect adds an unusual character, like a human voice, to the input signal. Modulating the tone via dynamic modulation, you can create an interesting effect that sounds as if the guitar or synthesizer is talking.

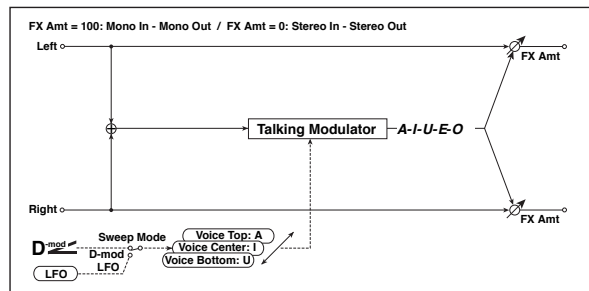

a	Sweep Mode	D-mod, LFO	Switches between modulation source control and LFO control	
b	Manual Voice Control	Bottom, 1...49, Center, 51...99, Top	Voice pattern control	
	Src	Off...Tempo	Selects the modulation source that controls the voice pattern	
c	Voice Top	A, I, U, E, O	Selects a vowel sound at the top end of control	
d	Voice Center	A, I, U, E, O	Selects a vowel sound in the center of control	
e	Voice Bottom	A, I, U, E, O	Selects a vowel sound at the bottom end of control	
f	Formant Shift	-100...+100	Sets the frequency to which the effect is applied	
	Resonance	0...100	Sets the Level of resonance of the voice pattern	
g	LFO Frequency [Hz]	0.02...20.00	Sets the speed of the LFO	
	Src	Off...Tempo	Selects a modulation source for LFO speed	
	Amt	-20.00...+20.00	Sets the modulation amount of LFO speed	
h	MIDI Sync	Off, On	When this is on, the LFO speed is set by BPM, Base Note, and Times, instead of Frequency	
	BPM	MIDI, 40.00...300.00	MIDI syncs to the system tempo; 40-300 sets the tempo manually for this individual effect	
	Base Note	r...w	Selects the type of notes that specify the LFO speed	
	Times	x1...x32	Sets the number of notes that specify the LFO speed	
i	Wet/Dry	Dry, 1:99...99:1, Wet	Balance between the wet and dry signal	
	Src	Off...Tempo	Table, "Dynamic Modulation sources," on page 357	
	Amt	-100...+100	Amount of modulation source	

- c: Voice Top
- d: Voice Center
- e: Voice Bottom

These parameters assign vowels to the top, center, and bottom position of the controller.

E.g.: When “Voice Top”=A, “Voice Center”=I, and “Voice Bottom”=U:

If “Sweep Mode” is set to D-mod and Ribbon is selected as the modulation source, moving your finger from the right to left of the ribbon controller will change the sound from “a” to “i,” then “u.”

If Sweep Mode is set to LFO, the sound will change cyclically from “a” to “i,” “u,” “i,” then “a.”

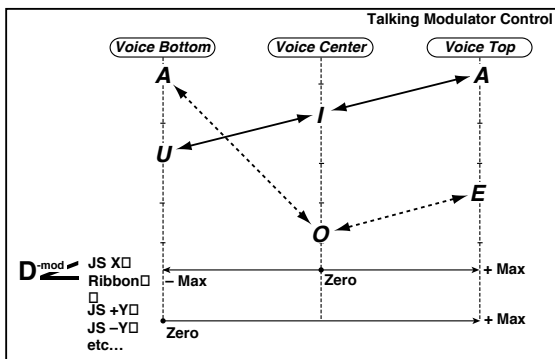

f: Formant Shift

This parameter adjusts the frequency level to which the effect is applied. If you wish to apply the effect to a higher-range sound, set this parameter to a higher value; to apply the effect to a lower-range sound, set this to a lower value.

f: Resonance

This parameter sets the intensity of resonance for the voice pattern. A larger value will add more character to the sound.

16: Stereo Decimator

This effect creates a rough sound like a cheap sampler by lowering the sampling frequency and data bit length. You can also simulate noise unique to a sampler (aliasing).

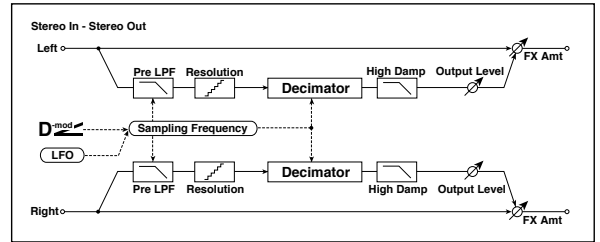

a	Pre LPF	Off, On	Selects whether the harmonic noise caused by a decrease in sampling frequency is generated or not	
	High Damp [%]	0...100	Sets the ratio of cut of the high range	
b	Sampling Freq [Hz]	1.00k... 48.00k	Sets the sampling frequency	
	Src	Off...Tempo	Selects the modulation source of the sampling frequency	
	Amt	-48.00k... +48.00k	Sets the modulation amount of the sampling frequency	
c	LFO Frequency [Hz]	0.02...20.00	Sets the speed of the LFO	
	Src	Off...Tempo	Selects a modulation source for LFO speed	
	Amt	-20.00... +20.00	Sets the modulation amount of LFO speed	
d	MIDI Sync	Off, On	When this is on, the LFO speed is set by BPM, Base Note, and Times, instead of Frequency	
	BPM	MIDI, 40.00... 300.00	MIDI syncs to the system tempo; 40-300 sets the tempo manually for this individual effect	
	Base Note	r...w	Selects the type of notes that specify the LFO speed	
	Times	x1...x32	Sets the number of notes that specify the LFO speed	
e	Depth	0...100	Sets the depth of the sampling frequency LFO modulation	
	Src	Off...Tempo	Selects the LFO modulation source of the sampling frequency	
	Amt	-100...+100	Sets the LFO modulation amount of the sampling frequency	
f	Resolution	4...24	Sets the data bit length	
g	Output Level	0...100	Sets the output level	
	Src	Off...Tempo	Selects the modulation source for the output level	
	Amt	-100...+100	Sets the modulation amount of the output level	
h	Wet/Dry	Dry, 1:99...99:1, Wet	Balance between the wet and dry signal	
	Src	Off...Tempo	Table, “Dynamic Modulation sources,” on page 357	
	Amt	-100...+100	Amount of modulation source	

a: Pre LPF

If a sampler with a very low sampling frequency receives very high-pitched sound that could not be heard during playback, it could generate pitch noise that is unrelated to the original sound. Set “Pre LPF” to On to prevent this noise from being generated.

If you set the “Sampling Freq” to about 3 kHz and set “Pre LPF” to Off, you can create a sound like a ring modulator.

f: Resonance

g: Output Level

If you set a smaller value for the “Resolution” parameter, the sound may be distorted. The volume level may also be changed. Use “Output Level” to adjust the level.

17: St. Analog Record (Stereo Analog Record)

This effect simulates the noise caused by scratches and dust on analog records. It also reproduces some of the modulation caused by a warped turntable.

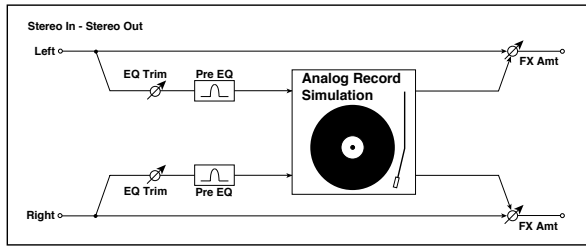

a	Speed [RPM]	33 1/3, 45, 78	Sets the r.p.m. of a record
b	Flutter	0...100	Sets the modulation depth
c	Noise Density	0...100	Sets the noise density
	Noise Tone	0...100	Sets the noise tone
d	Noise Level	0...100	Sets the noise level
	Src	Off...Tempo	Selects the modulation source for the noise level
	Amt	-100...+100	Sets the modulation amount of the noise level
e	Click Level	0...100	Sets the click noise level
	Src	Off...Tempo	Selects the modulation source for the click noise level
	Amt	-100...+100	Sets the modulation amount of the click noise level
f	EQ Trim	0...100	Sets the EQ input level
g	Pre EQ Cutoff [Hz]	300...10.00k	Sets the EQ center frequency
	Q	0.5...10.0	Sets the EQ band width
	Gain [dB]	-18.0...+18.0	Sets the EQ gain
h	Wet/Dry	Dry, 1:99...99:1, Wet	Balance between the wet and dry signal
	Src	Off...Tempo	Table, "Dynamic Modulation sources," on page 357
	Amt	-100...+100	Amount of modulation source

b: Flutter

This parameter enables you to set the depth of the modulation caused by a warped turntable.

e: Click Level

This parameter enables you to set the level of the click noise that occurs once every rotation of the turntable. This simulation reproduces record noise, and the noise generated after the music on a vinyl record finishes.

Overdrive, Amp models, and Mic models (OD Amp Mic)

18: OD/Hi.Gain Wah (Overdrive/Hi.Gain Wah)

This distortion effect utilizes an Overdrive mode and a Hi-Gain mode. Controlling the wah effect, the 3-band EQ, and the amp simulation will allow you to create versatile distortion sounds. This effect is suitable for guitar and organ sounds.

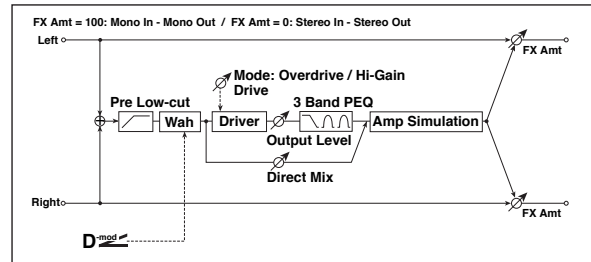

a	Wah	Off, On	Switches Wah on/off
	Src	Off...Tempo	Selects the modulation source that switches the Wah on and off
	Sw	Toggle, Moment	Selects the switching mode for the modulation source that switches the Wah on and off
b	Wah Sweep Range	-10...+10	Sets the range of Wah
	Wah Sweep Src	Off...Tempo	Selects the modulation source that controls the Wah
c	Drive Mode	Overdrive, Hi-Gain	Switches between overdrive and hi-gain distortion
d	Drive	1...100	Sets the degree of distortion
	Pre Low-cut	0...10	Sets the low range cut amount of the distortion input
e	Output Level	0...50	Sets the output level
	Src	Off...Tempo	Selects the modulation source for the output level
	Amt	-50...+50	Sets the modulation amount of the output level
f	Low Cutoff [Hz]	20...1.00k	Sets the center frequency for Low EQ (shelving type)
	Gain [dB]	-18...+18	Sets the gain of Low EQ
g	Mid1 Cutoff [Hz]	300...10.00k	Sets the center frequency for Mid/High EQ 1 (peaking type)
	Q	0.5...10.0	Sets the band width of Mid/High EQ 1
	Gain [dB]	-18...+18	Sets the gain of Mid/High EQ 1
h	Mid2 Cutoff [Hz]	500...20.00k	Sets the center frequency for Mid/High EQ 2 (peaking type)
	Q	0.5...10.0	Sets the band width of Mid/High EQ 2
	Gain [dB]	-18...+18	Sets the gain of Mid/High EQ 2
i	Direct Mix	0...50	Sets the amount of the dry sound mixed to the distortion
	Speaker Simulation	Off, On	Switches the speaker simulation on/off
j	Wet/Dry	Dry, 1:99...99:1, Wet	Balance between the wet and dry signal
	Src	Off...Tempo	Table, "Dynamic Modulation sources," on page 357
	Amt	-100...+100	Amount of modulation source

a: Wah

The Wah parameter switches the wah effect on/off.

a: Sw

This parameter sets how the wah effect is switched on and off via the modulation source.

When “Sw” = Moment, the wah effect is usually turned off. It is turned on only when you press the pedal or operate the joystick.

MIDI When a value for the modulation source is less than 64, “off” speed is selected, and when the value is 64 or higher, “on” is selected.

When “Sw” = Toggle, the wah effect is switched between on and off each time you press the pedal or operate the joystick.

MIDI The switch will be turned on/off each time the value of the modulation source exceeds 64.

b: Wah Sweep Range

b: Wah Sweep Src

This parameter sets the sweep range of the wah center frequency. A negative value will reverse the direction of sweep. The wah center frequency can be controlled by the modulation source specified in the “Wah Sweep Src” parameter.

d: Pre Low-cut

Cutting the signal in the low range before it is input to the Distortion will create a sharp distortion.

d: Drive

e: Output Level

The degree of distortion is determined by the level of input signal and the setting of “Drive”. Raising the “Drive” setting will cause the entire volume level to increase. Use the “Output Level” parameter to adjust the volume level. The “Output Level” parameter uses the signal level input to the 3-Band EQ. If clipping occurs at the 3-Band EQ, adjust the “Output Level” parameter.

19: St. Guitar Cabinet (Stereo Guitar Cabinet)

This simulates the acoustical character of a guitar amp’s speaker cabinet.

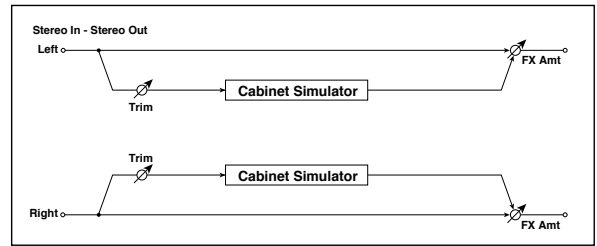

a	Trim	0...100	Sets the input level
b	Type	TWEED - 1x12	Selects the type of the cabinet Open-back cabinet with one 12" speaker, typically used for blues
		TWEED - 4x10	Open-back cabinet with four 10" speakers
		BLACK - 2x10	Open-back cabinet with two 10" speakers
		BLACK - 2x12	American open-back cabinet with two 12" speakers
		VOX AC15 - 1x12	Vox AC15 open-back cabinet with one 12" "Blue" speaker
		VOX AC30 - 2x12	Vox AC30 open-back cabinet with two 12" "Blue" speakers
		VOX AD412 - 4x12	VOX AD412 closed-back cabinet with four 12" speakers
		UK H30 - 4x12	Closed-back classic cabinet with four 30W 12" speakers
		UK T75 - 4x12	Closed-back cabinet with four 75W 12" speakers
US V30 - 4x12	Closed-back cabinet with four 30W 12" speakers		
c	Air	0...100	Sets the mic position
d	Wet/Dry	Dry, 1:99...99:1, Wet	Balance between the wet and dry signal
	Src	Off...Tempo	Table, "Dynamic Modulation sources," on page 357
	Amt	-100...+100	Amount of modulation source

20: St. Bass Cabinet (Stereo Bass Cabinet)

This simulates the acoustical character of a bass amp’s speaker cabinet.

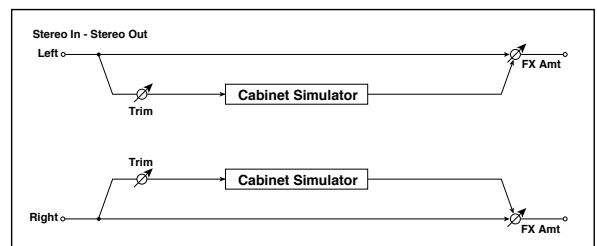

a	Trim	0...100	Sets the input level
---	------	---------	----------------------

b	Cabinet Type	LA - 4x10	Selects the cabinet type Four 10" speakers / LA sound cabinet
		MODERN - 4x10	Four 10" aluminum-cone speakers / modern cabinet
		METAL - 4x10	Four 10" aluminum-cone speakers / modern cabinet
		CLASSIC - 8x10	Eight 10" speakers / classic cabinet
		UK - 4x12	Four 12" speakers / UK-manufactured cabinet
		STUDIO - 1x15	One 15" speaker / studio combo cabinet
		JAZZ - 1x15	One 15" speaker / jazz combo cabinet
		VOX AC100 - 2x15	Two 15" speakers / cabinet for Vox AC100
		US - 2x15	Two 15" speakers / US-manufactured cabinet
		UK - 4x15	Four 15" speakers / UK-manufactured cabinet
c	Wet/Dry	Dry, 1:99...99:1, Wet	Balance between the wet and dry signal
	Src	Off...Tempo	Table, "Dynamic Modulation sources," on page 357
	Amt	-100...+100	Amount of modulation source

21: Bass Amp Model

This simulates a bass amp.

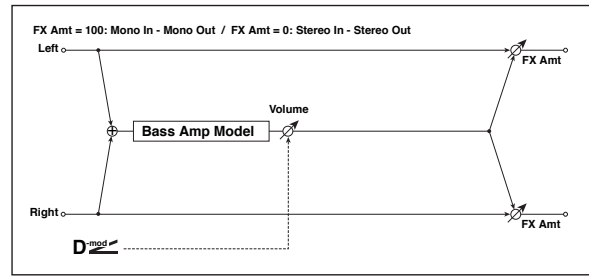

a	Amp Type	LA STUDIO	Selects the amplifier type An amp that is typical of the LA sound.
		JAZZ	A combo amp favored by jazz bassists.
		GOLD PANEL	An amp distinctive for its eye-catching gold panel and clean sound.
		SCOOPED	An amp typical of 80's sounds.
		VALVE2	A tube amp suitable for rock.
		VALVE	A tube amp with the ULTRA LO switch turned ON.
		CLASSIC	A tube amp whose basic character changes according to the setting of the value dial.
b	Volume	0...100	Sets the output level
	Src	Off...Tempo	Selects the modulation source for the output level
	Amt	-100...+100	Sets the modulation amount of the output level
c	Bass	0...100	Sets the bass (low range) level
d	Middle	0...100	Sets the middle (mid range) level
	Mid Range	0..4	Sets the mid-frequency range
e	Treble	0...100	Sets the treble (high range) level
f	Presence	0...100	Sets the presence (high-frequency tone)
g	Wet/Dry	Dry, 1:99...99:1, Wet	Balance between the wet and dry signal
	Src	Off...Tempo	Table, "Dynamic Modulation sources," on page 357
	Amt	-100...+100	Amount of modulation source

22: Bass Amp+Cabinet (Bass Amp Model+Cabinet)

This simulates a bass amp and speaker cabinet.

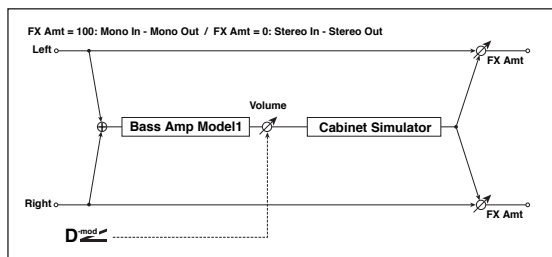

a	Amp Type	LA STUDIO, JAZZ, GOLD PANEL, SCOOPED, VALVE2, VALVE, CLASSIC	Selects the type of the amplifier
b	Volume	0...100	Sets the output level
	Src	Off...Tempo	Selects the modulation source for the output level
	Amt	-100...+100	Sets the modulation amount of the output level
c	Bass	0...100	Sets the bass (low range) level
d	Middle	0...100	Sets the middle (mid range) level
e	Mid Range	0...4	Sets the mid-frequency range
f	Treble	0...100	Sets the treble (high range) level
f	Presence	0...100	Sets the presence (high-frequency tone)
g	Cabinet Simulator	Off, On	Switches the cabinet simulator on/off
h	Cabinet Type	LA - 4x10, MODERN - 4x10, METAL - 4x10, CLASSIC - 8x10, UK - 4x12, STUDIO - 1x15, JAZZ - 1x15, VOX AC100 - 2x15, US - 2x15, UK - 4x15, LA - 1x18, COMBI - 1x12 & 1x18	Selects the cabinet type
i	Wet/Dry	Dry, 1:99...99:1, Wet	Balance between the wet and dry signal
	Src	Off...Tempo	Table, "Dynamic Modulation sources," on page 357
	Amt	-100...+100	Amount of modulation source

a: Amp Type

h: Cabinet Type

Recommended Combinations of Bass Amp Models and Cabinets:

Amp Type	Cabinet Type
LA STUDIO	LA - 4x10, LA - 1x18
JAZZ	JAZZ - 1x15
GOLD PANEL	MODERN - 4x10
SCOOPED	METAL - 4x10
VALVE2	CLASSIC - 8x10
VALVE	CLASSIC - 8x10
CLASSIC	COMBI - 1x12 & 1x18

23: Tube PreAmp Model (Tube PreAmp Modeling)

This effect simulates a two-stage vacuum tube preamp. You can make individual settings for two vacuum tubes connected in series. This lets you create the warm sound typical of vacuum tubes.

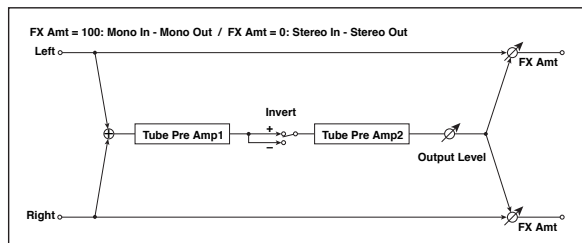

a	Tube1 Low Cut [Hz]	Thru, 21...8.00k	Sets the cutoff frequency for the low cut filter of stage 1
	High Cut [Hz]	53...20.00k, Thru	Sets the cutoff frequency for the high cut filter of stage 1
b	Tube1 Gain [dB]	-24.0...+24.0	Sets the input gain for stage 1
	Saturation [%]	0...100	Sets the input/output response for stage 1
c	Tube1 Bias	0...100	Sets the bias voltage for stage 1
d	Tube1 Phase	Normal, Wet Invert	Turns phase reversal on/off
e	Tube2 Low Cut [Hz]	Thru, 21...8.00k	Sets the cutoff frequency for the low cut filter of stage 2
	High Cut [Hz]	53...20.00k, Thru	Sets the cutoff frequency for the high cut filter of stage 2
f	Tube2 Gain [dB]	-24.0...+24.0	Sets the input gain for stage 2
	Saturation [%]	0...100	Sets the input/output response for stage 2
g	Tube2 Bias	0...100	Sets the bias voltage for stage 2
h	Tube2 Output Level [dB]	-48.0...+0.0	Sets the output level
i	Wet/Dry	Dry, 1:99...99:1, Wet	Balance between the wet and dry signal
	Src	Off...Tempo	Table, "Dynamic Modulation sources," on page 357
	Amt	-100...+100	Amount of modulation source

b, f: Saturation [%]

With higher settings of this value, the waveform will change at high gain levels, tending to cause distortion. Lower settings of this value will produce linear response.

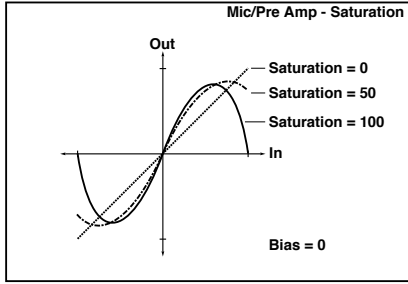

c: Tube1 Bias

This expresses the effect that changes in vacuum tube bias have on the distortion of the waveform. Higher settings of this value will produce distortion even at low gain levels. Since this will also change the overtone structure, you can use it to control the tonal character.

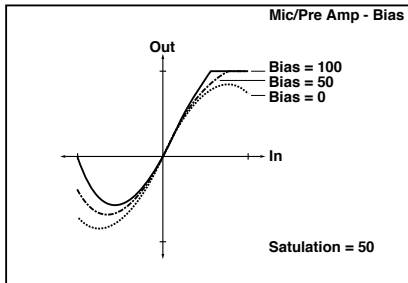

d: Tube1 Phase

With the Wet Invert setting, the phase of the signal will be inverted between stage 1 and stage 2. Since "Bias" is applied to the inverted signal in stage 2, this will change the tonal character.

**24: St. Tube PreAmp
(Stereo Tube PreAmp Modeling)**

This is a stereo vacuum tube preamp simulator (See "Tube Pre-Amp Model (Tube PreAmp Modeling)" on page 371.).

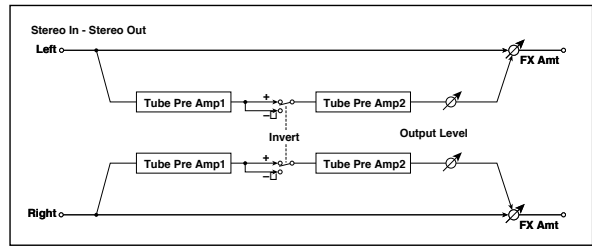

**25: Mic Model+PreAmp
(Mic Modeling + PreAmp)**

This effect simulates a mic and vacuum tube preamp. You can choose from various types of mic and positions to create differing sonic characters.

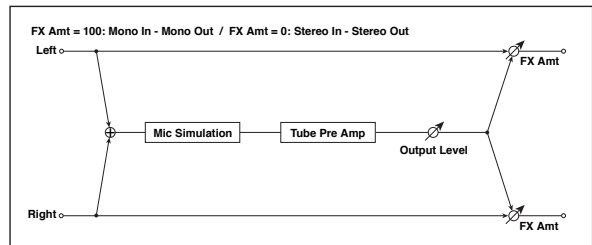

a	Mic Type	Vintage Dynamic, Multi Condenser, Percussion Condenser, Drums Dynamic, Vocal Dynamic, Multi Dynamic, Vocal Condenser, Vocal Tube, Kick Dynamic	Selects the type of mic	
b	Mic Position	Close, On, Off, Far	Sets the mic placement distance	
c	Tube Low Cut [Hz]	Thru, 21...8.00k	Sets the frequency of the low cut filter	
	High Cut [Hz]	53...20.00k, Thru	Sets the frequency of the high cut filter	
d	Tube Gain [dB]	-24.0...+24.0	Sets the input gain to the vacuum tube preamp	
	Saturation [%]	0...100	Sets the input/output response of the preamp	
e	Tube Bias	0...100	Sets the bias level of the preamp	
f	Tube Output Level [dB]	-48.0...+0.0	Sets the output level of the preamp	
g	Wet/Dry	Dry, 1:99...99:1, Wet	Balance between the wet and dry signal	
	Src	Off...Tempo	Table, "Dynamic Modulation sources," on page 357	
	Amt	-100...+100	Amount of modulation source	

b: Mic Position

This expresses the effect that the mic position has on the sound. The Close setting is the closest mic position, and the Far setting is the farthest.

Chorus, Flanger, and Phaser (Cho/Fln Phaser)

26: Stereo Chorus

This effect adds thickness and warmth to the sound by modulating the delay time of the input signal. You can add spread to the sound by offsetting the phase of the left and right LFOs from each other.

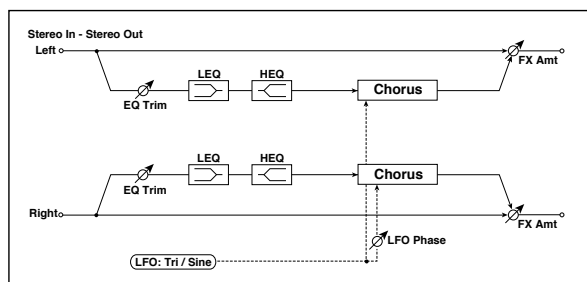

a	LFO Waveform	Triangle, Sine	Selects the LFO Waveform	
	LFO Phase [degree]	-180...+180	Selects the LFO phase difference between the left and right	
b	LFO Frequency [Hz]	0.02...20.00	Selects the speed of the LFO	
	Src	Off...Tempo	Selects a modulation source for LFO speed	
	Amt	-20.00...+20.00	Selects the modulation amount of LFO speed	
c	MIDI Sync	Off, On	When this is on, the LFO speed is set by BPM, Base Note, and Times, instead of Frequency	
	BPM	MIDI, 40.00...300.00	MIDI syncs to the system tempo; 40-300 sets the tempo manually for this individual effect	
	Base Note	r...w	Selects the type of notes that specify the LFO speed	
	Times	x1...x32	Selects the number of notes that specify the LFO speed	
d	L Pre Delay [msec]	0.0...50.0	Selects the delay time for the left channel	
	R Pre Delay [msec]	0.0...50.0	Selects the delay time for the right channel	
e	Depth	0...100	Selects the depth of LFO modulation	
	Src	Off...Tempo	Selects the modulation source for the LFO modulation depth	
	Amt	-100...+100	Selects the modulation amount of the LFO modulation depth	
f	EQ Trim	0...100	Selects the EQ input level	
g	Pre LEQ Fc	Low, Mid-Low	Selects the cutoff frequency (low or mid-low) of the low-range equalizer	
	Pre HEQ Fc	High, Mid-High	Selects the cutoff frequency (high or mid-high) of the high-range equalizer	
h	Pre LEQ Gain [dB]	-15.0...+15.0	Gain of the Low EQ	
	Pre HEQ Gain [dB]	-15.0...+15.0	Gain of the High EQ	
i	Wet/Dry	-Wet, -1:99...Dry...99:1, Wet	Balance between the wet and dry signal	
	Src	Off...Tempo	Table, "Dynamic Modulation sources," on page 357	
	Amt	-100...+100	Amount of modulation source	

d: L Pre Delay [msec]

d: R Pre Delay [msec]

Setting the left and right delay time individually allows you to control the stereo image.

27: Black Chorus/Flanger

This models a Danish-made stereo chorus + pitch modulator & flanger. Although this effect was originally intended for guitar, it was also used by numerous keyboard players. Used with electric piano, it produces a distinctive tone.

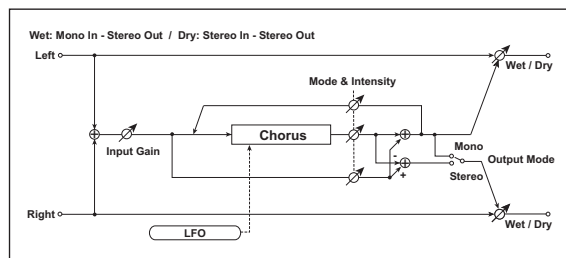

Speed [Hz]	0.10...10.0	Sets the LFO speed	
Intensity	1...100	Sets the intensity of LFO modulation	
Mode	0, 1, 2	Select a mode 0: Chorus 1: Pitch Modulation 2: Flanger	
Width	0...2	Sets the LFO modulation depth	
Input Gain	1...100	Sets the input gain	
Output Mode	0, 1	Select a output mode 0: Mono 1: Stereo	
Wet/Dry	Dry, 1:99 ... 99:1, Wet	Balance between the wet and dry signal	
Source	Off...Tempo	Table, "Selects a modulation source for Wet/Dry," on page 358	
Amount	-100 ... +100	Table, "Sets the modulation amount for Wet/Dry," on page 358	

Mode

Intensity

Increasing the "Intensity" value will strengthen the modulation effect. This controls the effect, direct, and feedback values. The values that are controlled will depend on the "Mode" setting.

28: St.HarmonicChorus (Stereo Harmonic Chorus)

This effect applies chorus only to higher frequencies. This can be used to apply a chorus effect to a bass sound without making the sound thinner. You can also use this chorus block with feedback as a flanger.

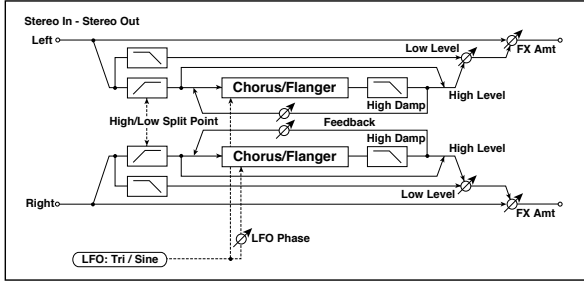

a	LFO Waveform	Triangle, Sine	Selects the LFO Waveform	
	LFO Phase [degree]	-180...+180	Sets the LFO phase difference between the left and right	
b	LFO Frequency [Hz]	0.02...20.00	Sets the speed of the LFO	
	Src	Off...Tempo	Selects a modulation source for LFO speed	
	Amt	-20.00...+20.00	Sets the modulation amount of LFO speed	
c	MIDI Sync	Off, On	When this is on, the LFO speed is set by BPM, Base Note, and Times, instead of Frequency	
	BPM	MIDI, 40.00...300.00	MIDI syncs to the system tempo; 40-300 sets the tempo manually for this individual effect	
	Base Note	r...w	Selects the type of notes that specify the LFO speed	
	Times	x1...x32	Sets the number of notes that specify the LFO speed	
d	Pre Delay [msec]	0.0...50.0	Sets the delay time from the original sound	
e	Depth	0...100	Sets the depth of LFO modulation	
	Amt	-100...+100	Sets the modulation amount of the LFO modulation depth	
f	High/Low Split Point	1...100	Sets the frequency split point between the low and high range	
g	Feedback	-100...+100	Sets the feed back amount of the chorus block	
	High Damp [%]	0...100	Sets the high range damping amount of the chorus block	
h	Low Level	0...100	Sets the low range output level	
	High Level	0...100	Sets the high range (chorus) output level	
i	Wet/Dry	Dry, 1:99...99:1, Wet	Balance between the wet and dry signal	
	Src	Off...Tempo	Table, "Dynamic Modulation sources," on page 357	
	Amt	-100...+100	Amount of modulation source	

f: High/Low Split Point

This parameter sets the frequency that splits the high and low range. Only the high range will be sent to the chorus block.

g: Feedback

Sets the feedback amount of the chorus block. Increasing the feedback will allow you to use the effect as a flanger.

29: St. Biphase Mod. (Stereo Biphase Modulation)

This stereo chorus effect adds two different LFOs together. You can set the Frequency and Depth parameters for each LFO individually. Depending on the setting of these LFOs, very complex waveforms will create an analog-type, unstable modulated sound.

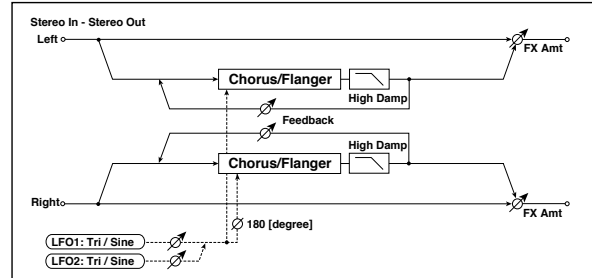

a	LFO1 Waveform	Triangle, Sine	Selects LFO1 waveform	
	LFO2	Triangle, Sine	Selects LFO2 waveform	
b	Phase Sw	0 deg, 180 deg	Switches the LFO phase difference between left and right	
	LFO1 Frequency [Hz]	0.02...30.00	Sets the LFO1 speed	
	Src	Off...Tempo	Selects the modulation source of LFO1&2 speed	
c	LFO1 Amt	-30.00...+30.00	Sets the modulation amount of LFO1 speed	
	LFO2 Frequency [Hz]	0.02...30.00	Sets the LFO2 speed	
d	Amt	-30.00...+30.00	Sets the modulation amount of LFO2 speed	
	Depth1	0...100	Sets the depth of LFO1 modulation	
e	Src	Off...Tempo	Selects the modulation source of LFO1&2 modulation depth	
	Amt	-100...+100	Sets the modulation amount of LFO1 modulation depth	
f	Depth2	0...100	Sets the depth of LFO2 modulation	
	Amt	-100...+100	Sets the modulation amount of LFO2 modulation depth	
g	L Pre Delay [msec]	0.0...50.0	Sets the delay time for the left channel	
	R Pre Delay [msec]	0.0...50.0	Sets the delay time for the right channel	
h	Feedback	-100...+100	Sets the feedback amount	
	High Damp [%]	0...100	Sets the damping amount in the high range	
i	Wet/Dry	-Wet, -1:99...Dry...99:1, Wet	Balance between the wet and dry signal	
	Src	Off...Tempo	Table, "Dynamic Modulation sources," on page 357	
	Amt	-100...+100	Amount of modulation source	

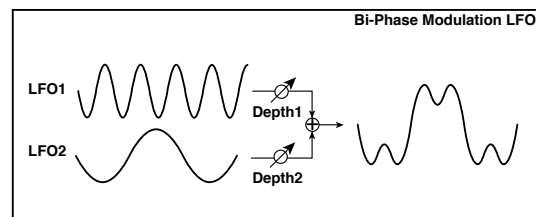

30: Multitap Cho/Delay (Multitap Chorus/Delay)

This effect has four chorus blocks with a different LFO phase. You can create a complex stereo image by setting each block's delay time, depth, output level, and pan individually. You can also fix some of the chorus blocks to combine the chorus and delay effects.

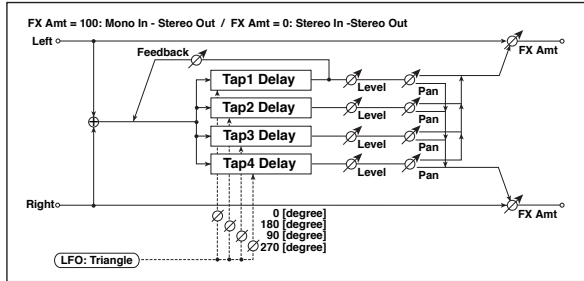

a	LFO Frequency [Hz]	0.02...13.00	Sets the speed of the LFO	
b	Tap1 (000) [msec]	0...1000	Sets the Tap1 (LFO phase=0 degrees) delay time	
	Depth	0...30	Sets the Tap1 chorus depth	
	Level	0...30	Sets the Tap1 output level	
	Pan	L6...L1, C, R1...R6	Sets the Tap1 stereo image	
c	Tap2 (180) [msec]	0...1000	Sets the Tap2 (LFO phase=180 degrees) delay time	
	Depth	0...30	Sets the Tap2 chorus depth	
	Level	0...30	Sets the Tap2 output level	
	Pan	L6...L1, C, R1...R6	Sets the Tap2 stereo image	
d	Tap3 (090) [msec]	0...1000	Sets the Tap3 (LFO phase=90 degrees) delay time	
	Depth	0...30	Sets the Tap3 chorus depth	
	Level	0...30	Sets the Tap3 output level	
	Pan	L6...L1, C, R1...R6	Sets the Tap3 stereo image	
e	Tap4 (270) [msec]	0...1000	Sets the Tap4 (LFO phase=270 degrees) delay time	
	Depth	0...30	Sets the Tap4 chorus depth	
	Level	0...30	Sets the Tap4 output level	
	Pan	L6...L1, C, R1...R6	Sets the Tap4 stereo image	
f	Tap1 Feedback	-100...+100	Sets the Tap1 feedback amount	
	Src	Off...Tempo	Selects the modulation source of Tap1 feedback amount and effect balance	
	Amt	-100...+100	Sets the Tap1 feedback amount and modulation amount	
g	Wet/Dry	Dry, 1:99...99:1, Wet	Balance between the wet and dry signal	
	Src	Off...Tempo	Table, "Dynamic Modulation sources," on page 357	
	Amt	-100...+100	Amount of modulation source	

31: Ensemble

This Ensemble effect has three chorus blocks that use LFO to create subtle shimmering, and gives three dimensional depth and spread to the sound, because the signal is output from the left, right, and center.

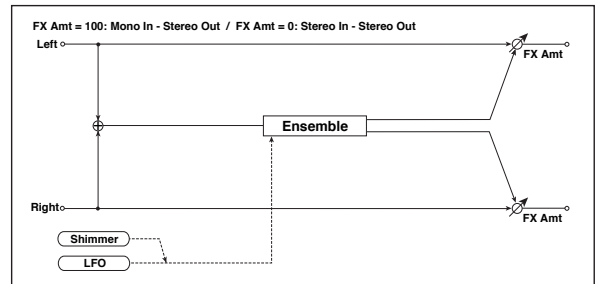

a	Speed	1...100	Sets the speed of the LFO	
	Src	Off...Tempo	Selects a modulation source for LFO speed	
	Amt	-100...+100	Sets the modulation amount of LFO speed	
b	Depth	0...100	Sets the depth of LFO modulation	
	Src	Off...Tempo	Selects the modulation source of the LFO modulation depth	
	Amt	-100...+100	Sets the modulation amount of the LFO modulation depth	
c	Shimmer	0...100	Sets the amount of shimmering of the LFO waveform	
d	Wet/Dry	Dry, 1:99...99:1, Wet	Balance between the wet and dry signal	
	Src	Off...Tempo	Table, "Dynamic Modulation sources," on page 357	
	Amt	-100...+100	Amount of modulation source	

c: Shimmer

This parameter sets the amount of shimmering of the LFO waveform. Increasing this value adds more shimmering, making the chorus effect more complex and richer.

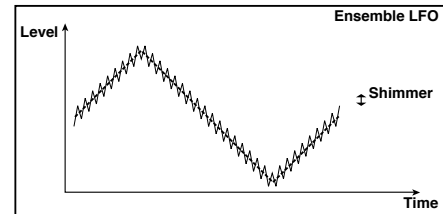

32: Polysix Ensemble

This models the ensemble effect built into the classic Korg PolySix programmable polyphonic synthesizer.

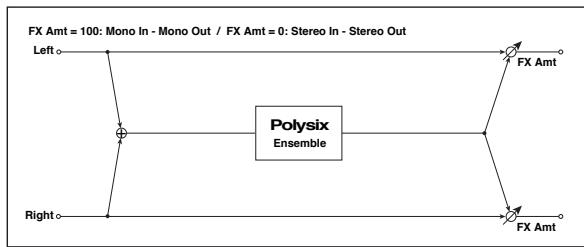

a	Depth	0...100	Sets the depth of the effect	
	Src	Off...Tempo	Selects the modulation source that will control the effect depth	
	Amt	-100...+100	Sets the amount by which the effect depth will be modulated	
b	Wet/Dry	Dry, 1:99...99:1, Wet	Balance between the wet and dry signal	
	Src	Off...Tempo	Table, "Dynamic Modulation sources," on page 357	
	Amt	-100...+100	Amount of modulation source	

33: Stereo Flanger

This effect gives a significant swell and movement of pitch to the sound. It is more effective when applied to a sound with a lot of harmonics. This is a stereo flanger. You can add spread to the sound by offsetting the phase of the left and right LFOs from each other.

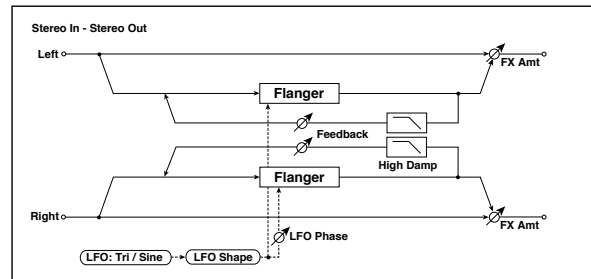

a	Delay Time [msec]	0.0...50.0	Sets the delay time from the original sound	
b	LFO Waveform	Triangle, Sine	Selects the LFO Waveform	
	LFO Shape	-100...+100	Changes the curvature of the LFO Waveform	
c	LFO Phase [degree]	-180...+180	Sets the LFO phase difference between the left and right	
d	LFO Frequency [Hz]	0.02...20.00	Sets the speed of the LFO	
	Src	Off...Tempo	Selects a modulation source for LFO speed	
	Amt	-20.00...+20.00	Sets the modulation amount of LFO speed	
e	MIDI Sync	Off, On	When this is on, the LFO speed is set by BPM, Base Note, and Times, instead of Frequency	
	BPM	MIDI, 40.00...300.00	MIDI syncs to the system tempo; 40-300 sets the tempo manually for this individual effect	
	Base Note	r...w	Selects the type of notes that specify the LFO speed	
	Times	x1...x32	Sets the number of notes that specify the LFO speed	
f	Depth	0...100	Sets the depth of LFO modulation	
g	Feedback	-100...+100	Sets the feedback amount	
	High Damp [%]	0...100	Sets the feedback damping amount in the high range	
h	Wet/Dry	-Wet, -1:99...Dry...99:1, Wet	Balance between the wet and dry signal	
	Src	Off...Tempo	Table, "Dynamic Modulation sources," on page 357	
	Amt	-100...+100	Amount of modulation source	

g: Feedback

h: Wet/Dry

The peak shape of the positive and negative "Feedback" value is different. The harmonics will be emphasized when the effect sound is mixed with the dry sound if you set a positive value for both "Feedback" and "Wet/Dry", and if you set a negative value for both "Feedback" and "Wet/Dry".

g: High Damp [%]

This parameter sets the amount of damping of the feedback in the high range. Increasing the value will cut high-range harmonics.

34: St. Random Flanger (Stereo Random Flanger)

The stereo effect uses a step-shape waveform and random LFO for modulation, creating a unique flanging effect.

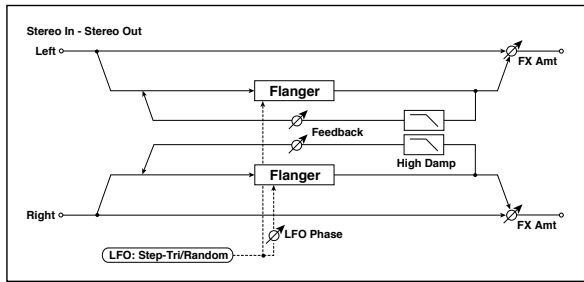

a	Delay Time [msec]	0.0...50.0	Sets the delay time from the original sound	
b	LFO Waveform	Step-Tri, Random	Selects the LFO Waveform	
	LFO Phase [degree]	-180...+180	Sets the LFO phase difference between the left and right	
c	LFO Frequency [Hz]	0.02...20.00	Sets the speed of the LFO	
	Src	Off...Tempo	Selects the modulation source used for both LFO speed and step speed	
	Amt	-20.00...+20.00	Sets the modulation amount of LFO speed	
d	LFO Step Freq [Hz]	0.05...50.00	Sets the LFO step speed (speed that changes in steps)	
	Step Amt	-50.00...+50.00	Sets the modulation amount of LFO step speed	
e	MIDI Sync	Off, On	When this is on, the LFO speed is set by BPM, Base Note, and Times, instead of Frequency	
	BPM	MIDI, 40.00...300.00	MIDI syncs to the system tempo; 40-300 sets the tempo manually for this individual effect	
	Base Note	r...w	Selects the type of notes that specify the LFO speed	
	Times	x1...x32	Sets the number of notes that specify the LFO speed	
f	Step Base Note	r...w	Selects the type of notes to specify the LFO step speed	
	Times	x1...x32	Sets the number of notes to specify the LFO step speed	
g	Depth	0...100	Sets the depth of LFO modulation	
h	Feedback	-100...+100	Sets the feedback amount	
	High Damp [%]	0...100	Sets the feedback damping amount in the high range	
i	Wet/Dry	-Wet, -1:99...Dry...99:1, Wet	Balance between the wet and dry signal	
	Src	Off...Tempo	Table, "Dynamic Modulation sources," on page 357	
	Amt	-100...+100	Amount of modulation source	

35: St. Env. Flanger (Stereo Envelope Flanger)

This Flanger uses an envelope generator for modulation. You will obtain the same pattern of flanging each time you play. You can also control the Flanger directly using the modulation source.

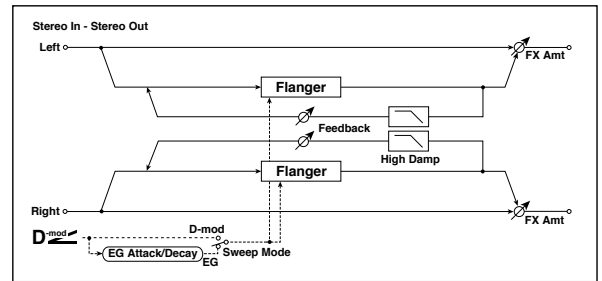

a	L Dly Bottom [msec]	0.0...50.0	Sets the lower limit of the left-channel delay time	
	L Dly Top [msec]	0.0...50.0	Sets the upper limit of the left-channel delay time	
b	R Dly Bottom [msec]	0.0...50.0	Sets the lower limit of the right-channel delay time	
	R Dly Top [msec]	0.0...50.0	Sets the upper limit of the right-channel delay time	
c	Sweep Mode	EG, D-mod	Determines whether the flanger is controlled by the envelope generator or by the modulation source	
	Src	Off...Tempo	Selects the modulation source that triggers the EG (when Sweep Mode = EG), or the modulation source that causes the flanger to sweep (when Sweep Mode = D-mod)	
d	EG Attack	1...100	Sets the EG attack speed	
	EG Decay	1...100	Sets the EG decay speed	
e	Feedback	-100...+100	Sets the feedback amount	
f	High Damp [%]	0...100	Sets the feedback damping amount in the high range	
g	Wet/Dry	-Wet, -1:99...Dry...99:1, Wet	Balance between the wet and dry signal	
	Src	Off...Tempo	Table, "Dynamic Modulation sources," on page 357	
	Amt	-100...+100	Amount of modulation source	

c: Sweep Mode

c: Src

This parameter switches the flanger control mode. With "Sweep Mode" = EG, the flanger will sweep using the envelope generator. This envelope generator is included in the envelope flanger, and not related to the Pitch EG, Filter EG, or Amp EG.

The "Src" parameter selects the source that starts the envelope generator. If you select, for example, Gate, the envelope generator will start when the note-on message is received.

When "Sweep Mode" = D-mod, the modulation source can control the flanger directly. Select the modulation source using the "Src" parameter.

MIDI The effect is off when a value for the modulation source specified for the "Src" parameter is smaller than 64, and the effect is on when the value is 64 or higher. The Envelope Generator is triggered when the value changes from 63 or smaller to 64 or higher.

d: EG Attack

d: EG Decay

Attack and Decay speed are the only adjustable parameters on this EG.

36: Stereo Phaser

This effect creates a swell by shifting the phase. It is very effective on electric piano sounds. You can add spread to the sound by offsetting the phase of the left and right LFOs from each other.

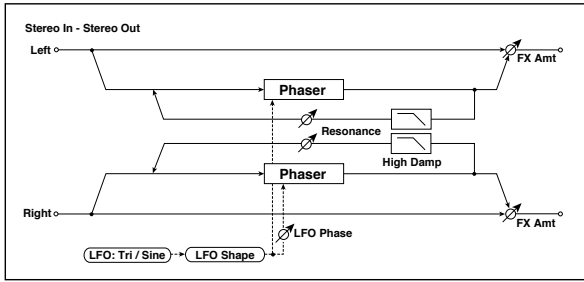

a	LFO Waveform	Triangle, Sine	Selects the LFO Waveform	
	LFO Shape	-100...+100	Changes the curvature of the LFO Waveform	
b	LFO Phase [degree]	-180...+180	Sets the LFO phase difference between the left and right	
c	LFO Frequency [Hz]	0.02...20.00	Sets the speed of the LFO	
	Src	Off...Tempo	Selects a modulation source for LFO speed	
d	Amt	-20.00...+20.00	Sets the modulation amount of LFO speed	
	MIDI Sync	Off, On	When this is on, the LFO speed is set by BPM, Base Note, and Times, instead of Frequency	
	BPM	MIDI, 40.00...300.00	MIDI syncs to the system tempo; 40-300 sets the tempo manually for this individual effect	
	Base Note	r...w	Selects the type of notes that specify the LFO speed	
e	Times	x1...x32	Sets the number of notes that specify the LFO speed	
	Manual	0...100	Sets the frequency to which the effect is applied	
	Src	Off...Tempo	Selects the modulation source for the LFO modulation	
f	Amt	-100...+100	Sets the modulation amount of the LFO modulation	
	Depth	0...100	Sets the depth of LFO modulation	
g	Src	Off...Tempo	Selects the modulation source for the LFO modulation depth	
	Amt	-100...+100	Sets the modulation amount of the LFO modulation depth	
h	Resonance	-100...+100	Sets the resonance amount	
	High Damp [%]	0...100	Sets the resonance damping amount in the high range	
i	Wet/Dry	-Wet, -1:99...Dry...99:1, Wet	Balance between the wet and dry signal	
	Src	Off...Tempo	Table, "Dynamic Modulation sources," on page 357	
	Amt	-100...+100	Amount of modulation source	

h: Resonance

i: Wet/Dry

The peak shape of the positive and negative Feedback value is different. The harmonics will be emphasized when the effect sound is mixed with the dry sound, if you set a positive value for both "Resonance" and "Wet/Dry", and if you set a negative value for both "Resonance" and "Wet/Dry".

h: High Damp [%]

This parameter sets the amount of damping of the resonance in the high range. Increasing the value will cut high-range harmonics.

37: St. Random Phaser (Stereo Random Phaser)

This is a stereo phaser. The effect uses a step-shape waveform and random LFO for modulation, creating a unique phasing effect.

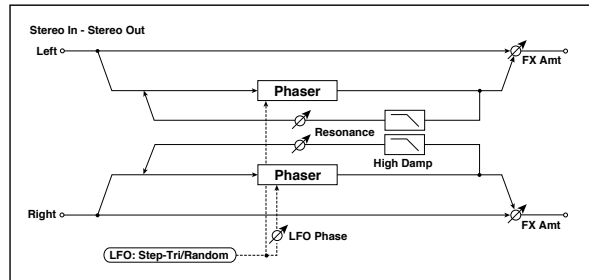

a	LFO Waveform	Step-Tri, Step-Sin, Random	Selects the LFO Waveform	
	LFO Phase [degree]	-180...+180	Sets the LFO phase difference between the left and right	
b	LFO Frequency [Hz]	0.02...20.00	Sets the speed of the LFO	
	Src	Off...Tempo	Selects the modulation source commonly used for LFO speed and step speed	
c	Amt	-20.00...+20.00	Sets the modulation amount of LFO speed	
	LFO Step Freq [Hz]	0.05...50.00	Sets the LFO step speed	
d	Amt	-50.00...+50.00	Sets the modulation amount of LFO step speed	
	MIDI Sync	Off, On	When this is on, the LFO speed is set by BPM, Base Note, and Times, instead of Frequency	
	BPM	MIDI, 40.00...300.00	MIDI syncs to the system tempo; 40-300 sets the tempo manually for this individual effect	
e	Base Note	r...w	Selects the type of notes that specify the LFO speed	
	Times	x1...x32	Sets the number of notes that specify the LFO speed	
f	Step Base Note	r...w	Selects the type of notes to specify the LFO step speed	
	Times	x1...x32	Sets the number of notes to specify the LFO step speed	
g	Manual	0...100	Sets the frequency to which the effect is applied	
	Src	Off...Tempo	Selects the modulation source for the LFO modulation	
	Amt	-100...+100	Sets the modulation amount of the LFO modulation	
h	Depth	0...100	Sets the depth of LFO modulation	
	Resonance	-100...+100	Sets the resonance amount	
i	High Damp [%]	0...100	Sets the resonance damping amount in the high range	
	Wet/Dry	-Wet, -1:99...Dry...99:1, Wet	Balance between the wet and dry signal	
j	Src	Off...Tempo	Table, "Dynamic Modulation sources," on page 357	
	Amt	-100...+100	Amount of modulation source	

38: St. Env. Phaser (Stereo Envelope Phaser)

This stereo phaser uses an envelope generator for modulation. You will obtain the same pattern of phasing each time you play. You can also control the Phaser directly using the modulation source.

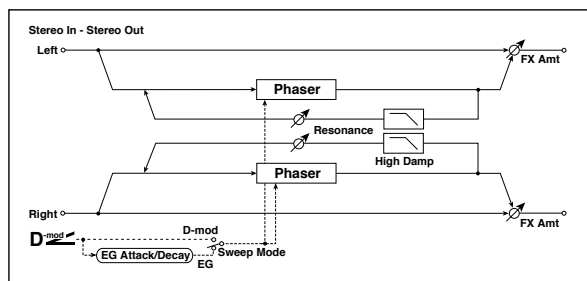

a	L Manu Bottom	0...100	Sets the lower limit of the frequency range for the effect on the left channel
	L Manu Top	0...100	Sets the upper limit of the frequency range for the effect on the left channel
b	R Manu Bottom	0...100	Sets the lower limit of the frequency range for the effect on the right channel
	R Manu Top	0...100	Sets the upper limit of the frequency range for the effect on the right channel
c	Sweep Mode	EG, D-mod	Determines whether the flanger is controlled by the envelope generator or by the modulation source
	Src	Off...Tempo	Selects the modulation source that triggers the EG (when EG is selected for Sweep Mode), or modulation source that causes the flanger to sweep (when D-mod is selected for Sweep Mode)
d	EG Attack	1...100	Sets the EG attack speed
	EG Decay	1...100	Sets the EG decay speed
e	Resonance	-100...+100	Sets the resonance amount
f	High Damp [%]	0...100	Sets the resonance damping amount in the high range
g	Wet/Dry	-Wet, -1:99...Dry...99:1, Wet	Balance between the wet and dry signal
	Src	Off...Tempo	Table, "Dynamic Modulation sources," on page 357
	Amt	-100...+100	Amount of modulation source

Modulation and Pitch Shift (Mod./P.Shift)

39: Stereo Vibrato

This effect causes the pitch of the input signal to shimmer. Using the AutoFade allows you to increase or decrease the shimmering speed.

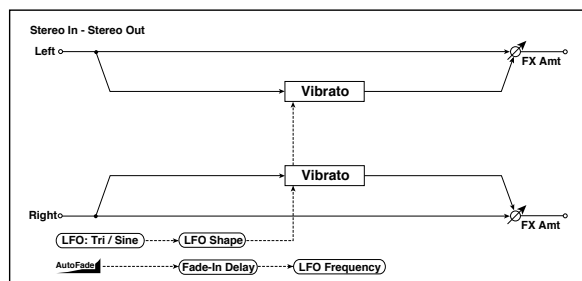

a	AUTOFADE Src	Off...Tempo	Selects the modulation source that starts AutoFade
b	Fade-In Delay [msec]	00...2000	Sets the fade-in delay time
	Fade-In Rate	1...100	Sets the rate of fade-in
c	LFO Waveform	Triangle, Sine	Selects the LFO Waveform
	LFO Shape	-100...+100	Changes the curvature of the LFO Waveform
d	LFO Frequency Mod	D-mod, AUTOFADE	Switches between D-mod and AUTOFADE for the LFO frequency modulation
e	LFO Frequency [Hz]	0.02...20.00	Sets the speed of the LFO
	Src	Off...Tempo	Selects a modulation source for LFO speed
	Amt	-20.00...+20.00	Sets the modulation amount of LFO speed
f	MIDI Sync	Off, On	When this is on, the LFO speed is set by BPM, Base Note, and Times, instead of Frequency
	BPM	MIDI, 40.00...300.00	MIDI syncs to the system tempo; 40-300 sets the tempo manually for this individual effect
	Base Note	r...w	Selects the type of notes that specify the LFO speed
	Times	x1...x32	Sets the number of notes that specify the LFO speed
g	Depth	0...100	Sets the depth of LFO modulation
	Src	Off...Tempo	Selects the modulation source of the LFO modulation depth
	Amt	-100...+100	Sets the modulation amount of the LFO modulation depth
h	Wet/Dry	Dry, 1:99...99:1, Wet	Balance between the wet and dry signal
	Src	Off...Tempo	Table, "Dynamic Modulation sources," on page 357
	Amt	-100...+100	Amount of modulation source

- a: AUTOFADE Src
- b: Fade-In Delay [msec]
- b: Fade-In Rate
- d: LFO Frequency Mod

When “LFO Frequency Mod” is set to AUTOFADE, you can use the modulation source selected in “AUTOFADE Src” as a trigger to automatically fade in the modulation amount. When “MIDI Sync” is set to On, you cannot use this.

The “Fade-In Rate” parameter specifies the rate of fade-in. The “Fade-In Delay” parameter determines the time from AutoFade modulation source On until the fade-in starts.

The following is an example of fade-in where the LFO speed is increased from “1.0Hz” to “4.0Hz” when a note-on message is received.

AUTOFADE Src=Gate1, LFO Frequency Mod=AUTOFADE, LFO Frequency [Hz]=1.0, Amt=3.0

MIDI The effect is off when a value for the dynamic modulation source specified for the “AUTOFADE Src” parameter is smaller than 64, and the effect is on when the value is 64 or higher. The AutoFade function is triggered when the value changes from 63 or smaller to 64 or higher.

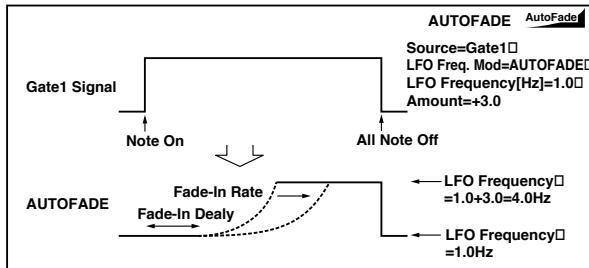

40: St. Auto Fade Mod. (Stereo Auto Fade Modulation)

This stereo chorus/flanger effect enables you to control the LFO speed and effect balance using auto fade, and you can spread the sound by offsetting the phase of the left and right LFOs from each other.

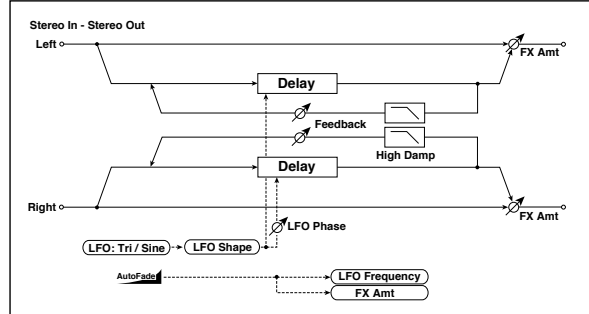

a	AUTOFADE Src	Off...Tempo	Selects the modulation source that starts AutoFade	
	Fade-In Delay [msec]	00...2000	Sets the fade-in delay time	
	Rate	1...100	Sets the rate of fade-in	
b	LFO Frequency Mod	D-mod, AUTOFADE	Switches between D-mod and AUTOFADE for the LFO frequency modulation	
	Wet/Dry Mod	D-mod, AUTOFADE	Switches between D-mod and AUTOFADE for the effect balance modulation	
c	LFO Waveform	Triangle, Sine	Selects the LFO Waveform	
	LFO Shape	-100...+100	Changes the curvature of the LFO Waveform	
d	LFO Phase [degree]	-180...+180	Sets the LFO phase difference between the left and right	
	LFO Frequency [Hz]	0.02...20.00	Sets the speed of the LFO	
e	Src	Off...Tempo	Selects a modulation source for LFO speed	
	Amt	-20.00...+20.00	Sets the modulation amount of LFO speed	
f	L Delay Time [msec]	0.0...500.0	Sets the left channel delay time	
	R Delay Time [msec]	0.0...500.0	Sets the right channel delay time	
g	Depth	0...200	Sets the depth of LFO modulation	
	Feedback	-100...+100	Sets the feedback amount	
h	High Damp [%]	0...100	Sets the feedback damping amount in the high range	
	Wet/Dry	-Wet, -1:99...Dry...99:1, Wet	Balance between the wet and dry signal	
i	Src	Off...Tempo	Table, “Dynamic Modulation sources,” on page 357	
	Amt	-100...+100	Amount of modulation source	

41: 2Voice Resonator

This effect resonates the input signal at a specified pitch. You can set the pitch, output level, and pan settings for two resonators individually. You can control the resonance intensity via an LFO.

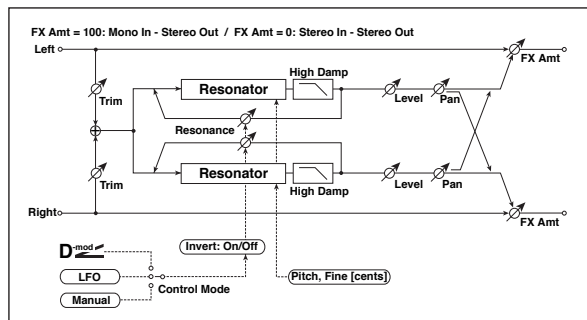

a	Control Mode	Manual, LFO, D-mod	Switches the controls of resonance intensity	
	LFO/D-mod Invert	Off, On	Reverses the Voice 1 and 2 control when LFO/D-mod is selected	
b	LFO Frequency [Hz]	0.02...20.00	Sets the speed of the LFO	
	D-mod Src	Off...Tempo	Selects the modulation source that controls resonance intensity	
c	MIDI Sync	Off, On	When this is on, the LFO speed is set by BPM, Base Note, and Times, instead of Frequency	
	BPM	MIDI, 40.00...300.00	MIDI syncs to the system tempo; 40-300 sets the tempo manually for this individual effect	
	Base Note	r...w	Selects the type of notes that specify the LFO speed	
	Times	x1...x32	Sets the number of notes that specify the LFO speed	
d	Mod. Depth	-100...+100	Sets the amount of resonance intensity control via LFO/D-mod	
	Trim	0...100	Sets the input level at the resonator	
e	Voice1: Pitch	C0...B8	Sets the voice1 Pitch for resonance	
	Fine [cents]	-50...+50	Fine-adjusts the voice 1 pitch for resonance	
f	Level	0...100	Sets the Voice1 output level	
	Voice1: Resonance	-100...+100	Sets the intensity of resonance when Control Mode = Manual	
	High Damp [%]	0...100	Sets the damping amount of resonant sound in the high range	
g	Pan	L6...L1, C, R1...R6	Sets the Voice1 stereo image	
	Voice2: Pitch	C0...B8	Sets the voice 2 Pitch for resonance	
	Fine [cents]	-50...+50	Fine-adjusts the voice 2 pitch for resonance	
h	Level	0...100	Sets the Voice2 output level	
	Voice2: Resonance	-100...+100	Sets the intensity of resonance when Control Mode = Manual	
	High Damp [%]	0...100	Sets the damping amount of resonant sound in the high range	
i	Pan	L6...L1, C, R1...R6	Sets the Voice2 stereo image	
	Wet/Dry	Dry, 1:99...99:1, Wet	Balance between the wet and dry signal	
	Src	Off...Tempo	Table , "Dynamic Modulation sources," on page 357	
	Amt	-100...+100	Amount of modulation source	

a: Control Mode

f: Voice 1: Resonance

h: Voice 2: Resonance

This parameter determines the resonance intensity.

When "Control Mode" = Manual, the "Resonance" parameter sets the intensity of resonance. If the "Resonance" parameter has a negative value, harmonics will be changed, and resonance will occur at a pitch one octave lower.

When "Control Mode" = LFO, the intensity of resonance varies according to the LFO. The LFO sways between positive and negative values, causing resonance to occur between specified pitches an octave apart in turn.

When "Control Mode" = D-mod, the resonance is controlled by the dynamic modulation source. If JS X or Ribbon is assigned as the modulation source, the pitch an octave higher and lower can be controlled, similar to when LFO is selected for Control Mode.

a: LFO/D-mod Invert

When "Control Mode" = LFO or D-mod, the controlled phase of either Voice 1 or 2 will be reversed. When the resonance pitch is set for Voice 1 (Resonance has a positive value), Voice 2 will resonate at a pitch an octave below (Resonance has a negative value).

f: Voice 1: Pitch

f: Fine [cents]

h: Voice 2: Pitch

h: Fine [cents]

The Pitch parameter specifies the pitch of resonance by note name. The "Fine" parameter allows for fine adjustment in steps of cents.

g: High Damp [%]

i: High Damp [%]

This sets the amount of damping amount for the high frequencies of the resonant sound. Lower values create a metallic sound with a higher range of harmonics.

42: Doppler

This effect simulates the “Doppler effect” of a moving sound with a changing pitch, similar to the siren of an passing ambulance. Mixing the effect sound with the dry sound will create a unique chorus effect.

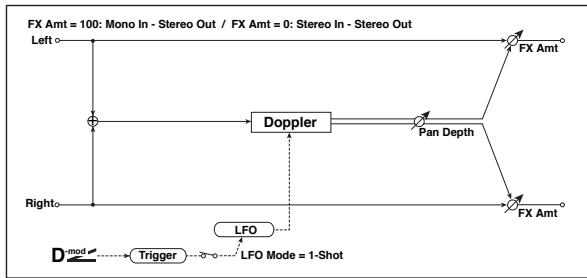

a	LFO Mode	Loop, 1-Shot	Switches LFO operation mode	
	Src	Off...Tempo	Selects the modulation source of LFO reset	
b	LFO Sync	Off, On	Switches between LFO reset on and off when LFO Mode is set to Loop	
c	LFO Frequency [Hz]	0.02...20.00	Sets the speed of the LFO	
	Src	Off...Tempo	Selects a modulation source for LFO speed	
d	Amt	-20.00...+20.00	Sets the modulation amount of LFO speed	
	MIDI Sync	Off, On	When this is on, the LFO speed is set by BPM, Base Note, and Times, instead of Frequency	
	BPM	MIDI, 40.00...300.00	MIDI syncs to the system tempo; 40-300 sets the tempo manually for this individual effect	
	Base Note	r...w	Selects the type of notes that specify the LFO speed	
e	Times	x1...x32	Sets the number of notes that specify the LFO speed	
	Pitch Depth	0...100	Sets the pitch variation of the moving sound	
f	Src	Off...Tempo	Selects the modulation source of pitch variation	
	Amt	-100...+100	Sets the modulation amount of pitch variation	
g	Pan Depth	-100...+100	Sets the panning of the moving sound	
	Src	Off...Tempo	Selects the modulation source of panning	
h	Amt	-100...+100	Sets the modulation amount of panning	
	Wet/Dry	Dry, 1:99...99:1, Wet	Balance between the wet and dry signal	
i	Src	Off...Tempo	Table, “Dynamic Modulation sources,” on page 357	
	Amt	-100...+100	Amount of modulation source	

a: LFO Mode

a: Src

b: LFO Sync

The “LFO Mode” parameter switches LFO operation mode. When Loop is selected, the Doppler effect will be created repeatedly. If “LFO Sync” is set to On, the LFO will be reset when the modulation source specified with the “Src” parameter is turned on.

When “LFO Mode” is set to 1-Shot, the Doppler effect is created only once when the modulation source specified in the “Src” field is turned on. At this time if you do not set the “Src” parameter, the Doppler effect will not be created, and no effect sound will be output.

MIDI The effect is off when a value for the modulation source specified for the “Src” parameter is smaller than 64, and the effect is on when the value is 64 or higher. The Doppler effect is triggered when the value changes from 63 or smaller to 64 or higher.

e: Pitch Depth

With the Doppler effect, the pitch is raised when the sound approaches, and the pitch is lowered when the sound goes away. This parameter sets this pitch variation.

f: Pan Depth

This parameter sets the width of the stereo image of the effect sound. With larger values, the sound seems to come and go from much further away. With positive values, the sound moves from left to right; with negative values, the sound moves from right to left.

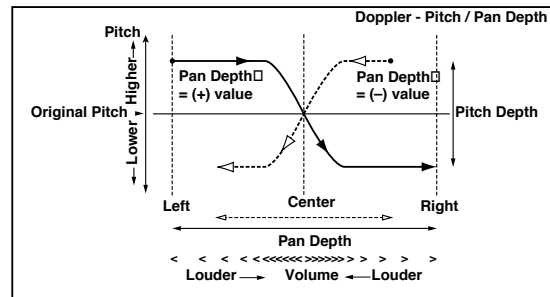

43: Scratch

This effect is applied by recording the input signal and moving the modulation source. It simulates the sound of scratches you can make using a turntable.

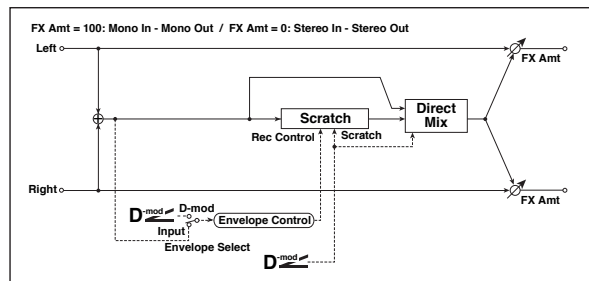

a	Scratch Source	Off...Tempo	Selects the modulation source for simulation control	
b	Response	0...100	Sets the speed of the response to the Scratch Src	
c	Envelope Select	D-mod, Input	Selects whether the start and end of recording is controlled via the modulation source or the input signal level	
	Src	Off...Tempo	Selects the modulation source that controls recording when Envelope Select is set to D-mod	
d	Threshold	0...100	Sets the recording start level when Envelope Select is set to Input	
e	Response	0...100	Sets the speed of the response to the end of recording	
f	Direct Mix	Always On, Always Off, Cross Fade	Selects how a dry sound is mixed	
g	Wet/Dry	Dry, 1:99...99:1, Wet	Balance between the wet and dry signal	
	Src	Off...Tempo	Table, “Dynamic Modulation sources,” on page 357	
	Amt	-100...+100	Amount of modulation source	

a: Scratch Source

b: Response

The Scratch Source parameter enables you to select the modulation source that controls simulation. The value of the modulation source corresponds to the playback position. The Response parameter enables you to set the speed of the response to the modulation source.

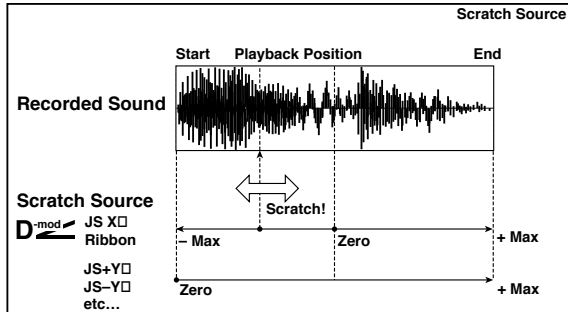

c: Envelope Select

c: Src

d: Threshold

When “Envelope Select” is set to D-mod, the input signal will be recorded only when the modulation source value is 64 or higher.

When “Envelope Select” is set to Input, the input signal will be recorded only when its level is over the Threshold value.

The maximum recording time is 2,730msec. If this is exceeded, the recorded data will start being erased from the top.

e: Response

This parameter enables you to set the speed of the response to the end of recording. Set a smaller value when you are recording a phrase or rhythm pattern, and set a higher value if you are recording only one note.

f: Direct Mix

With Always On, a dry sound is usually output. With Always Off, dry sounds are not output. With Cross Fade, a dry sound is usually output, and it is muted only when scratching.

Set Wet/Dry to 100 to use this parameter effectively.

44: Grain Shifter

This effect cuts extremely short samples (“grains”) from the input signal waveform and plays them repeatedly, giving a mechanical character to the sound.

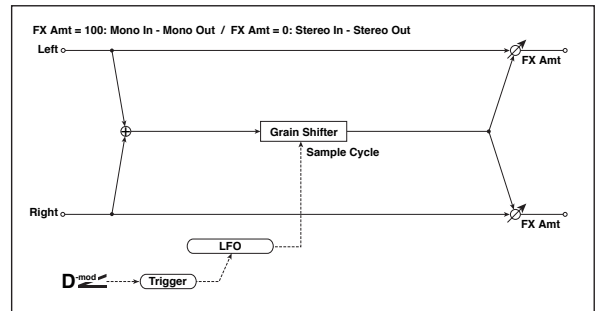

a	Duration	0...100	Sets the duration of the grain	
	Src	Off...Tempo	Selects the source that will modulate the duration of the grain	
	Amt	-100...+100	Sets the amount by which the grain duration will be modulated	
b	LFO Sync Src	Off...Tempo	Selects the modulation source that will reset the LFO	
	LFO Sample Cycle [Hz]	0.02...20.00	Sets the frequency at which the grain will be switched	
c	Src	Off...Tempo	Selects a modulation source for LFO speed	
	Amt	-20.00...+20.00	Sets the modulation amount of LFO speed	
d	MIDI Sync	Off, On	When this is on, the LFO speed is set by BPM, Base Note, and Times, instead of Frequency	
	BPM	MIDI, 40.00...300.00	MIDI syncs to the system tempo; 40-300 sets the tempo manually for this individual effect	
	Base Note	r...w	Selects the type of notes that specify the LFO speed	
	Times	x1...x32	Sets the number of notes that specify the LFO speed	
e	Wet/Dry	Dry, 1:99...99:1, Wet	Balance between the wet and dry signal	
	Src	Off...Tempo	Table, “Dynamic Modulation sources,” on page 357	
	Amt	-100...+100	Amount of modulation source	

a: Duration

c: LFO Sample Cycle [Hz]

Duration sets the length of the sampled grain, and the **LFO Sample Cycle** controls how often a new grain is sampled. In between Sample Cycles, the current grain is repeated continuously.

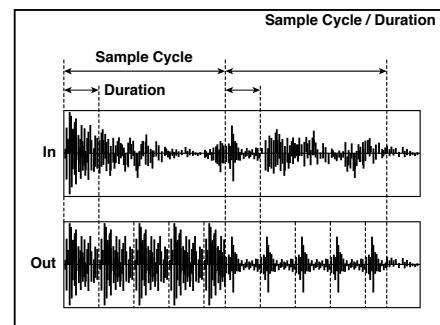

45: Stereo Tremolo

This effect modulates the volume level of the input signal. The effect is stereo, and offsetting the LFO of the left and right phases from each other produces a tremolo effect between left and right.

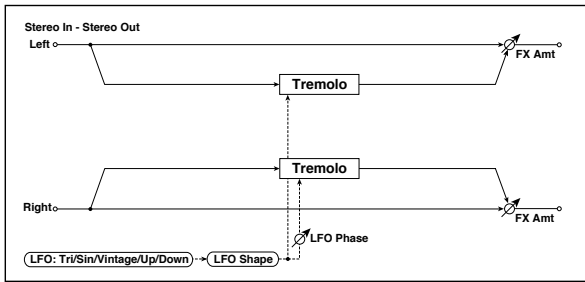

a	LFO Waveform	Triangle, Sine, Vintage, Up, Down	Selects the LFO Waveform	
	LFO Shape	-100...+100	Changes the curvature of the LFO Waveform	
b	LFO Phase [degree]	-180...+180	Sets the LFO phase difference between the left and right	
c	LFO Frequency [Hz]	0.02...20.00	Sets the speed of the LFO	
	Src	Off...Tempo	Selects a modulation source for LFO speed	
d	Amt	-20.00...+20.00	Sets the modulation amount of LFO speed	
	MIDI Sync	Off, On	When this is on, the LFO speed is set by BPM, Base Note, and Times, instead of Frequency	
	BPM	MIDI, 40.00...300.00	MIDI syncs to the system tempo; 40-300 sets the tempo manually for this individual effect	
	Base Note	r...w	Selects the type of notes that specify the LFO speed	
e	Times	x1...x32	Sets the number of notes that specify the LFO speed	
	Depth	0...100	Sets the depth of LFO modulation	
	Src	Off...Tempo	Selects the modulation source of the depth of modulation	
f	Amt	-100...+100	Sets the modulation amount of the depth of modulation	
	Wet/Dry	Dry, 1:99...99:1, Wet	Balance between the wet and dry signal	
	Src	Off...Tempo	Table, "Dynamic Modulation sources," on page 357	
	Amt	-100...+100	Amount of modulation source	

a: LFO Waveform

This parameter sets the basic shape of the LFO. The **Vintage** waveform models classic guitar-amp tremolo.

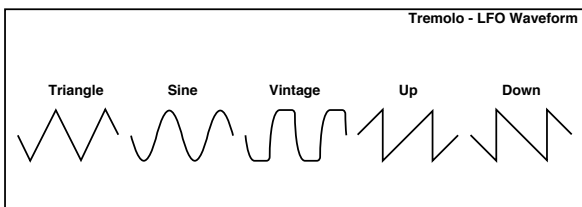

b: LFO Phase [degree]

This parameter determines the difference between the left and right LFO phases. A higher value will simulate the auto-pan effect in which the sound is panned between left and right.

46: St. Env. Tremolo (Stereo Envelope Tremolo)

This effect uses the input signal level to modulate a stereo tremolo (LFO volume modulation). For instance, you can create a tremolo effect that becomes deeper and faster as the input gets more quiet.

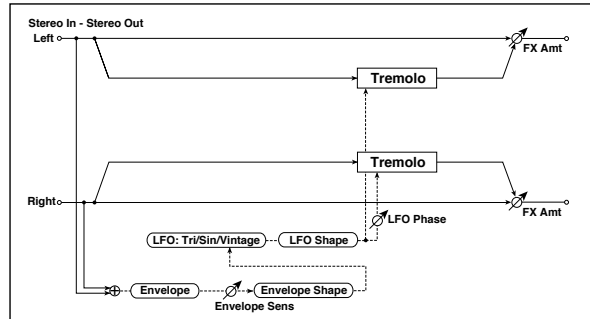

a	Envelope Sens	0...100	Sets the envelope's sensitivity to the input signal	
	Envelope Shape	-100...+100	Sets the envelope's curvature	
b	LFO Waveform	Triangle, Sine, Vintage	Selects the LFO Waveform	
	LFO Shape	-100...+100	Changes the curvature of the LFO Waveform	
c	LFO Phase [degree]	-180...+180	Sets the LFO phase difference between the left and right	
d	LFO Frequency [Hz]	0.02...20.00	Sets the speed of the LFO	
e	Envelope Amount [Hz]	-20.00...+20.00	Sets the amount added to or subtracted from the Frequency when the envelope is at maximum	
	Depth	0...100	Sets the initial amount of tremolo	
f	Envelope Amount	-100...+100	Sets the amount added to or subtracted from the Depth when the envelope is at maximum	
	Wet/Dry	Dry, 1:99...99:1, Wet	Balance between the wet and dry signal	
	Src	Off...Tempo	Table, "Dynamic Modulation sources," on page 357	
	Amt	-100...+100	Amount of modulation source	

d: LFO Frequency [Hz]

d: Envelope Amount [Hz]

e: Depth

e: Envelope Amount

The graphic below shows an example of tremolo modulation with negative modulation of both **Depth** and **Frequency**. At the start of the note, the input is at maximum volume. This slows down the LFO **Frequency** to **1.0Hz**, but also modulates the **Depth** to **0**—so the tremolo doesn't have any effect.

As the input volume dies down, the **Frequency** speeds up; the **Depth** also increases, making the tremolo effect increasingly audible. When the input volume approaches silence, the **Depth** is at its maximum (**100**) and **Frequency** is at **8Hz**.

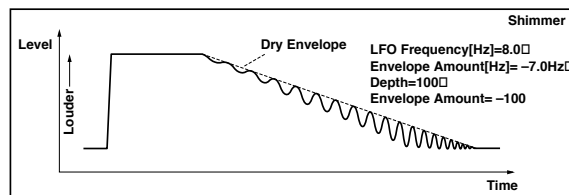

47: Stereo Auto Pan

This is a stereo-in, stereo-out auto-panner. The Phase and Shape parameters lets you create various panning effects, such as making the left and right inputs seem to chase each other around the stereo field.

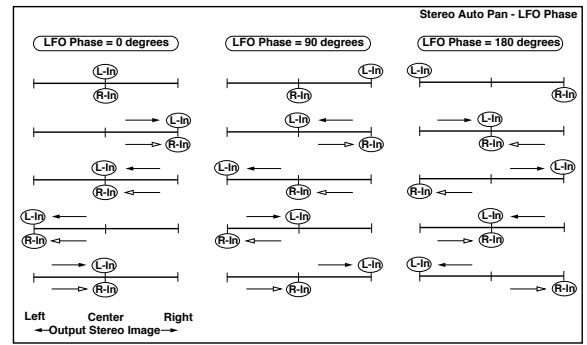
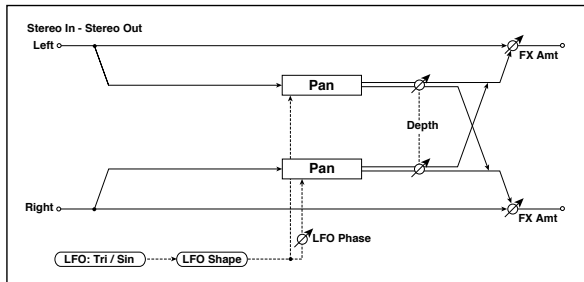

a	LFO Waveform	Triangle, Sine	Selects the LFO Waveform	
	LFO Shape	-100...+100	Changes the curvature of the LFO Waveform	
b	LFO Phase [degree]	-180...+180	Sets the LFO phase difference between the left and right	
c	LFO Frequency [Hz]	0.02...20.00	Sets the speed of the LFO	
	Src	Off...Tempo	Selects a modulation source for LFO speed	
	Amt	-20.00...+20.00	Sets the modulation amount of LFO speed	
	MIDI Sync	Off, On	When this is on, the LFO speed is set by BPM, Base Note, and Times, instead of Frequency	
d	BPM	MIDI, 40.00...300.00	MIDI syncs to the system tempo; 40-300 sets the tempo manually for this individual effect	
	Base Note	r...w	Selects the type of notes that specify the LFO speed	
	Times	x1...x32	Sets the number of notes that specify the LFO speed	
e	Depth	0...100	Sets the depth of LFO modulation	
	Src	Off...Tempo	Selects the modulation source of the depth of modulation	
f	Amt	-100...+100	Sets the modulation amount of the depth of modulation	
	Wet/Dry	Dry, 1:99...99:1, Wet	Balance between the wet and dry signal	
	Src	Off...Tempo	Table, "Dynamic Modulation sources," on page 357	
	Amt	-100...+100	Amount of modulation source	

a: LFO Shape

You can change the panning by modifying the LFO's Shape.

b: LFO Phase [degree]

This determines the phase difference between the left and right LFOs. When you gradually change the value away from 0, the sounds from the left and right channels will seem to chase each other around. If you set the parameter to +180 or -180, the sounds from each channel will cross over each other.

You'll only hear the effect of this parameter if the input is true stereo, with different signals in the left and right channels.

48: St. Phaser + Trml (Stereo Phaser + Tremolo)

This effect combines a stereo phaser and tremolo, with linked LFOs. Swelling phaser modulation and tremolo effects synchronize with each other, creating a soothing modulation effect particularly suitable for electric piano.

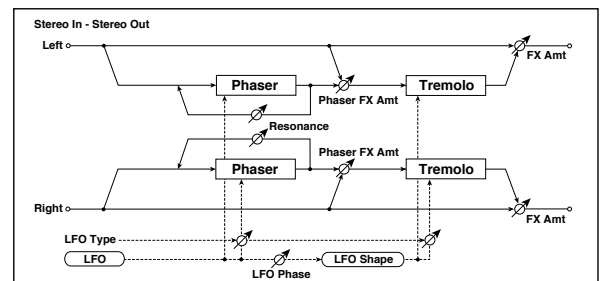

a	Type	Phs - Trml, ... Phs LR - Trml LR	Selects the type of the tremolo and phaser LFOs	
	LFO Phase [degree]	-180...+180	Sets the phase difference between the tremolo and phaser LFOs	
b	LFO Frequency [Hz]	0.02...20.00	Sets the speed of the LFO	
	Src	Off...Tempo	Selects a modulation source for LFO speed	
	Amt	-20.00...+20.00	Sets the LFO speed modulation amount	
	MIDI Sync	Off, On	When this is on, the LFO speed is set by BPM, Base Note, and Times, instead of Frequency	
c	BPM	MIDI, 40.00...300.00	MIDI syncs to the system tempo; 40-300 sets the tempo manually for this individual effect	
	Base Note	r...w	Selects the type of notes that specify the LFO speed	
	Times	x1...x32	Sets the number of notes that specify the LFO speed	
d	Phaser Manual	0...100	Sets the phaser frequency range	
	Resonance	-100...+100	Sets the phaser resonance amount	
e	Phaser Depth	0...100	Sets the phaser modulation depth	
	Src	Off...Tempo	Selects the modulation source for the phaser modulation depth	
	Amt	-100...+100	Sets the modulation amount for the phaser modulation depth	
f	Phaser Wet/Dry	-Wet, -2 : 98...Dry... 2 : 98, Wet	Sets the balance between the phaser effect and dry sounds	
g	Tremolo Shape	-100...+100	Sets the degree of the tremolo LFO shaping	
h	Tremolo Depth	0...100	Sets the tremolo modulation depth	
	Src	Off...Tempo	Selects the modulation source for the tremolo modulation depth	
	Amt	-100...+100	Sets the modulation amount of the tremolo modulation depth	

i	Wet/Dry	Dry, 1:99...99:1, Wet	Balance between the wet and dry signal	
	Src	Off...Tempo	Table, "Dynamic Modulation sources," on page 357	
	Amt	-100...+100	Amount of modulation source	

a: Type

a: LFO Phase [degree]

Select the type of phaser LFO and tremolo LFO for the "Type" parameter. How the effect sound moves or rotates depends on the type of LFO. Selecting "LFO Phase" enables you to offset the timing of the phaser peak and control a subtle movement and rotation of the sound.

f: Phaser Wet/Dry

i: Wet/Dry

PHASER Wet/Dry sets the balance between the phaser output and the dry sound. **OUTPUT Wet/Dry** sets the balance between the final phaser and tremolo output level and the dry sound.

49: St. Ring Modulator (Stereo Ring Modulator)

This effect creates a metallic sound by applying the oscillators to the input signal. Use the LFO or Dynamic Modulation to modulate the oscillator to create a radical modulation. Matching the oscillator frequency with a note number will produce a ring modulation effect in specific key ranges.

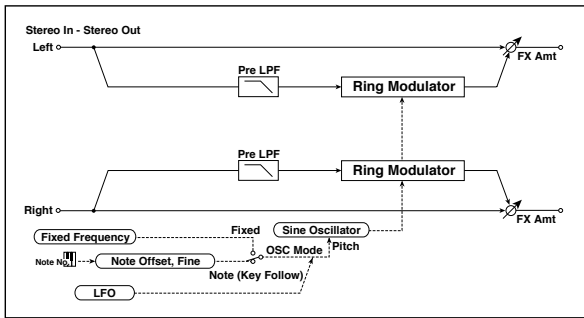

a	OSC Mode	Fixed, Note (Key Follow)	Switching between specifying the oscillator frequency and using a note number	
	Pre LPF	0...100	Sets the damping amount of the high range input to the ring modulator	
b	Fixed Frequency [Hz]	0...12.00k	Sets the oscillator frequency when OSC Mode is set to Fixed	
	Src	Off...Tempo	Selects the modulation source for the oscillator frequency when OSC Mode is set to Fixed	
	Amt	-12.00k...+12.00k	Sets the modulation amount of the oscillator frequency when OSC Mode is set to Fixed	
c	Note Offset	-48...+48	Sets the pitch difference from the original note when OSC Mode is set to Note (Key Follow)	
	Note Fine	-100...+100	Fine-adjusts the oscillator frequency	
d	LFO Frequency [Hz]	0.02...20.00	Sets the speed of the LFO	
	Src	Off...Tempo	Selects a modulation source for LFO speed	
	Amt	-20.00...+20.00	Sets the modulation amount of LFO speed	

e	MIDI Sync	Off, On	When this is on, the LFO speed is set by BPM, Base Note, and Times, instead of Frequency	
	BPM	MIDI, 40.00...300.00	MIDI syncs to the system tempo; 40-300 sets the tempo manually for this individual effect	
	Base Note	r...w	Selects the type of notes that specify the LFO speed	
	Times	x1...x32	Sets the number of notes that specify the LFO speed	
f	LFO Depth	0...100	Sets the depth of LFO modulation for the oscillator frequency	
	Src	Off...Tempo	Selects the modulation source of the depth of modulation	
	Amt	-100...+100	Sets the modulation amount of the depth of modulation	
g	Wet/Dry	Dry, 1:99...99:1, Wet	Balance between the wet and dry signal	
	Src	Off...Tempo	Table, "Dynamic Modulation sources," on page 357	
	Amt	-100...+100	Amount of modulation source	

a: OSC Mode

This parameter determines whether or not the oscillator frequency follows the note number.

a: Pre LPF

This parameter enables you to set the damping amount of the high range sound input to the ring modulator. If the input sound contains lots of harmonics, the effect may sound dirty. In this case, cut a certain amount of high range.

b: Fixed Frequency [Hz]

This parameter sets the oscillator frequency when "OSC Mode" is set to Fixed.

c: Note Offset

c: Note Fine

These parameters for the oscillator are used when "OSC Mode" is set to Note (Key Follow). The "Note Offset" sets the pitch difference from the original note in semitone steps. The "Note Fine" parameter fine-adjusts the pitch in cent steps. Matching the oscillator frequency with the note number produces a ring modulation effect in the correct key.

50: Detune

Using this effect, you can obtain a detune effect that offsets the pitch of the effect sound slightly from the pitch of the input signal. Compared to the chorus effect, a more natural sound thickness will be created.

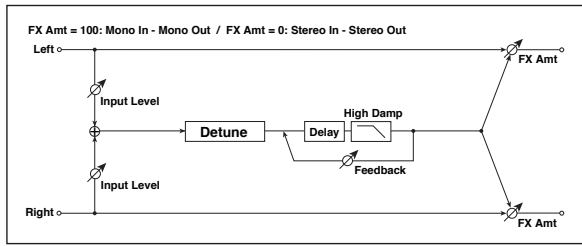

a	Pitch Shift [cents]	-100...+100	Sets the pitch difference from the input signal
	Src	Off...Tempo	Selects a modulation source for pitch shift
	Amt	-100...+100	Sets the modulation amount for pitch shift
b	Delay Time [msec]	0...1000	Sets the delay time
c	Feedback	-100...+100	Sets the feedback amount
	High Damp [%]	0...100	Sets the damping amount in the high range
d	Input Level Dmod [%]	-100...+100	Sets the modulation amount of the input level
	Src	Off...Tempo	Selects the modulation source for the input level
e	Wet/Dry	Dry, 1:99...99:1, Wet	Balance between the wet and dry signal
	Src	Off...Tempo	Table, "Dynamic Modulation sources," on page 357
	Amt	-100...+100	Amount of modulation source

d: Input Level Dmod [%]

d: Src

This parameter sets the dynamic modulation of the input level.

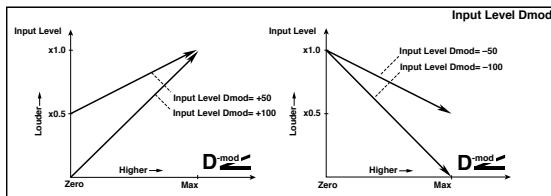

51: Pitch Shifter

This effect changes the pitch of the input signal. You can select from three types: Fast (quick response), Medium, and Slow (preserves tonal quality). You can also create an effect in which the pitch is gradually raised (or dropped) using the delay with feedback.

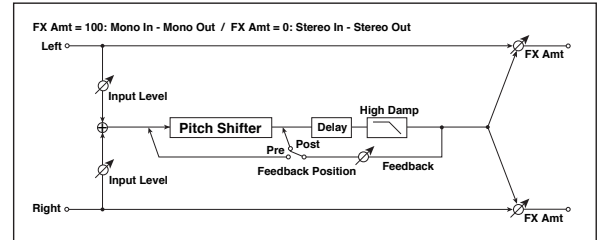

a	Mode	Slow, Medium, Fast	Switches Pitch Shifter mode
b	Pitch Shift [1/2tone]	-24...+24	Sets the pitch shift amount by steps of a semitone
	Src	Off...Tempo	Selects the modulation source of pitch shift amount
	Amt	-24...+24	Sets the modulation amount of pitch shift amount
c	Fine [cents]	-100...+100	Sets the pitch shift amount by steps of a cent
	Amt	-100...+100	Sets the modulation amount of pitch shift amount
d	Delay Time [msec]	0...2000	Sets the delay time
e	Feedback Position	Pre, Post	Switches the feedback connection
f	Feedback	-100...+100	Sets the feedback amount
	High Damp [%]	0...100	Sets the damping amount in the high range
g	Input Level Dmod [%]	-100...+100	Sets the modulation amount of the input level
	Src	Off...Tempo	Selects the modulation source for the input level
h	Wet/Dry	Dry, 1:99...99:1, Wet	Balance between the wet and dry signal
	Src	Off...Tempo	Table, "Dynamic Modulation sources," on page 357
	Amt	-100...+100	Amount of modulation source

a: Mode

This parameter switches the pitch shifter operating mode. With Slow, tonal quality will not be changed too much. With Fast, the effect becomes a Pitch Shifter that has a quick response, but may change the tone. Medium is in-between these two. If you do not need to set too much pitch shift amount, set this parameter to Slow. If you wish to change the pitch significantly, use Fast.

b: Pitch Shift [1/2tone]

b: Src

b: Amt

c: Fine [cents]

c: Amt

The amount of pitch shift will use the value of the **Pitch Shift** plus the **Fine** value. The amount of modulation will use the b: Amt value plus the c: Amt.

The same Modulation Source is used for both **Pitch Shift** and **Fine**.

e: Feedback Position

f: Feedback

When **Feedback Position** is set to **Pre**, the pitch shifter output is again input to the pitch shifter. Therefore, if you specify a higher

value for the Feedback parameter, the pitch will be raised (or lowered) more and more each time feedback is repeated.

If **Feedback Position** is set to **Post**, the feedback signal will not pass through the pitch shifter again. Even if you specify a higher value for the **Feedback** parameter, the pitch-shifted sound will be repeated at the same pitch.

52: Pitch Shifter BPM

This pitch shifter enables you to set the delay time to match the song tempo.

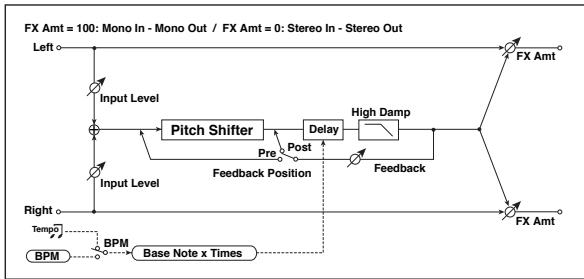

a	Mode	Slow, Medium, Fast	Switches Pitch Shifter mode	
b	Pitch Shift [1/2tone]	-24...+24	Sets the pitch shift amount in steps of a semitone	
	Src	Off...Tempo	Selects the modulation source of pitch shift amount	
	Amt	-24...+24	Sets the modulation amount of pitch shift amount	
c	Fine [cents]	-100...+100	Sets the pitch shift amount in steps of one cent	
	Amt	-100...+100	Sets the modulation amount of pitch shift amount	
d	BPM	MIDI, 40.00...300.00	MIDI syncs to the system tempo; 40-300 sets the tempo manually for this individual effect	
	Time Over?	--, OVER!	Displays an error message when the delay time exceeds the upper limit	
e	Delay Base Note	r...w	Selects the type of notes to specify the delay time	
	Times	x1...x32	Sets the number of notes to specify the delay time	
f	Feedback Position	Pre, Post	Switches the feedback connection	
g	Feedback	-100...+100	Sets the feedback amount	
	High Damp [%]	0...100	Sets the damping amount in the high range	
h	Input Level Dmod [%]	-100...+100	Sets the modulation amount of the input level	
	Src	Off...Tempo	Selects the modulation source for the input level	
i	Wet/Dry	Dry, 1:99...99:1, Wet	Balance between the wet and dry signal	
	Src	Off...Tempo	Table, "Dynamic Modulation sources," on page 357	
	Amt	-100...+100	Amount of modulation source	

d: BPM

e: Delay Base Note

e: Times

The delay time is the duration of "Times" number of "Delay Base Note" note values at the "BPM" tempo (or if "BPM" is set to MIDI, the tempo determined by MIDI Clock).

d: Time Over?

You can set the delay time up to 5,290msec. If the delay time exceeds this limit, the error message "OVER!" appears on the display. Set the delay time parameters so that this message will not appear. "Time Over?" is only a display parameter.

53: Pitch Shift Mod. (Pitch Shift Modulation)

This effect modulates the detuned pitch shift amount using an LFO, adding a clear spread and width to the sound by panning the effect sound and dry sound to the left and right. This is especially effective when the effect sound and dry sound output from stereo speakers are mixed.

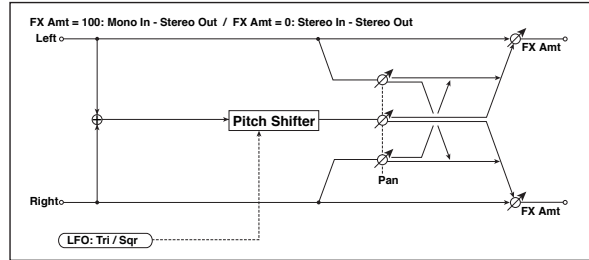

a	Pitch Shift [cents]	-100...+100	Sets the pitch difference from the input signal	
b	LFO Waveform	Triangle, Square	Selects the LFO Waveform	
c	LFO Frequency [Hz]	0.02...20.00	Sets the speed of the LFO	
	Src	Off...Tempo	Selects a modulation source for LFO speed	
	Amt	-20.00...+20.00	Sets the modulation amount of LFO speed	
d	MIDI Sync	Off, On	When this is on, the LFO speed is set by BPM, Base Note, and Times, instead of Frequency	
	BPM	MIDI, 40.00...300.00	MIDI syncs to the system tempo; 40-300 sets the tempo manually for this individual effect	
	Base Note	r...w	Selects the type of notes that specify the LFO speed	
	Times	x1...x32	Sets the number of notes that specify the LFO speed	
e	Depth	-100...+100	Sets the LFO modulation depth for pitch shift amount	
	Src	Off...Tempo	Selects the modulation source of the depth of modulation	
f	Amt	-100...+100	Sets the modulation amount of the depth of modulation	
	Pan	L, 1:99...99:1, R	Sets the panning effect sound and dry sound separately	
g	Wet/Dry	Dry, 1:99...99:1, Wet	Balance between the wet and dry signal	
	Src	Off...Tempo	Table, "Dynamic Modulation sources," on page 357	
	Amt	-100...+100	Amount of modulation source	

a: Pitch Shift [cents]

e: Depth

These parameters set the amount of pitch shift and amount of modulation by means of the LFO.

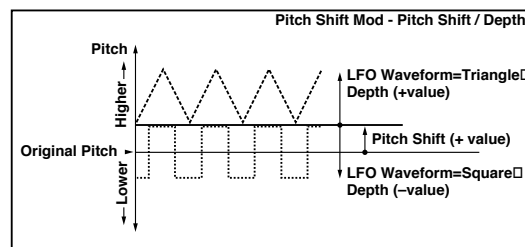

g: Pan

h: Wet/Dry

The Pan parameter pans the effect sound and dry sound to the left and right. With L, the effect sound is panned left, and the dry sound is panned right. With a Wet/Dry = Wet setting, the effect and dry sound will be output in a proportion of 1:1.

54: Organ Vib/Chorus (Organ Vibrato/Chorus)

This effect simulates the chorus and vibrato circuitry of a vintage organ. The modulation speed and depth can be customized.

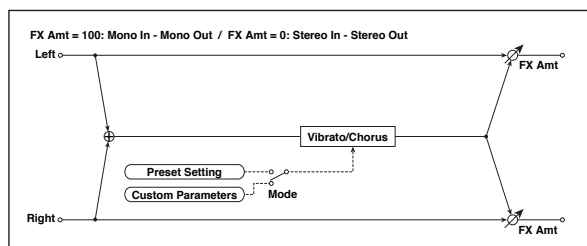

a	Input Trim	0...100	Sets the input level
b	Control Mode	Preset, Custom	Selects either preset or custom settings
c	Preset Type	V1, C1, V2, C2, V3, C3	Selects the effect type when Mode=Preset. V1/V2/V3 are variations of vibrato, and C1/C2/C3 are variations of chorus
	Src	Off...Tempo	Selects the modulation source that will change the effect type
	Amt	-5...+5	Sets the modulation amount for changing the effect type
d	Custom Mix	Vibrato, 1:99...99:1, Chorus	Sets the mix level of the direct sound when Mode=Preset
	Src	Off...Tempo	Selects the modulation source that will control the mix level of the direct sound
	Amt	-100...+100	Sets the modulation amount for controlling the mix level of the direct sound
e	Custom Depth	0...100	Sets the vibrato depth
	Src	Off...Tempo	Selects the modulation source that will control vibrato depth
	Amt	-100...+100	Sets the modulation amount for controlling the vibrato depth
f	Custom Speed [Hz]	0.02...20.00	Sets the vibrato speed
	Src	Off...Tempo	Selects the modulation source for controlling the vibrato speed
	Amt	-20.00...+20.00	Sets the modulation amount for controlling the vibrato speed
g	Wet/Dry	Dry, 1:99...99:1, Wet	Balance between the wet and dry signal
	Src	Off...Tempo	Table, "Dynamic Modulation sources," on page 357
	Amt	-100...+100	Amount of modulation source

b: Control Mode

c: Preset Type

d: Custom Mix

e: Custom Depth

f: Custom Speed [Hz]

If Control Mode=Preset, you can use c: Preset Type to select the effect. In this case, the Custom Mix/Depth/Speed settings are ignored. If Control Mode=Custom, the Custom Mix/Depth/Speed settings are valid, and the c: Preset Type setting is ignored.

c: Amt

If Preset Type=V1 and Src=JS+Y, you can set this to +5 and move JS +Y to control the effect in the order of V1 C1 V2 C2 V3 C3.

55: Rotary Speaker

This effect simulates a rotary speaker, and obtains a more realistic sound by simulating the rotor in the low range and the horn in the high range separately. The effect also simulates the stereo microphone settings.

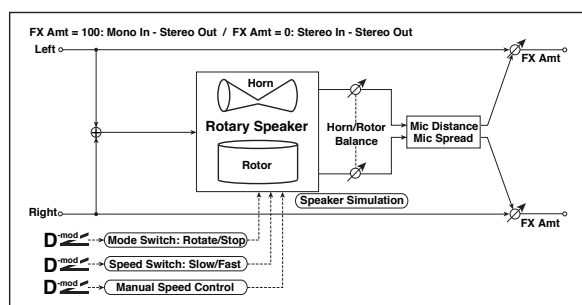

a	Mode Switch	Rotate, Stop	Switches between speaker rotation and stop
	Src	Off...Tempo	Selects a modulation source for Rotate/Stop
	Mode	Toggle, Moment	Sets the switch mode for Rotate/Stop modulation
b	Speed Switch	Slow, Fast	Switches the speaker rotation speed between slow and fast
	Src	Off...Tempo	Selects a modulation source for Slow/Fast
	Mode	Toggle, Moment	Sets the switch mode for Slow/Fast modulation
c	Manual Speed Ctrl	Off...Tempo	Sets a modulation source for direct control of rotation speed
d	Horn Acceleration	0...100	How quickly the horn rotation speed in the high range is switched
	Horn Ratio	Stop, 0.50...2.00	Adjusts the (high-range side) horn rotation speed. Standard value is 1.00. Selecting "Stop" will stop the rotation
e	Rotor Acceleration	0...100	Determines how quickly the rotor rotation speed in the low range is switched
	Rotor Ratio	Stop, 0.50...2.00	Adjusts the (low-frequency) rotor speed. Standard value is 1.00. Selecting "Stop" will stop the rotation
f	Horn/Rotor Balance	Rotor, 1...99, Horn	Sets the level balance between the high-frequency horn and low-frequency rotor
g	Mic Distance	0...100	Sets the distance between the microphone and rotary speaker
	Mic Spread	0...100	Sets the angle of left and right microphones
h	Wet/Dry	Dry, 1:99...99:1, Wet	Balance between the wet and dry signal
	Src	Off...Tempo	Table, "Dynamic Modulation sources," on page 357
	Amt	-100...+100	Amount of modulation source

a: Mode

This parameter sets how the modulation source switches between rotation and stop.

When **Mode = Toggle**, the speaker rotates or stops alternately each time you press the pedal or move the joystick. Via MIDI, rotation will switch between start and stop each time the modulation amount exceeds 64.

When **Mode = Moment**, the speaker rotates by default, and stops only when you press the pedal or move the joystick. Via MIDI, modulation values above 64 make the speaker rotate, and values below 64 make it stop.

b: Speed Switch

This parameter controls how the rotation speed (slow and fast) is switched via the modulation source.

When **Mode = Toggle**, the speed will switch between slow and fast each time you press the pedal or move the joystick. Via MIDI, the speed will switch each time the modulation amount exceeds 64.

When **Mode = Moment**, the speed is usually slow. It becomes fast only when you press the pedal or move the joystick. Via MIDI, modulation values above 64 set the speed to **Fast**, and values below 64 set it to **Slow**.

c: Manual Speed Ctrl

If you wish to control the rotation speed manually, instead of switching between Slow and Fast, select a modulation source in the **Manual Speed Ctrl** parameter. If you don't want to use manual control, set this to **Off**.

d: Horn Acceleration

e: Rotor Acceleration

On a real rotary speaker, the rotation speed accelerates or decelerates gradually after you switch the speed. The **Horn** and **Rotor Acceleration** parameters set the transition times between fast and slow speeds.

g: Mic Distance

g: Mic Spread

This is a simulation of stereo microphone settings.

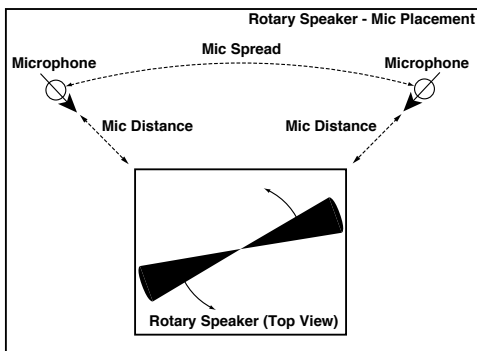

Delay

56: L/C/R Delay

This multitap delay outputs three Tap signals to the left, right, and center respectively. You can also adjust the left and right spread of the delay sound.

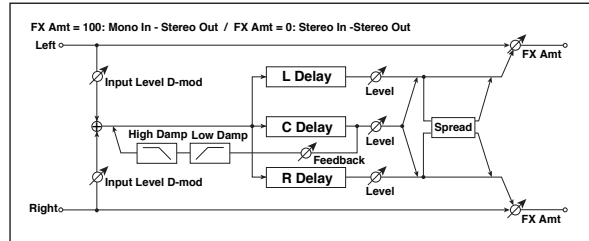

a	L Delay Time [msec]	0...2730	Sets the delay time of TapL	
	Level	0...50	Sets the output level of TapL	
b	C Delay Time [msec]	0...2730	Sets the delay time of TapC	
	Level	0...50	Sets the output level of TapC	
c	R Delay Time [msec]	0...2730	Sets the delay time of TapR	
	Level	0...50	Sets the output level of TapR	
d	Feedback (C Delay)	-100...+100	Sets the feedback amount of TapC	
	Src	Off...Tempo	Selects the modulation source of the TapC feedback amount	
	Amt	-100...+100	Sets the modulation amount of the TapC feedback amount	
e	High Damp [%]	0...100	Sets the damping amount in the high range	
	Low Damp [%]	0...100	Sets the damping amount in the low range	
f	Input Level Dmod [%]	-100...+100	Sets the modulation amount of the input level	
	Src	Off...Tempo	Selects the modulation source for the input level	
g	Spread	0...50	Sets the width of the stereo image of the effect sound	
h	Wet/Dry	Dry, 1:99...99:1, Wet	Balance between the wet and dry signal	
	Src	Off...Tempo	Table, "Dynamic Modulation sources," on page 357	
	Amt	-100...+100	Amount of modulation source	

e: High Damp [%]

e: Low Damp [%]

These parameters set the damping amount of high range and low range. The tone of the delayed sound becomes darker and lighter as it feeds back.

g: Spread

This parameter sets the pan width of the effect sound. The stereo image is widest with a value of 50, and the effect sound of both channels is output from the center with a value of 0.

57: Stereo/CrossDelay

This is a stereo delay, and can be used as a cross-feedback delay effect in which the delay sounds cross over between the left and right by changing the feedback routing.

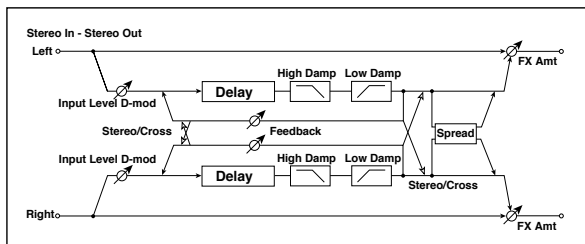

a	Stereo/Cross	Stereo, Cross	Switches between stereo delay and cross-feedback delay	
b	L Delay Time [msec]	0.0...1360.0	Sets the delay time for the left channel	
c	R Delay Time [msec]	0.0...1360.0	Sets the delay time for the right channel	
d	L Feedback	-100...+100	Sets the feedback amount for the left channel	
	Src	Off...Tempo	Selects the modulation source of feedback amount	
	Amt L	-100...+100	Sets the modulation amount of the left channel feedback	
e	R Feedback	-100...+100	Sets the feedback amount for the right channel	
	Amt R	-100...+100	Sets the modulation amount of the right channel feedback	
f	High Damp [%]	0...100	Sets the damping amount in the high range	
g	Low Damp [%]	0...100	Sets the damping amount in the low range	
h	Input Level Dmod [%]	-100...+100	Sets the modulation amount of the input level	
	Src	Off...Tempo	Selects the modulation source for the input level	
i	Spread	-50...+50	Sets the width of the stereo image of the effect sound	
j	Wet/Dry	Dry, 1:99...99:1, Wet	Balance between the wet and dry signal	
	Src	Off...Tempo	Table, "Dynamic Modulation sources," on page 357	
	Amt	-100...+100	Amount of modulation source	

58: St. Multitap Delay (Stereo Multitap Delay)

The left and right Multitap Delays have two taps respectively. Changing the routing of feedback and tap output allows you to create various patterns of complex effect sounds.

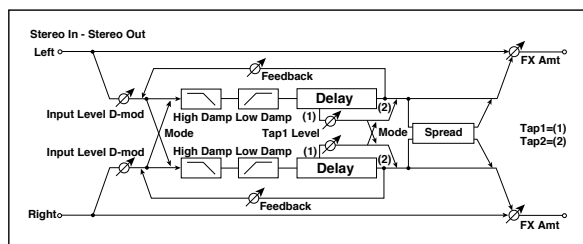

a	Mode	Normal, Cross Feedback, Cross Pan1, Cross Pan2	Switches the left and right delay routing	
b	Tap1 Time [msec]	0.0...1360.0	Sets the Tap1 delay time	
c	Tap2 Time [msec]	0.0...1360.0	Sets the Tap2 delay time	
d	Tap1 Level	0...100	Sets the Tap1 output level	
e	Feedback (Tap2)	-100...+100	Sets the Tap2 feedback amount	
	Src	Off...Tempo	Selects the modulation source of the Tap2 feedback amount	
	Amt	-100...+100	Sets the modulation amount of the Tap2 feedback amount	
f	High Damp [%]	0...100	Sets the damping amount in the high range	
g	Low Damp [%]	0...100	Sets the damping amount in the low range	
h	Input Level Dmod [%]	-100...+100	Sets the modulation amount of the input level	
	Src	Off...Tempo	Selects the modulation source for the input level	
i	Spread	-100...+100	Sets the width of the stereo image of the effect sound	
	Src	Off...Tempo	Selects the modulation source of the effect sound's stereo image width	
	Amt	-100...+100	Sets the modulation amount of the effect sound's stereo image width	
j	Wet/Dry	Dry, 1:99...99:1, Wet	Balance between the wet and dry signal	
	Src	Off...Tempo	Table, "Dynamic Modulation sources," on page 357	
	Amt	-100...+100	Amount of modulation source	

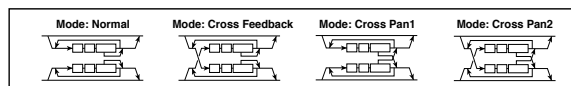

a: Mode

You can change how the left and right delay signals are panned by modifying the routing of the left and right delay as shown in the figure above. You need to input different sounds to each channel in order for this parameter to be effective.

d: Tap1 Level

This parameter sets the output level of Tap1. Setting a different level from Tap2 will add a unique touch to a monotonous delay and feedback.

59: St. Mod Delay (Stereo Modulation Delay)

This stereo delay uses an LFO to sweep the delay time. The pitch also varies, creating a delay sound which swells and shimmers. You can also control the delay time using a modulation source.

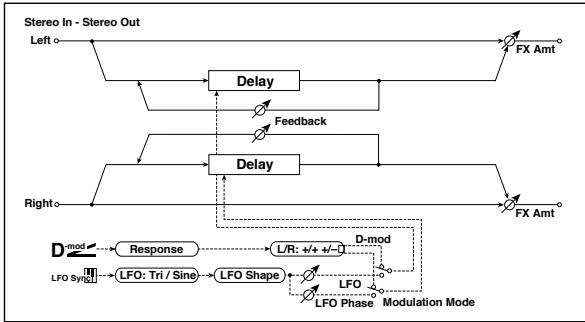

a	Modulation Mode	LFO, D-mod	Switches between LFO modulation control and modulation source control	
b	D-mod Modulation	L/R: +/+ , L/R: +/-	Reversed L/R control by modulation source	
	Src	Off...Tempo	Selects the modulation source that controls delay time	
c	Response	0...30	Sets the rate of response to the modulation source	
	LFO Waveform	Triangle, Sine	Selects the LFO Waveform	
d	LFO Shape	-100...+100	Changes the curvature of the LFO Waveform	
	LFO Sync	Off, On	Switches LFO reset off/on	
e	Src	Off...Tempo	Selects the modulation source that resets the LFO	
	LFO Frequency [Hz]	0.02...20.00	Sets the speed of the LFO	
f	MIDI Sync	Off, On	When this is on, the LFO speed is set by BPM, Base Note, and Times, instead of Frequency	
	BPM	MIDI, 40.00...300.00	MIDI syncs to the system tempo; 40-300 sets the tempo manually for this individual effect	
	Base Note	r...w	Selects the type of notes that specify the LFO speed	
	Times	x1...x32	Sets the number of notes that specify the LFO speed	
g	L LFO Phase [deg]	-180...+180	Sets the phase obtained when the left LFO is reset	
	L Depth	0...200	Sets the depth of the left LFO modulation	
h	R LFO Phase [deg]	-180...+180	Sets the phase obtained when the right LFO is reset	
	R Depth	0...200	Sets the depth of the right LFO modulation	
i	L Delay Time [msec]	0.0...1000.0	Sets the delay time for the left channel	
	L Feedback	-100...+100	Sets the feedback amount of left delay	
j	R Delay Time [msec]	0.0...1000.0	Sets the delay time for the right channel	
	R Feedback	-100...+100	Sets the feedback amount of right delay	
k	Wet/Dry	-Wet, -1:99...Dry...99:1, Wet	Balance between the wet and dry signal	
	Src	Off...Tempo	Table, "Dynamic Modulation sources," on page 357	
	Amt	-100...+100	Amount of modulation source	

b: D-mod Modulation

When the modulation source is used for control, this parameter reverses the left and right modulation direction.

d: LFO Sync
d: Src
g: L LFO Phase [deg]
h: R LFO Phase [deg]

If "LFO Sync" is On, the LFO will be reset by the modulation source that is received.

The "Src" parameter sets the modulation source that resets the LFO. For example, you can assign Gate as a modulation source so that the sweep always starts from the specified point.

"L LFO Phase" and "R LFO Phase" set the phase obtained when the left and right LFOs are reset. In this way, you can create changes in pitch sweep for the left and right channels individually.

MIDI The effect is off when a value of the modulation source specified in the "Src" parameter is 63 or smaller, and the effect is on when the value is 64 or higher. The LFO is triggered and reset to the "L LFO Phase" and "R LFO Phase" settings when the value changes from 63 or smaller to 64 or higher.

60: St. Dynamic Delay (Stereo Dynamic Delay)

This stereo delay controls the level of delay according to the input signal level. You can use this as a ducking delay that applies delay to the sound only when you play keys at a high velocity or only when the volume level is low.

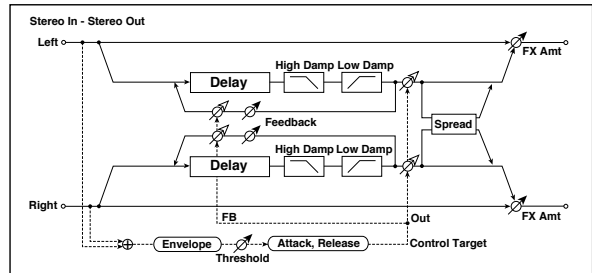

a	Control Target	None, Out, FB	Selects from no control, output, and feedback	
	Polarity	+, -	Reverses level control	
b	Threshold	0...100	Sets the level to which the effect is applied	
	Offset	0...100	Sets the offset of level control	
c	Attack	1...100	Sets the attack time of level control	
d	Release	1...100	Sets the release time of level control	
e	L Delay Time [msec]	0.0...1360.0	Sets the delay time for the left channel	
f	R Delay Time [msec]	0.0...1360.0	Sets the delay time for the right channel	
g	Feedback	-100...+100	Sets the feedback amount	
h	High Damp [%]	0...100	Sets the damping amount in the high range	
	Low Damp [%]	0...100	Sets the damping amount in the low range	
i	Spread	-100...+100	Sets the width of the stereo image of the effect sound	
j	Wet/Dry	Dry, 1:99...99:1, Wet	Balance between the wet and dry signal	
	Src	Off...Tempo	Table, "Dynamic Modulation sources," on page 357	
	Amt	-100...+100	Amount of modulation source	

a: Control Target

This parameter selects no level control, delay output control (effect balance), or feedback amount control.

a: Polarity

b: Threshold

b: Offset

c: Attack

d: Release

The “Offset” parameter specifies the value for the “Control Target” parameter (that is set to None), expressed as the ratio relative to the parameter value (the “Wet/Dry” value with “Control Target”=Output level, or the “Feedback” value with “Control Target”=Feedback).

When “Polarity” is positive, the “Control Target” value is obtained by multiplying the parameter value by the “Offset” value (if the input level is below the threshold), or equals the parameter value if the input level exceeds the threshold.

When “Polarity” is negative, Control Target value equals the parameter value if the input level is below the threshold, or is obtained by multiplying the parameter value by the “Offset” value if the level exceeds the threshold.

The “Attack” and “Release” parameters specify attack time and release time of delay level control.

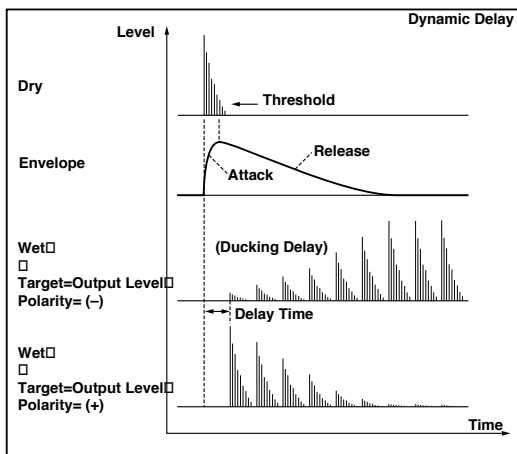

61: St. AutoPanningDly
(Stereo Auto Panning Delay)

This stereo delay effect pans the delay sound left and right using the LFO.

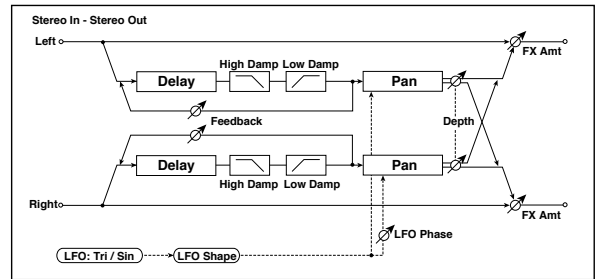

a	L Delay Time [msec]	0.0...1360.0	Sets the delay time for the left channel	
	L Feedback	-100...+100	Sets the feedback amount for the left channel	
b	R Delay Time [msec]	0.0...1360.0	Sets the delay time for the right channel	
	R Feedback	-100...+100	Sets the feedback amount for the right channel	
c	High Damp [%]	0...100	Sets the damping amount in the high range	
	Low Damp [%]	0...100	Sets the damping amount in the low range	
d	LFO Waveform	Triangle, Sine	Selects the LFO Waveform	
	LFO Shape	-100...+100	Changes the curvature of the LFO Waveform	
e	Phase [degree]	-180...+180	Sets the LFO phase difference between the left and right	
f	Panning Freq [Hz]	0.02...20.00	Sets the panning speed	
g	MIDI Sync	Off, On	Switches between using the frequency of the panning speed and using the tempo and notes	
	BPM	MIDI, 40.00...300.00	MIDI syncs to the system tempo; 40-300 sets the tempo manually for this individual effect	
	Base Note	r...w	Selects the type of notes to specify the delay time for the panning speed	
	Times	x1...x32	Sets the number of notes to specify the delay time for the panning speed	
h	Panning Depth	0...100	Sets the panning width	
	Src	Off...Tempo	Selects the modulation source for the panning width	
	Amt	-100...+100	Set the modulation amount of the panning width	
i	Wet/Dry	Dry, 1:99...99:1, Wet	Balance between the wet and dry signal	
	Src	Off...Tempo	Table, “Dynamic Modulation sources,” on page 357	
	Amt	-100...+100	Amount of modulation source	

62: Tape Echo

This effect simulates a tape echo unit with three playback heads. The distortion and tonal change typical of magnetic tape are also reproduced.

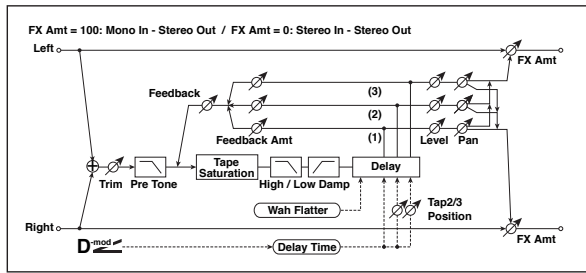

a	Delay (Tap1) [msec]	0...2700	Sets the delay time (tap1)
	Src	Off...Tempo	Selects the modulation source of the delay time
	Amt	-2700...+2700	Sets the modulation amount of delay time
b	Tap2 Position [%]	0...100	Sets the position of Tap 2 relative to the Tap 1 delay time the depth of pitch variation
c	Tap3 Position [%]	0...100	Sets the position of Tap 3 relative to the Tap 1 delay time the depth of pitch variation
d	Tap1 Level	0...100	Sets the Tap1 output level
	Pan	L, 1...99, R	Sets the stereo image of tap1
e	FB Amt	-100...+100	Sets the Tap1 feedback amount
	Tap2 Level	0...100	Sets the Tap2 output level
	Pan	L, 1...99, R	Sets the stereo image of tap2
f	FB Amt	-100...+100	Sets the Tap2 feedback amount
	Tap3 Level	0...100	Sets the Tap3 output level
g	Pan	L, 1...99, R	Sets the stereo image of tap3
	FB Amt	-100...+100	Sets the Tap3 feedback amount
h	Feedback	0...100	Sets the amount of feedback for Taps 1, 2, and 3
	Src	Off...Tempo	Selects the modulation source of feedback amount
i	Amt	-100...+100	Sets the feedback amount
	High Damp [%]	0...100	Sets the damping amount in the high range
j	Low Damp [%]	0...100	Sets the damping amount in the low range
	Saturation	0...100	Sets the distortion amount
k	Input Trim	0...100	Sets the input gain
	Pre Tone	0...100	Sets the tone of the input
l	Wow Flutter [Hz]	0.02...1.00	Sets the frequency at which pitch variation will occur
	Wow Flutter depth	0...100	Sets the depth of pitch variation
m	Wet/Dry	Dry, 1:99...99:1, Wet	Balance between the wet and dry signal
	Src	Off...Tempo	Table, "Dynamic Modulation sources," on page 357
	Amt	-100...+100	Amount of modulation source

a: Delay (Tap1) [msec]

a: Src

a: Amt

b: Tap2 Position [%]

b: Tap3 Position [%]

The delay time for Tap 2 and 3 is specified as a proportion (%) relative to "Delay (Tap1)." Even if you use dynamic modulation to control "Delay (Tap1)," Tap 2 and 3 will change at the same proportion.

d: FB Amt

e: FB Amt

f: FB Amt

g: Feedback

The feedback output from Tap 1, 2, and 3 is mixed according to the "FB Amt," and then the final amount of feedback is specified by "Feedback."

63: Auto Reverse

This effect records the input signal and automatically plays it in reverse (the effect is similar to a tape reverse sound).

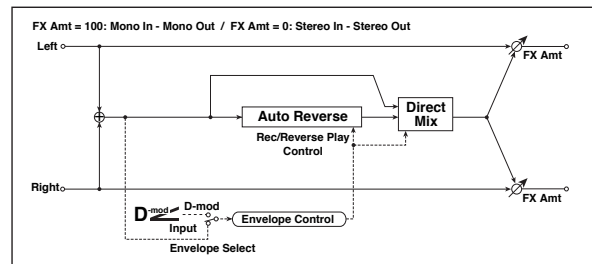

a	Rec Mode	Single, Multi	Sets the recording mode
b	Reverse Time [msec]	20...2640	Sets the maximum duration of the reverse playback
c	Envelope Select	D-mod, Input	Selects whether the start and end of recording is controlled via the modulation source or the input signal level
	Src	Off...Tempo	Selects the modulation source that controls recording when Envelope Select is set to D-mod
d	Threshold	0...100	Sets the recording start level when Envelope Select is set to Input
e	Response	0...100	Sets the speed of the response to the end of recording
f	Direct Mix	Always On, Always Off, Cross Fade	Selects how a dry sound is mixed
g	Wet/Dry	Dry, 1:99...99:1, Wet	Balance between the wet and dry signal
	Src	Off...Tempo	Table, "Dynamic Modulation sources," on page 357
	Amt	-100...+100	Amount of modulation source

a: Rec Mode

b: Reverse Time [msec]

When "Rec Mode" is set to Single, you can set up to 2,640msec for "Reverse Time." If recording starts during the reverse playback, the playback will be interrupted.

When "Rec Mode" is set to Multi, you can make another recording during the reverse playback. However, the maximum Reverse Time is limited to 1,320msec.

If you wish to record a phrase or rhythm pattern, set "Rec Mode" to Single. If you record only one note, set "Rec Mode" to Multi.

The "Reverse Time" parameter specifies the maximum duration of the reverse playback. The part in excess of this limit will not be played in reverse. If you wish to add short pieces of the reverse playback of single notes, make the "Reverse Time" shorter.

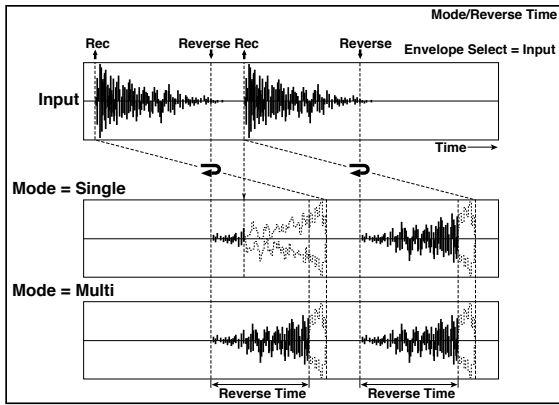

- c: Envelope Select
- c: Src
- d: Threshold

These parameters select the source to control the start and end of recording.

When “Envelope Select” is set to D-mod, the input signal will be recorded only when the value of the modulation source selected by the Src parameter is 64 or higher.

When “Envelope Select” is set to Input, the input signal will be recorded only when its level exceeds the Threshold level.

When recording is completed, reverse playback starts immediately.

64: Sequence BPM Dly (Sequence BPM Delay)

This four-tap delay enables you to select a tempo and rhythm pattern to set up each tap.

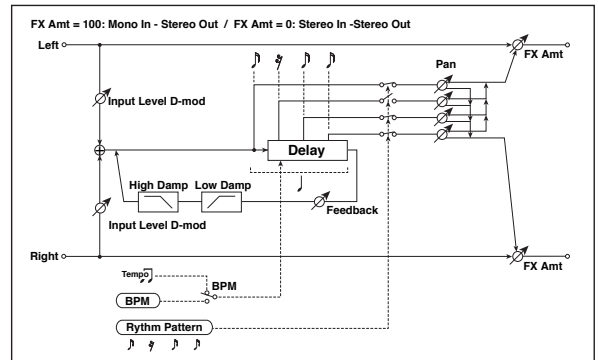

a	BPM	MIDI, 40.00... 300.00	MIDI syncs to the system tempo; 40–300 sets the tempo manually for this individual effect	
b	Rhythm Pattern	x...eee ³	Selects a rhythm pattern	
c	Tap1 Pan	L, 1...99, R	Sets the panning of Tap1	
	Tap2 Pan	L, 1...99, R	Sets the panning of Tap2	
	Tap3 Pan	L, 1...99, R	Sets the panning of Tap3	
	Tap4 Pan	L, 1...99, R	Sets the panning of Tap4	
d	Feedback	–100...+100	Sets the feedback amount	
	Src	Off...Tempo	Selects the modulation source of feedback amount	
	Amt	–100...+100	Sets the feedback amount	
e	High Damp [%]	0...100	Sets the damping amount in the high range	
	Low Damp [%]	0...100	Sets the damping amount in the low range	
f	Input Level Dmod [%]	–100...+100	Sets the modulation amount of the input level	
	Src	Off...Tempo	Selects the modulation source for the input level	
g	Wet/Dry	Dry, 1:99...99:1, Wet	Balance between the wet and dry signal	
	Src	Off...Tempo	Table, “Dynamic Modulation sources,” on page 357	
	Amt	–100...+100	Amount of modulation source	

- a: BPM
- b: Rhythm Pattern

With the tempo specified by the “BPM” parameter (or the MIDI Clock tempo if “BPM” is set to MIDI), the length of one beat equals the feedback delay time, and the interval between taps becomes equal. Selecting a rhythm pattern will automatically turn the tap outputs on and off. When “BPM” is set to MIDI, the lower limit of the “BPM” is 44.

65: L/C/R BPM Delay

The L/C/R delay enables you to match the delay time with the song tempo. You can also synchronize the delay time with the arpeggiator or sequencer. If you program the tempo before performance, you can achieve a delay effect that synchronizes with the song in real-time. Delay time is set by notes.

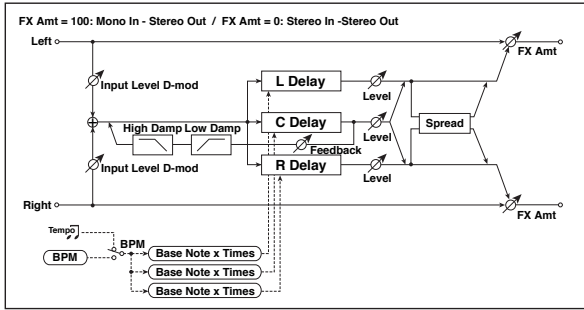

a	BPM	MIDI, 40.00...300.00	MIDI syncs to the system tempo; 40-300 sets the tempo manually for this individual effect	
	Time Over?	---, OVER!	Displays an error message when the delay time exceeds the upper limit	
b	L Delay Base Note	r...w	Selects the type of notes to specify the delay time for TapL	
	Times	x1...x32	Sets the number of notes to specify the delay time for TapL	
	Level	0...50	Sets the output level of TapL	
c	C Delay Base Note	r...w	Selects the type of notes to specify the delay time for TapC	
	Times	x1...x32	Sets the number of notes to specify the delay time for TapC	
	Level	0...50	Sets the output level of TapC	
d	R Delay Base Note	r...w	Selects the type of notes to specify the delay time for TapR	
	Times	x1...x32	Sets the number of notes to specify the delay time for TapR	
	Level	0...50	Sets the output level of TapR	
e	Feedback (C Delay)	-100...+100	Sets the feedback amount of TapC	
	Src	Off...Tempo	Selects the modulation source for the TapC feedback	
f	Amt	-100...+100	Sets the modulation amount of the TapC feedback	
	High Damp [%]	0...100	Sets the damping amount in the high range	
g	Low Damp [%]	0...100	Sets the damping amount in the low range	
	Input Level Dmod [%]	-100...+100	Sets the modulation amount of the input level	
h	Src	Off...Tempo	Selects the modulation source for the input level	
	Spread	0...50	Sets the width of the stereo image of the effect sound	
i	Wet/Dry	Dry, 1:99...99:1, Wet	Balance between the wet and dry signal	
	Src	Off...Tempo	Table, "Dynamic Modulation sources," on page 357	
	Amt	-100...+100	Amount of modulation source	

a: Time Over?

You can set the delay time up to 5,460msec. If the delay time exceeds this limit, the error message "OVER!" appears in the display. Set the delay time parameters so that this message will not appear. "Time Over?" is only a display parameter.

66: Stereo BPM Delay

This stereo delay enables you to set the delay time to match the song tempo.

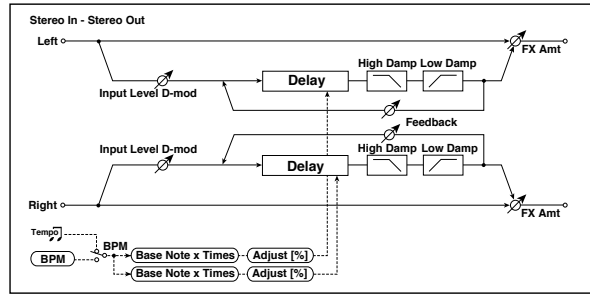

a	BPM	MIDI, 40.00...300.00	MIDI syncs to the system tempo; 40-300 sets the tempo manually for this individual effect	
	Time Over? L	---, OVER!	Display the error message if the left channel delay time exceeds the upper limit	
	R	---, OVER!	Display the error message if the right channel delay time exceeds the upper limit	
b	L Delay Base Note	r...w	Selects the type of notes to specify the left channel delay time	
	Times	x1...x32	Sets the number of notes to specify the left channel delay time	
	Adjust [%]	-2.50...+2.50	Fine-adjust the left channel delay time	
c	R Delay Base Note	r...w	Selects the type of notes to specify the right channel delay time	
	Times	x1...x32	Sets the number of notes to specify the right channel delay time	
	Adjust [%]	-2.50...+2.50	Fine-adjust the right channel delay time	
d	L Feedback	-100...+100	Sets the feedback amount for the left channel	
	Src	Off...Tempo	Selects the modulation source of feedback amount	
	Amt L	-100...+100	Sets the modulation amount of the left channel feedback	
e	R Feedback	-100...+100	Sets the feedback amount for the right channel	
	Amt R	-100...+100	Sets the modulation amount of the right channel feedback	
f	High Damp [%]	0...100	Sets the damping amount in the high range	
g	Low Damp [%]	0...100	Sets the damping amount in the low range	
h	Input Level Dmod [%]	-100...+100	Sets the modulation amount of the input level	
	Src	Off...Tempo	Selects the modulation source for the input level	
i	Wet/Dry	Dry, 1:99...99:1, Wet	Balance between the wet and dry signal	
	Src	Off...Tempo	Table, "Dynamic Modulation sources," on page 357	
	Amt	-100...+100	Amount of modulation source	

a: Time Over? L, R

You can set the delay time up to 2,730msec. If the delay time exceeds this limit, the error message "OVER!" appears in the display. Set the delay time parameters so that this message will not appear. "Time Over?" is only a display parameter.

67: St.BPM Mtap Delay (Stereo BPM Multi tap Delay)

This four-tap delay enables you to select a tempo and rhythm pattern to set up each tap.

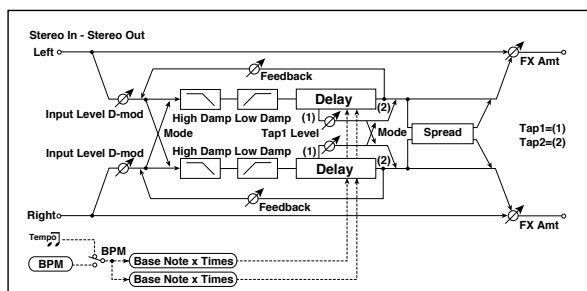

a	Mode	Normal, Cross Feedback, Cross Pan1, Cross Pan2	Switches the left and right delay routing	
b	BPM	MIDI, 40.00... 300.00	MIDI syncs to the system tempo; 40–300 sets the tempo manually for this individual effect	
	Time Over? 1	---, OVER!	Displays an error message when the delay time for Tap1 exceeds the upper limit	
	2	---, OVER!	Displays an error message when the delay time for Tap2 exceeds the upper limit	
c	Tap 1 Base Note	r...w	Selects the type of notes to specify the delay time for Tap1	
	Times	x1...x32	Sets the number of notes to specify the delay time for Tap1	
d	Tap 2 Base Note	r...w	Selects the type of notes to specify the delay time for Tap2	
	Times	x1...x32	Sets the number of notes to specify the delay time for Tap2	
e	Tap1 Level	0...100	Sets the Tap1 output level	
f	Feedback (Tap2)	-100...+100	Sets the Tap2 feedback amount	
	Src	Off...Tempo	Selects the modulation source of the Tap2 feedback amount	
	Amt	-100...+100	Sets the modulation amount of the Tap2 feedback amount	
g	High Damp [%]	0...100	Sets the damping amount in the high range	
	Low Damp [%]	0...100	Sets the damping amount in the low range	
h	Input Level Dmod [%]	-100...+100	Sets the modulation amount of the input level	
	Src	Off...Tempo	Selects the modulation source for the input level	
i	Spread	-100...+100	Sets the width of the stereo image of the effect sound	
	Src	Off...Tempo	Selects the modulation source of the effect sound's stereo image width	
	Amt	-100...+100	Sets the modulation amount of the effect sound's stereo image width	
j	Wet/Dry	Dry, 1:99...99:1, Wet	Balance between the wet and dry signal	
	Src	Off...Tempo	Table , "Dynamic Modulation sources," on page 357	
	Amt	-100...+100	Amount of modulation source	

68: St.BPM Mod. Delay (Stereo BPM Modulation Delay)

This is a stereo modulation delay that lets you synchronize the delay time to the tempo of the song.

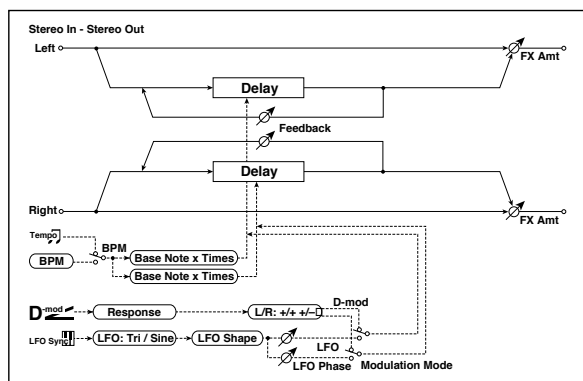

a	Modulation Mode	LFO, D-mod	Switches between LFO modulation control and modulation source control	
b	D-mod Modulation	L/R: +/+ , L/R: +/-	Reversed L/R control by modulation source	
	Src	Off...Tempo	Selects the modulation source that controls delay time	
	Response	0...30	Sets the rate of response to the modulation source	
c	LFO Waveform	Triangle, Sine	Selects the LFO Waveform	
	LFO Shape	-100...+100	Changes the curvature of the LFO Waveform	
d	LFO Sync	Off, On	Switches LFO reset off/on	
	Src	Off...Tempo	Selects the modulation source that resets the LFO	
e	LFO Frequency [Hz]	0.02...20.00	Sets the speed of the LFO	
f	MIDI Sync	Off, On	When this is on, the LFO speed is set by BPM, Base Note, and Times, instead of Frequency	
	BPM	MIDI, 40.00... 300.00	MIDI syncs to the system tempo; 40–300 sets the tempo manually for this individual effect	
	Base Note	r...w	Selects the type of notes that specify the LFO speed	
	Times	x1...x32	Sets the number of notes that specify the LFO speed	
g	L LFO Phase [deg]	-180...+180	Sets the phase obtained when the left LFO is reset	
	Depth	0...200	Sets the depth of the left LFO modulation	
h	R LFO Phase [deg]	-180...+180	Sets the phase obtained when the right LFO is reset	
	Depth	0...200	Sets the depth of the right LFO modulation	
i	BPM(Delay)	MIDI, 40.00... 300.00	MIDI syncs to the system tempo; 40–300 sets the tempo manually for this individual effect	
	Time Over? L	---, OVER!	Display the error message if the left channel delay time exceeds the upper limit	
	R	---, OVER!	Display the error message if the right channel delay time exceeds the upper limit	
j	L Delay Base Note	r...w	Selects the type of notes to specify the left channel delay time	
	Times	x1...x32	Sets the number of notes to specify the left channel delay time	
	Feedback	-100...+100	Sets the feedback amount of left delay	
k	R Delay Base Note	r...w	Selects the type of notes to specify the right channel delay time	
	Times	x1...x32	Sets the number of notes to specify the right channel delay time	
	Feedback	-100...+100	Sets the feedback amount of right delay	

i	Wet/Dry	-Wet, -1:99...Dry...99:1, Wet	Balance between the wet and dry signal
	Src	Off...Tempo	Table, "Dynamic Modulation sources," on page 357
	Amt	-100...+100	Amount of modulation source

i: Time Over? L, R

You can set the delay time up to 2,550msec. If the delay time exceeds this limit, the error message "OVER!" appears in the display. Set the delay time parameters so that this message will not appear. "Time Over?" is only a display parameter.

**69: St.BPMAutoPanDly
(Stereo BPM Auto Panning Delay)**

This stereo auto panning delay enables you to set the delay time to match the song tempo.

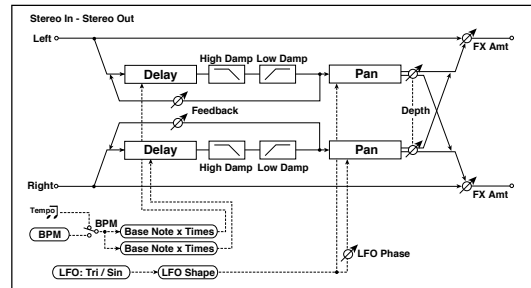

a	BPM	MIDI, 40.00...300.00	MIDI syncs to the system tempo; 40–300 sets the tempo manually for this individual effect	
	Time Over? L	---, OVER!	Display the error message if the left channel delay time exceeds the upper limit	
	R	---, OVER!	Display the error message if the right channel delay time exceeds the upper limit	
b	L Delay Base Note	r...w	Selects the type of notes to specify the left channel delay time	
	Times	x1...x32	Sets the number of notes to specify the left channel delay time	
	Feedback	-100...+100	Sets the feedback amount for the left channel	
c	R Delay Base Note	r...w	Selects the type of notes to specify the right channel delay time	
	Times	x1...x32	Sets the number of notes to specify the right channel delay time	
	Feedback	-100...+100	Sets the feedback amount for the right channel	
d	High Damp [%]	0...100	Sets the damping amount in the high range	
	Low Damp [%]	0...100	Sets the damping amount in the low range	
e	LFO Waveform	Triangle, Sine	Selects the LFO Waveform	
	Shape	-100...+100	Changes the curvature of the LFO Waveform	
	LFO Phase	-180...+180	Sets the LFO phase difference between the left and right	
f	Panning Freq [Hz]	0.02...20.00	Sets the panning speed	
g	MIDI Sync	Off, On	When this is on, the pan LFO speed is set by BPM, Base Note, and Times, instead of Frequency	
	BPM	MIDI, 40.00...300.00	MIDI syncs to the system tempo; 40–300 sets the tempo manually for this individual effect	
	Base Note	r...w	Selects the type of notes to specify the delay time for the panning	
	Times	x1...x32	Sets the number of notes to specify the delay time for the panning speed	
h	Panning Depth	0...100	Sets the panning width	
	Src	Off...Tempo	Selects the modulation source for the panning width	
	Amt	-100...+100	Set the modulation amount of the panning width	
i	Wet/Dry	Dry, 1:99...99:1, Wet	Balance between the wet and dry signal	
	Src	Off...Tempo	Table, "Dynamic Modulation sources," on page 357	
	Amt	-100...+100	Amount of modulation source	

70: Tape Echo BPM

This is a tape echo that lets you synchronize the delay time to the tempo of the song.

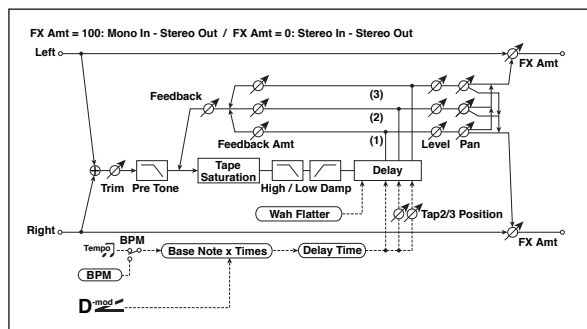

- a: Tap1 Dmod Src
- b: Tap1 Delay Note
- b: Times
- c: Tap1 Dmod Note
- c: Times

If “Tap1 Dmod Src” is Off or the selected modulation is at 0, the delay time will be the length specified by “Tap1 Delay Note” and “Times.”

If “Tap1 Dmod Src” is other than Off, the delay time will change so that it will be as specified by “Tap1 Dmod Note” and “Times” when the maximum modulation is reached.

b: Time Over?

You can set the delay time up to 5,400msec. If the delay time exceeds this limit, the error message “OVER!” appears in the display. Set the delay time parameters so that this message will not appear. “Time Over?” is only a display parameter.

a	BPM (Delay)	MIDI, 40.00...300.00	MIDI syncs to the system tempo; 40–300 sets the tempo manually for this individual effect	
	Tap1 Dmod Src	Off...Tempo	Selects the modulation source of the delay time	
b	Tap1 Delay Note	r...w	Selects the type of notes to specify the delay time (tap1)	
	Times	x1...x32	Sets the number of notes to specify the delay time (tap1)	
	Time Over?	---, OVER!	Displays an error message when the delay time exceeds the upper limit	
c	Tap1 Dmod Note	r...w	Selects the note value used to specify the delay time when the modulation is at maximum	
	Times	x1...x32	Specifies the number of notes used to specify the delay time when the modulation is at maximum	
d	Tap2 Position [%]	0...100	Sets the position of Tap 2 relative to the Tap 1 delay time the depth of pitch variation	
e	Tap3 Position [%]	0...100	Sets the position of Tap 3 relative to the Tap 1 delay time the depth of pitch variation	
f	Tap1 Level	0...100	Sets the Tap1 output level	
	Pan	L, 1...99, R	Sets the stereo image of tap1	
	FB Amt	-100...+100	Sets the Tap1 feedback amount	
g	Tap2 Level	0...100	Sets the Tap2 output level	
	Pan	L, 1...99, R	Sets the stereo image of tap2	
	FB Amt	-100...+100	Sets the Tap2 feedback amount	
h	Tap3 Level	0...100	Sets the Tap3 output level	
	Pan	L, 1...99, R	Sets the stereo image of tap3	
	FB Amt	-100...+100	Sets the Tap3 feedback amount	
i	Feedback	0...100	Sets the amount of feedback for Taps 1, 2, and 3	
	Src	Off...Tempo	Selects the modulation source of feedback amount	
	Amt	-100...+100	Sets the depth by which feedback amount will be modulated	
j	High Damp [%]	0...100	Sets the damping amount in the high range	
	Low Damp [%]	0...100	Sets the damping amount in the low range	
k	Saturation	0...100	Sets the distortion amount	
l	Input Trim	0...100	Sets the input gain	
	Pre Tone	0...100	Sets the tone of the input	
m	Wow Flutter [Hz]	0.02...1.00	Sets the frequency at which pitch variation will occur	
	Wow Flutter depth	0...100	Sets the depth of pitch variation	
n	Wet/Dry	Dry, 1:99...99:1, Wet	Balance between the wet and dry signal	
	Src	Off...Tempo	Table , “Dynamic Modulation sources,” on page 357	
	Amt	-100...+100	Amount of modulation source	

Reverb and Early Reflections (Reverb ER)

71: Reverb Hall

This hall-type reverb simulates the reverberation of mid-size concert halls or ensemble halls.

72: Reverb SmoothHall

This hall-type reverb simulates the reverberation of larger halls and stadiums, and creates a smooth release.

73: Reverb Wet Plate

This plate reverb simulates warm (dense) reverberation.

74: Reverb Dry Plate

This plate reverb simulates dry (light) reverberation.

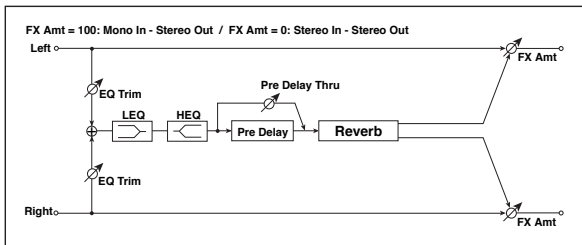

a	Reverb Time [sec]	0.1...10.0	Sets the reverberation time	
	High Damp [%]	0...100	Sets the damping amount in the high range	
b	Pre Delay [msec]	0...200	Sets the delay time from the dry sound	
	Pre Delay Thru [%]	0...100	Sets the mix ratio of non-delay sound	
c	EQ Trim	0...100	Sets the EQ input level	
d	Pre LEQ Fc	Low, Mid-Low	Selects the cutoff frequency (low or mid-low) of the low-range equalizer	
	Pre HEQ Fc	High, Mid-High	Selects the cutoff frequency (high or mid-high) of the high-range equalizer	
e	Pre LEQ Gain [dB]	-15.0...+15.0	Sets the gain of Low EQ	
	Pre HEQ Gain [dB]	-15.0...+15.0	Sets the gain of High EQ	
f	Wet/Dry	Dry, 1:99...99:1, Wet	Balance between the wet and dry signal	
	Src	Off...Tempo	Table, "Dynamic Modulation sources," on page 357	
	Amt	-100...+100	Amount of modulation source	

b: Pre Delay [msec]

b: Pre Delay Thru [%]

The "Pre Delay" sets the delay time to the reverb input, allowing you to control spaciousness.

Using the "Pre Delay Thru" parameter, you can mix the dry sound without delay, emphasizing the attack of the sound.

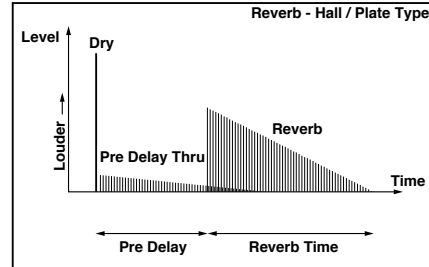

75: Reverb Room

This room-type reverb emphasizes the early reflections that make the sound tighter. Changing the balance between the early reflections and reverb sound allows you to simulate nuances, such as the type of walls of a room.

76: Reverb BrightRoom

This room-type reverb emphasizes the early reflections that make the sound brighter.

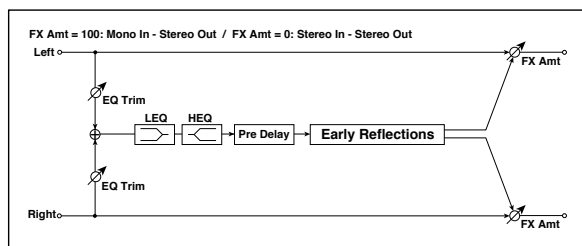
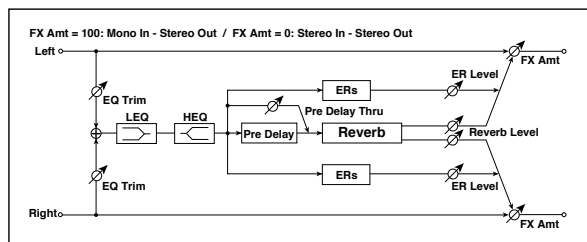

a	Reverb Time [sec]	0.1...3.0	Sets the reverberation time
	High Damp [%]	0...100	Sets the damping amount in the high range
b	Pre Delay [msec]	0...200	Sets the delay time from the dry sound
	Pre Delay Thru [%]	0...100	Sets the mix ratio of non-delay sound
c	ER Level	0...100	Sets the level of early reflections
d	Reverb Level	0...100	Sets the reverberation level
e	EQ Trim	0...100	Sets the EQ input level
f	Pre LEQ Fc	Low, Mid-Low	Selects the cutoff frequency (low or mid-low) of the low-range equalizer
	Pre HEQ Fc	High, Mid-High	Selects the cutoff frequency (high or mid-high) of the high-range equalizer
g	Pre LEQ Gain [dB]	-15.0...+15.0	Sets the gain of Low EQ
	Pre HEQ Gain [dB]	-15.0...+15.0	Sets the gain of High EQ
h	Wet/Dry	Dry, 1:99...99:1, Wet	Balance between the wet and dry signal
	Src	Off...Tempo	Table, "Dynamic Modulation sources," on page 357
	Amt	-100...+100	Amount of modulation source

a	Type	Sharp, Loose, Modulated, Reverse	Selects the decay curve for the early reflection
b	ER Time [msec]	10...800	Sets the time length of early reflection
c	Pre Delay [msec]	0...200	Sets the time taken from the original sound to the first early reflection
d	EQ Trim	0...100	Sets the input level of EQ applied to the effect sound
e	Pre LEQ Fc	Low, Mid-Low	Selects the cutoff frequency (low or mid-low) of the low-range equalizer
	Pre HEQ Fc	High, Mid-High	Selects the cutoff frequency (high or mid-high) of the high-range equalizer
f	Pre LEQ Gain [dB]	-15.0...+15.0	Gain of the Low EQ
	Pre HEQ Gain [dB]	-15.0...+15.0	Gain of the High EQ
g	Wet/Dry	Dry, 1:99...99:1, Wet	Balance between the wet and dry signal
	Src	Off...Tempo	Table, "Dynamic Modulation sources," on page 357
	Amt	-100...+100	Amount of modulation source

c: ER Level

d: Reverb Level

These parameters set the early reflection level and reverb level.

Changing these parameter values allows you to simulate the type of walls in the room. That is, a larger "ER Level" simulates a hard wall, and a larger "Reverb Level" simulates a soft wall.

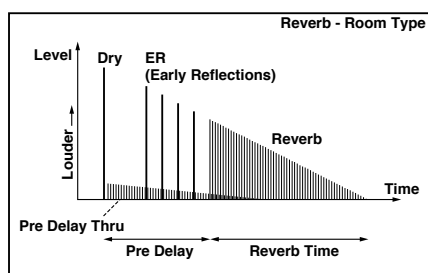

a: Type

This parameter selects the decay curve for the early reflection.

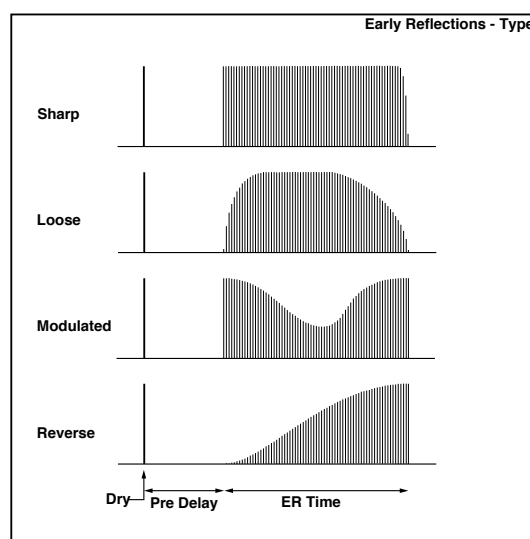

77: Early Reflections

This effect is only the early reflection part of a reverberation sound, and adds presence to the sound. You can select one of the four decay curves.

Mono-Mono Serial (Mono-Mono)

78: P4EQ - Exciter (Parametric 4-Band EQ - Exciter)

This effect combines a mono four-band parametric equalizer and an exciter.

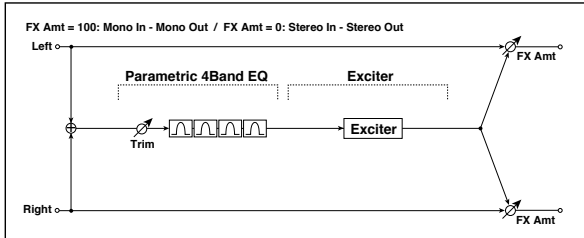

P4EQ			
a	[E]Trim	0...100	Sets the parametric EQ input level
b	[E]B1 Cutoff [Hz]	20...1.00k	Sets the center frequency of Band 1
	Q	0.5...10.0	Sets the bandwidth of Band 1
	Gain [dB]	-18...+18	Sets the gain of Band 1
c	[E]B2 Cutoff [Hz]	50...5.00k	Sets the center frequency of Band 2
	Q	0.5...10.0	Sets the bandwidth of Band 2
	Gain [dB]	-18...+18	Sets the gain of Band 2
d	[E]B3 Cutoff [Hz]	300...10.00k	Sets the center frequency of Band 3
	Q	0.5...10.0	Sets the bandwidth of Band 3
	Gain [dB]	-18...+18	Sets the gain of Band 3
e	[E]B4 Cutoff [Hz]	500...20.00k	Sets the center frequency of Band 4
	Q	0.5...10.0	Sets the bandwidth of Band 4
	Gain [dB]	-18...+18	Sets the gain of Band 4
EXCITER			
f	[X]Exciter Blend	-100...+100	Sets the intensity (depth) of the Exciter effect
g	[X]Emphasis Freq	0...70	Sets the frequency range to be emphasized
h	Wet/Dry	Dry, 1:99...99:1, Wet	Balance between the wet and dry signal
	Src	Off...Tempo	Table, "Dynamic Modulation sources," on page 357
	Amt	-100...+100	Amount of modulation source

79: P4EQ - Wah (Parametric 4-Band EQ - Wah/Auto Wah)

This effect combines a mono four-band parametric equalizer and a wah. You can change the order of the connection.

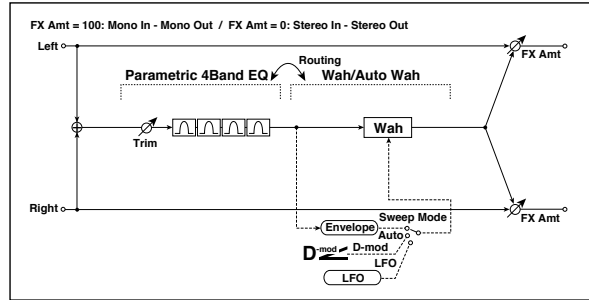

P4EQ			
a	[E]Trim	0...100	Sets the parametric EQ input level
Routing	P4EQ Wah, Wah P4EQ	Changes the order of the parametric equalizer and wah connection	
b	[E]B1 Cutoff [Hz]	20...1.00k	Sets the center frequency of Band 1
	Q	0.5...10.0	Sets the bandwidth of Band 1
	Gain [dB]	-18...+18	Sets the gain of Band 1
c	[E]B2 Cutoff [Hz]	50...5.00k	Sets the center frequency of Band 2
	Q	0.5...10.0	Sets the bandwidth of Band 2
	Gain [dB]	-18...+18	Sets the gain of Band 2
d	[E]B3 Cutoff [Hz]	300...10.00k	Sets the center frequency of Band 3
	Q	0.5...10.0	Sets the bandwidth of Band 3
	Gain [dB]	-18...+18	Sets the gain of Band 3
e	[E]B4 Cutoff [Hz]	500...20.00k	Sets the center frequency of Band 4
	Q	0.5...10.0	Sets the bandwidth of Band 4
	Gain [dB]	-18...+18	Sets the gain of Band 4
WAH			
f	[W]Frequency Bottom	0...100	Sets the lower limit of the wah center frequency
	Frequency Top	0...100	Sets the upper limit of the wah center frequency
g	[W]Sweep Mode	Auto, D-mod, LFO	Selects the control from auto-wah, modulation source, and LFO
	Src	Off...Tempo	Selects the modulation source for the wah when Sweep Mode=D-mod
h	[W]LFO Frequency [Hz]	0.02...20.00	Sets the speed of the LFO
	Resonance	0...100	Sets the resonance amount
	LPF	Off, On	Switches the wah low pass filter on and off
i	[W]Wet/Dry	Dry, 1:99...99:1, Wet	Sets the wah effect balance
	Src	Off...Tempo	Selects the Wet/Dry modulation source for the wah
	Amt	-100...+100	Sets the Wet/Dry modulation amount for the wah
j	Wet/Dry	Dry, 1:99...99:1, Wet	Balance between the wet and dry signal
	Src	Off...Tempo	Table, "Dynamic Modulation sources," on page 357
	Amt	-100...+100	Amount of modulation source

80: P4EQ - Cho/Flng (Parametric 4-Band EQ - Chorus/Flanger)

This effect combines a mono four-band parametric equalizer and a chorus/flanger.

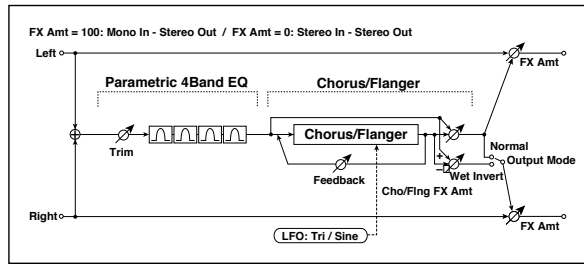

P4EQ			
a	[E]Trim	0...100	Sets the parametric EQ input level
b	[E]B1 Cutoff [Hz]	20...1.00k	Sets the center frequency of Band 1
	Q	0.5...10.0	Sets the bandwidth of Band 1
	Gain [dB]	-18...+18	Sets the gain of Band 1
c	[E]B2 Cutoff [Hz]	50...5.00k	Sets the center frequency of Band 2
	Q	0.5...10.0	Sets the bandwidth of Band 2
	Gain [dB]	-18...+18	Sets the gain of Band 2
d	[E]B3 Cutoff [Hz]	300...10.00k	Sets the center frequency of Band 3
	Q	0.5...10.0	Sets the bandwidth of Band 3
	Gain [dB]	-18...+18	Sets the gain of Band 3
e	[E]B4 Cutoff [Hz]	500...20.00k	Sets the center frequency of Band 4
	Q	0.5...10.0	Sets the bandwidth of Band 4
	Gain [dB]	-18...+18	Sets the gain of Band 4
CHORUS/FLANGER			
f	[F]LFO Frequency [Hz]	0.02...20.00	Sets the speed of the LFO
	LFO Waveform	Triangle, Sine	Selects the LFO Waveform
g	[F]Delay Time [msec]	0.0...1350.0	Sets the delay time
	Depth	0...100	Sets the depth of LFO modulation
	Feedback	-100...+100	Sets the feedback amount
h	[F]Cho/Flng Wet/Dry	-Wet, -1:99...Dry...99:1, Wet	Sets the effect balance of the chorus/flanger
	Src	Off...Tempo	Selects the Wet/Dry modulation source for the chorus/flanger
	Amt	-100...+100	Sets the Wet/Dry modulation amount for the chorus/flanger
i	[F]Output Mode	Normal, Wet Invert	Selects the output mode for the chorus/flanger
j	Wet/Dry	Dry, 1:99...99:1, Wet	Balance between the wet and dry signal
	Src	Off...Tempo	Table, "Dynamic Modulation sources," on page 357
	Amt	-100...+100	Amount of modulation source

i: Output Mode

When Wet Invert is selected, the right channel phase of the chorus/flanger effect sound is inverted. This creates pseudo-stereo effects and adds spread.

However, if a mono-input type effect is connected after this effect, the left and right sounds may cancel each other, eliminating the chorus/flanger effects.

81: P4EQ - Phaser (Parametric 4-Band EQ - Phaser)

This effect combines a mono four-band parametric equalizer and a phaser.

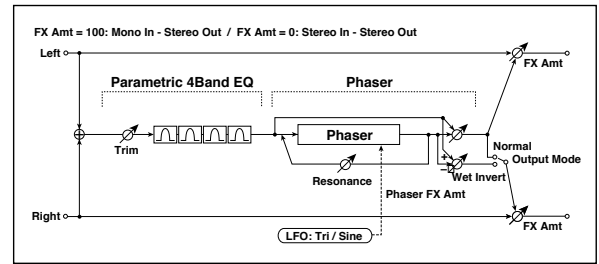

P4EQ			
a	[E]Trim	0...100	Sets the parametric EQ input level
b	[E]B1 Cutoff [Hz]	20...1.00k	Sets the center frequency of Band 1
	Q	0.5...10.0	Sets the bandwidth of Band 1
	Gain [dB]	-18...+18	Sets the gain of Band 1
c	[E]B2 Cutoff [Hz]	50...5.00k	Sets the center frequency of Band 2
	Q	0.5...10.0	Sets the bandwidth of Band 2
	Gain [dB]	-18...+18	Sets the gain of Band 2
d	[E]B3 Cutoff [Hz]	300...10.00k	Sets the center frequency of Band 3
	Q	0.5...10.0	Sets the bandwidth of Band 3
	Gain [dB]	-18...+18	Sets the gain of Band 3
e	[E]B4 Cutoff [Hz]	500...20.00k	Sets the center frequency of Band 4
	Q	0.5...10.0	Sets the bandwidth of Band 4
	Gain [dB]	-18...+18	Sets the gain of Band 4
PHASER			
f	[P]LFO Frequency [Hz]	0.02...20.00	Sets the speed of the LFO
	LFO Waveform	Triangle, Sine	Selects the LFO Waveform
g	[P]Manual	0...100	Sets the frequency to which the effect is applied
	Depth	0...100	Sets the depth of LFO modulation
	Resonance	-100...+100	Sets the resonance amount
h	[P]Phaser Wet/Dry	-Wet, -1:99...Dry...99:1, Wet	Sets the phaser effect balance
	Src	Off...Tempo	Selects the Wet/Dry modulation source for the phaser
	Amt	-100...+100	Sets the Wet/Dry modulation amount for the phaser
i	[P]Output Mode	Normal, Wet Invert	Selects the phaser output mode
j	Wet/Dry	Dry, 1:99...99:1, Wet	Balance between the wet and dry signal
	Src	Off...Tempo	Table, "Dynamic Modulation sources," on page 357
	Amt	-100...+100	Amount of modulation source

82: P4EQ - Mt. Delay (Parametric 4-Band EQ - Multitap Delay)

This effect combines a mono four-band parametric equalizer and a multitap delay.

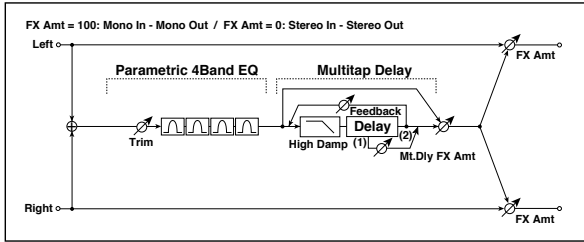

P4EQ			
a	[E]Trim	0...100	Sets the parametric EQ input level
b	[E]B1 Cutoff [Hz]	20...1.00k	Sets the center frequency of Band 1
	Q	0.5...10.0	Sets the bandwidth of Band 1
	Gain [dB]	-18...+18	Sets the gain of Band 1
c	[E]B2 Cutoff [Hz]	50...5.00k	Sets the center frequency of Band 2
	Q	0.5...10.0	Sets the bandwidth of Band 2
	Gain [dB]	-18...+18	Sets the gain of Band 2
d	[E]B3 Cutoff [Hz]	300...10.00k	Sets the center frequency of Band 3
	Q	0.5...10.0	Sets the bandwidth of Band 3
	Gain [dB]	-18...+18	Sets the gain of Band 3
e	[E]B4 Cutoff [Hz]	500...20.00k	Sets the center frequency of Band 4
	Q	0.5...10.0	Sets the bandwidth of Band 4
	Gain [dB]	-18...+18	Sets the gain of Band 4
MULTITAP DELAY			
f	[D]Tap1 Time [msec]	0.0...1360.0	Sets the Tap1 delay time
	Tap1 Level	0...100	Sets the Tap1 output level
g	[D]Tap2 Time [msec]	0.0...1360.0	Sets the Tap2 delay time
	Feedback (Tap2)	-100...+100	Sets the Tap2 feedback amount
h	[D]High Damp [%]	0...100	Sets the damping amount in the high range
i	[D]Mt.Delay Wet/Dry	Dry, 1:99...99:1, Wet	Sets the multitap delay effect balance
	Src	Off...Tempo	Selects the Wet/Dry modulation source for the multitap delay
	Amt	-100...+100	Sets the Wet/Dry modulation amount for the multitap delay
j	Wet/Dry	Dry, 1:99...99:1, Wet	Balance between the wet and dry signal
	Src	Off...Tempo	Table, "Dynamic Modulation sources," on page 357
	Amt	-100...+100	Amount of modulation source

83: Comp - Wah (Compressor - Wah/Auto Wah)

This effect combines a mono compressor and a wah. You can change the order of the connection.

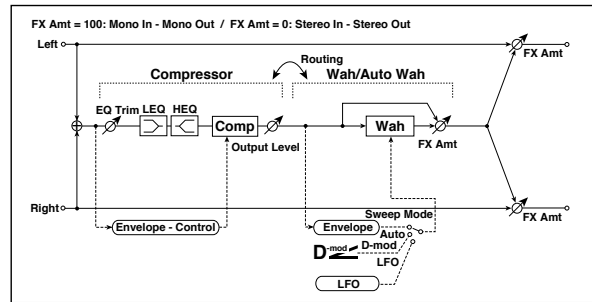

COMPRESSOR			
a	[C] Sensitivity	1...100	Sets the sensitivity
b	[C]Attack	1...100	Sets the attack level
	Output Level	0...100	Sets the compressor output level
c	[C]EQ Trim	0...100	Sets the EQ input level
d	[C]Pre LEQ Gain [dB]	-15...+15	Sets the gain of Low EQ
	Pre HEQ Gain [dB]	-15...+15	Sets the gain of High EQ
WAH			
e	[W]Frequency Bottom	0...100	Sets the lower limit of the wah center frequency
	Frequency Top	0...100	Sets the upper limit of the wah center frequency
f	[w]Sweep Mode	Auto, D-mod, LFO	Selects the control from auto-wah, modulation source, and LFO
	Src	Off...Tempo	Selects the modulation source for the wah when Sweep Mode=D-mod
g	[W]LFO Frequency [Hz]	0.02...20.00	Sets the speed of the LFO
	Resonance	0...100	Sets the resonance amount
	LPF	Off, On	Switches the wah low pass filter on and off
h	[W]Wet/Dry	Dry, 1:99...99:1, Wet	Sets the wah effect balance
	Src	Off...Tempo	Selects the Wet/Dry modulation source for the wah
	Amt	-100...+100	Sets the Wet/Dry modulation amount for the wah
i	Routing	Comp Wah, Wah Comp	Switches the order of the compressor and wah
j	Wet/Dry	Dry, 1:99...99:1, Wet	Balance between the wet and dry signal
	Src	Off...Tempo	Table, "Dynamic Modulation sources," on page 357
	Amt	-100...+100	Amount of modulation source

84: Comp - Amp Sim (Compressor - Amp Simulation)

This effect combines a mono compressor and an amp simulation. You can change the order of the effects.

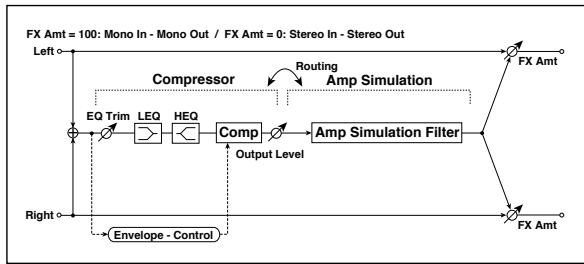

COMPRESSOR			
a	[C] Sensitivity	1...100	Sets the sensitivity
b	[C] Attack	1...100	Sets the attack level
	Output Level	0...100	Sets the compressor output level
c	[C] EQ Trim	0...100	Sets the EQ input level
d	[C] Pre LEQ Gain [dB]	-15...+15	Sets the gain of Low EQ
	Pre HEQ Gain [dB]	-15...+15	Sets the gain of High EQ
AMP SIM			
e	[A] Amplifier Type	SS, EL84, 6L6	Selects the type of guitar amplifier
f	Routing	Comp Amp, Amp Comp	Switches the order of the compressor and amp simulation
g	Wet/Dry	Dry, 1:99...99:1, Wet	Balance between the wet and dry signal
	Src	Off...Tempo	Table, "Dynamic Modulation sources," on page 357
	Amt	-100...+100	Amount of modulation source

85: Comp - OD/HiGain (Compressor - Overdrive/Hi.Gain)

This effect combines a mono compressor and an overdrive/high-gain distortion. You can change the order of the effects.

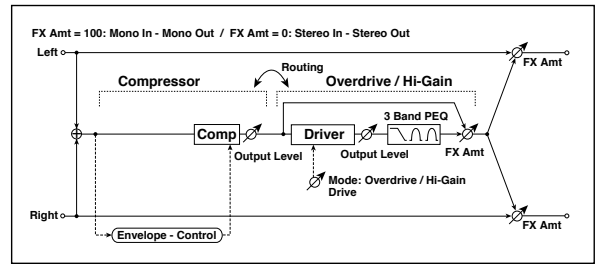

COMPRESSOR			
a	[C] Sensitivity	1...100	Sets the sensitivity
b	[C] Attack	1...100	Sets the attack level
	Output Level	0...100	Sets the compressor output level
OD/HI-GAIN			
c	[O] Drive Mode	Overdrive, Hi-Gain	Switches between overdrive and high-gain distortion
	Drive	1...100	Sets the degree of distortion
d	[O] Output Level	0...50	Sets the overdrive output level
	Src	Off...Tempo	Selects the modulation source for the overdrive output level
	Amt	-50...+50	Sets the modulation amount of the overdrive output level
e	[O] Low Cutoff [Hz]	20...1.00k	Sets the center frequency for Low EQ (shelving type)
	Gain [dB]	-18...+18	Sets the gain of Low EQ
f	[O] Mid1 Cutoff [Hz]	300...10.00k	Sets the center frequency for Mid/High EQ 1 (peaking type)
	Q	0.5...10.0	Sets the band width of Mid/High EQ 1
	Gain [dB]	-18...+18	Sets the gain of Mid/High EQ 1
g	[O] Mid2 Cutoff [Hz]	500...20.00k	Sets the center frequency for Mid/High EQ 2 (peaking type)
	Q	0.5...10.0	Sets the band width of Mid/High EQ 2
	Gain [dB]	-18...+18	Sets the gain of Mid/High EQ 2
h	[O] Wet/Dry	Dry, 1:99...99:1, Wet	Sets the overdrive effect balance
	Src	Off...Tempo	Selects the Wet/Dry modulation source for the overdrive
	Amt	-100...+100	Sets the Wet/Dry modulation amount for the overdrive
i	Routing	Comp OD/HG, OD/HG Comp	Switches the order of the compressor and overdrive
j	Wet/Dry	Dry, 1:99...99:1, Wet	Balance between the wet and dry signal
	Src	Off...Tempo	Table, "Dynamic Modulation sources," on page 357
	Amt	-100...+100	Amount of modulation source

86: Comp - P4EQ (Compressor - Parametric 4-Band EQ)

This effect combines a mono compressor and a four-band parametric equalizer. You can change the order of the effects.

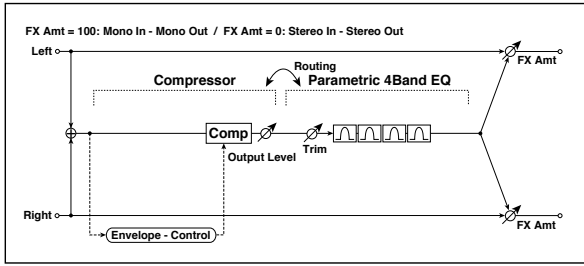

COMPRESSOR			
a	[C] Sensitivity	1...100	Sets the sensitivity
b	[C] Attack	1...100	Sets the attack level
	Output Level	0...100	Sets the compressor output level
P4EQ			
c	[E] Trim	0...100	Sets the parametric EQ input level
d	[E]B1 Cutoff [Hz]	20...1.00k	Sets the center frequency of Band 1
	Q	0.5...10.0	Sets the bandwidth of Band 1
	Gain [dB]	-18...+18	Sets the gain of Band 1
e	[E]B2 Cutoff [Hz]	50...5.00k	Sets the center frequency of Band 2
	Q	0.5...10.0	Sets the bandwidth of Band 2
	Gain [dB]	-18...+18	Sets the gain of Band 2
f	[E]B3 Cutoff [Hz]	300...10.00k	Sets the center frequency of Band 3
	Q	0.5...10.0	Sets the bandwidth of Band 3
	Gain [dB]	-18...+18	Sets the gain of Band 3
g	[E]B4 Cutoff [Hz]	500...20.00k	Sets the center frequency of Band 4
	Q	0.5...10.0	Sets the bandwidth of Band 4
	Gain [dB]	-18...+18	Sets the gain of Band 4
h	Routing	Comp P4EQ, P4EQ Comp	Switches the order of the compressor and parametric EQ
i	Wet/Dry	Dry, 1:99...99:1, Wet	Balance between the wet and dry signal
	Src	Off...Tempo	Table, "Dynamic Modulation sources," on page 357
	Amt	-100...+100	Amount of modulation source

87: Comp - Cho/Flng (Compressor - Chorus/Flanger)

This effect combines a mono compressor and a chorus/flanger. You can change the order of the effects.

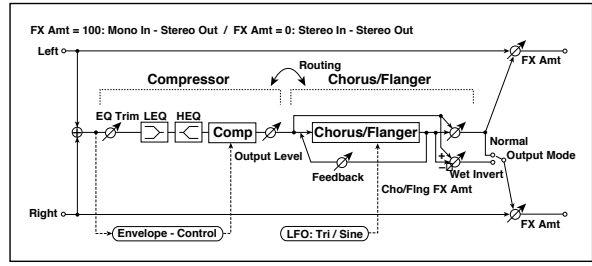

COMPRESSOR			
a	[C] Sensitivity	1...100	Sets the sensitivity
b	[C] Attack	1...100	Sets the attack level
	Output Level	0...100	Sets the compressor output level
c	[C]EQ Trim	0...100	Sets the EQ input level
d	[C]Pre LEQ Gain [dB]	-15...+15	Sets the gain of Low EQ
	Pre HEQ Gain [dB]	-15...+15	Sets the gain of High EQ
CHORUS/FLANGER			
e	[F]LFO Frequency [Hz]	0.02...20.00	Sets the speed of the LFO
	LFO Waveform	Triangle, Sine	Selects the LFO Waveform
f	[F]Delay Time [msec]	0.0...1350.0	Sets the delay time
	Depth	0...100	Sets the depth of LFO modulation
	Feedback	-100...+100	Sets the feedback amount
g	[F]Cho/Flng Wet/Dry	-Wet, -1:99...Dry...99:1, Wet	Sets the effect balance of the chorus/flanger
	Src	Off...Tempo	Selects the Wet/Dry modulation source for the chorus/flanger
	Amt	-100...+100	Sets the Wet/Dry modulation amount for the chorus/flanger
h	[F]Output Mode	Normal, Wet Invert	Selects the output mode for the chorus/flanger
i	Routing	Comp Flanger, Flanger Comp	Switches the order of the compressor and chorus/flanger
j	Wet/Dry	Dry, 1:99...99:1, Wet	Balance between the wet and dry signal
	Src	Off...Tempo	Table, "Dynamic Modulation sources," on page 357
	Amt	-100...+100	Amount of modulation source

h: [F]Output Mode

i: Routing

When Wet Invert is selected, the right channel phase of the chorus/flanger effect sound is inverted. This creates pseudo-stereo effects and adds spread.

However, if a mono-input type effect is connected after this effect, the left and right sounds may cancel each other, eliminating the chorus/flanger effects.

When "Routing" is set to Flanger & Comp, "[F]Output Mode" will be set to Normal.

88: Comp - Phaser (Compressor - Phaser)

This effect combines a mono compressor and a phaser. You can change the order of the effects.

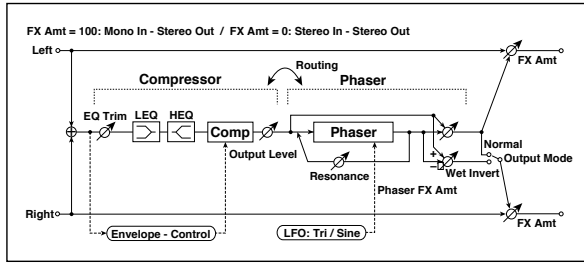

COMPRESSOR			
a	[C] Sensitivity	1...100	Sets the sensitivity
b	[C] Attack	1...100	Sets the attack level
	Output Level	0...100	Sets the compressor output level
c	[C] EQ Trim	0...100	Sets the EQ input level
d	[C] Pre LEQ Gain [dB]	-15...+15	Sets the gain of Low EQ
	Pre HEQ Gain [dB]	-15...+15	Sets the gain of High EQ
PHASER			
e	[P] LFO Frequency [Hz]	0.02...20.00	Sets the speed of the LFO
	LFO Waveform	Triangle, Sine	Selects the LFO Waveform
f	[P] Manual	0...100	Sets the frequency to which the effect is applied
	Depth	0...100	Sets the depth of LFO modulation
	Resonance	-100...+100	Sets the resonance amount
g	[P] Phaser Wet/Dry	-Wet, -1:99...Dry...99:1, Wet	Sets the phaser effect balance
	Src	Off...Tempo	Selects the Wet/Dry modulation source for the phaser
	Amt	-100...+100	Sets the Wet/Dry modulation amount for the phaser
h	[F] Output Mode	Normal, Wet Invert	Selects the phaser output mode
i	Routing	Comp Phaser, Phaser Comp	Switches the order of the compressor and phaser
j	Wet/Dry	Dry, 1:99...99:1, Wet	Balance between the wet and dry signal
	Src	Off...Tempo	Table, "Dynamic Modulation sources," on page 357
	Amt	-100...+100	Amount of modulation source

89: Comp - Mt. Delay (Compressor - Multitap Delay)

This effect combines a mono compressor and a multitap delay. You can change the order of the effects.

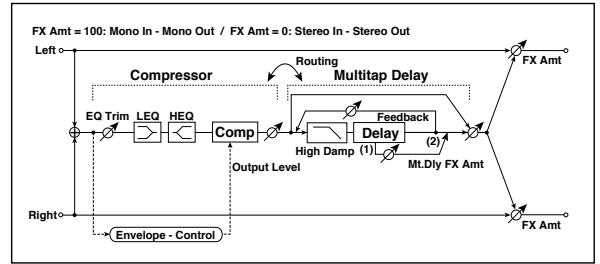

COMPRESSOR			
a	[C] Sensitivity	1...100	Sets the sensitivity
b	[C] Attack	1...100	Sets the attack level
	Output Level	0...100	Sets the compressor output level
c	[C] EQ Trim	0...100	Sets the EQ input level
d	[C] Pre LEQ Gain [dB]	-15...+15	Sets the gain of Low EQ
	Pre HEQ Gain [dB]	-15...+15	Sets the gain of High EQ
MULTITAP DELAY			
e	[D] Tap1 Time [msec]	0.0...1360.0	Sets the Tap1 delay time
	Tap1 Level	0...100	Sets the Tap1 output level
f	[D] Tap2 Time [msec]	0.0...1360.0	Sets the Tap2 delay time
	Feedback (Tap2)	-100...+100	Sets the Tap2 feedback amount
g	[D] High Damp [%]	0...100	Sets the damping amount in the high range
h	[D] Mt. Delay Wet/Dry	Dry, 1:99...99:1, Wet	Sets the multitap delay effect balance
	Src	Off...Tempo	Selects the Wet/Dry modulation source for the multitap delay
	Amt	-100...+100	Sets the Wet/Dry modulation amount for the multitap delay
i	Routing	Comp Mt.Delay, Mt.Delay Comp	Switches the order of the compressor and multitap delay
j	Wet/Dry	Dry, 1:99...99:1, Wet	Balance between the wet and dry signal
	Src	Off...Tempo	Table, "Dynamic Modulation sources," on page 357
	Amt	-100...+100	Amount of modulation source

90: Limiter - P4EQ (Limiter - Parametric 4-Band EQ)

This effect combines a mono limiter and a four-band parametric equalizer. You can change the order of the effects.

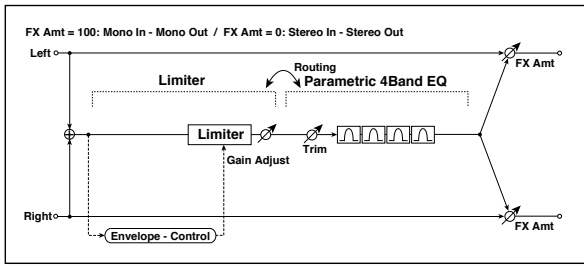

LIMITER			
a	[L]Ratio	1.0 : 1... 50.0 : 1, Inf : 1	Sets the signal compression ratio
	Threshold [dB]	-40...0	Sets the level above which the compressor is applied
b	[L]Attack	1...100	Sets the attack time
	Release	1...100	Sets the release time
c	[L]Gain Adjust [dB]	-Inf, -38...+24	Sets the limiter output gain
P4EQ			
d	[E]Trim	0...100	Sets the parametric EQ input level
e	[E]B1 Cutoff [Hz]	20...1.00k	Sets the center frequency of Band 1
	Q	0.5...10.0	Sets the bandwidth of Band 1
	Gain [dB]	-18...+18	Sets the gain of Band 1
f	[E]B2 Cutoff [Hz]	50...5.00k	Sets the center frequency of Band 2
	Q	0.5...10.0	Sets the bandwidth of Band 2
	Gain [dB]	-18...+18	Sets the gain of Band 2
g	[E]B3 Cutoff [Hz]	300...10.00k	Sets the center frequency of Band 3
	Q	0.5...10.0	Sets the bandwidth of Band 3
	Gain [dB]	-18...+18	Sets the gain of Band 3
h	[E]B4 Cutoff [Hz]	500...20.00k	Sets the center frequency of Band 4
	Q	0.5...10.0	Sets the bandwidth of Band 4
	Gain [dB]	-18...+18	Sets the gain of Band 4
i	Routing	Limiter P4EQ, P4EQ Limiter	Switches the order of the limiter and parametric EQ
j	Wet/Dry	Dry, 1:99...99:1, Wet	Balance between the wet and dry signal
	Src	Off...Tempo	Table, "Dynamic Modulation sources," on page 357
	Amt	-100...+100	Amount of modulation source

- a: [L]Ratio
- a: Threshold [dB]
- c: [L]Gain Adjust [dB]

This parameter sets the signal compression “[L]Ratio”. Compression is applied only when the signal level exceeds the “Threshold” value.

Adjust the output level using the “Gain Adjust” parameter, since compression causes the entire level to be reduced.

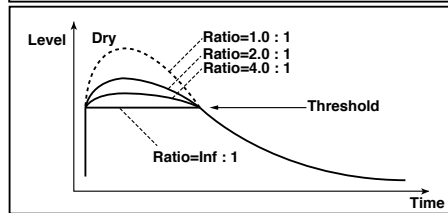
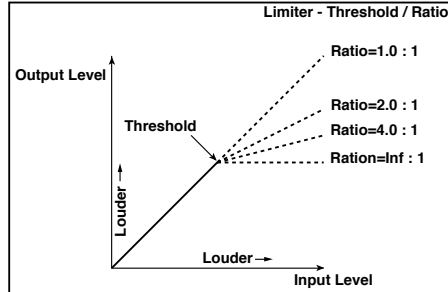

91: Limiter - Cho/Flng (Limiter - Chorus/Flanger)

This effect combines a mono limiter and a chorus/flanger. You can change the order of the effects.

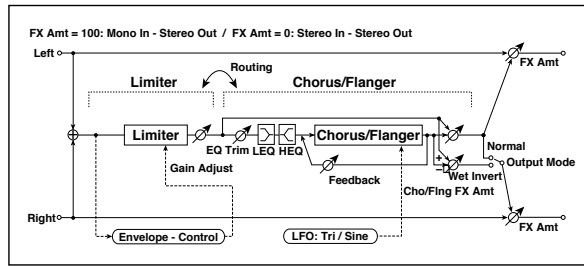

LIMITER			
a	[L]Ratio	1.0 : 1... 50.0 : 1, Inf : 1	Sets the signal compression ratio
	Threshold [dB]	-40...0	Sets the level above which the compressor is applied
b	[L]Attack	1...100	Sets the attack time
	Release	1...100	Sets the release time
c	[L]Gain Adjust [dB]	-Inf, -38...+24	Sets the limiter output gain
CHORUS/FLANGER			
d	[F]LFO Frequency [Hz]	0.02...20.00	Sets the speed of the LFO
	LFO Waveform	Triangle, Sine	Selects the LFO Waveform
e	[F]Delay Time [msec]	0.0...1350.0	Sets the delay time
	Depth	0...100	Sets the depth of LFO modulation
	Feedback	-100...+100	Sets the feedback amount
f	[F]EQ Trim	0...100	Sets the EQ input level
g	[F]Pre LEQ Gain [dB]	-15...+15	Sets the gain of Low EQ
	Pre HEQ Gain [dB]	-15...+15	Sets the gain of High EQ
h	[F]Cho/Flng Wet/Dry	-Wet, - 1:99...Dry...99:1 , Wet	Sets the effect balance of the chorus/flanger
	Src	Off...Tempo	Selects the Wet/Dry modulation source for the chorus/flanger
	Amt	-100...+100	Sets the Wet/Dry modulation amount for the chorus/flanger
i	[F]Output Mode	Normal, Wet Invert	Selects the output mode for the chorus/flanger
	Routing	Limiter Flanger, Flanger Limiter	Switches the order of the limiter and chorus/flanger
j	Wet/Dry	Dry, 1:99...99:1, Wet	Balance between the wet and dry signal
	Src	Off...Tempo	Table, "Dynamic Modulation sources," on page 357
	Amt	-100...+100	Amount of modulation source

92: Limiter - Phaser

This effect combines a mono limiter and a phaser. You can change the order of the effects.

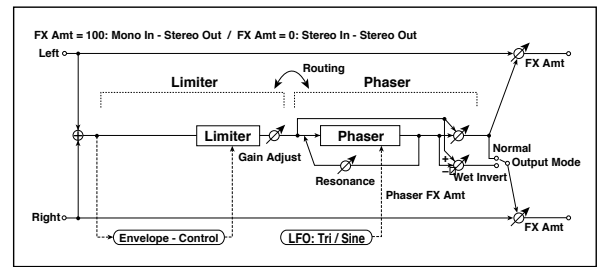

LIMITER			
a	[L]Ratio	1.0 : 1... 50.0 : 1, Inf : 1	Sets the signal compression ratio
	Threshold [dB]	-40...0	Sets the level above which the compressor is applied
b	[L]Attack	1...100	Sets the attack time
	Release	1...100	Sets the release time
c	[L]Gain Adjust [dB]	-Inf, -38...+24	Sets the limiter output gain
PHASER			
d	[P]LFO Frequency [Hz]	0.02...20.00	Sets the speed of the LFO
	LFO Waveform	Triangle, Sine	Selects the LFO Waveform
e	[P]Manual	0...100	Sets the frequency to which the effect is applied
	Depth	0...100	Sets the depth of LFO modulation
	Resonance	-100...+100	Sets the resonance amount
f	[P]Phaser Wet/Dry	-Wet, - 1:99...Dry...99:1 , Wet	Sets the phaser effect balance
	Src	Off...Tempo	Selects the phaser's Wet/Dry modulation source
	Amt	-100...+100	Sets the phaser's Wet/Dry modulation amount
g	[P]Output Mode	Normal, Wet Invert	Selects the phaser output mode
h	Routing	Limiter Phaser, Phaser Limiter	Switches the order of the limiter and phaser
i	Wet/Dry	Dry, 1:99...99:1, Wet	Balance between the wet and dry signal
	Src	Off...Tempo	Table, "Dynamic Modulation sources," on page 357
	Amt	-100...+100	Amount of modulation source

93: Limiter - Mt.Delay (Limiter - Multitap Delay)

This effect combines a mono limiter and a multitap delay. You can change the order of the effects.

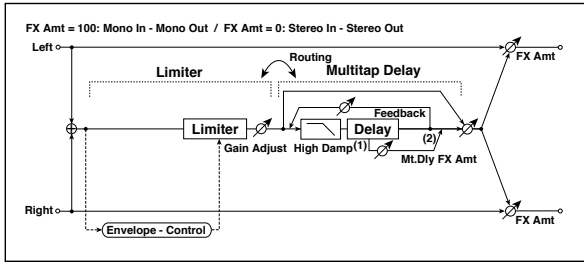

LIMITER			
a	[L]Ratio	1.0 : 1... 50.0 : 1, Inf : 1	Sets the signal compression ratio
	Threshold [dB]	-40...0	Sets the level above which the compressor is applied
b	[L]Attack	1...100	Sets the attack time
	Release	1...100	Sets the release time
c	[L]Gain Adjust [dB]	-Inf, -38...+24	Sets the limiter output gain
	MULTITAP DELAY		
d	[D]Tap1 Time [msec]	0.0...1360.0	Sets the Tap1 delay time
	Tap1 Level	0...100	Sets the Tap1 output level
e	[D]Tap2 Time [msec]	0.0...1360.0	Sets the Tap2 delay time
	Feedback	-100...+100	Sets the Tap2 feedback amount
f	[D]High Damp [%]	0...100	Sets the damping amount in the high range
g	[D]Mt.Delay Wet/Dry	Dry, 1:99...99:1, Wet	Sets the multitap delay effect balance
	Src	Off...Tempo	Selects the multitap delay's Wet/Dry modulation source
	Amt	-100...+100	Sets the multitap delay's Wet/Dry modulation amount
h	Routing	Limiter Mt.Delay, Mt.Delay Limiter	Switches the order of the limiter and multitap delay
i	Wet/Dry	Dry, 1:99...99:1, Wet	Balance between the wet and dry signal
	Src	Off...Tempo	Table, "Dynamic Modulation sources," on page 357
	Amt	-100...+100	Amount of modulation source

94: Exciter - Comp (Exciter - Compressor)

This effect combines a mono exciter and a compressor. You can change the order of the effects.

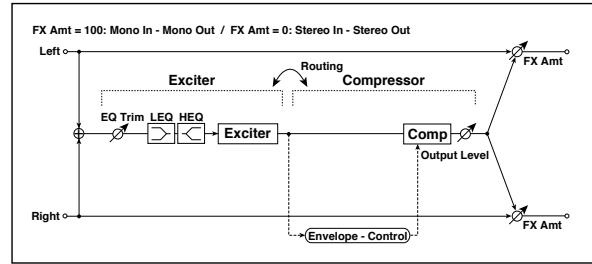

EXCITER			
a	[X]Exciter Blend	-100...+100	Sets the intensity (depth) of the Exciter effect
b	[X]Emphasis Frequency	0...70	Sets the frequency range to be emphasized
c	[X]EQ Trim	0...100	Sets the EQ input level
d	[X]Pre LEQ Gain [dB]	-15...+15	Sets the gain of Low EQ
	Pre HEQ Gain [dB]	-15...+15	Sets the gain of High EQ
COMPRESSOR			
e	[C]Sensitivity	1...100	Sets the sensitivity
f	[C]Attack	1...100	Sets the attack level
	Output Level	0...100	Sets the compressor output level
g	Routing	Exciter Comp, Comp Exciter	Switches the order of the exciter and compressor
h	Wet/Dry	Dry, 1:99...99:1, Wet	Balance between the wet and dry signal
	Src	Off...Tempo	Table, "Dynamic Modulation sources," on page 357
	Amt	-100...+100	Amount of modulation source

95: Exciter - Limiter

This effect combines a mono exciter and a limiter. You can change the order of the effects.

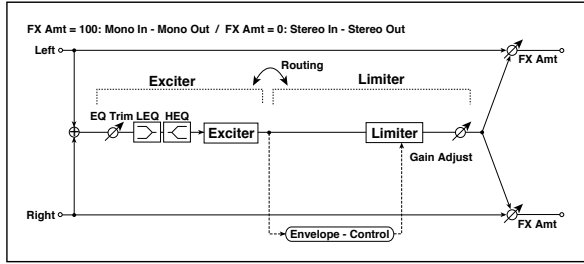

EXCITER			
a	[X]Exciter Blend	-100...+100	Sets the intensity (depth) of the Exciter effect
b	[X]Emphasis Frequency	0...70	Sets the frequency range to be emphasized
c	[X]Trim	0...100	Sets the EQ input level
d	[X]Pre LEQ Gain [dB]	-15...+15	Sets the gain of Low EQ
	Pre HEQ Gain [dB]	-15...+15	Sets the gain of High EQ
LIMITER			
e	[L]Ratio	1.0 : 1... 50.0 : 1, Inf : 1	Sets the signal compression ratio
f	[L]Threshold [dB]	-40...0	Sets the level above which the compressor is applied
g	[L]Attack	1...100	Sets the attack time
	Release	1...100	Sets the release time
h	[L]Gain Adjust [dB]	-Inf, -38...+24	Sets the limiter output gain
i	Routing	Exciter Limiter, Limiter Exciter	Switches the order of the exciter and limiter
j	Wet/Dry	Dry, 1:99...99:1, Wet	Balance between the wet and dry signal
	Src	Off...Tempo	Table, "Dynamic Modulation sources," on page 357
	Amt	-100...+100	Amount of modulation source

96: Exciter - Cho/Flng (Exciter - Chorus/Flanger)

This effect combines a mono limiter and a chorus/flanger.

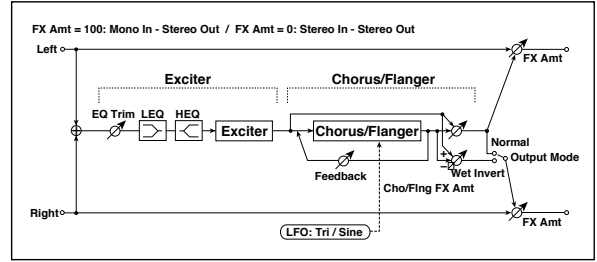

EXCITER			
a	[X]Exciter Blend	-100...+100	Sets the intensity (depth) of the Exciter effect
b	[X]Emphasis Frequency	0...70	Sets the frequency range to be emphasized
c	[X]Trim	0...100	Sets the EQ input level
d	[X]Pre LEQ Gain [dB]	-15...+15	Sets the gain of Low EQ
	Pre HEQ Gain [dB]	-15...+15	Sets the gain of High EQ
CHORUS/FLANGER			
e	[F]LFO Frequency [Hz]	0.02...20.00	Sets the speed of the LFO
	LFO Waveform	Triangle, Sine	Selects the LFO Waveform
f	[F]Delay Time [msec]	0.0...1350.0	Sets the delay time
	Depth	0...100	Sets the depth of LFO modulation
	Feedback	-100...+100	Sets the feedback amount
g	[F]Cho/Flng Wet/Dry	-Wet, -1:99...Dry...99:1, Wet	Sets the effect balance of the chorus/flanger
	Src	Off...Tempo	Selects the Wet/Dry modulation source for the chorus/flanger
	Amt	-100...+100	Sets the Wet/Dry modulation amount for the chorus/flanger
h	[F]Output Mode	Normal, Wet Invert	Selects the output mode for the chorus/flanger
i	Wet/Dry	Dry, 1:99...99:1, Wet	Balance between the wet and dry signal
	Src	Off...Tempo	Table, "Dynamic Modulation sources," on page 357
	Amt	-100...+100	Amount of modulation source

97: Exciter - Phaser

This effect combines a mono limiter and a phaser.

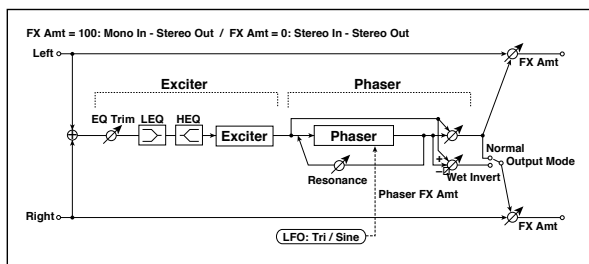

EXCITER			
a	[X]Exciter Blend	-100...+100	Sets the intensity (depth) of the Exciter effect
b	[X]Emphasis Frequency	0...70	Sets the frequency range to be emphasized
c	[X]Trim	0...100	Sets the EQ input level
d	[X]Pre LEQ Gain [dB]	-15...+15	Sets the gain of Low EQ
	Pre HEQ Gain [dB]	-15...+15	Sets the gain of High EQ
PHASER			
e	[P]LFO Frequency [Hz]	0.02...20.00	Sets the speed of the LFO
	LFO Waveform	Triangle, Sine	Selects the LFO Waveform
f	[P]Manual	0...100	Sets the frequency to which the effect is applied
	Depth	0...100	Sets the depth of LFO modulation
	Resonance	-100...+100	Sets the resonance amount
g	[P]Phaser Wet/Dry	-Wet, -1:99...Dry...99:1, Wet	Sets the phaser effect balance
	Src	Off...Tempo	Selects the Wet/Dry modulation source for the phaser
	Amt	-100...+100	Sets the Wet/Dry modulation amount for the phaser
h	[P]Output Mode	Normal, Wet Invert	Selects the phaser output mode
i	Wet/Dry	Dry, 1:99...99:1, Wet	Balance between the wet and dry signal
	Src	Off...Tempo	Table, "Dynamic Modulation sources," on page 357
	Amt	-100...+100	Amount of modulation source

98: Exciter - Mt.Delay (Exciter - Multitap Delay)

This effect combines a mono exciter and a multitap delay.

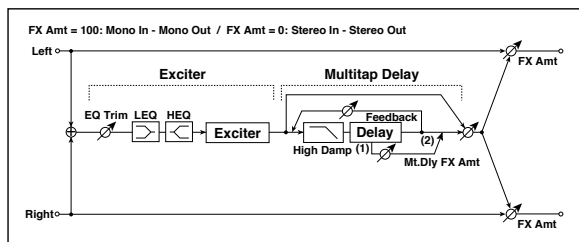

EXCITER			
a	[X]Exciter Blend	-100...+100	Sets the intensity (depth) of the Exciter effect
b	[X]Emphasis Frequency	0...70	Sets the frequency range to be emphasized
c	[X]Trim	0...100	Sets the EQ input level
d	[X]Pre LEQ Gain [dB]	-15...+15	Sets the gain of Low EQ
	Pre HEQ Gain [dB]	-15...+15	Sets the gain of High EQ
MULTITAP DELAY			
e	[D]Tap1 Time [msec]	0.0...1360.0	Sets the Tap1 delay time
	Tap1 Level	0...100	Sets the Tap1 output level
f	[D]Tap2 Time [msec]	0.0...1360.0	Sets the Tap2 delay time
	Feedback (Tap2)	-100...+100	Sets the Tap2 feedback amount
g	[D]High Damp [%]	0...100	Sets the damping amount in the high range
h	[D]Mt.Delay Wet/Dry	Dry, 1:99...99:1, Wet	Sets the multitap delay effect balance
	Src	Off...Tempo	Selects the Wet/Dry modulation source for the multitap delay
	Amt	-100...+100	Sets the Wet/Dry modulation amount for the multitap delay
i	Wet/Dry	Dry, 1:99...99:1, Wet	Balance between the wet and dry signal
	Src	Off...Tempo	Table, "Dynamic Modulation sources," on page 357
	Amt	-100...+100	Amount of modulation source

99: OD/HG - Amp Sim (Overdrive/Hi.Gain - Amp Simulation)

This effect combines a mono overdrive/high-gain distortion and an amp simulation. You can change the order of the effects.

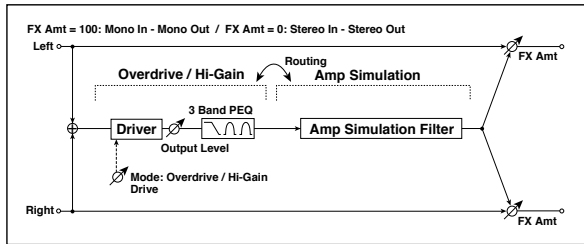

OD/HI-GAIN			
a	[O]Drive Mode	Overdrive, Hi-Gain	Switches between overdrive and high-gain distortion
	Drive	1...100	Sets the degree of distortion
b	[O]Output Level	0...50	Sets the overdrive output level
	Src	Off...Tempo	Selects the modulation source for the overdrive output level
	Amt	-50...+50	Sets the modulation amount of the overdrive output level
e	[O]Low Cutoff [Hz]	20...1.00k	Sets the center frequency for Low EQ (shelving type)
	Gain [dB]	-18...+18	Sets the gain of Low EQ
f	[O]Mid1 Cutoff [Hz]	300...10.00k	Sets the center frequency for Mid/High EQ 1 (peaking type)
	Q	0.5...10.0	Sets the band width of Mid/High EQ 1
	Gain [dB]	-18...+18	Sets the gain of Mid/High EQ 1
g	[O]Mid2 Cutoff [Hz]	500...20.00k	Sets the center frequency for Mid/High EQ 2 (peaking type)
	Q	0.5...10.0	Sets the band width of Mid/High EQ 2
	Gain [dB]	-18...+18	Sets the gain of Mid/High EQ 2
AMP SIM			
h	[A]Amplifier Type	SS, EL84, 6L6	Selects the type of guitar amplifie
i	Routing	OD/HG Amp, Amp OD/HG	Switches the order of the overdrive and amp
j	Wet/Dry	Dry, 1:99...99:1, Wet	Balance between the wet and dry signal
	Src	Off...Tempo	Table, "Dynamic Modulation sources," on page 357
	Amt	-100...+100	Amount of modulation source

100: OD/HG - Cho/Flng (Overdrive/Hi.Gain - Chorus/Flanger)

This effect combines a mono overdrive/high-gain distortion and a chorus/flanger. You can change the order of the effects.

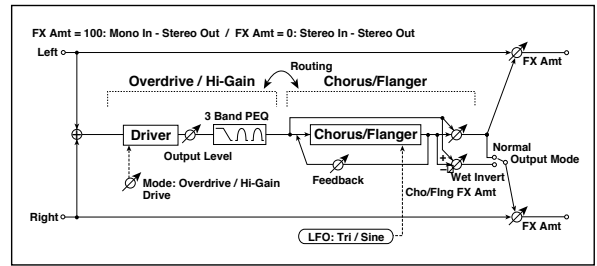

OD/HI-GAIN			
a	[O]Drive Mode	Overdrive, Hi-Gain	Switches between overdrive and high-gain distortion
	Drive	1...100	Sets the degree of distortion
b	[O]Output Level	0...50	Sets the overdrive output level
	Src	Off...Tempo	Selects the modulation source for the overdrive output level
	Amt	-50...+50	Sets the modulation amount of the overdrive output level
e	[O]Low Cutoff [Hz]	20...1.00k	Sets the center frequency for Low EQ (shelving type)
	Gain [dB]	-18...+18	Sets the gain of Low EQ
f	[O]Mid1 Cutoff [Hz]	300...10.00k	Sets the center frequency for Mid/High EQ 1 (peaking type)
	Q	0.5...10.0	Sets the band width of Mid/High EQ 1
	Gain [dB]	-18...+18	Sets the gain of Mid/High EQ 1
g	[O]Mid2 Cutoff [Hz]	500...20.00k	Sets the center frequency for Mid/High EQ 2 (peaking type)
	Q	0.5...10.0	Sets the band width of Mid/High EQ 2
	Gain [dB]	-18...+18	Sets the gain of Mid/High EQ 2
CHORUS/FLANGER			
h	[F]LFO Frequency [Hz]	0.02...20.00	Sets the speed of the LFO
	LFO Waveform	Triangle, Sine	Selects the LFO Waveform
i	[F]Delay Time [msec]	0.0...1350.0	Sets the delay time
	Depth	0...100	Sets the depth of LFO modulation
	Feedback	-100...+100	Sets the feedback amount
j	[F]Cho/Flng Wet/Dry	-Wet, -1:99...99:1, Wet	Sets the effect balance of the chorus/flanger
	Src	Off...Tempo	Selects the Wet/Dry modulation source for the chorus/flanger
	Amt	-100...+100	Sets the Wet/Dry modulation amount for the chorus/flanger
k	[F]Output Mode	Normal, Wet Invert	Selects the output mode for the chorus/flanger
	Routing	OD/HG Flanger, Flanger OD/HG	Switches the order of the overdrive and chorus / flanger
l	Wet/Dry	Dry, 1:99...99:1, Wet	Balance between the wet and dry signal
	Src	Off...Tempo	Table, "Dynamic Modulation sources," on page 357
	Amt	-100...+100	Amount of modulation source

101: OD/HG - Phaser (Overdrive/Hi.Gain - Phaser)

This effect combines a mono overdrive/high-gain distortion and a phaser. You can change the order of the effects.

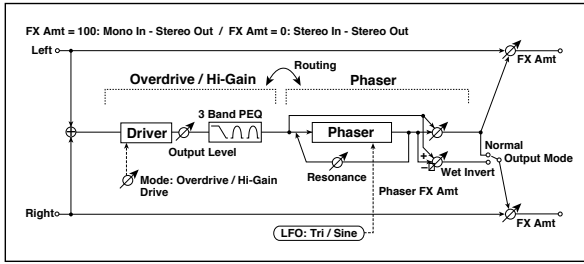

OD/HI-GAIN			
a	[O]Drive Mode	Overdrive, Hi-Gain	Switches between overdrive and high-gain distortion
	Drive	1...100	Sets the degree of distortion
b	[O]Output Level	0...50	Sets the overdrive output level
	Src	Off...Tempo	Selects the modulation source for the overdrive output level
	Amt	-50...+50	Sets the modulation amount of the overdrive output level
e	[O]Low Cutoff [Hz]	20...1.00k	Sets the center frequency for Low EQ (shelving type)
	Gain [dB]	-18...+18	Sets the gain of Low EQ
f	[O]Mid1 Cutoff [Hz]	300...10.00k	Sets the center frequency for Mid/High EQ 1 (peaking type)
	Q	0.5...10.0	Sets the band width of Mid/High EQ 1
	Gain [dB]	-18...+18	Sets the gain of Mid/High EQ 1
g	[O]Mid2 Cutoff [Hz]	500...20.00k	Sets the center frequency for Mid/High EQ 2 (peaking type)
	Q	0.5...10.0	Sets the band width of Mid/High EQ 2
	Gain [dB]	-18...+18	Sets the gain of Mid/High EQ 2
PHASER			
h	[P]LFO Frequency [Hz]	0.02...20.00	Sets the speed of the LFO
	LFO Waveform	Triangle, Sine	Selects the LFO Waveform
i	[P]Manual	0...100	Sets the frequency to which the effect is applied
	Depth	0...100	Sets the depth of LFO modulation
	Resonance	-100...+100	Sets the resonance amount
j	[P]Phaser Wet/Dry	-Wet, -1:99...Dry...99:1, Wet	Sets the phaser effect balance
	Src	Off...Tempo	Selects the Wet/Dry modulation source for the phaser
	Amt	-100...+100	Sets the Wet/Dry modulation amount for the phaser
k	[P]Output Mode	Normal, Wet Invert	Selects the phaser output mode
	Routing	OD/HG, Phaser, OD/HG	Switches the order of the overdrive and phaser
l	Wet/Dry	Dry, 1:99...99:1, Wet	Balance between the wet and dry signal
	Src	Off...Tempo	Table, "Dynamic Modulation sources," on page 357
	Amt	-100...+100	Amount of modulation source

102: OD/HG - Mt.Delay (Overdrive/Hi.Gain - Multitap Delay)

This effect combines a mono overdrive/high-gain distortion and a multitap delay.

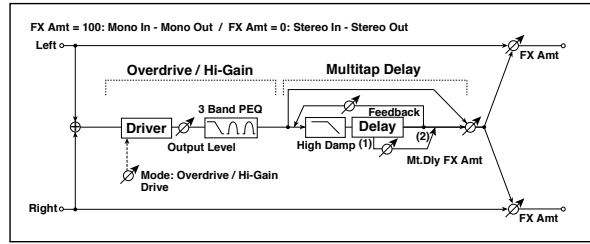

OD/HI-GAIN			
a	[O]Drive Mode	Overdrive, Hi-Gain	Switches between overdrive and high-gain distortion
	Drive	1...100	Sets the degree of distortion
b	[O]Output Level	0...50	Sets the overdrive output level
	Src	Off...Tempo	Selects the modulation source for the overdrive output level
	Amt	-50...+50	Sets the modulation amount of the overdrive output level
e	[O]Low Cutoff [Hz]	20...1.00k	Sets the center frequency for Low EQ (shelving type)
	Gain [dB]	-18...+18	Sets the gain of Low EQ
f	[O]Mid1 Cutoff [Hz]	300...10.00k	Sets the center frequency for Mid/High EQ 1 (peaking type)
	Q	0.5...10.0	Sets the band width of Mid/High EQ 1
	Gain [dB]	-18...+18	Sets the gain of Mid/High EQ 1
g	[O]Mid2 Cutoff [Hz]	500...20.00k	Sets the center frequency for Mid/High EQ 2 (peaking type)
	Q	0.5...10.0	Sets the band width of Mid/High EQ 2
	Gain [dB]	-18...+18	Sets the gain of Mid/High EQ 2
MULTITAP DELAY			
h	[D]Tap1 Time [msec]	0.0...1360.0	Sets the Tap1 delay time
	Tap1 Level	0...100	Sets the Tap1 output level
i	[D]Tap2 Time [msec]	0.0...1360.0	Sets the Tap2 delay time
	Feedback	-100...+100	Sets the Tap2 feedback amount
j	[D]High Damp [%]	0...100	Sets the damping amount in the high range
k	[D]Mt.Delay Wet/Dry	Dry, 1:99...99:1, Wet	Sets the multitap delay effect balance
	Src	Off...Tempo	Selects the Wet/Dry modulation source for the multitap delay
	Amt	-100...+100	Sets the Wet/Dry modulation amount for the multitap delay
l	Wet/Dry	Dry, 1:99...99:1, Wet	Balance between the wet and dry signal
	Src	Off...Tempo	Table, "Dynamic Modulation sources," on page 357
	Amt	-100...+100	Amount of modulation source

103: Wah - Amp Sim (Wah - Amp Simulation)

This effect combines a mono wah and an amp simulation. You can change the order of the effects.

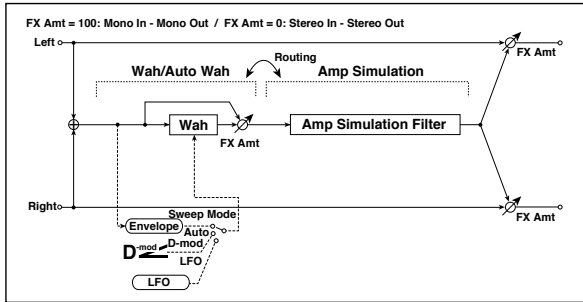

WAH				
a	[W] Frequency Bottom	0...100	Sets the lower limit of the wah center frequency	
	Frequency Top	0...100	Sets the upper limit of the wah center frequency	
b	[W]Sweep Mode	Auto, D-mod, LFO	Selects the control from auto-wah, modulation source, and LFO	
	Src	Off...Tempo	Selects the modulation source for the wah when Sweep Mode=D-mod	
c	[W]LFO Frequency [Hz]	0.02...20.00	Sets the speed of the LFO	
	Resonance	0...100	Sets the resonance amount	
	LPF	Off, On	Switches the wah low pass filter on and off	
d	[W]Wet/Dry	Dry, 1:99...99:1, Wet	Sets the wah effect balance	
	Src	Off...Tempo	Selects the Wet/Dry modulation source for the wah	
	Amt	-100...+100	Sets the Wet/Dry modulation amount for the wah	
AMP SIM				
e	[A]Amplifier Type	SS, EL84, 6L6	Selects the type of guitar amplifier	
f	Routing	Wah Amp, Amp Wah	Switches the order of the wah and amp simulation	
g	Wet/Dry	Dry, 1:99...99:1, Wet	Balance between the wet and dry signal	
	Src	Off...Tempo	Table , "Dynamic Modulation sources," on page 357	
	Amt	-100...+100	Amount of modulation source	

104: Decimator - Amp (Decimator - Amp Simulation)

This effect combines a mono decimator and an amp simulation. You can change the order of the effects.

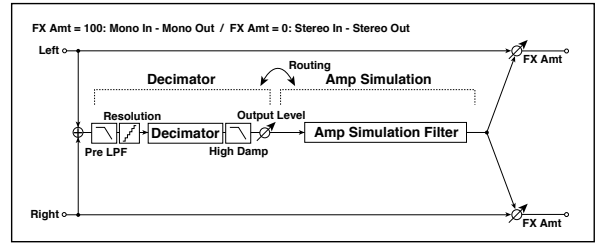

DECIMATOR				
a	[D]Pre LPF	Off, On	Turn the harmonic noise caused by lowered sampling on and off	
	High Damp [%]	0...100	Sets the ratio of high-range damping	
b	[D]Sampling Freq [Hz]	1.00k...48.00k	Sets the sampling frequency	
	Resolution	4...24	Sets the data bit length	
c	[D]Output Level	0...100	Sets the decimator output level	
AMP SIM				
d	[A]Amplifier Type	SS, EL84, 6L6	Selects the type of guitar amplifier	
e	Routing	Decimator Amp, Amp Decimator	Switches the order of the decimator and amp simulation	
f	Wet/Dry	Dry, 1:99...99:1, Wet	Balance between the wet and dry signal	
	Src	Off...Tempo	Table , "Dynamic Modulation sources," on page 357	
	Amt	-100...+100	Amount of modulation source	

105: Decimator - Comp (Decimator - Compressor)

This effect combines a mono decimator and a compressor. You can change the order of the effects.

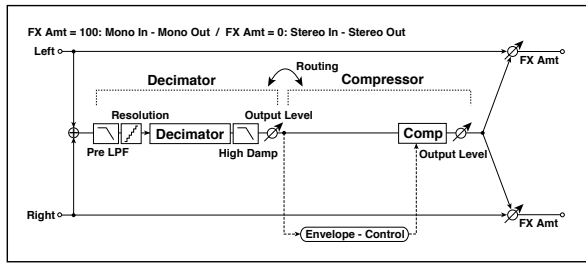

DECIMATOR			
a	[D]Pre LPF	Off, On	Turn the harmonic noise caused by lowered sampling on and off
	High Damp [%]	0...100	Sets the ratio of high-range damping
b	[D]Sampling Freq [Hz]	1.00k...48.00k	Sets the sampling frequency
	Resolution	4...24	Sets the data bit length
c	[D]Output Level	0...100	Sets the decimator output level
COMPRESSOR			
d	[C]Sensitivity	1...100	Sets the sensitivity
e	[C]Attack	1...100	Sets the attack level
	Output Level	0...100	Sets the compressor output level
f	Routing	Decimator Comp, Comp Decimator	Switches the order of the decimator and compressor
g	Wet/Dry	Dry, 1:99...99:1, Wet	Balance between the wet and dry signal
	Src	Off...Tempo	Table, "Dynamic Modulation sources," on page 357
	Amt	-100...+100	Amount of modulation source

106: AmpSim - Tremolo (Amp Simulation- Tremolo)

This effect combines a mono amp simulation and a tremolo.

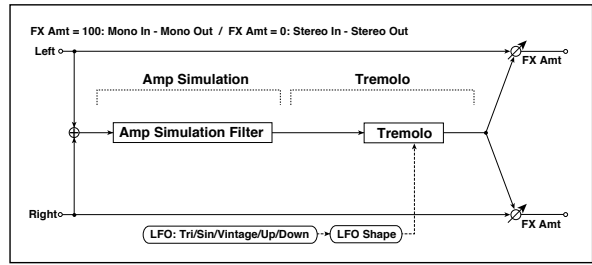

AMP SIM			
a	[A]Amplifier Type	SS, EL84, 6L6	Selects the type of guitar amplifier
TREMLO			
b	[T]LFO Waveform	Triangle, Sine, Vintage, Up, Down	Selects the LFO Waveform
	LFO Shape	-100...+100	Changes the curvature of the LFO Waveform
c	[T]LFO Frequency [Hz]	0.02...20.00	Sets the speed of the LFO
d	[T]Depth	0...100	Sets the depth of LFO modulation
e	Wet/Dry	Dry, 1:99...99:1, Wet	Balance between the wet and dry signal
	Src	Off...Tempo	Table, "Dynamic Modulation sources," on page 357
	Amt	-100...+100	Amount of modulation source

107: Cho/Fng - Mt.Dly (Chorus/Flanger - Multitap Delay)

This effect combines a mono chorus/flanger and a multitap delay.

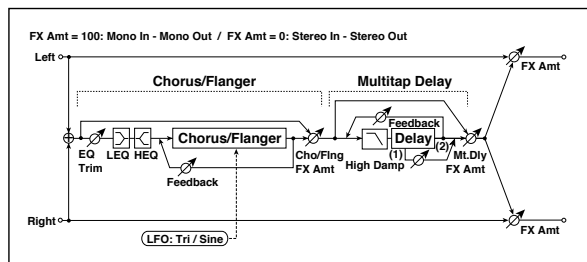

CHORUS/FLANGER			
a	[F]LFO Frequency [Hz]	0.02...20.00	Sets the speed of the LFO
	LFO Waveform	Triangle, Sine	Selects the LFO Waveform
b	[F]Delay Time [msec]	0.0...1350.0	Sets the delay time
	Depth	0...100	Sets the depth of LFO modulation
	Feedback	-100...+100	Sets the feedback amount
c	[F]EQ Trim	0...100	Sets the EQ input level
d	[F]PreLEQ Gain [dB]	-15...+15	Sets the gain of Low EQ
	PreHEQ Gain [dB]	-15...+15	Sets the gain of High EQ
e	[F]Cho/Fng Wet/Dry	-Wet...-1 : 99, Dry, 1 : 99...Wet	Sets the effect balance of the chorus/flanger
MULTITAP DELAY			
a	[D]Tap1 Time [msec]	0.0...1360.0	Sets the Tap1 delay time
	Tap1 Level	0...100	Sets the Tap1 output level
b	[D]Tap2 Time [msec]	0.0...1360.0	Sets the Tap2 delay time
	Feedback	-100...+100	Sets the Tap2 feedback amount
c	[D]High Damp [%]	0...100	Sets the damping amount in the high range
d	[D]Mt.DelayWet/Dry	Dry, 1:99...99:1, Wet	Sets the multitap delay effect balance
	Src	Off...Tempo	Selects the Wet/Dry modulation source for the multitap delay
	Amt	-100...+100	Sets the Wet/Dry modulation amount for the multitap delay
e	Wet/Dry	Dry, 1:99...99:1, Wet	Balance between the wet and dry signal
	Src	Off...Tempo	Table, "Dynamic Modulation sources," on page 357
	Amt	-100...+100	Amount of modulation source

108: Phaser - Cho/Fng (Phaser - Chorus/Flanger)

This effect combines a mono phaser and a chorus/flanger.

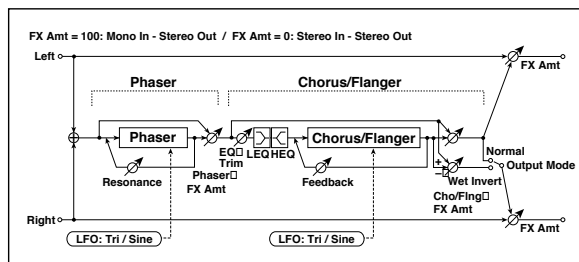

PHASER			
a	[P]LFO Frequency [Hz]	0.02...20.00	Sets the speed of the LFO
	LFO Waveform	Triangle, Sine	Selects the LFO Waveform
b	[P]Manual	0...100	Sets the frequency to which the effect is applied
	Depth	0...100	Sets the depth of LFO modulation
	Resonance	-100...+100	Sets the resonance amount
c	[P]Phaser Wet/Dry	-Wet, -1:99...Dry...99:1, Wet	Sets the phaser effect balance
CHORUS/FLANGER			
d	[F]LFO Frequency [Hz]	0.02...20.00	Sets the speed of the LFO
	LFO Waveform	Triangle, Sine	Selects the LFO Waveform
e	[F]Delay Time [msec]	0.0...1350.0	Sets the delay time
	Depth	0...100	Sets the depth of LFO modulation
	Feedback	-100...+100	Sets the feedback amount
f	[F]EQ Trim	0...100	Sets the EQ input level
g	[F]PreLEQ Gain [dB]	-15...+15	Sets the gain of Low EQ
	PreHEQ Gain [dB]	-15...+15	Sets the gain of High EQ
h	[F]Cho/Fng Wet/Dry	-Wet, -1:99...Dry...99:1, Wet	Sets the effect balance of the chorus/flanger
	Src	Off...Tempo	Selects the Wet/Dry modulation source for the chorus/flanger
	Amt	-100...+100	Sets the Wet/Dry modulation amount for the chorus/flanger
i	[F]Output Mode	Normal, Wet Invert	Selects the output mode for the chorus/flanger
j	Wet/Dry	Dry, 1:99...99:1, Wet	Balance between the wet and dry signal
	Src	Off...Tempo	Table, "Dynamic Modulation sources," on page 357
	Amt	-100...+100	Amount of modulation source

109: Reverb - Gate

This effect combines a mono reverb and a gate.

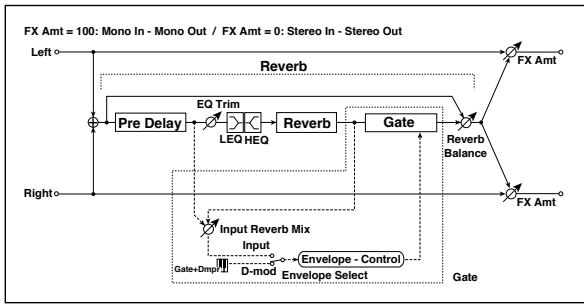

REVERB			
a	[R]Reverb Time [sec]	0.1...10.0	Sets the reverberation time
	High Damp [%]	0...100	Sets the damping amount in the high range
b	[R]Pre Delay [msec]	0...200	Sets the delay time of the reverb sound and gate control signal
	[R]EQ Trim	0...100	Sets the EQ input level
c	Reverb Balance	0...100	Sets the reverb effect balance
	[R]PreLEQ Fc	Low, Mid-Low	Selects the cutoff frequency (low or mid-low) of the low-range equalizer
d	Pre HEQ Fc	High, Mid-High	Selects the cutoff frequency (high or mid-high) of the high-range equalizer
	[R]PreLEQ Gain [dB]	-15.0...+15.0	Sets the gain of Low EQ
e	Pre HEQ Gain [dB]	-15.0...+15.0	Sets the gain of High EQ
	GATE		
f	[G]Envelope Select	D-mod, Input	Switches between modulation source control and input signal control
	Src	Off...Tempo	Selects the modulation source that controls the gate when Envelope Select is set to D-mod
g	[G]Input Reverb Mix	0...100	Sets the balance between the dry and reverb sounds of the gate control signal
	Threshold	0...100	Sets the gate threshold level
h	[G]Polarity	+, -	Switches between non-invert and invert of the gate on/off state
i	[G]Attack	1...100	Sets the attack time
	Release	1...100	Sets the release time
j	Wet/Dry	Dry, 1:99...99:1, Wet	Balance between the wet and dry signal
	Src	Off...Tempo	Table, "Dynamic Modulation sources," on page 357
	Amt	-100...+100	Amount of modulation source

f: [G]Envelope Select

f: Src

g: [G]Input Reverb Mix

g: Threshold

The “[G]Envelope Select” parameter enables you to select whether turning the gate on and off is triggered by the input signal level or controlled directly by the modulation source. You can select from Off to Tempo for the Src parameter to specify the modulation source.

When “[G]Envelope Select” is set to Input, the gate is controlled by the level of signals that are the combination of the dry sound and the reverb sound. When the signal level exceeds the threshold, the gate opens and the reverb sound is output.

Normally, set “[G]Input Reverb Mix” to Dry (the gate is controlled only by the dry sound). If you wish to extend the gate time, set the “[G]Input Reverb Mix” value higher and adjust the “Threshold” value.

Double Size

Double-size effects can only be assigned to the FX2 processors (either in the A or B FX group).

110: St. Mltband Limiter (Stereo Mltband Limiter)

This is a stereo multiband limiter.

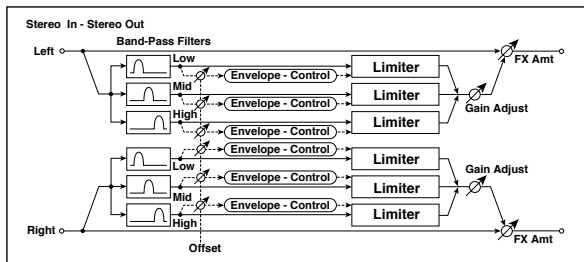

a	Ratio	1.0 : 1 ... 50.0 : 1, Inf : 1	Sets the signal compression ratio	
b	Threshold [dB]	-40...0	Sets the level above which the compressor is applied	
c	Attack	1...100	Sets the attack time	
d	Release	1...100	Sets the release time	
e	Low Offset [dB]	-40...0	Sets the low range gain of trigger signal	
f	Mid Offset [dB]	-40...0	Sets the mid range gain of trigger signal	
g	High Offset [dB]	-40...0	Sets the high range gain of trigger signal	
h	Gain Adjust [dB]	-Inf, -38...+24	Sets the output gain	
	Src	Off...Tempo	Selects the modulation source for the output gain	
	Amt	-63...+63	Sets the modulation amount of the output gain	
i	Wet/Dry	Dry, 1:99...99:1, Wet	Balance between the wet and dry signal	
	Src	Off...Tempo	Table, "Dynamic Modulation sources," on page 357	
	Amt	-100...+100	Amount of modulation source	

111: PianoBody/Damper (PianoBody/Damper Simulation)

This effect simulates the resonance of the piano sound board caused by the string vibration, and also simulates the resonance of other strings that are not being played when you press the damper pedal. It will create a very realistic sound when applied to acoustic piano sounds.

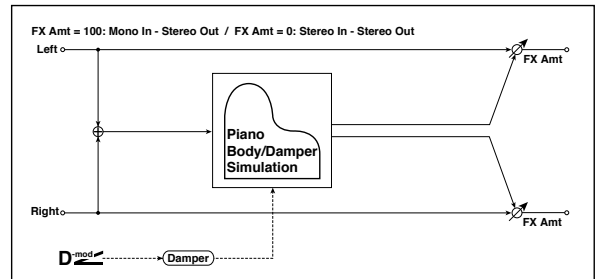

a	Sound Board Depth	0...100	Sets the intensity of resonance of the sound board	
b	Damper Depth	0...100	Sets the intensity of the string resonance created when the damper pedal is pressed	
	Src	Off...Tempo	Selects the modulation source of damper effect	
c	Tone	1...100	Sets tonal quality of effect sound	
d	Mid Shape	0...36	Sets the mid range of tonal quality	
e	Tune	-50...+50	Fine tuning	
f	Wet/Dry	Dry, 1:99...99:1, Wet	Balance between the wet and dry signal	
	Src	Off...Tempo	Table, "Dynamic Modulation sources," on page 357	
	Amt	-100...+100	Amount of modulation source	

a: Sound Board Depth

This parameter sets the intensity of resonance of the piano sound board.

b: Damper Depth

b: Src

This parameter sets the resonance intensity of the other strings created when the damper pedal is pressed. The "Src" parameter selects the modulation source from which the damper effect is applied. Usually, select Damper #64 Pdl (Damper pedal).

MIDI The effect is off when a value for the modulation source specified for the "Src" parameter is 63 or smaller, and the effect is on when the value is 64 or higher.

c: Tone

d: Mid Shape

These parameters control the tonal quality of the effect sound.

e: Tune

Since this effect simulates the resonance of the strings, the sound varies depending on the pitch. If you have changed tuning using the "Master Tuning" (Global > General Controls > Basic), adjust this parameter value.

112: OD/HyperGain Wah (Overdrive/Hyper Gain Wah)

This distortion effect has two modes: overdrive and hyper-gain that produces a strong distortion. A higher high-gain setting is required for this effect relative to a normal-size effect.

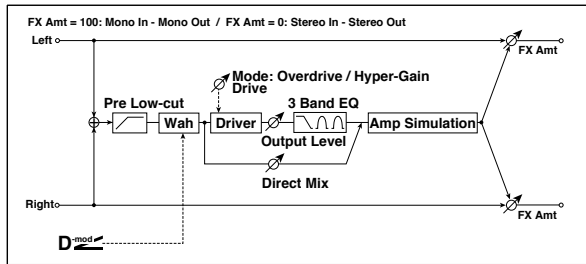

a	Wah	Off, On	Switches Wah on/off
	Src	Off...Tempo	Selects the modulation source that switches the Wah on and off
	Sw	Toggle, Moment	Selects the switching mode for the modulation source that switches the Wah on and off
b	Wah Sweep Range	-10...+10	Sets the range of Wah
	Wah Sweep Src	Off...Tempo	Selects the modulation source that controls the Wah
c	Drive Mode	Overdrive, Hyper-Gain	Switches between overdrive and high-gain distortion
d	Drive	1...120	Sets the degree of distortion
	Pre Low-cut	0...10	Sets the low range cut amount of the distortion input
e	Output Level	0...50	Sets the output level
	Src	Off...Tempo	Selects the modulation source for the output level
	Amt	-50...+50	Sets the modulation amount of the output level
f	Low Cutoff [Hz]	20...1.00k	Sets the center frequency for Low EQ (shelving type)
	Gain [dB]	-18...+18	Sets the gain of Low EQ
g	Mid1 Cutoff [Hz]	300...10.00k	Sets the center frequency for Mid/High EQ 1 (peaking type)
	Q	0.5...10.0	Sets the band width of Mid/High EQ 1
	Gain [dB]	-18...+18	Sets the gain of Mid/High EQ 1
h	Mid2 Cutoff [Hz]	500...20.00k	Sets the center frequency for Mid/High EQ 2 (peaking type)
	Q	0.5...10.0	Sets the band width of Mid/High EQ 2
	Gain [dB]	-18...+18	Sets the gain of Mid/High EQ 2
i	Direct Mix	0...50	Sets the amount of the dry sound mixed to the distortion
	Speaker Simulation	Off, On	Switches the speaker simulation on/off
j	Wet/Dry	Dry, 1:99...99:1, Wet	Balance between the wet and dry signal
	Src	Off...Tempo	Table, "Dynamic Modulation sources," on page 357
	Amt	-100...+100	Amount of modulation source

113: GuitarAmp + P4EQ (Guitar Amp Model + Parametric 4-Band EQ)

This combines a guitar amp simulation (which even faithfully replicates the distortion and tone control circuitry) with a four-band equalizer.

By using this in conjunction with "St. Guitar Cabinet (Stereo Guitar Cabinet)" on page 369, you can obtain an even more realistic guitar sound that simulates a guitar amp + speaker cabinet.

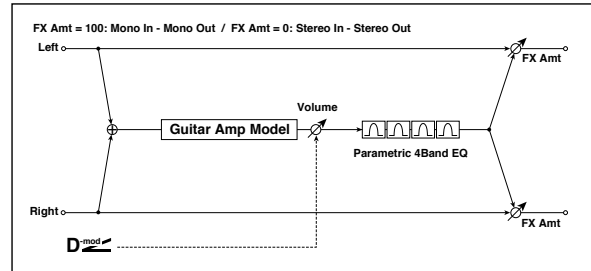

a	Amp Type	VOX AC15, VOX AC15TB, VOX AC30, VOX AC30TB, UK BLUES, UK 70'S, UK 80'S, UK 90'S, UK MODERN, US MODERN, US HIGAIN, BOUTIQUE OD, BOUTIQUE CL, BLACK 2x12, TWEED - 1x12, TWEED - 4x10	Selects the type of the amplifier
	Drive Gain	0...100	Sets the input gain
b	Volume	0...100	Sets the output level
	Src	Off...Tempo	Selects the modulation source for the output level
	Amt	-100...+100	Sets the modulation amount of the output level
c	Bass	0...100	Sets the bass (low range) level
	Middle	0...100	Sets the middle (mid range) level
d	Treble	0...100	Sets the treble (high range) level
	Presence	0...100	Sets the presence (high-frequency tone)
e	Post P4EQ	Thru, On	Selects through or on for the equalizer
e	Band1 Cutoff [Hz]	20...1.00k	Sets the center frequency of Band 1
	Q	0.5...10.0	Sets Band 1's bandwidth
	Gain [dB]	-18...+18	Sets the gain of Band 1
f	Band2 Cutoff [Hz]	50...5.00k	Sets the center frequency of Band 2
	Q	0.5...10.0	Sets Band 2's bandwidth
	Gain [dB]	-18...+18	Sets the gain of Band 2
g	Band3 Cutoff [Hz]	300...10.00k	Sets the center frequency of Band 3
	Q	0.5...10.0	Sets Band 3's bandwidth
	Gain [dB]	-18...+18	Sets the gain of Band 3
h	Band4 Cutoff [Hz]	500...20.00k	Sets the center frequency of Band 4
	Q	0.5...10.0	Sets Band 4's bandwidth
	Gain [dB]	-18...+18	Sets the gain of Band 4
i	Wet/Dry	Dry, 1:99...99:1, Wet	Balance between the wet and dry signal
	Src	Off...Tempo	Table, "Dynamic Modulation sources," on page 357
	Amt	-100...+100	Amount of modulation source

a: Amp Type

d: Presence

If the Amp Type is VOX AC15...VOX AC30TB, this sets the attenuation of the high-frequency range. For other types, this sets the boost of the high-frequency range.

This corresponds to the Cut knob control of amps made by the VOX Corporation.

e: Post P4EQ

By chaining this with 19: St.Guitar Cabinet you can simulate the combination of a guitar amp and speaker cabinet. In this case, we recommend that you set Post P4EQ to “Thru,” but if necessary you can turn it “On” and adjust the tone.

Recommended Combinations of Guitar Amp Models and Cabinet Simulators:

Amp Type	Cabinet Type
VOX AC15	VOX AC15 - 1x12
VOX AC15TB	VOX AC15 - 1x12
VOX AC30	VOX AC30 - 2x12
VOX AC30TB	VOX AC30 - 2x12
UK BLUES	UK H30 - 4x12
UK 70'S	UK H30 - 4x12
UK 80'S	UK T75 - 4x12
UK 90'S	UK T75 - 4x12
UK MODERN	UK T75 - 4x12, US V30 - 4x12
US MODERN	US V30 - 4x12
US HIGAIN	US V30 - 4x12, UK T75 - 4x12
BOUTIQUE OD	UK H30 - 4x12
BOUTIQUE CL	UK H30 - 4x12
BLACK 2x12	BLACK - 2x12
TWEED - 1x12	TWEED - 1x12
TWEED - 4x10	TWEED - 4x10

114: BassTubeAmp+Cab.
(Bass Tube Amp Model + Cabinet)

This simulates a bass amp (with gain and drive) and speaker cabinet.

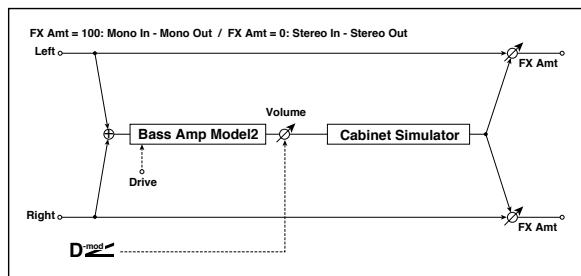

a	Amp Type	STUDIO COMBO VOX AC100 UK MAJOR	Selects the type of the amplifier A tube combo ideal for the Motown sound A 100W tube amp AC100 made by Vox A 200W tube amp made in the UK
b	Drive Gain	0...100	Sets the input gain
c	Volume	0...100	Sets the output level
	Src	Off...Tempo	Selects the modulation source for the output level
	Amt	-100...+100	Sets the modulation amount of the output level
d	Bass	0...100	Sets the bass (low range) level
e	Middle	0...100	Sets the middle (mid range) level
f	Treble	0...100	Sets the treble (high range) level
g	Presence	0...100	Sets the presence (high-frequency tone)
h	Cabinet Simulator	Off, On	Switches the cabinet simulator on/off
i	Cabinet Type	LA - 4x10, MODERN - 4x10, METAL - 4x10, CLASSIC - 8x10, UK - 4x12, STUDIO - 1x15, JAZZ - 1x15, VOX AC100 - 2x15, US - 2x15, UK - 4x15, LA - 1x18, COMBI - 1x12 & 1x18	Selects the cabinet type
j	Wet/Dry	Dry, 1:99...99:1, Wet	Balance between the wet and dry signal
	Src	Off...Tempo	Table, “Dynamic Modulation sources,” on page 357
	Amt	-100...+100	Amount of modulation source

a: Amp Type

i: Cabinet Type

Recommended Combinations of Bass Amp Models and Cabinets:

Amp Type	Cabinet Type
STUDIO COMBO	STUDIO - 1x15
AC100	VOX AC100 - 2x15
UK MAJOR	UK - 4x15, UK - 4x12

115: St. Mic + PreAmp (Stereo Mic Modeling + PreAmp)

This is a stereo mic and preamp simulator (See “Mic Model+PreAmp (Mic Modeling + PreAmp)” on page 372.). For example you might use this to simulate mic'ing of a stereo source such as a rotary speaker.

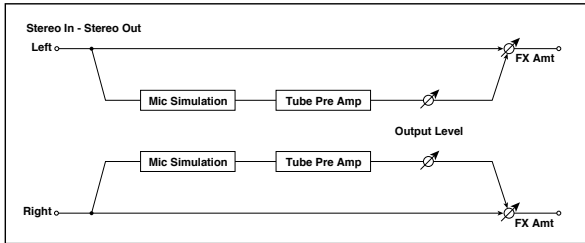

116: Multitap Cho/Delay (Multitap Chorus/Delay)

This effect has six chorus blocks with different LFO phases. You can produce a complex stereo image by setting a different delay time and depth for each block. You can control the delay output level via a modulation source.

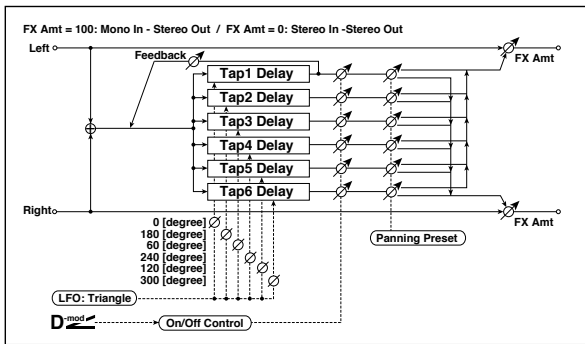

g	Tap6 (300) [msec]	0...2000	Sets the Tap1 (LFO phase=300 degrees) delay time	
	Depth	0...30	Sets the Tap6 chorus depth	
	Status	Always On, Always Off, On Off (Dm), Off On (Dm)	Selects on, off, or modulation source for the control of Tap6 output	
h	Panning Preset	1: L 1 2 3 4 5 6 R, 2: L 1 3 5 2 4 6 R, 3: L 1 3 5 2 4 6 R, 4: L 1 4 5 6 3 2 R	Selects the stereo panning pattern for each tap	
i	Tap1 Feedback	-100...+100	Sets the Tap1 feedback amount	
	Amt	-100...+100	Sets the modulation amount of Tap1 feedback amount	
j	Wet/Dry	Dry, 1:99...99:1, Wet	Balance between the wet and dry signal	
	Amt	-100...+100	Amount of modulation source	

b, c, d, e, f, g: Status

These parameters set the output status of each Tap.

Always On: Output is always on. (No modulation)

Always Off: Output is always off. (No modulation)

Onç Off (dm): Output level is switched from on to off depending on the modulation source.

Offç On (dm): Output level is switched from off to on depending on the modulation source.

Combining these parameters, you can change from 4-phase chorus to two-tap delay by crossfading them gradually via the modulation source during a performance.

h: Panning Preset

This parameter selects combinations of stereo images of the tap outputs.

a	LFO Frequency [Hz]	0.02...13.00	Sets the speed of the LFO	
b	Tap1 (000) [msec]	0...2000	Sets the Tap1 (LFO phase=0 degrees) delay time	
	Depth	0...30	Sets the Tap1 chorus depth	
	Status	Always On, Always Off, On Off (Dm), Off On (Dm)	Selects on, off, or modulation source for the control of Tap1 output	
c	Tap2 (180) [msec]	0...2000	Sets the Tap2 (LFO phase=180 degrees) delay time	
	Depth	0...30	Sets the Tap2 chorus depth	
	Status	Always On, Always Off, On Off (Dm), Off On (Dm)	Selects on, off, or modulation source for the control of Tap2 output	
d	Tap3 (060) [msec]	0...2000	Sets the Tap3 (LFO phase=60 degrees) delay time	
	Depth	0...30	Sets the Tap3 chorus depth	
	Status	Always On, Always Off, On Off (Dm), Off On (Dm)	Selects on, off, or modulation source for the control of Tap3 output	
e	Tap4 (240) [msec]	0...2000	Sets the Tap4 (LFO phase=240 degrees) delay time	
	Depth	0...30	Sets the Tap4 chorus depth	
	Status	Always On, Always Off, On Off (Dm), Off On (Dm)	Selects on, off, or modulation source for the control of Tap4 output	
f	Tap5 (120) [msec]	0...2000	Sets the Tap5 (LFO phase=120 degrees) delay time	
	Depth	0...30	Sets the Tap5 chorus depth	
	Status	Always On, Always Off, On Off (Dm), Off On (Dm)	Selects on, off, or modulation source for the control of Tap5 output	

117: St. Pitch Shifter (Stereo Pitch Shifter)

This is a stereo pitch shifter. The pitch shift amount for the left and right channels can be reversed from each other.

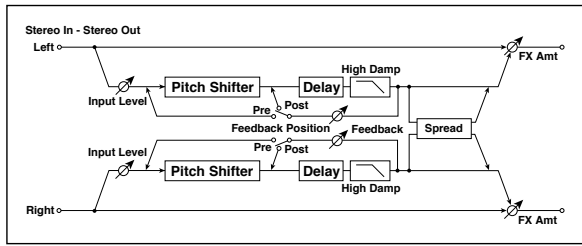

a	Mode	Slow, Medium, Fast	Switches Pitch Shifter mode	
	L/R Pitch	Normal, Up/Down	Determines whether or not the L/R pitch shift amount is inverted	
b	Pitch Shift [1/2tone]	-24...+24	Sets the pitch shift amount in steps of a semitone	
	Src	Off...Tempo	Selects the modulation source of pitch shift amount	
c	Amt	-24...+24	Sets the modulation amount of pitch shift amount	
	Fine [cents]	-100...+100	Sets the pitch shift amount in steps of one cent	
d	Amt	-100...+100	Sets the modulation amount of pitch shift amount	
	L Delay [msec]	0...2000	Sets the delay time for the left channel	
e	R Delay [msec]	0...2000	Sets the delay time for the right channel	
	Feedback	-100...+100	Sets the feedback amount	
f	High Damp [%]	0...100	Sets the damping amount in the high range	
	Feedback Position	Pre, Post	Switches the feedback connection	
g	Spread	-100...+100	Sets the width of the stereo image of the effect sound	
	Input Level Dmod [%]	-100...+100	Sets the modulation amount of the input level	
h	Src	Off...Tempo	Selects the modulation source for the input level	
	Wet/Dry	Dry, 1:99...99:1, Wet	Balance between the wet and dry signal	
i	Src	Off...Tempo	Table, "Dynamic Modulation sources," on page 357	
	Amt	-100...+100	Amount of modulation source	

a: L/R Pitch

When you select Up/Down for this parameter, the pitch shift amount for the right channel will be reversed. If the pitch shift amount is positive, the pitch of the left channel is raised, and the pitch of the right channel is lowered.

118: St. PitchShift BPM (Stereo Pitch Shifter BPM)

This stereo pitch shifter enables you to set the delay time to match the song tempo.

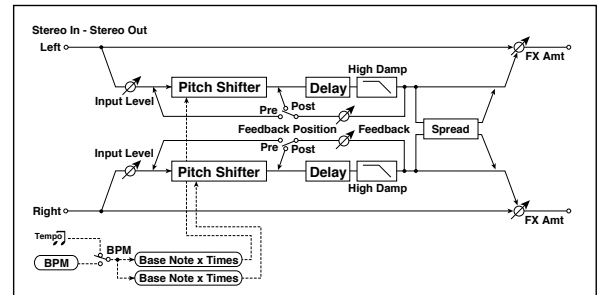

a	Mode	Slow, Medium, Fast	Switches Pitch Shifter mode	
	L/R Pitch	Normal, Up/Down	Determines whether or not the L/R pitch shift amount is inverted	
b	Pitch Shift [1/2tone]	-24...+24	Sets the pitch shift amount in steps of a semitone	
	Src	Off...Tempo	Selects the modulation source of pitch shift amount	
c	Amt	-24...+24	Sets the modulation amount of pitch shift amount	
	Fine [cents]	-100...+100	Sets the pitch shift amount in steps of one cent	
d	Amt	-100...+100	Sets the modulation amount of pitch shift amount Sets the modulation amount of pitch shift amount	
	BPM	MIDI, 40.00...300.00	MIDI syncs to the system tempo; 40-300 sets the tempo manually for this individual effect	
e	Time Over? L	---, OVER!	Display the error message if the left channel delay time exceeds the upper limit	
	R	---, OVER!	Display the error message if the right channel delay time exceeds the upper limit	
f	L Delay Base Note	r...w	Selects the type of notes to specify the left channel delay time	
	Times	x1...x32	Sets the number of notes to specify the left channel delay time	
g	R Delay Base Note	r...w	Selects the type of notes to specify the right channel delay time	
	Times	x1...x32	Sets the number of notes to specify the right channel delay time	
h	Feedback Position	Pre, Post	Switches the feedback connection	
	Spread	-100...+100	Sets the width of the stereo image of the effect sound	
i	Feedback	-100...+100	Sets the feedback amount	
	High Damp [%]	0...100	Sets the damping amount in the high range	
j	Input Level Dmod [%]	-100...+100	Sets the modulation amount of the input level	
	Src	Off...Tempo	Selects the modulation source for the input level	
k	Wet/Dry	Dry, 1:99...99:1, Wet	Balance between the wet and dry signal	
	Src	Off...Tempo	Table, "Dynamic Modulation sources," on page 357	
l	Amt	-100...+100	Amount of modulation source	

119: Rotary SpeakerOD (Rotary Speaker Overdrive)

This is a stereo rotary speaker effect. It has an internal speaker simulator that simulates overdrive (recreating the amp distortion) and characteristics of the rotary speaker, producing a very realistic rotary speaker sound.

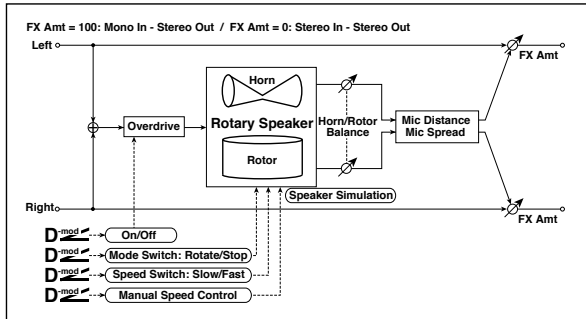

a	Overdrive	Off, On	Switches overdrive on/off
	Src	Off...Tempo	Selects a modulation source to switch overdrive on/off
	Sw	Toggle, Moment	Sets the switch mode for overdrive on/off modulation
b	Overdrive Gain	0...100	Determines the degree of distortion
	Overdrive Level	0...100	Sets the overdrive output level
c	Overdrive Tone	0...15	Sets the tonal quality of the overdrive
	Speaker Simulator	Off, On	Switches the speaker simulation on/off
d	Mode Switch	Rotate, Stop	Switches between speaker rotation and stop
	Src	Off...Tempo	Selects a modulation source for Rotate/Stop
	Sw	Toggle, Moment	Sets the switch mode for Rotate/Stop modulation
e	Speed Switch	Slow, Fast	Switches the speaker rotation speed between slow and fast
	Src	Off...Tempo	Selects a modulation source for Slow/Fast
	Sw	Toggle, Moment	Sets the switch mode for Slow/Fast modulation
f	Horn/Rotor Balance	Rotor, 1...99, Horn	Sets the volume balance between the high-range horn and low-range rotor
	Manual SpeedCtrl	Off...Tempo	Sets a modulation source for direct control of rotation speed
g	Horn Acceleration	0...100	Sets how quickly the horn rotation speed changes
	Horn Ratio	Stop, 0.50...2.00	Adjusts the (high-frequency) horn rotation speed. Standard value is 1.00. "Stop" stops the rotation
h	Rotor Acceleration	0...100	Sets how quickly the rotor speed changes
	Rotor Ratio	Stop, 0.50...2.00	Adjusts the (low-frequency) rotor rotation speed. Standard value is 1.0. "Stop" stops the rotation
i	Mic Distance	0...100	Distance between the microphone and rotary speaker
	Mic Spread	0...100	Angle of left and right microphones
j	Wet/Dry	Dry, 1:99...99:1, Wet	Balance between the wet and dry signal
	Src	Off...Tempo	Table, "Dynamic Modulation sources," on page 357
	Amt	-100...+100	Amount of modulation source

a: Sw

This parameter determines how to switch on/off the overdrive via a modulation source.

When "Sw" = Toggle, overdrive is turned on/off each time the pedal or joystick is operated.

MDI Overdrive will be switched on/off each time the value of the modulation source exceeds 64.

When "Sw" = Moment, overdrive is applied only when you press the pedal or operate the joystick.

MDI Only when the value for the modulation source is 64 or higher, the overdrive effect is applied.

120: L/C/R Long Delay

This multitap delay outputs three Tap signals to left, right and center respectively. You can set a maximum of 5,460msec for the delay time.

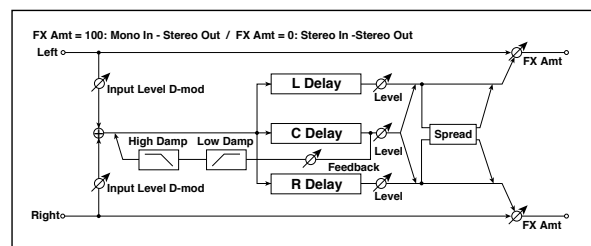

a	L Delay Time [msec]	0...5460	Sets the delay time of TapL
	Level	0...50	Sets the output level of TapL
b	C Delay Time [msec]	0...5460	Sets the delay time of TapC
	Level	0...50	Sets the output level of TapC
c	R Delay Time [msec]	0...5460	Sets the delay time of TapR
	Level	0...50	Sets the output level of TapR
d	Feedback (C Delay)	-100...+100	Sets the feedback amount of TapC
	Src	Off...Tempo	Selects the modulation source for the TapC feedback
	Amt	-100...+100	Sets the modulation amount of the TapC feedback
e	High Damp [%]	0...100	Sets the damping amount in the high range
	Low Damp [%]	0...100	Sets the damping amount in the low range
f	Input Level Dmod [%]	-100...+100	Sets the modulation amount of the input level
	Src	Off...Tempo	Selects the modulation source for the input level
g	Spread	0...50	Sets the width of the stereo image of the effect sound
h	Wet/Dry	Dry, 1:99...99:1, Wet	Balance between the wet and dry signal
	Src	Off...Tempo	Table, "Dynamic Modulation sources," on page 357
	Amt	-100...+100	Amount of modulation source

121: St/Cross Long Delay (Stereo/Cross Long Delay)

This is a stereo delay, and can be used as a cross-feedback delay effect in which the delay sounds cross over between left and right by changing the feedback routing. You can set a maximum of 2,730msec for the delay time.

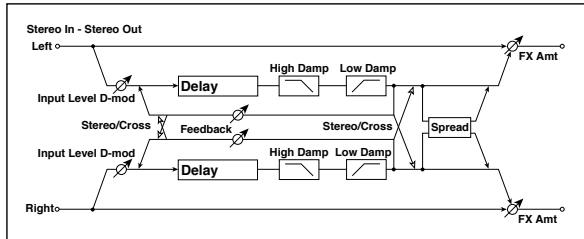

a	Stereo/Cross	Stereo, Cross	Switches between stereo delay and cross-feedback delay	
b	L Delay Time [msec]	0.0...2730.0	Sets the delay time for the left channel	
c	R Delay Time [msec]	0.0...2730.0	Sets the delay time for the right channel	
d	L Feedback	-100...+100	Sets the feedback amount for the left channel	
	Src	Off...Tempo	Selects the modulation source of feedback amount	
	Amt	-100...+100	Sets the modulation amount of the left channel feedback	
e	R Feedback	-100...+100	Sets the feedback amount for the right channel	
	Amt	-100...+100	Sets the modulation amount of the right channel feedback	
f	High Damp [%]	0...100	Sets the damping amount in the high range	
g	Low Damp [%]	0...100	Sets the damping amount in the low range	
h	Input Level Dmod [%]	-100...+100	Sets the modulation amount of the input level	
	Src	Off...Tempo	Selects the modulation source for the input level	
i	Spread	-50...+50	Sets the width of the stereo image of the effect sound	
j	Wet/Dry	Dry, 1:99...99:1, Wet	Balance between the wet and dry signal	
	Src	Off...Tempo	Table, "Dynamic Modulation sources," on page 357	
	Amt	-100...+100	Amount of modulation source	

122: Hold Delay

This effect records the input signal and plays it back repeatedly. You can control the start of recording and reset via a modulation source. Easy to use for real-time performances.

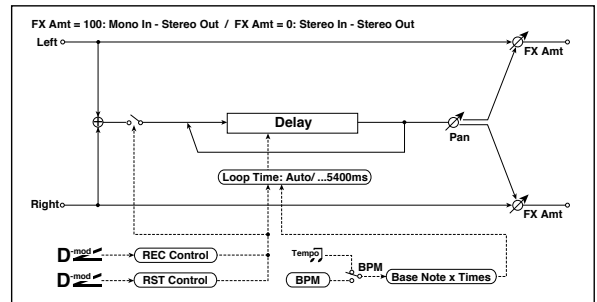

a	Loop Time [msec]	Auto, 1...10800	Sets Automatic loop time setup mode or specifies loop time	
b	Loop BPM Sync	Off, On	Specifies whether delay time is set in milliseconds, or as a note value relative to tempo	ABX
c	BPM	MIDI, 40.00...300.00	MIDI syncs to the system tempo; 40-300 sets the tempo manually for this individual effect	
	Time Over?	---, OVER!	An error indication that appears if delay time exceeds the upper limit when MIDI/Tempo Sync=On	
d	Loop Base Note	r...w	Selects the type of notes to specify the delay time	
	Times	x1...x32	Sets the number of notes to specify the delay time	
e	REC Control Src	Off...Tempo	Selects control source for recording	
f	RST Control Src	Off...Tempo	Selects control source for reset	
g	Manual REC Control	REC Off, REC On	Sets the recording switch	
h	Manual RST Control	Off, RESET	Sets the reset switch	
i	Pan	L100...L1, C, R1...R100	Sets the stereo image of the effect	
	Src	Off...Tempo	Selects the modulation source of stereo image of the effect	
	Amt	-100...+100	Sets the modulation amount of stereo image of the effect	
j	Wet/Dry	Dry, 1:99...99:1, Wet	Balance between the wet and dry signal	
	Src	Off...Tempo	Table, "Dynamic Modulation sources," on page 357	
	Amt	-100...+100	Amount of modulation source	

a: Loop Time [msec]

With Auto, the loop time is automatically set. Otherwise, you can specify the loop time.

When Auto is selected, the Loop Time is automatically set to the time it takes for a performance recorded while the Modulation Source or "Manual REC Control" is on. However, if the time length exceeds 10,800msec, the loop time will be automatically set to 10,800msec.

c: Time Over?

You can set the delay time up to 10,800msec. If the delay time exceeds this limit, the error message "OVER!" appears in the display. Set the delay time parameters so that this message will not appear. "Time Over?" is only a display parameter.

b: Loop BPM Sync

c: BPM

d: Loop Base Note

d: Times

If "Loop BPM Sync" is on, the "Times" setting is ignored; the loop time is determined by "BPM," "Loop Base Note," and

“Times.” Even in this case, the delay time cannot exceed 10,800 msec.

“Hold” procedure (when Loop Time = Auto)

1. “Rec Src”JS +Y: #01
 “Reset Src”JS -Y: #02
 “Manual REC Control”REC Off
 “Manual RST Control”RESET
 “Loop Time [msec]”Auto
 “MIDI/Tempo Sync”Off
 It should be noted that all recordings will be deleted while Reset is On.
2. “Manual RST Control”Off
 Reset is cancelled and the unit enters Rec ready mode.
3. Push the joystick in the +Y direction (forward) and play a phrase you wish to hold. When you pull the joystick to its original position, the recording will be finished and the phrase you just played will be held.
 Loop Time is automatically set only for the first recording after resetting. If the time length exceeds 10,800msec, Loop Time will be automatically set to 10,800msec. (If you have set “Times” to 1–10,800msec, the specified loop time will be used regardless of the time taken from pushing the joystick forward until it is pulled back. However, the recording method remains the same. The phrase being played while the joystick is pushed forward will be held.)
4. If you made a mistake during recording, pull the joystick in the -Y direction (back) to reset. In this way, the recording will be erased. Repeat step 4. again.
5. The recorded phrase will be repeated again and again. You can use this to create an accompaniment.
6. By pushing the joystick in the +Y direction (forward), you can also overdub performances over the phrase that is being held.

e: REC Control Src

g: Manual REC Control

“REC Control Src” selects the modulation source that controls recording.

If this modulation is on, or if “Manual REC Control” is set to On, you can record the input signal. If a recording has already been carried out, additional signals will be overdubbed.

MIDI The effect is off when a value for the modulation source specified for the “REC Control Src” parameter is 63 or smaller, and the effect is on when the value is 64 or higher.

f: RST Control Src

h: Manual RST Control

The “RST Control Src” parameter specifies the modulation source that controls the reset operation.

When you set this modulation source to On, or “Manual RST Control” to RESET, you can erase what you recorded. If the Loop Time parameter has been set to Auto, the loop time is also reset.

MIDI The effect is off when a value for the modulation source specified for the “RST Control Src” parameter is 63 or smaller, and the effect is on when the value is 64 or higher.

123: LCR BPM Long Dly

The L/C/R delay enables you to match the delay time with the song tempo.

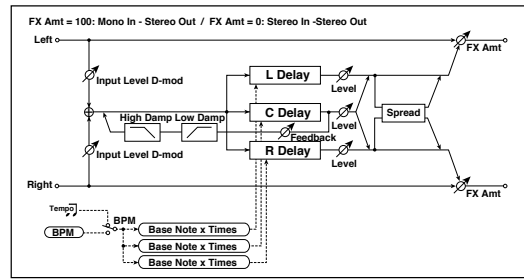

a	BPM	MIDI, 40.00... 300.00	MIDI syncs to the system tempo; 40–300 sets the tempo manually for this individual effect	
	Time Over?	---, OVER!	Displays an error message when the delay time exceeds the upper limit	
b	L Delay Base Note	r...w	Selects the type of notes to specify the delay time for TapL	
	Times	x1...x32	Sets the number of notes to specify the delay time for TapL	
	Level	0...50	Sets the output level of TapL	
c	C Delay Base Note	r...w	Selects the type of notes to specify the delay time for TapC	
	Times	x1...x32	Sets the number of notes to specify the delay time for TapC	
	Level	0...50	Sets the output level of TapC	
d	R Delay Base Note	r...w	Selects the type of notes to specify the delay time for TapR	
	Times	x1...x32	Sets the number of notes to specify the delay time for TapR	
	Level	0...50	Sets the output level of TapR	
e	Feedback (C Delay)	-100...+100	Sets the feedback amount of TapC	
	Src	Off...Tempo	Selects the modulation source for the TapC feedback	
	Amt	-100...+100	Sets the modulation amount of the TapC feedback	
f	High Damp [%]	0...100	Sets the damping amount in the high range	
	Low Damp [%]	0...100	Sets the damping amount in the low range	
g	Input Level Dmod [%]	-100...+100	Sets the modulation amount of the input level	
	Src	Off...Tempo	Selects the modulation source for the input level	
h	Spread	0...50	Sets the width of the stereo image of the effect sound	
i	Wet/Dry	Dry, 1:99...99:1, Wet	Balance between the wet and dry signal	
	Src	Off...Tempo	Table “Dynamic Modulation sources,” on page 357	
	Amt	-100...+100	Amount of modulation source	

a: Time Over?

You can set the delay time up to 10,920msec. If the delay time exceeds this limit, the error message “OVER!” appears in the display. Set the delay time parameters so that this message will not appear. “Time Over?” is only a display parameter.

124: St. BPM Long Dly (Stereo BPM Long Delay)

The stereo delay enables you to match the delay time with the song tempo.

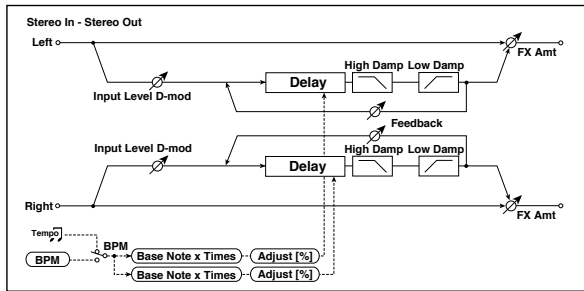

a	BPM	MIDI, 40.00...300.00	MIDI syncs to the system tempo; 40–300 sets the tempo manually for this individual effect	
	Time Over? L	---, OVER!	Display the error message if the left channel delay time exceeds the upper limit	
	R	---, OVER!	Display the error message if the right channel delay time exceeds the upper limit	
b	L Delay Base Note	r...w	Selects the type of notes to specify the left channel delay time	
	Times	x1...x32	Sets the number of notes to specify the left channel delay time	
	Adjust [%]	-2.50...+2.50	Fine-adjust the left channel delay time	
c	R Delay Base Note	r...w	Selects the type of notes to specify the right channel delay time	
	Times	x1...x32	Sets the number of notes to specify the right channel delay time	
	Adjust [%]	-2.50...+2.50	Fine-adjust the right channel delay time	
d	L Feedback	-100...+100	Sets the feedback amount for the left channel	
	Src	Off...Tempo	Selects the modulation source of feedback amount	
	L Amt	-100...+100	Sets the modulation amount of the left channel feedback	
e	R Feedback	-100...+100	Sets the feedback amount for the right channel	
	R Amt	-100...+100	Sets the modulation amount of the right channel feedback	
f	High Damp [%]	0...100	Sets the damping amount in the high range	
g	Low Damp [%]	0...100	Sets the damping amount in the low range	
h	Input Level Dmod [%]	-100...+100	Sets the modulation amount of the input level	
	Src	Off...Tempo	Selects the modulation source for the input level	
	Wet/Dry	Dry, 1:99...99:1, Wet	Balance between the wet and dry signal	
i	Src	Off...Tempo	Table, "Dynamic Modulation sources," on page 357	
	Amt	-100...+100	Amount of modulation source	

a: Time Over? L, R

You can set the delay time up to 5,460msec. If the delay time exceeds this limit, the error message "OVER!" appears in the display. Set the delay time parameters so that this message will not appear. "Time Over?" is only a display parameter.

125: Early Reflections

This early reflection effect has more precise early reflections with twice the maximum length of a normal-size effect (See "Early Reflections" on page 401.). You can create a very smooth and dense sound.

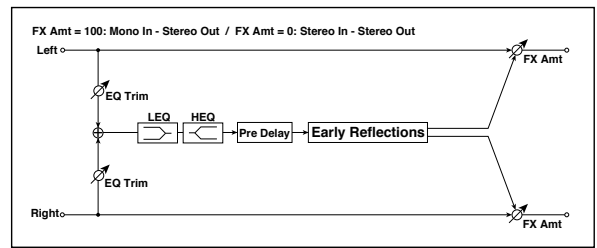

a	Type	Sharp, Loose, Modulated, Reverse	Selects the decay curve for the early reflection	
b	ER Time [msec]	10...1600	Sets the time length of early reflection	
c	Pre Delay [msec]	0...200	Sets the time taken from the original sound to the first early reflection	
d	EQ Trim	0...100	Sets the input level of EQ applied to the effect sound	
e	Pre LEQ Fc	Low, Mid-Low	Selects the cutoff frequency (low or mid-low) of the low-range equalizer	
	Pre HEQ Fc	High, Mid-High	Selects the cutoff frequency (high or mid-high) of the high-range equalizer	
f	Pre LEQ Gain [dB]	-15.0...+15.0	Sets the gain of Low EQ	
	Pre HEQ Gain [dB]	-15.0...+15.0	Sets the gain of High EQ	
g	Wet/Dry	Dry, 1:99...99:1, Wet	Balance between the wet and dry signal	
	Src	Off...Tempo	Table, "Dynamic Modulation sources," on page 357	
	Amt	-100...+100	Amount of modulation source	

Installing the Korg USB MIDI Driver

The USB Device port can be used to transfer MIDI data between the Pa900 and a personal computer (this is called the *MIDI Over USB* function). This is useful when your computer is not fitted with a MIDI interface.

USB can be used in parallel with the MIDI ports. For example, you can connect your Pa900 to a sequencer running on your computer, and at the same time control another MIDI instrument connected to the MIDI ports of Pa900.

Connecting Pa900 this way makes it, at the same time, a MIDI input device, a controller, and a sound generator.

Connecting Pa900 to a personal computer

Please install the KORG USB-MIDI Driver, before connecting Pa900 to a personal computer. Be sure your personal computer meets the requirement shown on “KORG USB-MIDI Driver system requirements” below.

KORG USB-MIDI Driver system requirements

Windows

Computer: A computer with an USB port, that satisfies the requirements of Microsoft Windows XP, Vista or 7.

Operating system: Microsoft Windows XP Home Edition / Professional / x64 Edition (a driver for the x64 Edition is in beta release), Vista, 7.

Macintosh

Computer: An Apple Macintosh with an USB port that satisfies the requirements of Mac OS X.

Operating system: Mac OS X version 10.3 or later.

Please note before use

Copyright to all software included in this product is the property of Korg Inc.

The license agreement for this software is provided separately. You must read this license agreement before you install this software. Your installation of this software will be taken to indicate your acceptance of this agreement.

Windows: Installing the KORG USB-MIDI Driver

Please connect Pa900 to the computer via an USB cable only after having installed the KORG USB-MIDI Driver Tools.

1. Insert the included Accessory DVD into the optical drive of your Windows PC.
2. Open the folder DVD-ROM\USB-MIDI Driver\Win - KORG USB-MIDI Driver v.n.nn\ and double-click on “KORG USB-MIDI Driver Tools Setup v.n.nn.exe” to run the installer (“n.nn” meaning the version number).
3. Follow the instructions appearing on screen. At the end, the tools will be installed.
4. When installation is completed, connect the DEVICE USB port of your Pa900 to one of the USB ports of your Windows PC by using a standard USB cable. The Auto Installer will immediately start.
5. When finished, the USB-MIDI driver will be installed, and Pa900 will be able to communicate with your computer via USB.

You can access the tools and manuals from the Start menu.

6. Restart the computer, and turn on Pa900. Connect Pa900 to the computer via an USB cable.
7. Select the following command from the task bar to open the installation instructions:
Start > all programs > KORG > KORG USB-MIDI Driver Tools > Installation manual
8. Select the following command from the task bar to open the installation program:
Start > all programs > KORG > KORG USB-MIDI Driver Tools > Install KORG USB-MIDI Device
9. Please follow the installation instructions appearing on-screen to install the KORG USB-MIDI Driver.

Driver's ports

After installation, the following ports will be shown in your MIDI application (e.g., sequencer) among the other MIDI devices:

Pa900 KEYBOARD: This allows for reception of MIDI messages from the Pa900 (keyboard and controller's data) to the MIDI application running on the computer.

Pa900 SOUND: This allows for transmission of MIDI messages from the MIDI application running on the computer, to the internal tone generator of Pa900.

Mac OS X: Installing the KORG USB-MIDI Driver

1. Insert the included Accessory DVD into the optical drive of your Mac.
2. If the DVD content does not appear on screen, double-click the DVD icon to open a window in the Finder.
3. Open the folder /USB-MIDI Driver/Mac - KORG USB-MIDI Driver v.n.nn/ and double-click on “KORG USB-MIDI Driver v.n.n.n.dmg” to open a virtual drive in the Finder (“n.n.n” meaning the version number).
4. Double-click on “KORG USB-MIDI Driver.pkg” to run the installer.
5. Follow the instructions appearing on screen.
6. When installation is completed, eject the virtual drive, and connect the DEVICE USB port of your Pa900 to one of the USB ports of your Mac by using a standard USB cable.

Driver's ports

After installation, the following ports will be shown in your MIDI application (e.g., sequencer) among the other MIDI devices:

Pa900 KEYBOARD: This allows for reception of MIDI messages from Pa900 (keyboard and controller's data) to the MIDI application running on the Mac.

Pa900 SOUND: This allows for transmission of MIDI messages from the MIDI application running on the Mac, to the internal tone generator of Pa900.

MIDI Data

MIDI Controllers

The following is a table including all Control Change messages, and their effect on various Pa900 functions. Note that not all controllers are available in all operative modes.

CC#	CC Name	Pa900 Function
0	Bank Select	Sound selection
1	Mod1 (Y+)	Joystick forward
2	Mod2 (Y-)	Joystick backward
3	Undef. ctl	
4	Foot ctl	
5	Port.time	
6	Data ent.	
7	Volume	Track volume
8	Balance	
9	Undef. ctl	
10	Pan Pot	Track panning
11	Expression	Expression
12	Fx Ctl 1	CC#12
13	Fx Ctl 2	CC#13
14-15	Undef. ctl p	
16	Gen.pc.1	
17	Gen.pc.2	
18	Slider	
19	Gen.pc.4	
20-31	Undef. ctl pp	
Control Change #32-63 are the LSB (Least Significant Byte) of Control Change #0-31, i.e. the MSB (Most Significant Byte), and are changed according to their MSB counterparts.		
64	Damper	Damper pedal
65	Portamento	
66	Sostenuto	Sostenuto pedal
67	Soft	Soft pedal
68	Legato	
69	Hold 2	
70	Sustain level	
71	F.Res.Hp	Filter resonance
72	Release	Release time
73	Attack	Attack time
74	F.CutOff	Filter cutoff (Brilliance)
75	Decay T.	Decay time
76	Lfo1 Sp.	Vibrato speed
77	Lfo1 Dpt	Vibrato depth
78	Lfo1 Dly	Vibrato initial delay
79	FilterEgpb	
80	Gen.pc.5	Sound Controller 1
81	Gen.pc.6	Sound Controller 2
82	Gen.pc.7	
83	Gen.pc.8	
84	Port.ctl	
85-90	Undef. ctl	

CC#	CC Name	Pa900 Function
91	Fx 1 depth	A/B Master FX 1 (reverb) send level
92	Fx 2 ctl	
93	Fx 3 depth	A/B Master FX 2 (modul.) send level
94	Fx 4 ctl	
95	Fx 5 ctl	
96	Data Inc	
97	Data Dec	
98	NRPN Lsb	See table below ^(*)
99	NRPN Msb*	See table below ^(*)
100	RPN Lsb	See MIDI Implementation Chart
101	RPN Msb	See MIDI Implementation Chart
102-119	Undefined ctl	
120	AllSOFF	
121	Res Ctl	Reset All Controllers
122	LocalCt	
123	NoteOff	
124	Omnioff	
125	OmnioN	
126	Mono On	
127	Poly On	

(*) The following NRPN messages are recognized by Pa900 in Song Play and Sequencer mode only:

NRPN	CC#99 (MSB)	CC#98 (LSB)	CC#06 (Data Entry)
Vibrato Rate	1	8	0...127 ^(a)
Vibrato Depth	1	9	0...127 ^(a)
Vibrato Decay	1	10	0...127 ^(a)
Filter Cutoff	1	32	0...127 ^(a)
Resonance	1	33	0...127 ^(a)
EG Attack Time	1	99	0...127 ^(a)
EG Decay Time	1	100	0...127 ^(a)
EG Release Time	1	102	0...127 ^(a)
Drum Filter Cutoff	20	dd ^(b)	0...127 ^(a)
Drum Filter Resonance	21	dd ^(b)	0...127 ^(a)
Drum EG Attack Time	22	dd ^(b)	0...127 ^(a)
Drum EG Decay Time	23	dd ^(b)	0...127 ^(a)
Drum Coarse Tune	24	dd ^(b)	0...127 ^(a)
Drum Fine Tune	25	dd ^(b)	0...127 ^(a)
Drum Volume	26	dd ^(b)	0...127
Drum Panpot	28	dd ^(b)	0...127 ^(a)
Drum Rev Send (FX 1)	29	dd ^(b)	0...127 ^(a)
Drum Mod Send (FX 2)	30	dd ^(b)	0...127 ^(a)

(a). 64 = No change to the original parameter's value
 (b). dd = Drum Instrument No. 0...127 (C0...C8)

Note: These controls are reset when stopping the Song, or choosing a new Song.

Recognized chords

The following pages show the most important chords recognized by the Pa900, when the selected Chord Recognition mode is Fingered (see “Chord Recognition” on page 252 of the User’s Manual).

Major

3-note

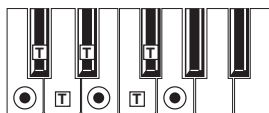

2-note

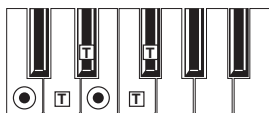

Major 6th

4-note

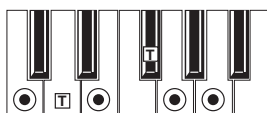

2-note

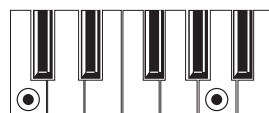

Major 7th

4-note

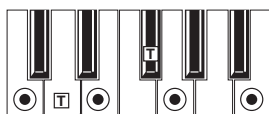

3-note



2-note



Sus 4

3-note

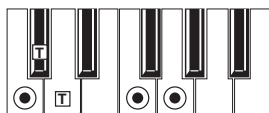

2-note

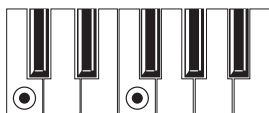

Sus 2

3-note



Dominant 7th

4-note

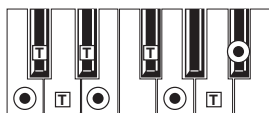

3-note



2-note



Dominant 7th Sus 4

4-note

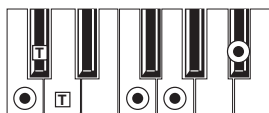

3-note

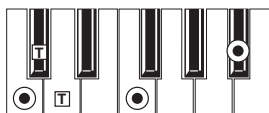

Flat 5th

3-note

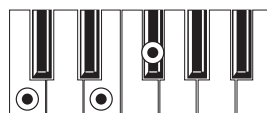

Dominant 7th b5

4-note

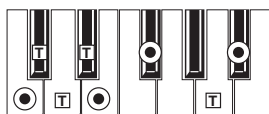

Major 7th b5

4-note

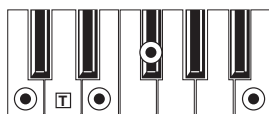

Major 7th Sus 4

4-note

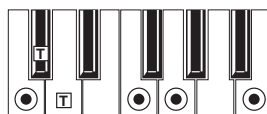

● = constituent notes of the chord

▣ = can be used as tension

Minor

3-note

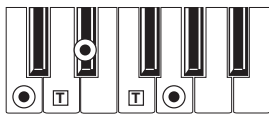

2-note



Minor 6th

4-note

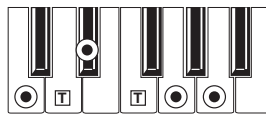

Minor 7th

4-note

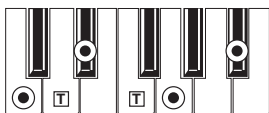

3-note



Minor-Major 7th

4-note

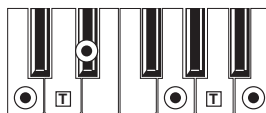

3-note



Diminished

3-note

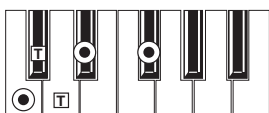

Diminished 7th

4-note

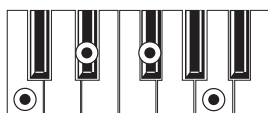

Diminished Major 7th

4-note

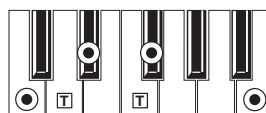

Minor 7th ^b5

4-note

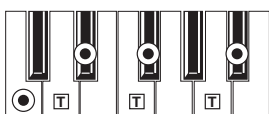

Augmented

3-note

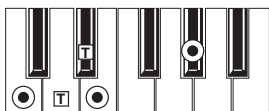

Augmented 7th

4-note

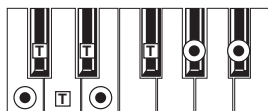

Augmented Major 7th

4-note

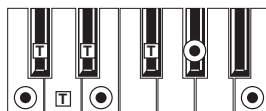

No 3rd

2-note



No 3rd, no 5th

1-note



● = constituent notes of the chord

⊠ = can be used as tension

Replacing the clock backup battery

You can replace the clock backup battery with a standard lithium battery (model CR2032). **Do not use replacements different than the one suggested by Korg, or you risk to damage the instrument!** The battery can be replaced by the user. **Korg is not responsible for any data loss, damage or injury caused by the incorrect installation of this part.**

Precautions

- Installation of the battery is done at the user's own risk. Korg will assume no responsibility for any damage or injury resulting from its improper installation or use.
- Be sure to disconnect the instrument from the AC plug, before opening it.
- To prevent your body's static electricity from damaging the board's components, touch an unpainted metallic component before proceeding with the installation.

Installation

For installation, you will need a cross-point and a flat-head screwdrivers (not supplied).

1. Disconnect the instrument from the AC power.
2. From the back of the instrument, use the cross-point screwdriver to remove the fixing screw (a).

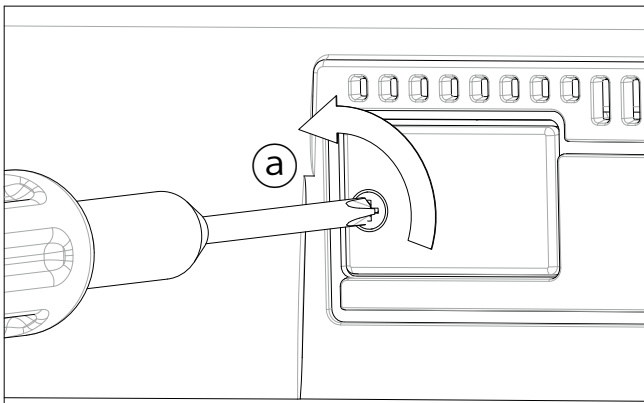

3. Use the flat-head screwdriver to open the cover (b) to gain access to the inside of the battery slot, and keep the cover apart.

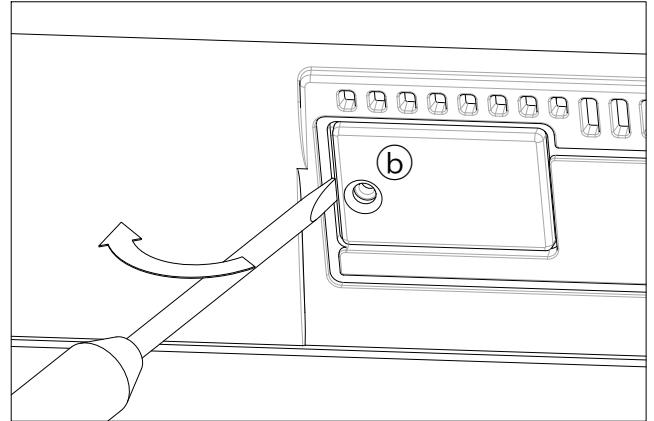

4. With the help of your fingernail, lift the exhausted battery (c) from its lower side, and remove it from the battery slot, being very careful not to let it fall inside the instrument.

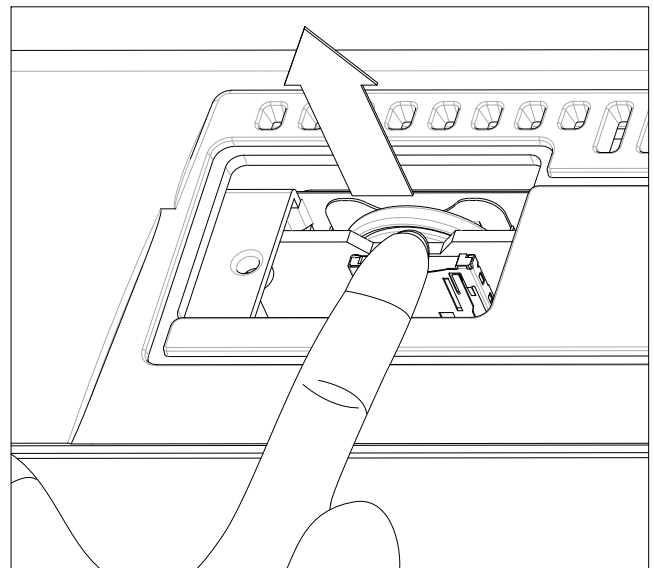

5. Insert the new battery (d) into the empty battery slot, being sure the positive (+) side is facing up. Be very careful not to let it fall inside the instrument.

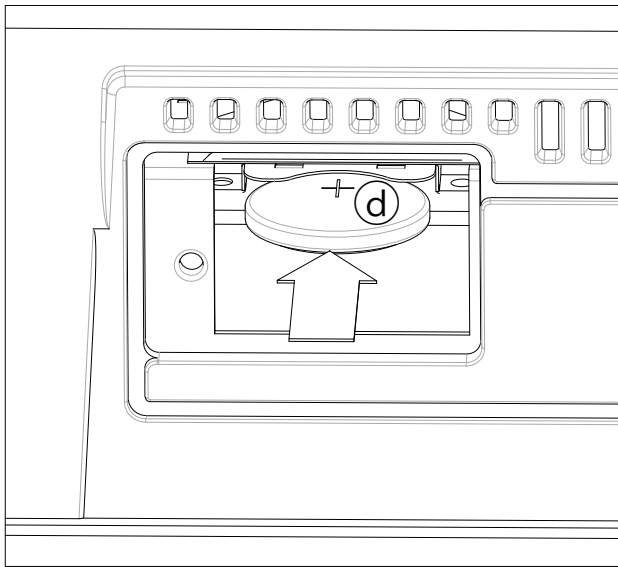

6. Replace the cover (b) to the original position. Attach the cover to the back of the instrument by using the fixing screw (a).

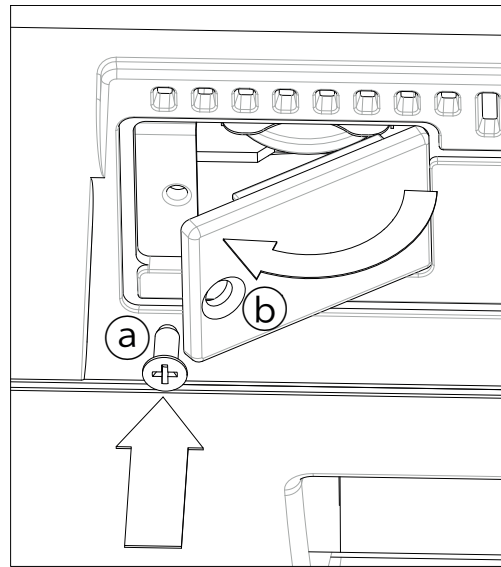

Installing a microSD card

To expand the available onboard memory, you can install an (optional) microSD card inside Pa900. The card can be installed by the user. **Korg is not responsible for any data loss, damage or injury caused by the incorrect installation of this part.**

Precautions

- Be sure to disconnect the instrument from the AC plug, before opening it. **Warning:** Removing or inserting the microSD card while the instrument is connected to the AC plug may damage the instrument!
- To prevent your body's static electricity from damaging the board's components, touch an unpainted metallic component before proceeding with the installation.

Installation

For installation, you will need a cross-point and a flat-head screwdrivers (not supplied).

1. Disconnect the instrument from the AC plug.
2. From the back of the instrument, use the cross-point screwdriver to remove the fixing screw (a).

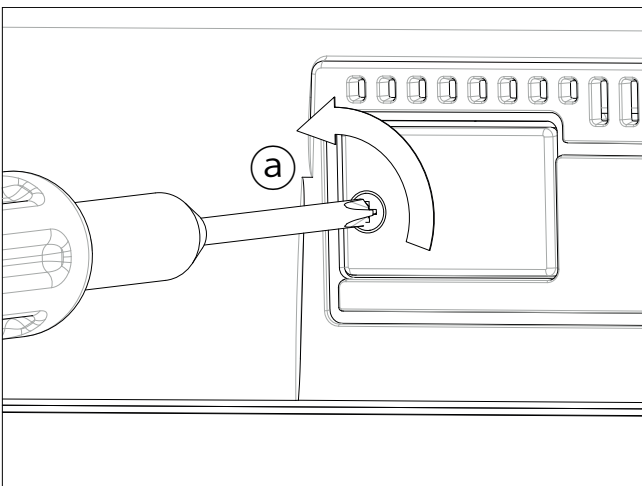

3. Use the flat-head screwdriver to open the cover (b) to gain access to the inside of the microSD slot, and keep the cover apart.

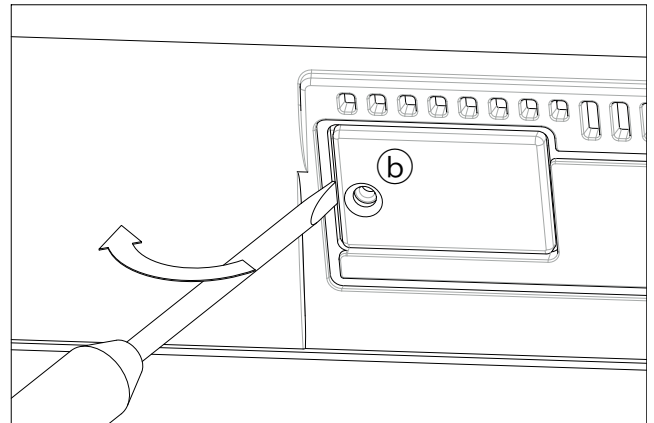

4. Insert the microSD card (c) into the empty card slot, being sure the connector side is facing down and toward the instrument. Gently push the card, until you hear a click sound meaning it is properly inserted. **Warning:** Be sure to insert the card correctly, or it may slip inside the instrument!

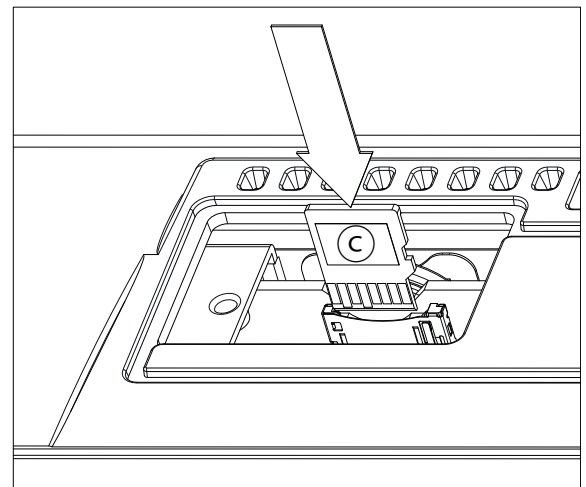

5. Replace the cover (b) to the original position. Attach the cover to the back of the instrument by using the fixing screw (a).

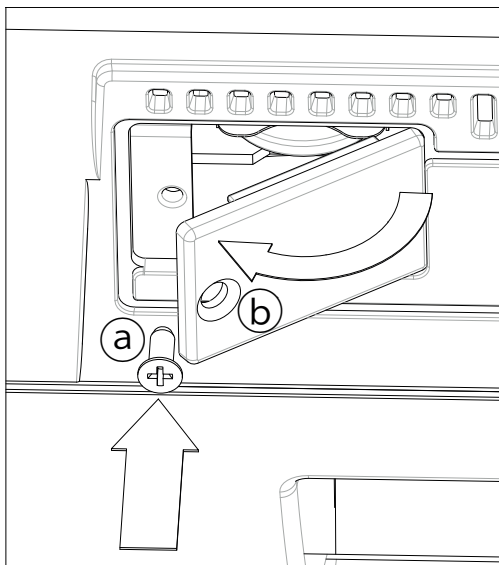

Accessing the microSD card

Once the microSD Key is installed, restart your Pa900. You can access the microSD card from any Media page, by using the Device selector and choosing the “SD [KORG SD]” storage device.

Removal

To extract the microSD card from its slot, just follow the installation instructions in reverse.

Shortcuts

Shift functions

You can keep the SHIFT button pressed, and press another button on the control panel to directly jump to an edit page or dialog box.

Shift +	Functions
Any modes	
Dial	Tempo Change
Scroll Arrows	<i>When a list is shown:</i> Goes to Next/Previous alphabetical section of the currently selected column
Sound	Sends the Sound assigned to the selected track to the Sound mode
Global	Selects the Global > MIDI > General Controls page. This is a quick way to jump to MIDI editing pages.
Media	Selects the Global > Mode Preferences > Media page
Start/Stop	Panic
Fade In/Out	Selects the Fade In/Out parameter in the Global > General Controls > Basic page
Synchro	Selects the Clock Source parameter in the Global > MIDI > General Controls page
Tempo Lock	Selects the Global > General Controls > Lock page
Metro	Selects the Metronome section of the Global > General Controls > Basic page
SongBook	Selects the SongBook > Custom List page
Transpose (either)	Selects the Global > Tuning > Transpose Controls page
Style Play mode	
Style Play	Selects the Global > Mode Preferences > Style page
Chord Scan (either)	
Memory	
Variation	Selects the corresponding Variation in the Style Play > Controls > Drum/Fill page
Ensemble	Selects the Ensemble Type parameter in the Style Play > Keyboard/Ensemble > Ensemble page
Pad (any)	Selects the Style Play > Pad/Assignable Switches > Pad page
Assignable Switch (any)	Selects the Style Play > Pad/Assignable Switches > Switch page
Upper Octave (either)	Selects the Style Play > Mixer/Tuning > Tuning page
Style Record mode	
Assignable Knob	<i>When the Sound/Expression page is shown:</i> Adjusts the Expression level
Tempo +/-	<i>When the Sound/Expression page is shown:</i> Adjusts the Expression level
Song Play mode	
Song Play	Selects the Global > Mode Preferences > Song & Seq page
Upper Octave (either)	Selects the Song Play > Mixer/Tuning > Tuning page
Pad (any)	Selects the Song Play > Pad/Assignable Switches > Pad page
Assignable Switch (any)	Selects the Song Play > Pad/Assignable Switches > Switch page
Play/Stop (either)	Start both Players at the same time

Shift +	Functions
Record	Open the MP3 Record dialog box
JukeBox	
>>	Play the next Song in the JukeBox list
<<	Play the previous Song in the JukeBox list
Lyrics	
Display	Load a TXT file
Sequencer mode	
Sequencer	Selects the Global > Mode Preferences > Song & Seq page
Upper Octave (either)	Selects the Global > Transpose Controls > Tuning page

Long keypress

You can keep a button pressed for about one second to directly jump to an edit page or dialog box.

Long keypress	Functions
Any operating modes	
Split	Opens the Split Point dialog box. Play a note to set the new Split Point.
Preset (Mic Setting)	Opens the "Write Voice Preset" window
Style Play mode	
Style	Opens the "Write Current Style Settings" window
Performance	Opens the "Write Performance" window
SongBook	Create a "New SongBook" Entry and open the "Write Song" window (only if pressed outside the SongBook)
STS	Opens the "Write STS" window
Song Play mode	
Performance	Opens the "Write Performance" window.
SongBook	Create a "New SongBook" Entry and open the "Write Song" window (only if pressed outside the SongBook)
Global mode	
Global	Touch Panel Calibration

Special functions

Other available shortcuts are the following ones.

Style Play mode	
Tempo +/- (together)	Original Tempo
Transpose #/b (together)	Set the Master Transpose to 0
Upper Octave +/- (together)	Set the Upper Octave to the original setting
Record	While recording MP3 Song, with MP3 Record Dialog Box closed, it stops the MP3 record and open the "Write Song Dialog)

Troubleshooting

Problem	Solution	Page
General problems		
Power does not turn on	Make sure that (1) the power cable is plugged into the outlet, (2) the cable is plugged into the connector on the back of the instrument, (3) and is not damaged, (4) there are no problems with the mains.	
	Is the STANDBY LED turned on?	
	If the power still does not turn on, contact your dealer or the nearest KORG Service Center.	
Power does not turn off	Press the POWER button again and keep it pressed for a few seconds. At the end, the button's LED will turn off, and the instrument will be set to standby.	
No sound	Is the MASTER VOLUME knob of the Pa900 set to a position other than "0"?	
	Is the Speakers parameter turned off? Turn it on.	262
	Check the connections to your amp or mixer.	
	Make sure that all the components of the amplifying system are turned on.	
	Is the Local parameter set to off? Turn it on.	259
	Is the Attack parameter value too high? Set it to a lower value, to let the sound start faster. Is the Volume parameter too low? Set it to a higher value.	114, 122
Lowest note are not played	When the SPLIT LED is turned on, the keyboard is divided into a Lower part (lower notes, below the split point) and an Upper part (higher notes, above the split point). Is the Lower track muted? Unmute it.	
Wrong sounds	Do the USER banks contain modified data? Load the appropriate data for the Song or the Style you wish to playback.	281
	Has one of the USER Drum Kits been modified? Load the appropriate Drum Kits.	281
	Have the Styles or Performances been modified? Load the appropriate data (Styles or Performances).	281
Sound does not stop	Make sure that the Damper pedal calibration is correctly set.	256
The selected Style or Song cannot start	Make sure that the Clock parameter is set to Internal. If you are using the MIDI Clock of another device, you must set the MIDI Clock parameter to MIDI or USB (depending on the port the Pa900 is hooked to the other device through) and make sure that the external device transmits MIDI Clock data.	259
Does not respond to MIDI messages	Make sure that all MIDI or USB cables are connected correctly.	308
	Make sure that the external device is transmitting through MIDI channels enabled to receive in the Pa900.	260
	Make sure that the MIDI IN Filters of the Pa900 do not prevent the reception of messages.	261
Percussive instruments are not played correctly	Make sure that the Drum track is set to Drum Mode and the external device has not transposition applied.	120, 192
Some "clicks" can be heard when playing a percussive instrument	This is part of the sound, and not a problem.	
A background noise can be heard after selecting a Performance, Style or STS	The selected Performance, Style or STS recalled the effect "17 St. Analog Record", simulating the noise of a old vinyl recording.	
Media related problems		
Cannot format a device	Is the USB cable correctly connected?	
	Is the USB device correctly powered?	
	Is the device inserted correctly?	
	Is the write protect tab of the disk or card in the protect position? Unprotect it.	
Cannot save data to a device	Is the device formatted?	290
	Is the device inserted correctly?	
	Is the write protect tab of the disk or card in the protect position? Unprotect it.	
Cannot load data from a device	Is the device inserted correctly?	
	Does the device contain data compatible with the Pa900?	278
The message "Over Current Condition Detected on USB port: please remove the USB media" appears in the display	The USB device is probably defective, due to a short circuit, and cannot be used. While this will not damage the Pa900, it is advisable to remove the device.	

Technical specifications

Features	Pa900
Keyboard	61 keys semi-weighted with velocity and aftertouch
System	Upgradable Operating System, RX (Real eXperience), DNC (Defined Nuance Control), Multitasking, Load while play feature
Display	Color TouchView™, 7" TFT display
Tone Generator	KORG EDS (Enhanced Definition Synthesis) sound generator, 128 Voices, 128 Oscillators, Filters with Resonance, Three band EQ for each track
Effects	Up to 4 Stereo Digital Multi-Effects block system, 125 Master Effects types + 2 Global Effects
Voice	Voice Processor Technology by TC Helicon. Three-part Harmonizer, Reverb, Delay, plus Compressor and EQ
Sounds / Drumkits	More than 1100, including Stereo Piano and GM/GS compatibility; more than 70 Drum Kits. User area: 512 Sounds, 128 Drum Kits. Defined Nuance Control (DNC) Technology improved sounds.
Digital Drawbars	9 Footages
Sampling	Load/Import of Korg, Wav, AIFF and Soundfont; Export of Wav and AIFF; Edit, Time Slice PCM User Memory: 192 MB
Styles	More than 400 preloaded Styles, freely reconfigurable, 1200 available Style locations including Favorite and User banks. Eight Style tracks, 4 Single Touch Settings, 4 Pads and one Style Setting per Style, Guitar Track 2 mode, Parallel and Fixed NTT, Style Record with Step Record, Track and Event Edit functions. Style controls: 3 Intros, 4 Variations, 4 Fills, Break, 3 Endings, Synchro Start/Stop, Tap Tempo/Reset, Bass Inversion, Auto Fill, Manual Bass, Memory, Accompaniment Mute, Drum Mapping, Snare & Kick Designation, STS Mode
Chord Sequencer	Realtime Style Chord Sequencer Recorder
Performance	320 Realtime Performance locations, "My Setting" function
STS	Memorize Realtime tracks settings, up to 4 x Style, up to 4 x SongBook entries
Song Play	Patented XDS Crossfade Dual Sequencer Player (supported formats: MID, KAR, MP3 + Lyrics, MP3+G). 2 Players with separate Select, Start/Stop, Home, Rewind and Fast Forward controls, X-Fader Balance control Lyrics, Score, and Chord data can be displayed on screen, or on external video monitor. Markers, Jukebox function.
MP3 Player / Recorder	Double MP3 Player and MP3 Recorder, Real Time Transpose (+6/-5 semitones), Tempo change (±30%), Vocal Remover. Record MP3 files including Styles, SMF, Real Time Tracks, Pads, Microphone and Effects.
Sequencer	Quick Record (Backing Sequence), Multitrack and Step Record functions. Full-featured Sequencer, 16 tracks; up to 200,000 events, SMF native format
SongBook	Fully programmable music database, based on Styles, SMF, Karaoke, MP3 with automatic selection of Style Play and Song Play modes. User-definable custom lists, Filtering and Ordering options.
Compatibility	i-Series: Styles; Pa-Series: Style, Performance, Program/Sound, Song, SongBook, Pad
Multi Pad	4 Assignable Pads + Stop Button. Pad Record function
General Controls	Master Volume; Fade In/Out; Keyboard-Acc/Song Balance Volume; Ensemble; Octave Transpose; Master Transpose; Style Change; Quarter Tone and Arabic Scale memorized inside Performance/STS; Realtime controllers: Joystick (pitch + modulation), Mic Volume, FX Level; Mic On/Off; Mic Preset; Harmony On/Off; 3 Assignable Switches; Tempo +/-; Tempo Lock; Dial; Search Function; Shift; Chord Scan; Split; Metronome On/Off; Sound Select
Control Inputs	Damper (supports half-pedaling with the optional DS-1H pedal), Assignable Pedal/Footswitch
Clock	Internal System Clock
Mass Storage/Disk	SSD standard; microSD (optional, back panel slot)
MIDI	In, Out; Standard MIDI connectors; USB to MIDI using the USB Device port. 8 user-definable MIDI Setups
Video Out	RCA connector
USB	1 USB Host (front) and 1 USB Device (rear), 2.0 Hi Speed connections
Mic/Line Audio Inputs	2 Unbalanced Jacks; Left/Mono-Mic, with gain control and Right/Mono
Audio Outputs	2 Unbalanced Jacks; Left/Mono, Right/Mono Headphones (in the front panel)
Amplification	2 x 20 Watt; 2 x 100 mm Woofer in Bass Reflex Box and 2 x Tweeter
Consumption	20 Watt, 100-240 V, 50/60 Hz
Dimensions (W x D x H)	1030 x 378.3 x 138.8 mm / 40.55 x 14.89 x 5.46 inches (without music stand)
Weight	10.76 kg / 23.72 lbs
Accessories	Printed Manual, AC Power Cable, Music Stand, DVD-ROM
Options	EXP-2 - Expression/Volume Pedal, XVP-10 - Professional Expression/Volume Pedal, DS-1H - Damper Pedal, PS-1/PS-3 Switch Pedal

Specifications and appearance are subject to change without notice for improvement.

MIDI Implementation Chart

KORG Pa900
OS Version 1.0 - March 01, 2013

Function	Transmitted	Recognized	Remarks
Basic Channel	Default	1-16	Memorized
	Changed	1-16	
Mode	Default	3	
	Messages	X	
	Altered	*****	
Note Number:		0-127	
	True Voice	*****	
Velocity	Note On	O 9n, V=1-127	
	Note Off	O 8n, V=0-127	
Aftertouch	Poly (Key)	O	Player data only *1
	Mono (Channel)	O	*1
Pitch Bend	O	O	
Control Change	0, 32	O	Bank Select (MSB, LSB) *1
	1, 2	O	Modulations *1
	6	O	Data Entry MSB *1
	38	O	Data Entry LSB *1
	7, 11, 16	O	Volume, Expression, Ribbon *1
	10, 91, 93	O	Panpot, A/B Master FX Send *1
	64, 66, 67	O	Damper, Sostenuto, Soft *1
	65, 5	O	Portamento On/Off, Portamento Time *1
	71, 72, 73	O	Harmonic Content, EG time (Release, Attack) *1
	74, 75	O	Brightness, Decay Time *1
	76, 77, 78	O	Vibrato Rate, Depth, Delay *1
	80, 81	O	Sound Controller (1, 2) *1
	98, 99	O	NRPN (LSB, MSB) *1, 2
	100, 101	O	RPN (LSB, MSB) *1, 3
120, 121	X	O	All sounds off, Reset all controllers *1
Program Change		O 0-127	
	True #	*****	
System Exclusive	O	O	*4
System Common	Song Position	X	X
	Song Select	X	X
	Tune	X	X
System Real Time	Clock	O	O *5
	Commands	O	O *5
Aux Messages	Local On/Off	X	X
	All Notes Off	X	O (123-124)
	Active Sense	O	O
	Reset	X	X
Notes	*1: Sent and received when MIDI Filters In and Out are set to Off in Global mode. *2: Drawbar settings, Sound parameters, Selection of SongBook entries, Drum Kit Family settings. *3: LSB, MSB = 00,00: Pitch Bend range, =01,00: Fine Tune, =02,00: Coarse Tune. *4: Includes Inquiry and Master Volume messages, FX settings, Quarter Tone settings. GM Mode On. *5: Transmitted only when the Clock Send parameter (Global mode) is set to on.		

Mode 1:OMNI ON, POLY
Mode 3:OMNI OFF, POLY

Mode 2:OMNI ON, MONO
Mode 4:OMNI OFF, MONO

O: Yes
X: No

Index

A

AIFF file format 242
 Amp EG 224
 AMS(Alternate Modulation Source)
 Amp EG 224
 Filter Cutoff 219
 Filter EG 219
 Filter LFO 219
 Pan 222
 Pitch 214
 Pitch EG 216
 Resonance 217
 Arabic Scale 112, 117
 Attack Level
 Amp EG 224
 Attack Time
 Filter EG 221
 Audio Inputs 17, 264
 Audio Outputs 22
 Auto Style/Perf/Sound Select 248

B

Backup 7
 Balance (Keyboard/Style or Ply) 9, 21
 Balance (Player) 21
 Bank Select 311
 Bass & Lower Backing 253
 BPM
 MIDI/Tempo Sync., LFO 226

C

Chord Scanning 15
 Lock 250
 Contrast 14
 Cutoff Frequency 217

D

Damper 22, 124
 Decay Time
 Filter EG 221
 Delay
 LFO 225
 Digital Drawbars 203
 Display contrast 14
 Double Player 12
 Drum tracks 120, 121, 126

E

Effects
 Copy 127, 176, 199, 227
 Sequencer mode 190, 191
 Song Play mode 172, 173
 Style Play mode 115, 119, 191

Ending 13
 Ensemble 123

F

Fade (Sound parameter)
 LFO 225
 Fade In/Out 247
 Favorite Styles 129
 Filter
 Cutoff Frequency 217
 Filter Type 217
 Filter Cutoff 219
 Filter EG 219
 Filter LFO 219
 Footswitch 255
 Format 290

G

General MIDI 309
 Global 246–276
 Global channel 309

H

Harmony track (Voice Processor)
 MIDI channel 260
 Note Input Source 266

I

Inputs 17, 264
 Intro 13

J

Jukebox 170, 175

K

Keyboard Mode (Split) 16
 Lock 250
 KMP file format 242
 KSF file format 242

L

Level (Sound parameter)
 Trim 217
 LFO
 Waveform, LFO waveform 225

Local Off 259, 311
Lower Lock 250

M

Markers 307
Master Transpose 16, 256
Master Tune 256
Master Volume 21
Media 277–294
 Format 290
Menu 15
MIDI
 Clock 165, 259
 General MIDI 309
 Global channel 309
 IN channels 260
 Interface 311
 OUT channels 261
 Preset 258, 309
 Standard MIDI File 166, 177
MIDI interface 311
MIDI Preset 258, 309
 Write 275
Midifile 166, 177, 309
Mode
 Sampling 231–245
 Sequencer 177–200
 Song Play 165–168
 SongBook 295–303
 Sound 201–230
 Style Play 106–129
 Style Record 130–164
MP3 167, 175, 295, 304

O

Octave Transpose 16, 116
 Auto Octave 249
 Midi In 259
Offset
 Offset, LFO 225
Operating Modes 10
OS (Operating System)
 Backup 7
 Update 7
Outputs 22

P

Pads 12, 125
Pan
 Pads 125
 Sound 213, 222
 Style tracks 114
PANIC (SHIFT+START/STOP) 14
PCG file format 242
Pedals 255
Performance 106
 Selecting 102
 Writing 128

Pitch 214
Pitch Bend 117, 191
Pitch EG 216
Player
 Transport controls 12, 13
Portamento
 AMS 229
Program Change 311

Q

Quarter Tone 112, 117

R

Resonance 217
RX 197

S

Sampling 231–245
Sampling mode 231–245
Scale
 Main scale 257
Sequencer mode 177–200
Shift 12
Single Touch 11, 12
Single Touch Setting (STS) 12
 Selecting 12, 103
 Writing 128
Song
 Markers 307
 Play from disk 103, 199
 Recording 179–189
 Selecting 103, 199
 Standard MIDI File 309
Song Play mode 165–168
SongBook 295–303
Sound
 Editing 122, 174, 192
 Selecting 101
 Writing 228
Sound mode 201–230
Split (Keyboard Mode) 16
 Lock 250
Split Point 112, 309
Standard MIDI File 166, 177, 309
STS, *See* Single Touch Setting
Style
 Ending 13
 Intro 13
 Recording 130–164
 Selecting 10, 100
 Style Settings 106
 Variation 13
Style Play mode 106–129
Style Record mode 130–164
Style Settings
 Selecting, *see* Style
 Writing 129
Sync.
 Key Sync., LFO 225
 MIDI/Tempo, LFO 226

Synchro Start/Stop 14

T

Talk

- Auto On/Off 269
- On/Off 113
- Settings 269

Tap Tempo 13

Tempo/Value section 15

Touch Panel

- Calibration 274

Track Select 11

Tracks

- Drum/Percussion 120, 121, 126
- Keyboard tracks 106, 166
- Octave Transpose 16
- Volume 114, 172, 190

Transpose 16, 116

- Auto Octave 249
- Midi In 259

Trinity 231, 242

Triton 231, 242

Tune

- Tune (Sound parameter) 206

U

Upper Volume Link 114

USB 292

V

Variation 13

Velocity

- AMS 229
- Velocity Intensity, Amp Mod. 223
- Velocity, Filter EG 218

Velocity Curve 255

Video Interface 19, 264

Voice Processor

- Harmony Track
 - MIDI channel 260
 - Note Input Source 266

Voice Processor Preset

- Editing 265

Voice Processor Setup

- Editing 269

Volume

- Balance 106, 165
- Balance (Keyboard/Style or Ply) 9, 21
- Balance (Player) 21
- Individual tracks
 - Sequencer 190
 - Song Play 172
 - Style Play 114
- Master 21, 106, 165

W

WAVE file format 242

KORG

Address

KORG ITALY SpA
Via Cagiata, 85
I-60027 Osimo (An)
Italy

Web

www.korg.com

