

# PMQ Series

## User manual

PMQ240 / PMQ480 / PMQ600



# Index

<b>Introduction</b>	<b>4</b>
<b>Precautions</b>	<b>7</b>
Safety requirements	7
Caution servicing	7
EC Declaration of Conformity	7
Waste of Electrical and Electronic Equipment (WEEE)	8
Caution	8
<b>Chapter 1: Pin connections and connectors</b>	<b>9</b>
Connection standards	9
<b>Chapter 2: Front &amp; rear panel</b>	<b>11</b>
Front panel overview	11
Front panel description	11
Rear panel overview	13
Rear panel description	13
<b>Chapter 3: Quick start guide</b>	<b>14</b>
Connecting the amplifier	14
Configuring the amplifier	14
Ready	15
<b>Chapter 4: Connecting the amplifier</b>	<b>16</b>
Input connections	16
Output connections	17
Connection examples	18

<b>Chapter 5: Configuring the amplifier</b>	<b>19</b>
Menu structure overview	19
Main screen	20
Settings menu	20
Level	20
Input	21
Mute	21
Output setup	21
Filters	21
Equalizing	22
Delay	23
Max level	23
Standby	23
Limiter	23
Phase reverse	24
Roll off	24
Output type	24
Clear presets	24
General setup	24
Input gain	25
Password	25
LCD	25
USB	26
Info	27
Temperature	24
Factory reset	27
Save	27
Lock	27
<b>Chapter 6: Additional information</b>	<b>28</b>
Technical specifications	28
Notes	30

# Introduction

## WaveDynamics™ Quad channel 100V power amplifiers



The PMQ series are quad channel Class-D 100V power amplifiers featuring WaveDynamics™ audio processing technology. They come in different output powers of 240 Watt, 480 Watt and 600 Watt. Their great flexibility and different configurations make it the solution for nearly every system, no matter if it's a fixed installation or a mobile application.

### WaveDynamics™

A complete library of AUDAC loudspeaker and set solution presets is available for your projects, making it easy as picking the right file, loading it & play! Besides the optimal acoustic configurations, this library also includes the loudspeaker performance parameters providing a bulletproof protection for them.



Speaker Presets

The 7-band fully parametric equalizer with adjustable frequency and Q factor and Butterworth, Bessel and Linkwitz-Riley filters with selectable roll-off allow you to create custom configurations, tweak your setup to the finest detail and adapt to your rooms acoustics. A delay function allows time alignment of different speakers in your installation.



7-Band EQ

Each output is individually software configurable between 100V or 8 Ohm, offering optimal flexibility for installations with 100V and low impedance loudspeakers combined. Typical applications are venues with 100V high frequency widely spread and low impedance bass cabinets added.



Digital Audio Filters

### Controllability

The operation and configuration of the device can be done in multiple ways. The most obvious way is by using the front panel controls, featuring a rotary selection dial and channel selection buttons with a clear and intuitive user interface on the 2.5" graphical LCD Display.



Time Alignment

Total system configurations for pre-defined set solutions can be loaded into the amplifier using the USB port.



Dynamic Bass

Integration of the audio system into home and industrial automation systems is made easy through the RS-232 connection & control port whereby functions such as input switching, volume adjustment, ... can be controlled.

## Flexibility



Input Matrix

Every system comes with different requirements and every customer has his own preferences. Because of this, the structure is made as flexible as possible.

This is achieved by an input selection matrix. Each of the input connections can be patched to any amplifier channel and contains software controllable gain. The different implementations of input connections allow the easiest way for connecting in every application, while allowing signal link through to other amplifiers.

## Protection



Speaker Protection

Optimal protection is not only required for the listeners satisfaction, but can also be important for complying to the imposed regulations and guaranteeing the lifetime of the equipment. Because of this, protection precautions are implemented in different ways.

Firstly, user access is made possible on different levels. The device can be blocked or accessed in user or administrator level. Different levels allow different configuration and control functions, giving limited (Eg: only volume) control access to standard users and full configuration control to administrators. User restriction can be enabled & disabled and is given through password and / or USB-key.



Lockable

Secondly, equipment protection is implemented by an output limiter which monitors the output power of every channel and will intervene when the output exceeds the maximum level. When the output limiter is configured at the maximum power of the loudspeaker, you can rest assured that the speakers won't be blown during your absence.



Limiter

Lastly, the maximum volume for every channel can be set independently. This prevents users (having volume access) going over the limit. This can help you to keep the system compliant with imposed regulations and maintain the good relationship with the neighbors.

## Efficiency



Energy Efficiency

The switching mode power supply and Class D Amplifier technology in combination with the auto-standby mode for each separate amplifier channel brings an end to the era of the power-hungry amplifiers. In addition, these features also result in a lightweight amplifier which benefits the customer when used in mobile applications.

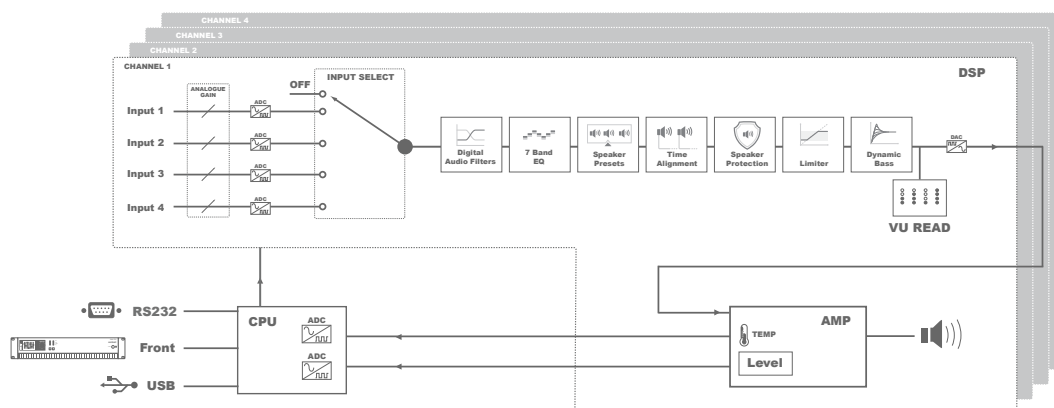



# Precautions

## **READ FOLLOWING INSTRUCTIONS FOR YOUR OWN SAFETY**

ALWAYS KEEP THESE INSTRUCTIONS. NEVER THROW THEM AWAY

ALWAYS HANDLE THIS UNIT WITH CARE

HEED ALL WARNINGS

FOLLOW ALL INSTRUCTIONS

NEVER EXPOSE THIS APPARATUS TO RAIN, MOISTURE, ANY DRIPPING OR SPLASHING LIQUID. NEVER PLACE AN OBJECT FILLED WITH LIQUIDS, SUCH AS VASES, ON TOP OF THIS APPARATUS

NO NAKED FLAME SOURCES, SUCH AS LIGHTED CANDLES, SHOULD BE PLACED ON THE APPARATUS

DO NOT PLACE THIS UNIT IN AN ENCLOSED ENVIRONMENT SUCH AS A BOOKSHELF OR CLOSET. ENSURE THERE IS ADEQUATE VENTILATION TO COOL THE UNIT.

DO NOT COVER THE VENTILATION OPENINGS WITH ITEMS SUCH AS NEWSPAPERS, TABLE CLOTHS, CURTAINS, ETC. DO NOT STICK ANY OBJECTS THROUGH THE VENTILATION OPENINGS.

ALWAYS KEEP A FREE DISTANCE OF 10 CM ON FRONT AND REAR OF THE APPARATUS FOR SUFFICIENT AIR CIRCULATION.

DO NOT INSTALL THIS UNIT NEAR ANY HEAT SOURCES SUCH AS RADIATORS OR OTHER APPARATUS THAT PRODUCE HEAT

DO NOT PLACE THIS UNIT IN ENVIRONMENTS WHICH CONTAIN HIGH LEVELS OF DUST, HEAT, MOISTURE OR VIBRATION

THIS UNIT IS DEVELOPED FOR INDOOR USE ONLY. DO NOT USE IT OUTDOORS

PLACE THE UNIT ON A STABLE BASE OR MOUNT IT IN A STABLE RACK

ONLY USE ATTACHMENTS & ACCESSORIES SPECIFIED BY THE MANUFACTURER

UNPLUG THIS APPARATUS DURING LIGHTNING STORMS OR WHEN UNUSED FOR LONG PERIODS OF TIME

ONLY CONNECT THIS UNIT TO A MAINS SOCKET OUTLET WITH PROTECTIVE EARTHING CONNECTION

THE MAINS PLUG OR APPLIANCE COUPLER IS USED AS THE DISCONNECT DEVICE, SO THE DISCONNECT DEVICE SHALL BE READILY OPERABLE

USE THE APPARATUS ONLY IN MODERATE CLIMATES



### CAUTION – SERVICING

This product contains no user serviceable parts. Refer all servicing to qualified service personnel. Do not perform any servicing (unless you are qualified to)



### EC DECLARATION OF CONFORMITY

This product conforms to all the essential requirements and further relevant specifications described in following directives: 2014/30/EU (EMC) and 2014/35/EU (LVD)



### WASTE ELECTRICAL AND ELECTRONIC EQUIPMENT (WEEE)

The WEEE marking indicates that this product should not be disposed with regular household waste at the end of its life cycle. This regulation is created to prevent any possible harm to the environment or human health.

This product is developed and manufactured with high quality materials and components which can be recycled and/or reused. Please dispose this product at your local collection point or recycling centre for electrical and electronic waste. This will make sure that it will be recycled on an environmentally friendly manner, and will help to protect the environment in which we all live.

### CAUTION

The symbols shown are internationally recognized symbols that warn about potential hazards of electrical products. The lightning flash with arrow point in an equilateral triangle means that the unit contains dangerous voltages. The exclamation point in an equilateral triangle indicates that it is necessary for the user to refer to the users manual.



These symbols warn that there are no user serviceable parts inside the unit. Do not open the unit. Do not attempt to service the unit yourself. Refer all servicing to qualified personnel. Opening the chassis for any reason will void the manufacturer's warranty. Do not get the unit wet. If liquid is spilled on the unit, shut it off immediately and take it to a dealer for service. Disconnect the unit during storms to prevent damage.



# Chapter 1

## Pin connections and connectors

### CONNECTION STANDARDS

The in- and output connections for AUDAC audio equipment are performed corresponding to international wiring standards for professional audio equipment.

#### XLR:

For balanced signal input connections



**Pin 1:** Ground  
**Pin 2:** Signal +  
**Pin 3:** Signal -

#### 3-Pin Terminal Block:

For balanced signal input & link output connections.

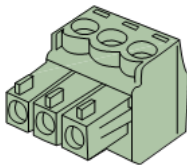

**Left:** Signal - (XLR Pin 3)  
**Center:** Signal + (XLR Pin 2)  
**Right:** Ground (XLR Pin 1)

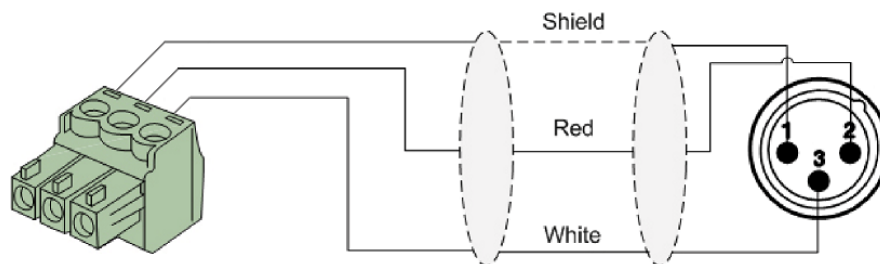

### RS232 (serial connection interface):

For connection with home automation systems, or other remote control equipment

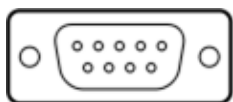

#### Connection

**PIN 2**

Standard RS232

PMQ TX

**PIN 3**

PMQ RX

**PIN 5**

GND

#### Settings

19200 Baud

8 Bit

1 Stop bit

No parity

No Handshaking

### RS232

The complete command set to control the PMQ amplifiers through RS–232 is available in the commands user manual which is freely downloadable on [www.audac.eu](http://www.audac.eu)

# Chapter 2

## Front & rear panel

### Front panel overview

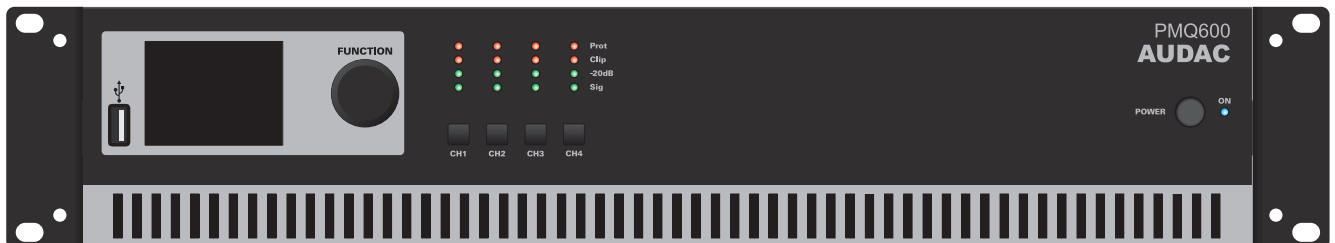

### Front panel description

The front panel of all PMQ amplifiers is identical among all the different models. All models are including an USB port, LCD display and rotary selection dial.

#### **USB port:**

A USB port is provided on the left side of the front panel. This is used for inserting flash drives with configuration files to load into the amplifier or duplicating system configuration files to the inserted medium. The inserted flash drive shall support FAT32 filesystem.

#### **Graphical LCD display:**

A clear system overview and intuitive user interface is provided on the 2.5" graphical LCD display. This true colour display provides a clear overview of the amplifiers operation mode guaranteeing an user friendly experience when browsing through the menu structure.

#### **Rotary selection dial:**

Browsing through the menu structure and adjusting parameters is made easy with the rotary selection dial. This multifunctional rotatable dial allows easy one-hand operation throughout the entire menu structure. Browsing can be done by turning it while actions will be taken when pressing it.

#### **Channel selection buttons with indicator LED's:**

Channel selection and monitoring is made easy through a selection button together with four indicator LED's for every channel. When pressing the button, the menu structure will call the settings of the corresponding channel, allowing adjustment of the parameters.

The LED's give a continuous indication of the operation of the corresponding channel. The green Signal LED illuminates whenever a signal is present, while the -20dB LED illuminates when the input signal exceeds the - 20 dBu level. The Clip LED illuminates when the corresponding channel is working at maximum level. To ensure the best signal-to-noise ratio, the Clip LED may only illuminate at peak levels.

When the Clip LED illuminates, the output limiter of the amplifier will intervene avoiding a distorted “Clipping” sound on the output. The Protection LED will illuminate when overheating occurs or any other fault is detected. When the protection LED is illuminated, no signal will be present on the outputs.

When the level for multiple outputs should be adjusted simultaneously, press and hold their channel selection buttons for about 3 seconds. The desired channels will be simultaneously selected and changes will apply to all selected channels.

**Power switch:**

A power switch allows to switch the amplifier on and off, while the blue indicator LED located next to the button illuminates when the power is switched on.

# Rear panel overview



## Rear panel description

The rear panel of all PMQ series amplifiers is identical among all models with various power ratings.

### AC Power inlet with fuse:

The mains power supply (230 V AC / 50 Hz) has to be applied to this AC power inlet. The connection is made by an IEC power connector and is fitted with a fuse. When replacing the fuse, make sure that the value of the replacement fuse matches the value of the original fuse. (PMQ240: T6.3AH/250V – PMQ480: T12AH/250V – PMQ600: T16AH/250V)

### Loudspeaker output connections:

The loudspeaker output connections are connected using 4–pin terminal block connectors. The 4–pin connections contain two (identical) terminals for both 100V and COM, allowing convenient connection for two loudspeaker lines. More information about loudspeaker output connections is described in a further chapter of this instruction manual ‘Connecting the amplifier’.

### Signal input connections:

Signal input connectors are implemented in two ways, using balanced XLR and 3–pin terminal block connectors. This way, connections coming from the signal source such as pre–amplifier, mixer or matrix system can always be made in the most easy and appropriate way while allowing signal linkthrough to other amplifiers.

### RS232 Connection:

The amplifier can be controlled through external hardware such as home & industrial automation systems by linking it to the RS–232 connection. The pinout and communication settings are described in an earlier chapter of this user manual. The complete RS–232 command instruction set and configuration information can be downloaded from the AUDAC website.

### Optional expansion port:

Installation of an optional Dante network interface (ANI44) is possible on the location of the expansion slot. In default configuration, this expansion slot is covered with a blind plate which needs to get removed before the optional interface is installed. More information about the exact installation procedure for the optional interface can be found with the supplied installation documentation or on the AUDAC website.

# Chapter 3

## Quick start guide

### Connecting the amplifier

#### ATTENTION

Make sure the power of the device is turned OFF before any connections or wiring adjustments are made. Disregarding this rule can lead to permanent damage of the equipment.

#### 1) Connecting the audio sources

Connect all the audio sources to the input connections on the rear side of the amplifier. Depending of the installation and the used sources (pre-amplifiers, mixers, matrix systems, ...) the appropriate selection of input connectors can be made between XLR and terminal block.

#### 2) Connecting the loudspeakers

Connect the loudspeaker lines to the 4-pin terminal block output connections on the rear panel of the amplifier. The loudspeaker lines shall be connected between the '100V' and 'COM' terminals for each output. All outputs contain two (identical) 100V and COM terminals, allowing convenient connection for two loudspeaker lines. More information about loudspeaker output connections is described in a further chapter of this instruction manual 'Connecting the amplifier'.

#### 3) Other connections

After the in- and output connections are made, other connections such as mains power (and RS-232 if required) can be made. After connecting them, the amplifier is ready to be powered-up and configured.

### Configuring the amplifier

#### 1) Configuration using presets:

In case your setup is a pre-defined set solution from AUDAC, a set solution configuration file will be available (\*.SOL) whereby all settings for the configuration can be made by uploading the corresponding file to the amplifier. In this case, the file should be stored on an USB storage device and inserted to the USB port on front of the amplifier. After inserted the USB storage device, browse to the 'Settings' > 'General setup' > 'USB' > 'Load', browse to the correct file and press the function dial. After selected, all settings for the set solution will be loaded in one action, the message "Settings loaded" will appear and all other configuration steps can be skipped. In case a custom configuration is required, proceed to the next step.

## 2) Configuring the outputs:

The first step when a custom configuration is required is configuring the output channels. In standard configuration, every output channel is configured as an 100 Volt output channel. When your installation requires a combination between 100 Volt and Low impedance (8  $\Omega$ ) speakers, this shall be configured by selecting the corresponding output and browse to the 'Settings' > 'Output setup' > 'Output type' menu.

**NOTE:** For further information about connecting the outputs in 100 Volt or 8 Ohm mode, see page 18 of this manual.

## 3) Configuring the inputs:

After the output configuration has been made, the next step is the input configuration. In standard configuration, every output channel is patched with the corresponding input channel (Input 1 to Output 1, ... ). In case this configuration is required for your setup, this step can be skipped. In cases where specific inputs should be assigned to the outputs, the input selection can be made in the settings menu under 'Settings' > 'Input'. Selection is possible between all applied inputs, including summed inputs (Converting stereo inputs to mono).

After the inputs are assigned to the outputs, the input gain for every used input should be set. The input gain can be adjusted under 'Settings' > 'General setup' > 'Input gain'. On the right side of this screen are colour indicators shown for every input, giving feedback of the currently set gain. A correct regulation of the input gain is achieved when the green indicator is frequently blinking, the orange indicator is only illuminated at the peaks (-6 dB) and the red indicator blinks rarely or not. When the red indicator blinks frequently, the input is overdriven and the gain needs to be reduced. When the green indicator blinks rarely or not, no input signal is detected and the gain needs to be increased.

## 3) Acoustics configuration:

After the in and output configurations have been made, the next step is making acoustic configurations and optimizations. When bass cabinets are used in the installation, it might be required to add low-pass filters to the bass cabinets channel, and high-pass filters to the mid/high loudspeakers channels. Filter configurations can be made in the 'Setup' > 'Output configuration' > 'Filters' menu. Sound quality can be optimized to specific acoustics using a 7-band equalizer which can be found in the same menu.

# Ready

After all above connections and configurations are made, the system is ready for rock & roll. More specific features such as password protection, standby mode, and many more can be configured. How this should be done can be found in further chapters of this instruction manual.

# Chapter 4

## Connecting the Amplifier

### NOTE

Make sure the power is switched OFF when changes are made to the connections of the amplifier.

## Input connections

The signal input connections are implemented through a balanced XLR and 3-pin terminal block (3.81 mm pitch) connector for each input. Both connectors are linked in parallel, allowing free selection to which connector the signal will be applied. If required, the second connector can be used for linkthrough of the applied signal to other amplifiers.

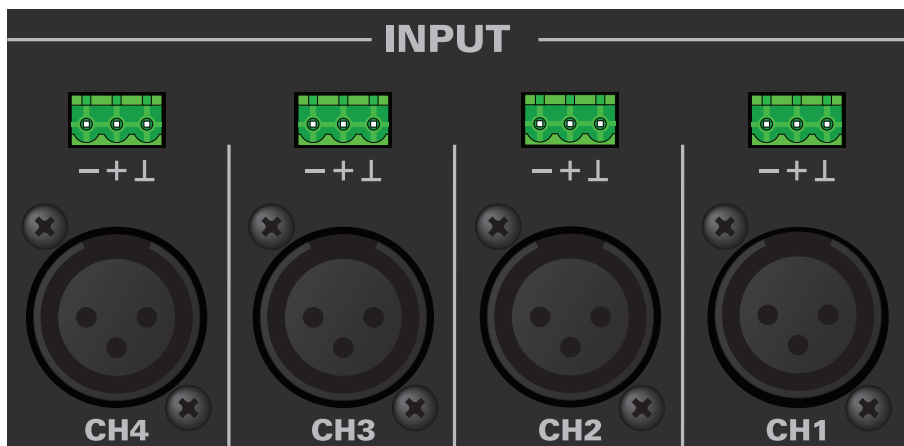

The input structure of the amplifier is made flexible due to the input selection matrix, meaning that any signal applied to the amplifier can be patched to any channel. When driving multiple channels by the same signal or summing stereo signals and converted into mono, external links are redundant due to the input matrix.

Selecting and assigning the input signals to the amplifier channels is made easy through software configurable user interface which is controllable using the front panel controls.



# Output connections

The loudspeaker output connections are implemented using 4-pin terminal block (5.08 mm pitch) connectors for each output.

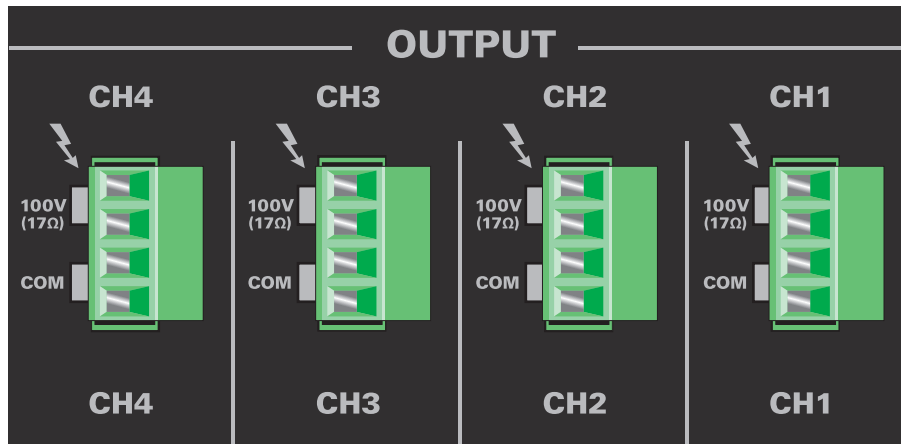

All outputs contain two (identical) 100V and COM terminals, allowing convenient connection for two loudspeaker lines.

The table below shows the output voltage, impedance and maximum power load for each amplifier type in 100 Volt or 8 Ohm output configuration:

	Output Voltage	Impedance	Power
PMQ240	100 Volt	41.7 Ohm	240 Watt
PMQ480	100 Volt	20.8 Ohm	480 Watt
PMQ600	100 Volt	16.7 Ohm	600 Watt

*PMQ series min load impedance in 100 Volt output mode*

	Output Voltage	Impedance	Power
PMQ240	43.2 Volt	8 Ohm	240 Watt
PMQ480	62.0 Volt	8 Ohm	480 Watt
PMQ600	69.3 Volt	8 Ohm	600 Watt

*PMQ series max output voltage in 8 Ohm output mode*

In 100 Volt output mode, numerous loudspeakers may be connected in parallel until the minimum load impedance for the entire loudspeaker line has been reached. The number of allowed loudspeakers is depending of the power / impedance of the connected speakers.

In 8 Ω mode, it is not allowed to connect a load impedance to the output of the amplifier which is below 8 Ω.

# 100 V Example connection diagram

Multiple loudspeakers can be connected in parallel, on both output connection terminals.

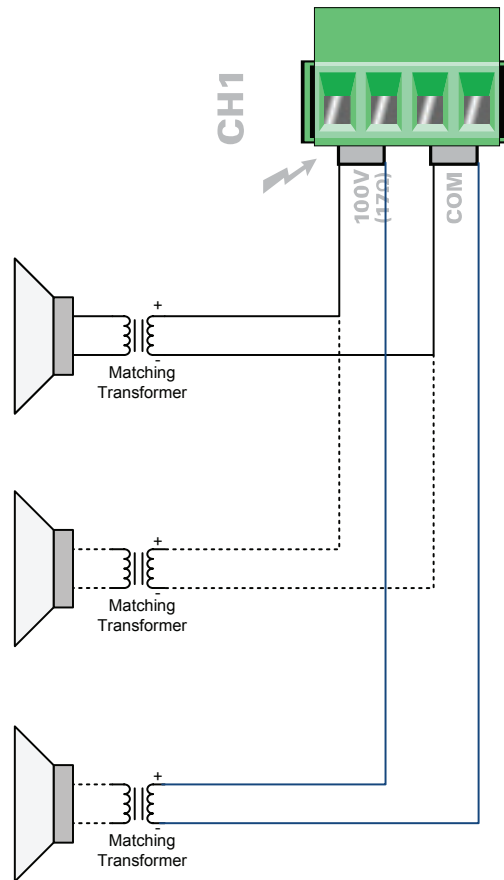

# 8 Ω Example connection diagram

Only one 8 Ω loudspeaker or two 16 Ω low impedance loudspeakers are allowed to be connected in parallel, when the amplifier is switched in 8 Ω mode.

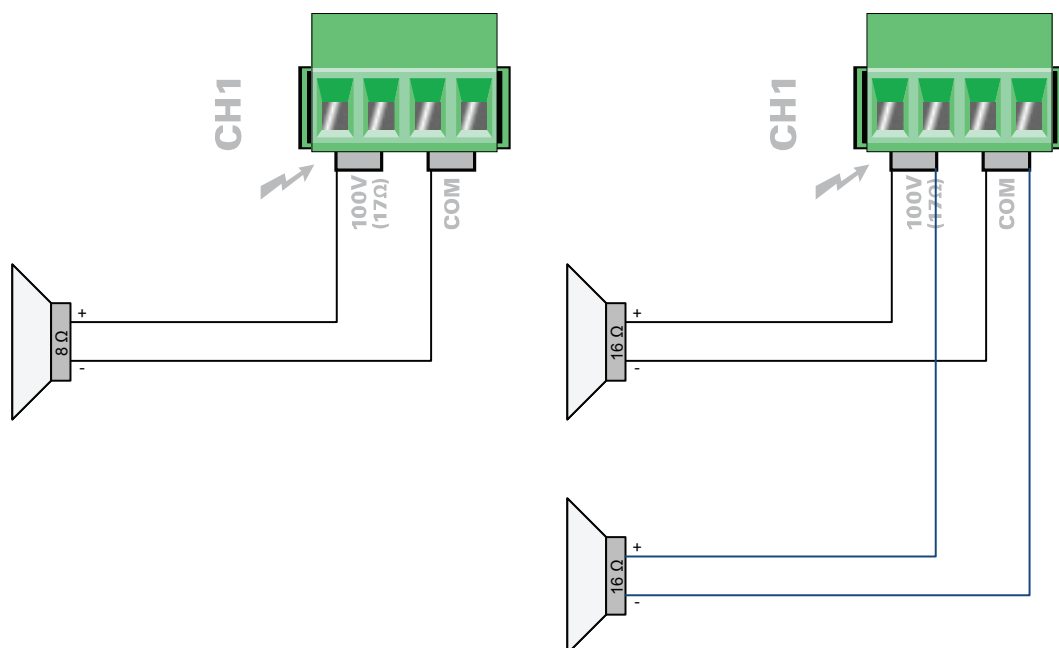

# Chapter 5

## Configuring the amplifier

The configuration of the amplifier can be done using the controls on the front panel of the amplifier. A graphical user interface is indicated on the front panel LCD display which guarantees an intuitive and user friendly experience. The menu structure is shown in below diagram, giving an overview of the configuration possibilities. The following pages give a detailed explanation for every configurable function.

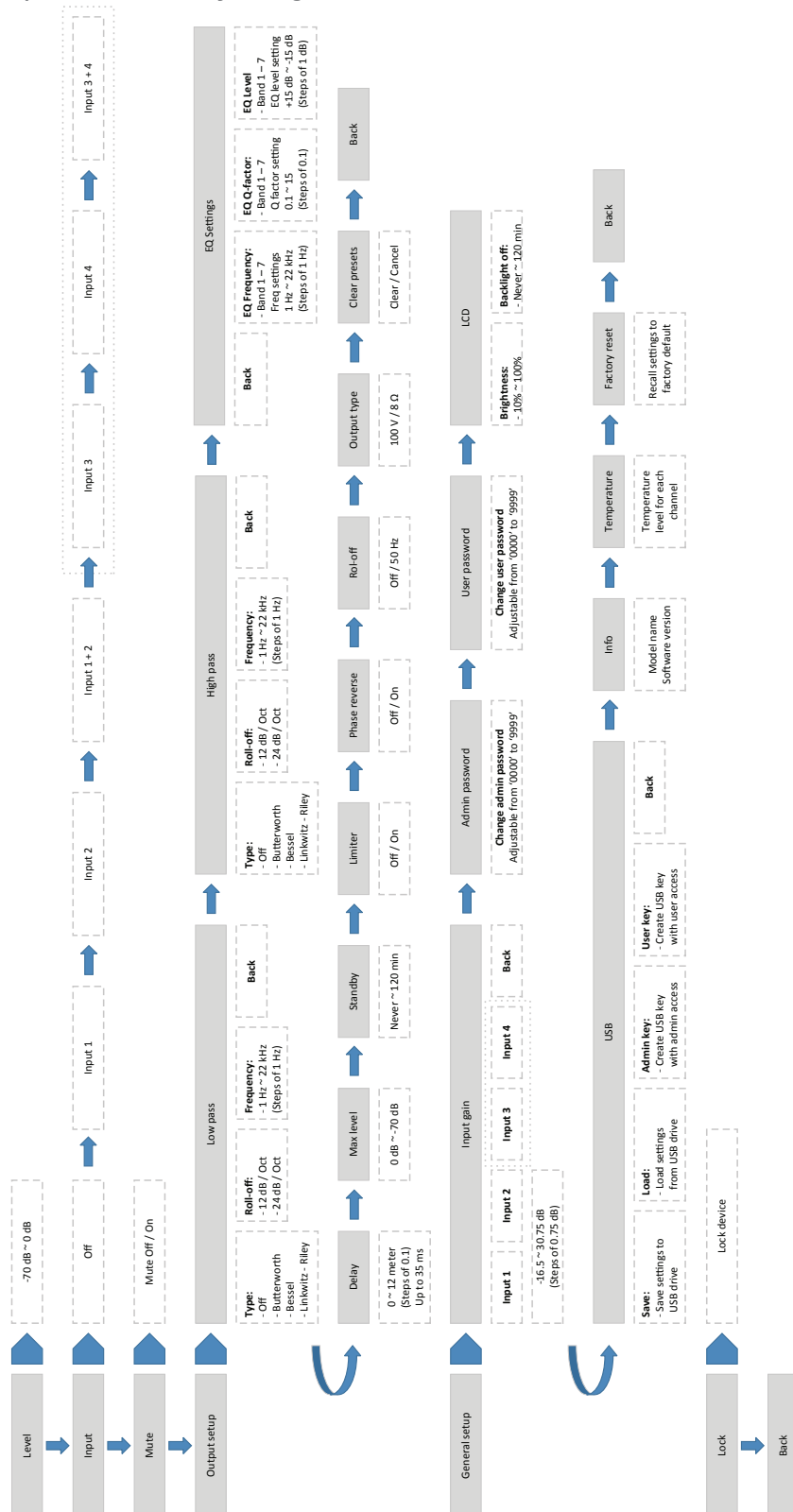

## Main screen

The main screen gives a fader overview of the amplifier outputs and allows to adjust the level for each of them.

On top of the screen, the names of the output channels are shown (OUT 1, OUT 2, ...). Right under, the name of the inputs (INPUT 1, INPUT 2, ...) linked with these outputs are indicated. And below the input, the level of the output channel is indicated.

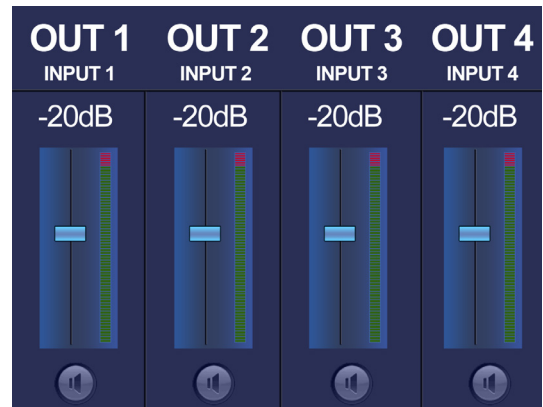

The selection of the corresponding channel can be made using the 'Channel selection buttons' which are located below the VU meters of every channel on the front panel of the amplifier. The output level for the currently operated channel is indicated in green and can be adjusted by turning the rotary function dial in clockwise (up) and counter-clockwise (down) direction. The fader will slide up or down when the output level is adjusted. The output level can be adjusted within range of 0 dB and -70 dB.

When the level for multiple outputs should be adjusted simultaneously, press and hold their channel selection buttons for about 3 seconds. The desired channels will be simultaneously selected and changes will apply to all selected channels.

On the bottom of the this screen, a mute indicator is shown for every channel. This button will be indicated in green when the channel is playing and turns red when muted.

## Settings menu

By pressing the rotary function dial once (when the main screen is displayed), the output settings menu will be shown. This menu is only accessible in administrator mode (will be described extensively in a later section of this user manual) and allows to make adjustments to the channel setup and general setup.

Scrolling through this menu is possible by turning the rotary function dial. The currently selected option will be highlighted and the possibilities will be shown on the right side of the screen. Settings can be called by pressing the rotary function dial. Depending of the selected setting, a selection menu will be indicated on the right side of the display, the selected setting will toggle between two possibilities or another selection screen will be indicated.

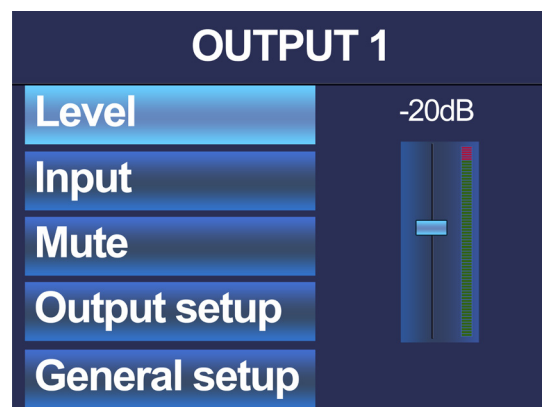

## Level

The first selection is the adjustment of the output level for the corresponding channel. The output level which can be selected here is identical to the output level which can be adjusted on the main screen of the amplifier as described above. It can be adjusted within a range of 0 dB and -70 dB. After the selection has been made, returning to the settings menu is possible by confirming the selection through pressing the rotary function dial.

# Input

The input linked to each channel can be selected in this screen. Every input signal can be linked to every output channel using the input selection matrix. Summed inputs for two sequent input channels can be selected too (E.g. Input 1+2). This can be useful when stereo input channels need to be patched to a mono output.

# Mute

Muting will completely suppress the output signal of the corresponding channel. The mute indicator will be shown in green when the channel is playing and turns red when muted. Toggling between both states can be done by pressing the rotary function dial once.

# Output setup

Output setup will lead you to a separate menu where the advanced configurations for the corresponding output can be made. The output setup menu is separately configurable for each of the outputs and includes configuration settings which generally will be made once for every setup / installation without having them adjusted frequently.

To return from the output setup menu back to the main menu, the 'back' option at the bottom needs to be pressed.

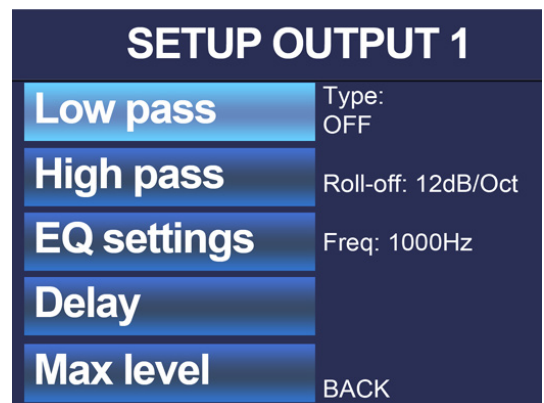

# Output setup >> Filters

Filters are frequently used in audio systems for different purposes. Some typical application examples are filtering noise or other unwanted signals from an audio signal and separating audio signals between different frequency ranges (crossover) when a 2-way (or more) system is used.

Because the characteristics of the required filter are strongly dependent of the application, the filter settings are made flexible and user configurable.

Filters are grouped in this menu under subdivisions 'low pass' and 'high pass', indicating which types of filters can be configured. When a 'Band pass' filter is desired, this can be achieved by a combination of a low and high pass filter.

Characteristics which can be configured for the filters are:

- Filter Type:** Selectable between Butterworth, Bessel, Linkwitz–Riley
- Roll-off:** Selectable between 12 dB/Oct and 24 dB/Oct
- Cutoff frequency:** Infinitely adjustable between 1 Hz and 22 kHz

The configuration of the desired filter can be made by selecting the required filter type in the column on the left side (Low pass or High pass). Subsequently the characteristics as described above can be adjusted on the right screen side. The currently selected parameter will be indicated in green and toggling between the different values is possible by pressing

the rotary function dial. If the parameter is set to the desired value, scrolling to the next field can be done by turning the function dial. When adjusting the frequency, a 5 digit number is shown and the adjusting digit can be selected (turns red) and confirmed by turning and pressing the rotary selection dial. Consecutive digits will increase when the maximum value has been reached. After the desired frequency has been selected it can be confirmed by pressing (turns orange) and turning the function dial clockwise to the entire right side where the 'OK' word will appear. After pressing again the frequency is confirmed and the next characteristic can be adjusted. If all characteristics are set to the required value, select the 'BACK' option and you will be returned to the output setup menu.

#### RECOMMENDATION

When separating frequency ranges in two or more way systems, a Linkwitz–Riley filter with 24 dB / Oct roll–off is recommended between different frequency ranges. A high–pass Butterworth filter with 24 dB / Oct roll–off is suggested for elimination of low frequencies outside the frequency range of the loudspeaker, avoiding subsonic overload.

## Output setup >> Equalizing

A parametric 7 bands equalizer will allow to cut or boost specific frequency ranges, helping to improve the sound and adapt it to acoustics of the location where its being used.

A standard configuration with center frequencies for 60 Hz, 150 Hz, 400 Hz, 1 kHz, 2.6 kHz, 6.8 kHz and 15 kHz with Q factor of 0.7 is pre–loaded. The center frequency of each band can be infinitely adjusted within a range of 1 Hz and 22 kHz, while the Q–factor can be adjusted within a range of 0.1 and 15 and the level of each band within a range of +15 dB and –15 dB.

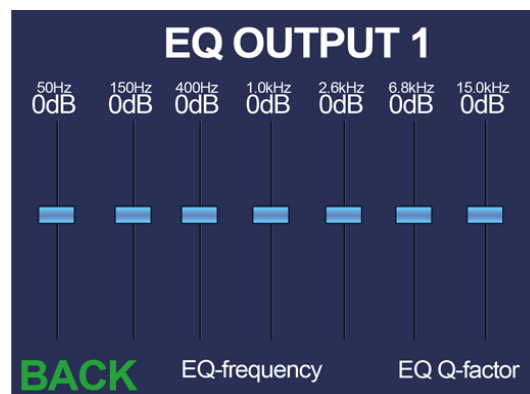

A fader overview for the 7 bands equalizer will be shown after selecting the 'EQ settings' menu item. On top of the screen, the center frequencies for each band are shown with right under the currently selected equalizing level.

The selection of the corresponding band can be made by turning the rotary selection dial until the corresponding band is indicated in green and pressing it. Level adjustment can be done by turning the selection dial and confirmed by pressing it again. After this confirmation, another band can be selected and adjusted in identical way.

Adjustment of the center frequencies and Q–factors can be done by selecting the corresponding 'EQ–frequency' and 'EQ Q–factor' buttons on the bottom of the screen. When selected, pop–up windows will appear where the corresponding adjustments for each band can be made. Adjustment of center frequencies can be made in similar way as described with filters above and Q–factors can be changed by selecting and turning clockwise (up) or counter–clockwise (down). This confirmation can be done by pressing again. After the required value for each band has been set, returning to the equalizer screen can be done by selecting the 'BACK' button.

The 'BACK' button in the left bottom corner of the equalizer screen can be selected and

pressed for returning back to the output setup menu.

## Output setup >> Delay

This function enables to create a specific delay between the input and the output signal. This delay can be used for time alignment between different loudspeakers in one configuration. It is configurable in meters within a range of 0 meter and 12 meter with a resolution of 0.1 meter / step. Adjustments can be done by selecting it and turning the rotary selection dial. After the required delay is selected, it can be confirmed by pressing the rotary function dial.

## Output setup >> Max level

This function will guarantee that the output level adjustable by the fader on the main screen (which is accessible through user level access) will never exceed a certain value as configured. This gives protection for non-authorized persons when increasing the volume. It can be adjusted within a range of 0 dB (no restrictions) and -70 dB.

The screen shows a fader with the configured maximum output level indicated above it. When selected, the fader including the currently configured maximum output level will turn green and the level is adjustable by turning the rotary function dial. The fader will slide up or down and after the desired value has been selected, it can be confirmed by pressing the rotary function dial.

## Output setup >> Standby

When no signal is detected for a corresponding channel, it will be switched automatically to standby mode. The delay time between the absence of a signal and switching to standby mode can be selected in this screen. It can be disabled (never) or adjusted within a range of 1 to 120 minutes. The power consumption will decrease when one or more channels are switched to standby.

## Output setup >> Limiter

The limiter avoids the output exceeding a maximum level. When configured in 100V mode, the limiter is standard disabled, allowing the output to slightly exceed the maximum voltage giving an optimal headroom to peaking audio signals. When enabling, the output level will be limited to the maximum level (100V).

When configured in 8 Ohm mode, the limiter is enabled and cannot be disabled. It will limit on the maximum allowed output voltage.

SETUP OUTPUT 1	
EQ settings	OFF
Delay	
Max Level	
Standby	
Limiter	

## Output setup >> Phase reverse

Phase reverse will shift the phase of the output over 180° with the input, for applications where a contrary phase is desirable.

## Output setup >> Roll off

Roll off allows to enable and disable a low-cut filter to the selected output. When the low-cut filter is enabled, frequencies below 50 Hz will be suppressed. This can be useful for eliminating low-frequency hum and noise caused by external equipment and protects speakers from damage caused by excessive low frequency transients.

## Output setup >> Output type

Output type allows to switch the channel between 100V and 8 Ohm (low impedance) operation mode. This setting is standard set to 100V mode and can be changed for each channel individually, offering optimal flexibility for installations with 100V and low impedance loudspeakers combined. Typical applications are venues with 100V high frequency widely spread and low impedance bass cabinets added.

## Output setup >> Clear presets

Loudspeaker and total system (set) configurations can be uploaded to the amplifier. Every preset is made and optimized for one specific loudspeaker or system. This window will indicate if any preset is currently loaded. Presets which are meant for others than the connected loudspeakers may affect the performance and sound quality in negative way, while not providing optimal protection.

Clearing of the currently loaded presets can be done by selecting this option and pressing clear. Please note that other configurations for the corresponding channel (Eg. filters, equalizing, ... ) which are separately made from the preset will remain unchanged. When a total system configuration (set solution \*.SOL) is currently loaded and cleared, other channel configurations which are part of this preset will be cleared too.

## General setup

The general setup will lead you to a separate menu where some global configuration settings for the amplifier can be made. Typical settings accommodated under general setup are password settings, ...

To return from the output setup menu back to the main menu, the 'back' option at the bottom needs to be pressed.



## General setup >> Input gain

The gain for each individual input can be set in this screen between a range of  $-16.5$  dB and  $+30.75$  dB. After scrolling and selecting the right input, gain can be adjusted through turning the rotary selection dial. Level indicators are shown on the right side of the display indicating the correct set gain level. Three color digits (green, orange and red) will illuminate at different levels and give feedback about the currently set gain. A correct regulation of the input gain is achieved when the green indicator is frequently blinking, the yellow indicator is only illuminated at the peaks ( $-6$  dB) and the red indicator blinks rarely or not. When the red indicator blinks frequently, the input is over driven and the gain needs to be reduced. When the green indicator blinks rarely or not, no input signal is detected and the gain needs to be increased.

GENERAL SETUP	
Input gain	Input 1: 18.75dB
Admin pass	Input 2: 25.50dB
User pass	Input 3: 5.25dB
LCD	Input4: 30.75dB
Usb	BACK

## General setup >> Password

Password protection is provided in two different levels, administrator and user level. Administrator level has full access to all available functions of the amplifier while user level only can access the volume of the amplifier. Both passwords consist of a 4 digit code which is intended to be different.

In standard configuration, both passwords are set to '0000'. In this case, full access is given without requiring any password. If either the configured user or administrator password is different from '0000', a password will be requested before access to the relevant functions is provided.

The configuration of the selected password can be made by selecting Admin pass or User pass in the column on the left side. The currently selected password will be shown and the adjusting digit can be selected (turns red) and confirmed by turning and pressing the rotary selection dial. Consecutive digits will increase when the maximum value has been reached. After the desired password has been selected it can be confirmed by pressing (turns red) and turning the function dial clockwise to the entire right side where the 'OK' word will appear. After pressing again the password is confirmed.

## General setup >> LCD

Adjustment for the LCD settings can be made in this screen. The brightness of the LCD can be adjusted within a range of 10% to 100% (standard is 80%). Adjusting of the LCD brightness can be convenient when the device is placed in an environment with very low or very high ambient light. Hereby the clarity of the LCD can be adjusted in such way being clearly but unobtrusive.

The backlight off time can be adjusted within a period of 5 up to 120 minutes in steps of 5 minutes or never (always on), making the backlight of the LCD automatically turn off after

the set time.

## General setup >> USB

USB will lead you to a separate sub–menu where all settings and options using USB functions can be found. An USB flash disk should be inserted to the USB slot on the front of the amplifier and shall be formatted using FAT32 filesystem.

## General setup >> USB >> Save

The complete configuration of the amplifier can be saved to a file by using the ‘save’ button. This way, a complete backup for system recovery can be made. This provides a great advantage for re–loading a previous configuration and duplicating the configuration to other amplifiers. A window will appear whereby the desired filename for the configuration can be selected and the system backup will be saved as ...AUDAC\SETTINGS\FILENAME.SET

## General setup >> USB >> Load

Different types of configuration files can be loaded into the amplifier, such as loudspeaker presets (\*.SPF), complete set solution configurations (\*.SOL) and system backups (\*.SET). Each of above configuration files have their own filetype and will be loaded in a different way. When pressing the load button, a window will appear whereby browsing through the files on the inserted medium is made possible. Browsing through folders is possible through turning the rotary dial, lower folders can be easily accessed by selecting them while both top options allow to browse up or to the root of the inserted medium. After the desired file has been found, it can be loaded by selecting it.

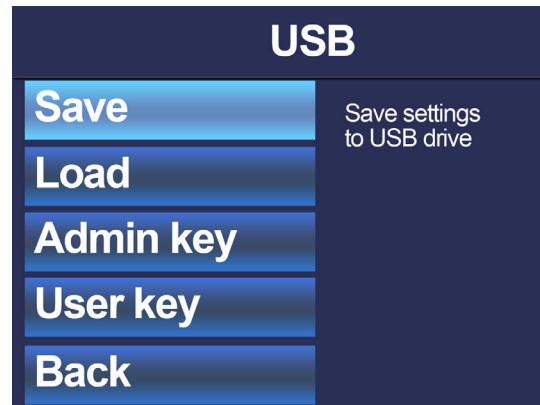

Speaker presets are files in \*.SPF format which are prepared and provided by AUDAC and containing all parameters for optimal performance and protection for the corresponding loudspeaker. When a \*.SPF file is loaded, the amplifier will recognize their filetype and show a popup window wherein all channels can be selected on which this file should be applied (whereon the corresponding loudspeaker is connected). After the selected channels are selected, the ‘load settings’ button shall be pressed and the presets will be loaded to the selected channels. All previously made EQ settings are removed when an \*.SPF file is loaded.

Complete system configurations (set solutions) are files in \*.SOL format which are prepared and provided by AUDAC. These files contain parameters for a complete configuration consisting of multiple (with different types) loudspeakers, such as a combination of loudspeaker cabinets with a bass cabinet, ... These configuration files contain besides the protection and performance parameters also information about connected channels, bridging, filtering, etc. Additional comments about system configurations are shown on the right side of the browse window. When a \*.SOL file is selected, it will be immediately loaded without requiring selection of the channels where it should apply to. All previously made EQ and filter settings are removed when an \*.SOL file is loaded.

System backups are files in (\*.SET) format which can be created by the customer themselves. When a system backup is made using the 'save' action as shown above, it will be saved as a (\*.SET) file which can be re-loaded in similar way as a \*.SOL file. It will be immediately loaded without requiring channel selection where it should apply to.

## General setup >> USB >> Key

An USB key with both administrator and user level access can be created when selecting the corresponding buttons. A file containing the configured password information will be stored to the inserted medium, providing instant access to the functions when the medium is inserted. This will allow instant and easy access in any circumstance and will also eliminate the possibility that someone's peeking the password.

## General setup >> Info

The info screen gives an overview of the amplifier model and the software version which it is currently running.

## General setup >> Temperature

The temperature screen indicates the current operating temperature for each individual amplifier channel.

## General setup >> Factory reset

Factory reset will recall all settings to factory defaults and all previously made settings and configurations will be lost.

After pressing the factory reset button, a confirmation will be asked if all settings definitely need to be reset to factory defaults. When confirmed, all settings will be lost.

## Save

All currently set values for output levels, selected inputs and channel muting will be saved when selected. After power down and restart the amplifier, these saved values will be automatically reloaded. Other configuration settings (except output levels, inputs and muting) are automatically saved when modified, whereby they will be automatically recalled after power down and restart.

## Lock

When selected, the amplifier will be locked and a password (when configured) will be required before any access is given to the user interface of the amplifier.

# Chapter 6

## Additional information

### Technical specifications

RMS Output Power (1 kHz, THD 1%)	PMQ240	@ 100 Volt	4 x 240 Watt
		@ 8 Ω	4 x 240 Watt
	PMQ480	@ 100 Volt	4 x 480 Watt
		@ 8 Ω	4 x 480 Watt
	PMQ600	@ 100 Volt	4 x 600 Watt
		@ 8 Ω	4 x 600 Watt
Min load impedance	PMQ240	@ 100 Volt	41.7 Ω
		@ 8 Ω	8 Ω
	PMQ480	@ 100 Volt	20.8 Ω
		@ 8 Ω	8 Ω
	PMQ600	@ 100 Volt	16.7 Ω
		@ 8 Ω	8 Ω
Frequency response			20 Hz – 20 kHz
Signal to Noise Ratio			> 95 dB
Total Harmonic Distortion + Noise			< 0.05%
Common Mode Rejection			70 dB
Crosstalk			> 70 dB
Inputs	Type		<b>Balanced Line</b>
	Connectors		Female XLR Input 3-pin Terminal block ~ 3.81 mm
	Impedance		10 k Ohm balanced
	Sensitivity		-30 dB ~ +5 dB
Output	Type		<b>Loudspeaker Output</b>
	Connectors		4-pin Terminal Block ~ 5.08 mm
Controls			DSP configuration through front panel RS-232
Indicators			Power Protect Peak -20 dB Signal
Protection			DC-Short Circuit Over Heating Over Load Limiter
Cooling system			Temperature controlled fan

Amplifier technology			Class–D
Power supply	Type	Switching mode	
	Range	230 V AC / 50 Hz	
Power consumption	Standby	PMQ240/480/600	~ 26 Watt
	Idle	PMQ240/480/900	~ 63 Watt
	1/8 Rated Power	PMQ240	190 Watt
		PMQ480	329 Watt
		PMQ600	416 Watt
	1/3 Rated Power	PMQ240	426 Watt
PMQ480		732 Watt	
PMQ600		1000 Watt	





