

eve audio

SC3070

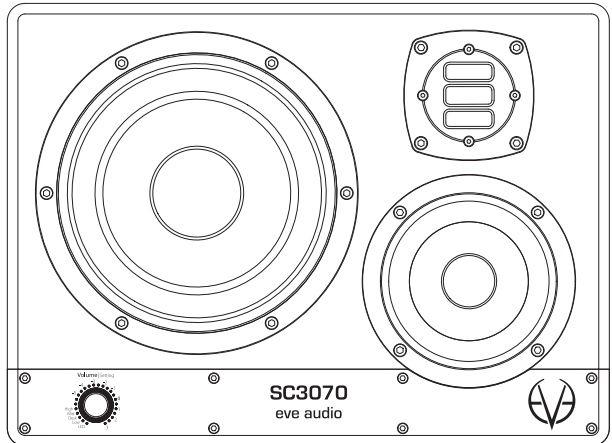

SAFETY INSTRUCTIONS

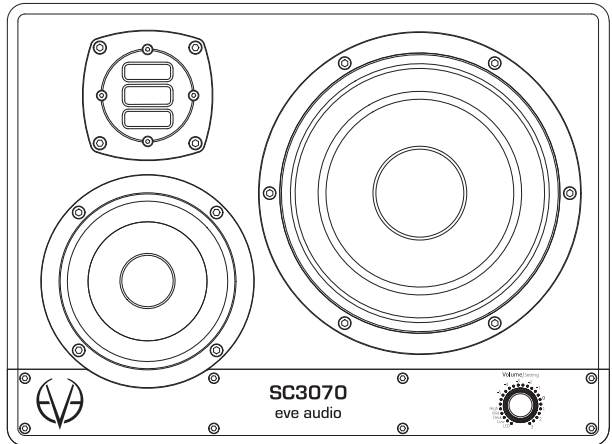

To avoid the risk of electrical shock, do not attempt to open the unit. There are no user-serviceable parts inside. Do not attempt to service the equipment yourself. In case of problems, please contact your local dealer or distributor.



This unit should be connected to a grounded power outlet. If you use extension cords and power distributors they should be grounded as well.



Verify that the specified operating voltage on the rear side matches the local mains voltage. If these values do not match you will have to adjust the loudspeaker setting appropriately and change the fuse type.



Use only the fuse types specified on the rear side of the unit. Never bypass the fuse.



Make sure that no liquids wet the inside of the cabinet. Never spray, pour or spill liquids directly onto the unit.



Do not use a wet cloth nor flammable or acid chemicals for cleaning.



Do not touch the diaphragms of the loudspeaker and do not obstruct the bass reflex ports.



Make sure there is enough air flow behind the loudspeaker to maintain the electronic components cool.



Do not expose this product to extreme temperatures.



The diaphragms build up a magnetic field around the loudspeaker.



High sound pressure levels can damage your hearing permanently! Avoid standing close to loudspeakers producing high sound pressure levels.

TABLE OF CONTENTS

- 1. INTRODUCTION4**
- 2. QUICK START5**
 - 2.1. First Steps5
 - 2.2. Speaker Connection5
 - 2.3. Powering On5
- 3. OPERATION6**
 - 3.1. First Steps6
 - 3.2. Left/Right Position7
 - 3.3. The Grid7
 - 3.4. Operating Modes8
 - 3.5. Powering on/off: Standby Mode8
 - 3.6. Volume Mode8
 - 3.7. Settings Menu10
 - 3.8. Filters10
 - 3.9. Low Filter10
 - 3.10. High Filter11
 - 3.11. Mid Filter11
 - 3.12. Desk Filter12
 - 3.13. LED Mode12
 - 3.14. Saving Your Settings13
 - 3.15. Power Switch13
 - 3.16. DIP Switches14
 - 3.17. Mains Voltage Selector14
 - 3.18. Power Connector (IEC)14
- 4. POSITIONING15**
 - 4.1. Speaker Positioning + Rubber Feet15
 - 4.2. Height and Distance15
 - 4.3. Stereo Setup16
 - 4.4. Stereo Setup + Subwoofer (2.1)17
 - 4.5. Multichannel Setup (5.1)17
 - 4.6. Mixer/Workplace Reflections18
 - 4.7. Room Acoustics20
- 5. TECHNICAL SPECIFICATIONS21**
- 6. COMPLIANCE22**
- 7. WARRANTY23**

1. INTRODUCTION

Thank you for your time and interest in the EVE Audio product range.

EVE Audio is a loudspeaker manufacturer based in Berlin, Germany, that specializes in the development and design of unique studio monitors.

The use of first-class components is our highest priority because we firmly believe this is the only way to manufacture first-class products.

You have chosen a loudspeaker from our Silvercone SC series. The SC3070 monitor was conceived as three-way system. Because of its asymmetrical design, the SC3070 monitor is available in left speaker and right speaker versions.

The mid-range driver guarantees an excellent definition in the mid frequencies, which raises this three-way system to a completely different listening level. The woofer reproduces the low-frequency range, while the mid-range driver and tweeter cover consecutive ranges.

The SC3070 studio monitor features EVE Audio's Air Motion Transformer taken from the RS series. The mid-range driver and the woofer sport a high-quality chassis developed by EVE Audio. The lot is completed by the implementation of high-resolution DSP technology plus powerful and efficient amplifiers.

We wish you a lot of fun with your EVE Audio monitors. If you have any questions regarding our products, do not hesitate to contact your nearest dealer or get directly in touch with us... We will be more than happy to help you out!

All the best from Berlin.

The EVE Audio Team

2. QUICK START

If you already have experience with studio monitors, the Quick Start guide ought to be more than enough to get you started.

For unexperienced users we recommend reading the whole user's manual in order to prevent any misuse.

2.1. First Steps

Check the package components (loudspeaker, user's manual, power cord, grille, rubber feet).

Check the voltage setting (see "Mains Voltage Selector").

Check the setting of the DIP Switches (variable).

2.2. Speaker Connection

Connect one of the monitor inputs on the rear side (RCA or XLR) to the line output of a playback source, for instance, an audio interface. The output level should be as low as possible.

2.3. Powering On

Engage the Power switch on the rear side of the loudspeaker to turn it on or off.

The LEDs around the Volume control on the front panel will light up clockwise. If the LED on the right end is dimly lit, this indicates that the loudspeaker is in Standby mode. Press the Volume control to turn the loudspeaker on. If you turn the Volume control counter clockwise until the LED on the left end lights up dimly the loudspeaker will be muted.

Increase the output level on the source device until the LED ring starts to blink, then reduce the output level a bit. The maximum operating level for the input (i.e. the analog to digital converter) is now set optimally. To set the desired listening volume use the Volume control on the loudspeaker. The LED ring indicates the volume setting. If the LED ring starts to blink, reduce the output level on the signal source.

3. OPERATION

3.1. First Steps

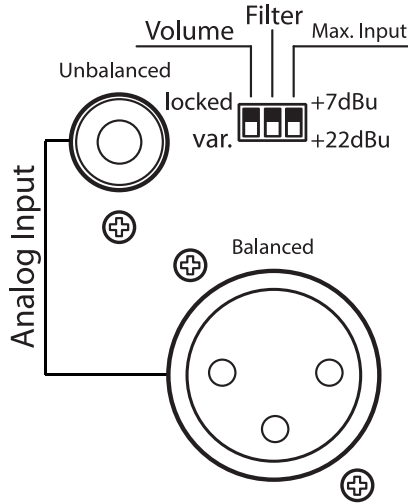

Rear Connections & DIP Switches

Check the package components (loudspeaker, user's manual, power cord, grille, rubber feet);

Check the voltage setting (see "Mains Voltage Selector").

Check the setting of the DIP Switches (variable).

Connections: there are two input connectors on the rear side. These allow the connection of balanced sources with XLR connectors or unbalanced sources with RCA connectors.

- Pin assignment XLR: 1 = Shield, 2 = hot (+), 3 = cold(-).
- Pin assignment RCA: Center conductor = Signal, Ring = Shield.

Both analog inputs can be used simultaneously, whereby the signals are summed.

Depending on the setting of the Max. Input DIP switch on the rear panel, the maximum level of the source signal should not exceed +7dBu or +22dBu (see Max. Input). If the input is overloaded the LED ring will start blinking.

3.2. Left/Right Position

The SC3070 is a 3-way studio monitor with asymmetrical design. For this reason, it is available in two different versions for the right side and the left side of the stereo field.

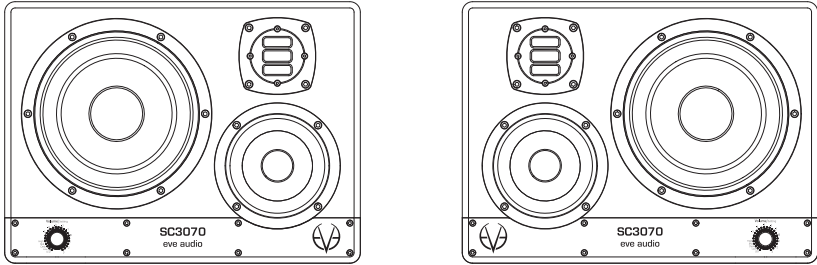

Best left/right SC3070 position for an optimal stereo field

For the right side of the stereo field, choose the SC3070 version whose woofer is on the right-hand side. For the left side of the stereo field, choose the SC3070 version whose woofer is on the left-hand side. In other words, the tweeter of each monitor should be placed on the inner side of the stereo field. This setup reduces the impact of reflecting surfaces between the tweeters.

In a narrow room, you may place the tweeters on the outer side of the stereo field in order to extend the width of the soundscape. However this might affect your ability to perceive the position of the signals in the sound field because of the increased reflections generated by the side walls.

3.3. The Grid

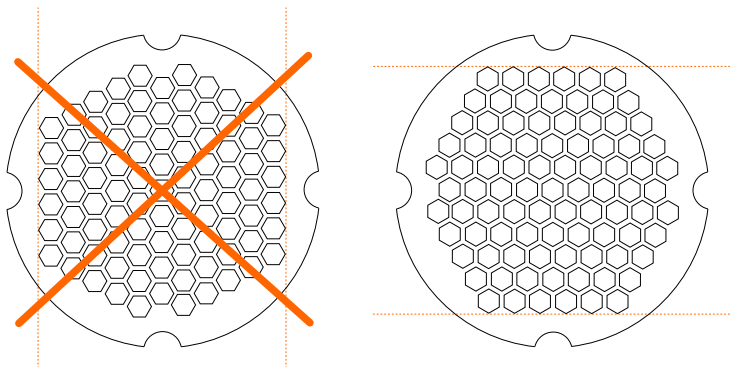

Wrong grid position < > Right grid position

In order to protect the tweeter, your EVE Audio monitors are supplied with a metal grid, which has no impact on the sound. The grid is attached to the tweeter by means of magnetic attraction.

Be careful not to damage the folded tweeter diaphragm when placing the grid: Hold the grille with your fingers parallel to the front side of the monitor. The perforated hexagon must exhibit two horizontal sides. Make sure that the grille remains parallel to the front side.

Draw the grille close to the tweeter. The tweeter's magnetic field will attract and fix the grille, which can always be adjusted later if needed.

3.4. Operating Modes

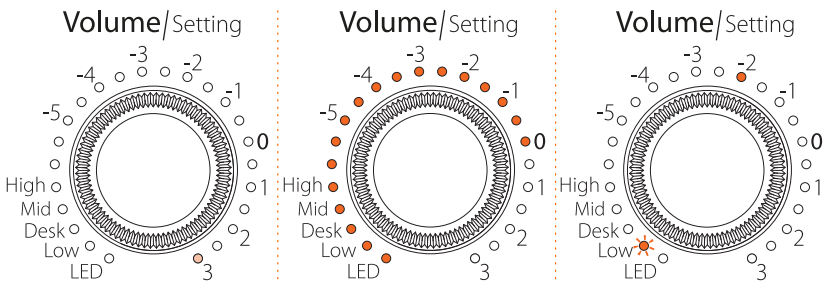

Standby mode | Volume mode (-10 dB) | Settings menu (Low Filter @ -2 dB)

3.5. Powering on/off: Standby Mode

Press and hold the control three seconds in order to put the monitor in Standby mode. The volume will decrease gradually while the LED ring lights up once around the Volume control. Afterwards, the LED on the right end will remain dimly lit and the power consumption is reduced to 1 watt.

! To exit the Standby mode press briefly the Volume control once again. The level will increase gradually.

3.6. Volume Mode

Level Adjustment

The maximum input level for balanced (XLR) and unbalanced signals (RCA) is +7dBu or +22dBu, depending on the position of the Max. Input switch on the rear panel (see DIP Switches). Higher levels produce distortion due to the overloading of the analog to digital converter.

Given that some professional studio devices can produce in excess of +22dBu, the LED ring will start blinking whenever the AD converter is

overloading. If that is the case, the output level of the source should be reduced.

Volume Adjustment

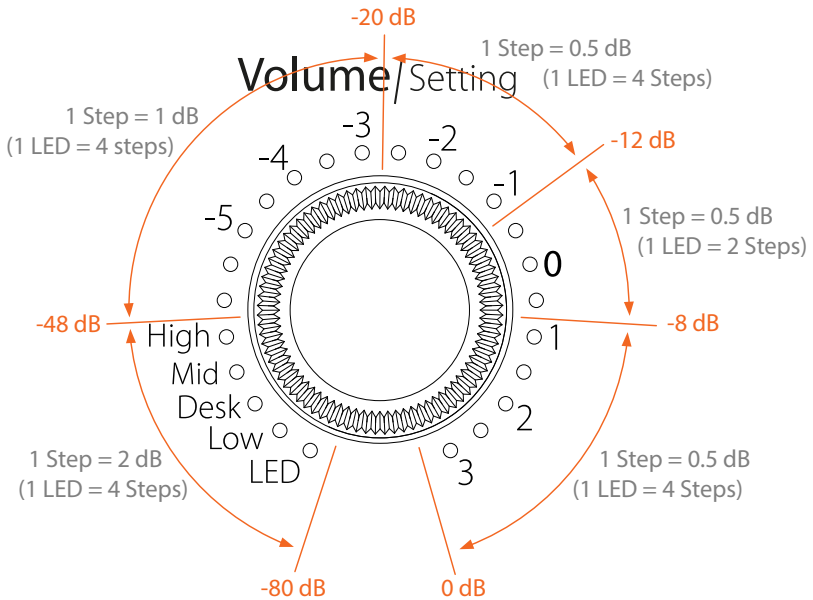

Turn the knob to adjust the volume. Depending on the LED mode selected (see LED mode), the volume will be displayed as a dim/bright circle or as a dim/bright point.

The control's response curve is not linear. The increments become finer as the volume increases:

- 80 dB (minimum) to -48 dB: 2 dB
- 48 dB to -20 dB: 1 dB
- 20 dB to 0 dB (maximum): 0.5 dB

Mute

To mute the monitor, turn the Volume control counter clockwise until you reach the minimum level. When the LED on the left end lights up dimly the Mute mode is activated.

To exit the Mute mode simply turn the control clockwise until you reach the desired volume.

3.7. Settings Menu

Press the control once to enter the Settings menu. Here you can set four different filters (High, Mid, Desk, Low), as well as the LED ring's behavior. The LED of the currently active function will blink.

Turn the control to choose the filter or LED mode desired. The blinking LED indicates the function selected, while the steady-on LED indicates the value assigned to that function.

Press the control to confirm your selection. The blinking will stop once the selection is confirmed.

Turn the control to adjust the filter or the LED behavior.

When you are satisfied with the setting, press the control again to go back to the Settings menu. You can then select and edit another function.

! To exit the Settings menu press and hold the control for three seconds or simply wait 10 seconds. The loudspeaker will then return automatically to the Volume mode.

3.8. Filters

The filters of the EVE Audio monitors were specially developed to offer you the possibility of adjusting your monitoring system to the characteristics of your room. These filters help correct the alterations to the frequency response produced by the room acoustics and listening distance. Do bear in mind that correcting bad room acoustics with filters will only achieve average results. In any case, you should try to use the filters as little as possible.

3.9. Low Filter

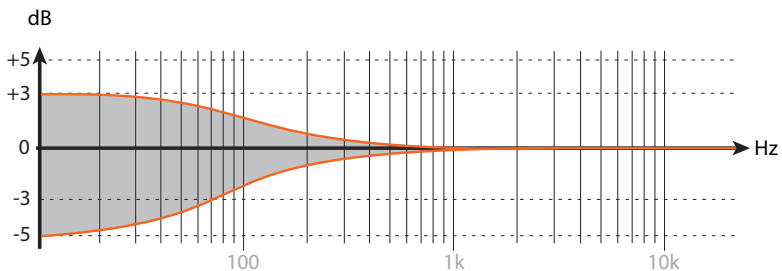

The Low-Shelf Filter allows you to boost or attenuate frequencies below 300Hz in 0.5dB steps. Use this filter whenever the acoustics of your room cause problems in the low frequency range.

If the low frequencies are boosted by the room, you can attenuate them with the Low-Shelf Filter. The reasons for this boost could be the room modes or the loudspeakers being too close to the walls. In the same way, if the low frequencies are too weak, you can boost them to balance the frequency response.

3.10. High Filter

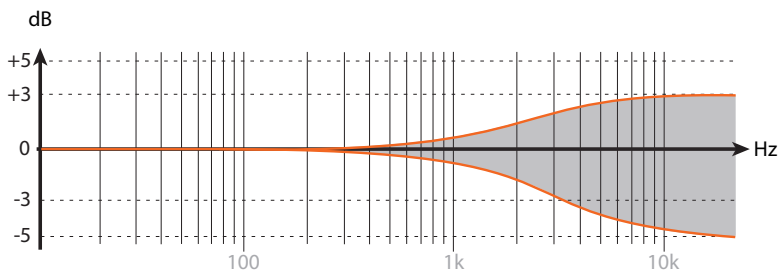

The High-Shelf Filter allows you to boost or attenuate frequencies above 3kHz in 0.5dB steps. High frequencies are affected depending on the distance from the sound source to the listening position. The further you are from the loudspeakers, the weaker the high frequencies. In such cases the filter should be set to boost them. In desktop applications, distances can be as short as 1m (3ft), which results in the high frequencies being boosted. To compensate for this effect you should use the High-Shelf Filter to attenuate the high frequencies.

If you have a very dead room, it might be wise to boost the high frequencies in order to have a more balanced overall sound. When the listening position is too close to the loudspeakers or the room has reflective surfaces, it is reasonable to attenuate the high frequencies.

3.11. Mid Filter

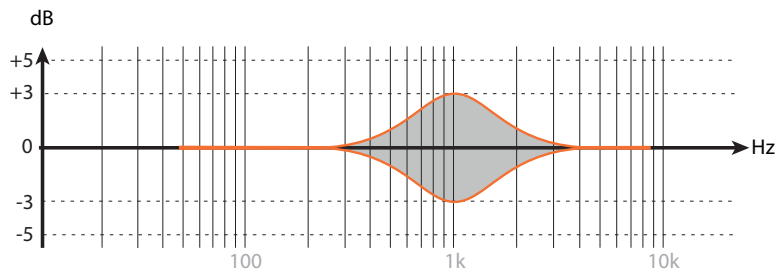

The Mid Filter is a bell filter with 1kHz center frequency. It allows you to boost or cut the mid range up to +/-3dB in 0.5dB steps.

This frequency range is very important for the balance between lower mid and higher mid frequencies. Use the Mid filter to adjust the balance between fundamental and harmonic frequencies in the music material. Depending on the acoustics of your room, some of the sound energy produced by the monitors may be reflected by surfaces like walls, floor and/or ceiling in the room, thus altering the perceived sound.

3.12. Desk Filter

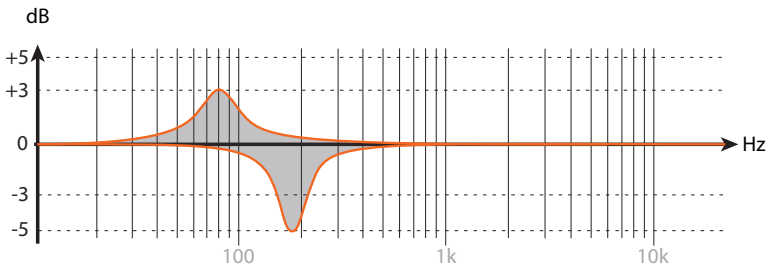

The Desk Filter has two functions. When turned down it acts as a narrow-band EQ set to 160Hz.

The reflections of mixers and similar surfaces usually result in the boosting of low mids. With the Desk Filter you can lessen this effect by turning down the filter gain.

When turned up, the Desk Filter also works as an EQ but this time set to 80Hz. This allows you to give more punch to the lower frequencies.

!

The following applies to the Low, High and Desk filters:

- Every step represents a 0.5dB increment.
- Maximal boost is +3dB and maximal attenuation is -5dB.
- Refer to the chapter on POSITIONING to set the filters of your EVE Audio monitors effectively.

3.13. LED Mode

The LED mode determines in which of the four available fashions the LED ring displays the volume level. The LEDs represent given levels, which are displayed and adjusted according to four steps. Intermediate steps are indicated by the brightness between two adjacent LEDs.

- **Bright Ring**
All LEDs up to the selected volume level light up brightly. The louder the signal, the longer the brightly lit-up ring.
- **Bright Point**
Only the LEDs corresponding to the selected volume level light up brightly. The louder the signal, the further up the brightly lit-up point moves.
- **Dimly Lit Ring**
All LEDs up to the selected volume level light up dimly. The louder the signal, the longer the dimly lit-up ring. In this mode, the LEDs light up brightly momentarily while you adjust the volume level.
- **Dimly Lit Point**
Only the LEDs corresponding to the selected volume level light up dimly. The louder the signal, the further up the dimly lit-up point moves.
- ! Intermediate steps are indicated by the lighting of two adjacent LEDs. The level ranges from -60dB to +10dB, taking "0dB" as reference point.

3.14. Saving Your Settings

All settings on the front and rear panels are automatically saved. The loudspeakers can be disconnected anytime without the settings being lost.

3.15. Power Switch

The power switch on the rear panel disconnects the loudspeaker completely from the power grid. When powered off all settings are saved and the power consumption is reduced to 0 watt.

After powering on again, the loudspeaker will return to the state it was in before being turned off (Standby mode, Mute mode or a given volume level). Even if powered off via a multiple outlet power strip, the monitor will return to the state it was in before being turned off.

- ! In order to prevent switching noise with your monitoring system, keep in mind the following rules:
Power all audio sources on first and your loudspeakers last.
When turning off your system, power off your loudspeakers first and then all audio sources.

3.16. DIP Switches

On the rear panel of your EVE Audio monitors you will find three DIP Switches. These allow you to secure your loudspeaker settings to prevent them from being changed inadvertently.

- **Volume**

When set to “lock,” this DIP Switch secures the current volume setting. The LED ring on the front panel indicates the volume setting, but it cannot be modified. When set to “variable,” the volume setting can be changed by simply turning the knob.

- **Filter**

When set to “lock,” this DIP Switch secures the current filter settings. The filter settings can be read on the LED ring, but they cannot be modified. When set to “variable,” the filters can be modified freely.

- **Max. Input**

This DIP Switch determines the input sensitivity of the SC3070. In a studio environment, the reference level (0dB) ought to be 4dBu. In such environments, leave the setting at “+7dBu.” However, some studio gear allow much higher output levels. If it were impossible to reduce the output level of such devices, set the switch to “+22dBu.”

The “+7dBu” setting ought to be suitable for most situations.

3.17. Mains Voltage Selector

The Mains Voltage Selector allows you to adjust the operating voltage of your EVE Audio monitors to the local power grid. Set it to “230” if your local power grid is 220-240 volts or “115” if it is 110-120 volts.

If you change the mains voltage value you also have to replace the fuse of the IEC connector with an appropriate one. The corresponding fuse values are printed on the unit underneath the IEC connector.

3.18. Power Connector (IEC)

Use the power cord supplied to connect your EVE Audio monitors to the power grid. The IEC connector includes an integrated fuse. If your EVE Audio monitors stop working and the fuse seems to be the problem, proceed as follows:

- Turn the loudspeaker off.
- Disconnect it from the power grid.
- Detach the IEC connector from the unit.

- Remove the fuse.
- Change the fuse. The replacement fuse should comply with the values stated on the subwoofer.

4. POSITIONING

4.1. Speaker Positioning + Rubber Feet

Ideally, there should be no objects or obstacles between the loudspeakers and the listening position. Furthermore, a symmetrical positioning is important. This applies to the distance between speakers as well as to the walls, ceiling and floor. In order to have a symmetrical stereo image it is also important to have symmetrical reflections. We recommend to keep a distance of at least 0.5m (19 inches) to the walls, in order to avoid low frequency boosting.

EVE Audio monitors can also be flush-mounted in a wall, in which case there should be enough air flow. This is important to keep the electronic components cool but also to allow for the best performance of the bass reflex ports. We recommend to keep at least 3cm (1 in) to the sides and top.

The SC3070 monitor was designed to be placed horizontally.

Rubber feet: your EVE Audio monitors are supplied with four self-adhesive rubber feet. Fix them to the bottom of your loudspeakers to place the monitors safely on an even surface. Furthermore, the rubber feet improve the acoustic decoupling of the loudspeakers from the surface.

4.2. Height and Distance

The tweeter of your EVE Audio monitors should be ideally placed at the same height as your ears. If this is not possible tilt the monitors so that the tweeter is directed to your ears.

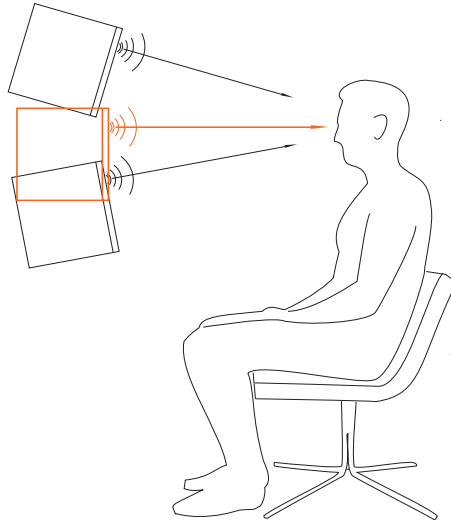

The ideal distance between the SC3070 monitors and the listening position is 1-3 m (3.3-10 ft).

!

These values are only meant as a reference and depend a lot on the characteristics of the room. In live rooms you will be forced to reduce the distance, while in dead rooms the distance to the loudspeakers can be larger.

4.3. Stereo Setup

The tweeter of your EVE Audio monitors should be ideally placed at the same height as your ears. If this is not possible tilt the monitors so that the tweeter is directed to your ears.

The ideal distance between the SC3070 monitors and the listening position is 1-3 m (3.3-10 ft).

The so-called "stereo triangle" is the best way to place speakers in a stereo setup, i.e. the monitors and the listening position should form an equilateral triangle. Try the following:

Establish the ideal distance to the listening position (see "Height & Distance").

Place the monitors in such a way that the distance from each other and to the listening position is the same.

Turn both monitors so that their front panels are pointed towards the listening position (all angles of the stereo triangle should be 60°).

4.4. Stereo Setup + Subwoofer (2.1)

In such a setup, the subwoofer is fed by the stereo signal source. The subwoofer filters the low frequency components of the stereo channels and sums them to produce a mono signal, which it then reproduces. The high frequencies are forwarded to the full-range satellite speakers.

Ideally, such a system would comprise two EVE Audio SC3070 monitors plus one EVE Audio TS110 or TS112 subwoofer, or even two TS108 subwoofers. All these subwoofers allow you to set the crossover frequency for the satellite speakers and the subwoofer.

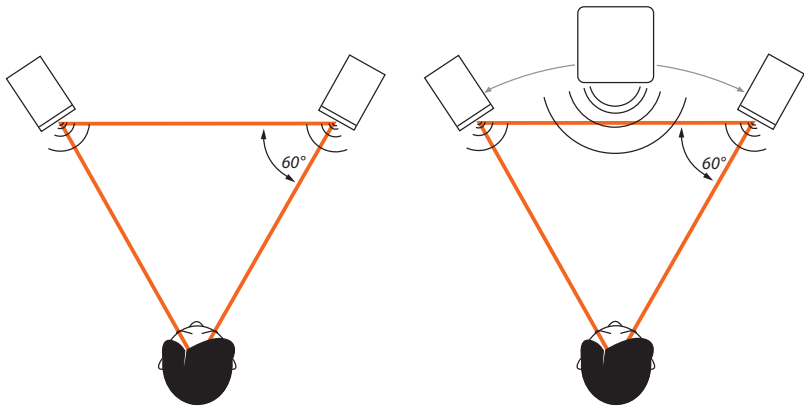

Stereo Setup (left) and Stereo Setup + Subwoofer (right)

The positioning of the two satellites should be done in the same manner as in a stereo setup (see “Stereo Setup”).

The subwoofer should be placed on the ground between both satellites. Considering that low frequencies are omnidirectional, the subwoofer does not have to be centered exactly between the two satellites. The subwoofer can be moved back a bit so that it is at the same distance from the listening position as the satellites. This guarantees all transducers are aligned in time.

4.5. Multichannel Setup (5.1)

The most common 5.1 systems consist of three front channels (left, right and center), two surround channels (left/right) and a subwoofer for the low frequencies. The speakers from a circle around the listening position.

Ideally, a 5.1 system would comprise four EVE Audio SC3070, one EVE Audio SC407 as the center speaker plus an EVE Audio TS110 or TS112 subwoofer.

The positioning of the two front speakers and the subwoofer should be

done in the same manner as in a stereo setup with a subwoofer (see “Stereo Setup + Subwoofer”).

Place the center monitor directly in front of the listening position, i.e. right in the center between both front satellites.

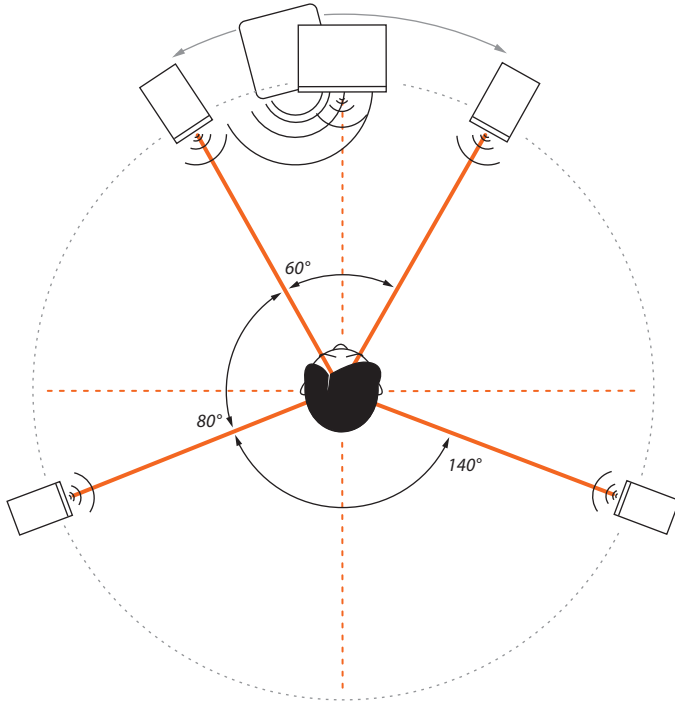

The rear satellites should form an isosceles triangle with the listening position forming an angle of 140°.

Verify that all speakers are at the same distance from the listening position, so that they are aligned in time.

4.6. Mixer/Workplace Reflections

Regardless of whether the monitors are to be used in a recording studio with a mixing desk and meter bridge or in a desktop environment, hard surfaces can produce annoying reflections that alter the natural reproduction of the loudspeakers. Especially in the low-mid frequency range.

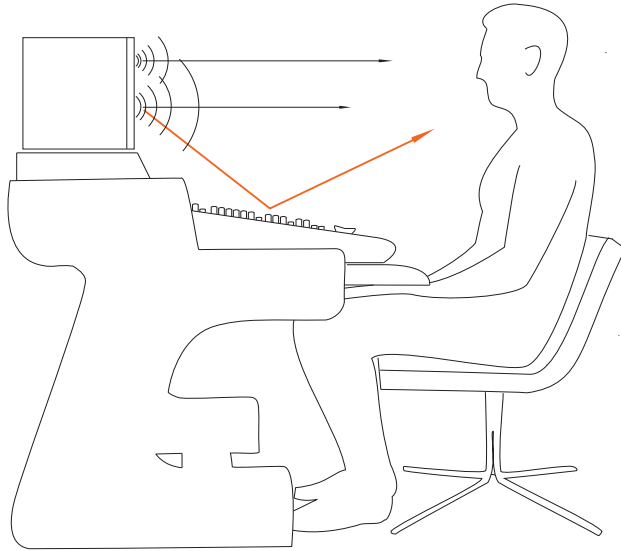

If this is the case with your setup, use the Desk Filter of your EVE Audio monitors to reduce the impact of the reflections from the desk or mixer.

4.7. Room Acoustics

In order for the described measures to work effectively, we recommend that you put special attention to the room acoustics. The size, contents, wall parallelism, proportion, and reflective behavior of the room, as well as the corners, the building materials and their characteristics play a very important role in the acoustics of a room.

Room acoustics is a science in itself and it is unfortunately out of the scope of this manual. However, we have put together a short bibliography for you:

- "Recording Studio Design" by Philip Newell. ISBN: 0-240-51917-5
- "Home Recording Studio – Build it like the Pros" by Rod Gervais. ISBN: 1-59863-034-2
- "Studio Akustik" (in German) by Andreas Friesecke. ISBN: 978-3-932275-81-4
- "Praktische Raumakustik" (in German) by Thomas Hentschel. ISBN 978-3-8364-6800-8
- "Handbuch der Tonstudioteknik" Book 1 (in German) by Michael Dickreiter. ISBN 3-598-11321-8
- "Handbuch der Audiotechnik" (in German) by Stefan Weinzierl (Ed). ISBN 978-3-540-34300-4

5. TECHNICAL SPECIFICATIONS

Product	SC3070
Description	3-way Monitor
Dimensions (WxHxD) (mm)	340 x 250 x 310
Dimensions (WxHxD) (")	13.39 x 9.84 x 12.22
Frequency Range (-3dB)	35Hz - 25kHz
Tweeter	AMT RS3
Woofers	165mm / 6.5"
Mid Driver	100mm / 4"
Crossover Frequencies	320Hz/2,800Hz
Maximum SPL @ 1m	110dB
Number of Amplifiers	3
Total Output Power (short term)	335W
Output Power (woofer)	185W
Output Power (Mid Driver)	100W
Output Power (tweeter)	50W
Limiter	Yes
Setting Options	
Volume	-inf. – +6dB
High-Shelf Filter (-5db – +3dB)	> 3kHz
Mid Filter (-3db – +3dB)	1kHz
Desk Filter Boost (0db – +3dB)	80Hz
Desk Filter Cut (-5db – 0dB)	160Hz
Low-Shelf Filter (-5db – +3dB)	< 300Hz
Volume Lock	Yes
Filter Lock	Yes
Input Level Switch	+7dBu / +22dBu
Connections	
XLR Input (impedance)	Yes (10kΩ)
RCA Input (impedance)	Yes (10kΩ)
Power Consumption	
Standby	< 1W
Maximum	220VA
Miscellaneous	
Weight kg / lb.	9.8 / 21.6

6. COMPLIANCE

We,
EVE Audio GmbH,
with registered office in
Ernst Augustin Str. 7, 12489 Berlin, Germany,
herewith declare that the
SC3070 product
complies with the following norms:

EC Norms:

EN 60065: 2002 + A1:2006 + A11:2008 + A2:2010 + A12:2011
EC Regulation 1275/2008: 2008-12-18
EN 62301: 2005

EMC Norms:

EN 55013: 2001 + A1:2003 + A2:2006
EN 55020: 2007 + A11:2011
EN 61000-3-2: 2006 + A1:2009 + A2:2009
EN 61000-3-3: 2008

This declaration certifies that the quality control and product documentation complies with the current corresponding EU directives.

Issued in Berlin.

Signature



Roland Stenz
Managing Director EVE Audio

7. WARRANTY

- ▷ The manufacturer warranty is valid for a period of two (2) years after the date of purchase.
- ▷ The warranty covers repair costs (labor and spare parts), product replacement if applicable, and return transport within the country where the product was bought.
- ▷ The warranty will be void if any of the following applies:
 - Damages have been caused by incorrect installation and/or connection,
 - Damages have been caused by misuse or negligence,
 - The unit has been tampered with or modified in any way,
 - The unit has been repaired or modified by unqualified personnel,
 - Damages have been caused by factors beyond the reasonable control of EVE Audio (lightning, fire, flood, etc.)
- ▷ Always keep the original packaging of any EVE Audio product: Only products with original packaging are eligible for warranty service. If the product is not packaged in its original box, EVE Audio will not be liable for any damages occurred during transit.
- ▷ Should service be required during or after the warranty period, please contact your local EVE Audio dealer or distributor.



EVE AUDIO GmbH

 Ernst Augustin Str. 7,
12489 Berlin, Germany

 +49-30-6704 4180

 +49-30-6704 4188

 info@eve-audio.com

 www.eve-audio.com

 facebook.com/EveAudio

 twitter.com/EveAudio