

# TASCAM

# US-2x2HR

# US-4x4HR

## USB Audio/MIDI Interface

**REFERENCE MANUAL**

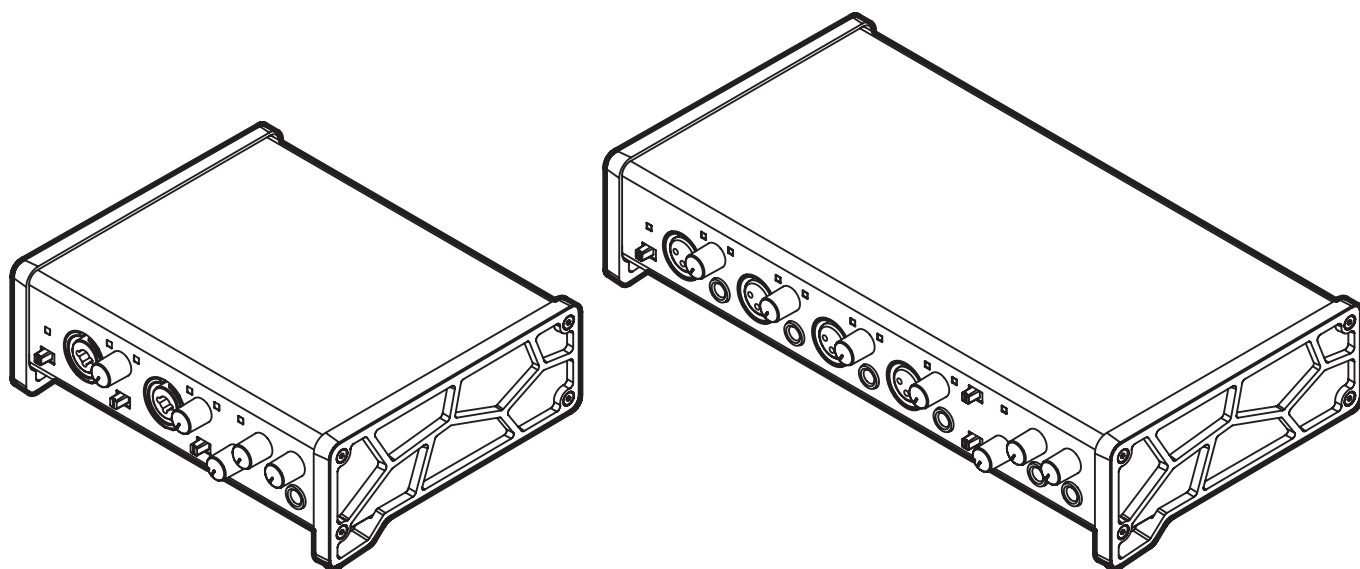

Before connecting this unit to a computer, you must download and install dedicated software on the computer.

# Contents

|   |           |                                    |           |
|---|-----------|------------------------------------|-----------|
| <b>1 – Introduction .....</b>                         | <b>3</b>  | <b>10 – Specifications .....</b>   | <b>22</b> |
| Features .....  | 3         | General .....                      | 22        |
| Conventions used in this manual .....                 | 3         | Input/output ratings .....         | 22        |
| Trademarks .....                                      | 3         | Analog inputs .....                | 22        |
| <b>2 - Names and Functions of Parts .....</b>         | <b>4</b>  | Analog outputs .....               | 22        |
| Front panel .....                                     | 4         | Control input/output ratings ..... | 22        |
| Rear panel .....                                      | 5         | Audio performance .....            | 22        |
| <b>3 – Installation .....</b>                         | <b>6</b>  | Computer system requirements ..... | 23        |
| System requirements .....                             | 6         | Windows .....                      | 23        |
| Windows .....   | 6         | Mac .....                          | 23        |
| Mac .....   | 6         | iOS device .....                   | 23        |
| Apple iOS devices .....                               | 6         | Supported audio drivers .....      | 23        |
| Supported audio drivers .....                         | 6         | Other .....                        | 23        |
| Installing the dedicated software .....               | 7         | Dimensional drawings .....         | 24        |
| Installing the Windows dedicated software .....       | 7         | Block diagram .....                | 25        |
| Installing the Mac dedicated software .....           | 8         |                                    |           |
| Working with Gatekeeper .....                         | 8         |                                    |           |
| Uninstalling the dedicated software .....             | 9         |                                    |           |
| Uninstalling the Windows dedicated software .....     | 9         |                                    |           |
| Uninstalling the Mac dedicated software .....         | 9         |                                    |           |
| <b>4 – Preparation .....</b>                          | <b>10</b> |                                    |           |
| Connecting the power .....                            | 10        |                                    |           |
| When using a computer (Windows/Mac) .....             | 10        |                                    |           |
| When using an iOS device .....                        | 10        |                                    |           |
| Using with an AC adapter .....                        | 10        |                                    |           |
| Changing the outlet plug (US-4x4HR only) .....        | 11        |                                    |           |
| Connecting other equipment .....                      | 11        |                                    |           |
| Connecting with a computer .....                      | 12        |                                    |           |
| Connecting with iOS devices .....                     | 12        |                                    |           |
| Audio connections .....                               | 12        |                                    |           |
| MIDI connections .....                                | 13        |                                    |           |
| Using direct monitoring .....                         | 13        |                                    |           |
| <b>5 – Using the Settings Panel .....</b>             | <b>14</b> |                                    |           |
| Opening the Settings Panel .....                      | 14        |                                    |           |
| Windows .....   | 14        |                                    |           |
| Mac .....   | 14        |                                    |           |
| Settings Panel overview .....                         | 14        |                                    |           |
| Notification function .....                           | 16        |                                    |           |
| Checking software and firmware versions .....         | 16        |                                    |           |
| Automatic software and firmware update function ..... | 16        |                                    |           |
| <b>6 – Application Guide .....</b>                    | <b>17</b> |                                    |           |
| DAW software .....                                    | 17        |                                    |           |
| Bundled DAW software .....                            | 17        |                                    |           |
| Other DAW software .....                              | 17        |                                    |           |
| Windows .....   | 17        |                                    |           |
| macOS .....   | 17        |                                    |           |
| iOS .....   | 17        |                                    |           |
| <b>7 – Standalone Mode .....</b>                      | <b>18</b> |                                    |           |
| Overview .....  | 18        |                                    |           |
| Settings in standalone mode .....                     | 18        |                                    |           |
| Settings Panel settings .....                         | 18        |                                    |           |
| <b>8 – MIDI Implementation Chart .....</b>            | <b>19</b> |                                    |           |
| <b>9 – Troubleshooting .....</b>                      | <b>20</b> |                                    |           |

---

## Features

---

### US-2x2HR

- 2 combo XLR/TRS input jacks
- 2 Ultra-HDDA (High Definition Discrete Architecture) mic preamps with clear, natural sound quality and super-low noise
- TRS analog output jacks (LINE OUT 1-2)
- 1 headphone output

### US-4x4HR

- 4 pairs of XLR and TRS inputs
- 4 Ultra-HDDA (High Definition Discrete Architecture) mic preamps with clear, natural sound quality and super-low noise
- TRS analog output jacks (LINE OUT 1-4)
- 2 headphone outputs

### US-2x2HR and US-4x4HR

- Support for high resolution formats up to 24-bit/192kHz
- Capable of providing +48V phantom power
- Support for direct input of guitars, basses and similar instruments
- MIDI input and output connectors enable connection with keyboards and other MIDI devices
- Direct monitoring function allows input monitoring with low latency
- Loopback function that supports stereo/mono switching of inputs and outputs (on Windows/Mac)
- USB Type-C port (USB 2.0 standard)
- Support for operation on USB bus power
- US-HR Settings Panel control software has a simple, functional design and enables making unit settings
- High-performance driver can be set to minimal buffer sizes and enables recording setups with super-low latency (Windows)
- Angled design provides excellent usability on a desktop
- Valuable bundled software
- Connect with iOS devices including iPad

### Note about computer operation

If you are unsure about anything related to the basic operation of a computer when it is mentioned in an explanation in this manual, please refer to the computer operation manual.

To use this unit with a computer, dedicated software must be installed on the computer.

For details about software installation, see “Installing the dedicated software” on page 7.

---

## Conventions used in this manual

---

In this manual, we use the following conventions:

- Information shown on a computer display is written like this: “OK”.
- References to “iOS” in this document also include “iPad OS”.
- As necessary, additional information is provided under TIP, NOTE and CAUTION headings.

#### TIP

These are tips about how to use the unit.

#### NOTE

These provide additional explanations and describe special cases.

#### ATTENTION

Failure to follow these instructions could result in damage to equipment or lost data, for example.

#### CAUTION

Failure to follow these instructions could result in injury.

---

## Trademarks

---

- TASCAM is a registered trademark of TEAC Corporation.
- Microsoft and Windows are either registered trademarks or trademarks of Microsoft Corporation in the United States and/or other countries.
- Apple, Mac, macOS, iPad and iPadOS are trademarks of Apple Inc. in the United States and other countries.
- Lightning is a trademark of Apple Inc.
- App Store is a service mark of Apple Inc.
- IOS is a trademark or registered trademark of Cisco in the U.S. and other countries and is used under license.
- ASIO is a trademark of Steinberg Media Technologies GmbH.



- Other company names, product names and logos in this document are the trademarks or registered trademarks of their respective owners.

# 2 - Names and Functions of Parts

## Front panel

### US-2x2HR

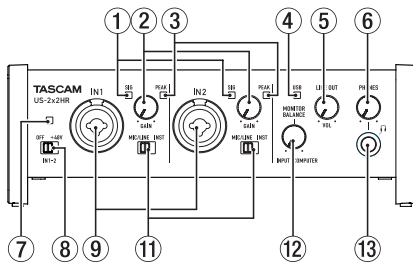

#### ① SIG indicators

These light green when signals (of at least  $-32$  dBFS) are input.

#### ② GAIN knobs

Use to adjust the input levels of the input jacks. Adjust these so that the PEAK indicators do not light red.

#### ③ PEAK indicators

These light red when signals are about to distort ( $-1$  dBFS or higher).

#### ④ USB indicator

This lights when the USB connection is working.

#### ⑤ LINE OUT knob

Use to adjust the output level of the LINE OUT (BALANCED) 1-2 (15) jacks on the back of the unit.

#### ⑥ PHONES knob

Use to adjust the output level of the PHONES jack (1 and 2 jacks on US-4x4HR).

#### ⚠ CAUTION

Before connecting headphones, minimize the volume with the PHONES knob. Failure to do so could result in a sudden loud noise that could harm hearing, for example.

#### ⑦ Phantom power indicator

The indicator lights when the phantom power switch is set to +48V.

#### ATTENTION

When operating the US-4x4HR with USB bus power, use a commercially-available Type-C–Type-C cable to connect it to a USB Type-C port on the computer. If there is a problem with the power supply, the phantom power indicator will blink. In this case, use the included AC adapter (PS-P1220E, DC12 V).

#### ⑧ Phantom power switch

Use this switch to provide +48 V phantom power to the IN1 and IN2 XLR jacks (and IN3/IN4 on the US-4x4HR). (see “Connecting microphones” on page 12)

#### ⚠ CAUTION

Set the LINE OUT and PHONES knobs to their minimum values before changing the phantom power setting. Depending on the connected mics, sudden loud noises from monitoring equipment could occur, and this could damage the equipment or harm hearing.

### US-4x4HR

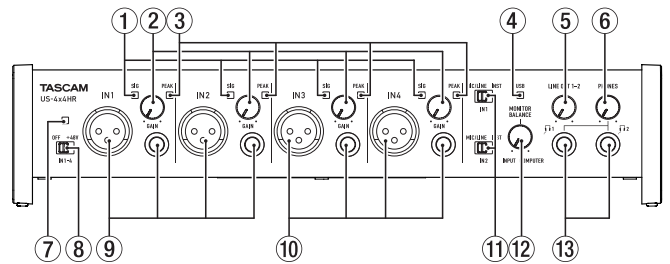

#### ⑨ IN1/IN2 jacks

On the US-2x2HR, these are XLR/TRS combo jacks for analog input.

On the US-4x4HR, these are separate XLR and standard TRS jacks for analog input. These support high impedance input, including direct guitar input.

Use the MIC/LINE INST switches (11) on the front of the unit to enable balanced line (MIC/LINE) input or unbalanced (INST) input for the standard TRS jacks.

When directly connecting a guitar, bass or other instrument, set the MIC/LINE INST switch (11) to INST.

#### ⑩ IN3/IN4 jacks (US-4x4HR only)

These XLR analog mic input and standard line level TRS jacks are balanced input jacks.

#### NOTE

On the US-4x4HR, IN1/IN2 (9) and IN3/IN4 (10) inputs each have two jacks (XLR and TRS). Do not input signals through both jacks of the same input at the same time. If signals are input through both at the same time, neither signal will be received properly.

#### ⑪ MIC/LINE INST switches

Set according to the IN1/IN2 jack input sources.

Set to MIC/LINE when connecting an electronic instrument, audio device, mic or similar equipment.

Set to INST when connecting a guitar, bass or other equipment with high output impedance.

#### ⑫ MONITOR BALANCE knob

When the Settings Panel LINE OUT 1-2 or LINE OUT 3-4 setting is Monitor Mix, use this to adjust the monitoring balance between the input signals from the input jacks and the output signals from the computer. (see “Using direct monitoring” on page 13)

The volume of signals input through this unit’s input jacks increase the more the MONITOR BALANCE knob is set to the left (INPUT) and signals output from the computer increase the more this is set to the right (COMPUTER).

This knob does not affect the recording level of input signals.

#### ⑬ PHONES jack

Use this standard stereo phone jack to connect stereo headphones. (Use 1 and 2 jacks on US-4x4HR.)

These output the same signals as the LINE OUT (BALANCED) 1-2 jacks.

Use an adapter to connect headphones with a mini plug.

#### NOTE

The same signals are output from both the 1 and 2 jacks of the US-4x4HR.

## 2 - Names and Functions of Parts

### Rear panel

#### US-2x2HR

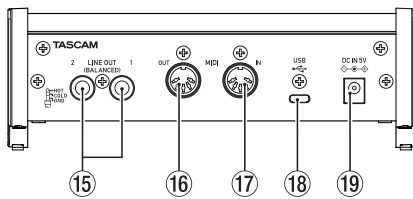

#### US-4x4HR

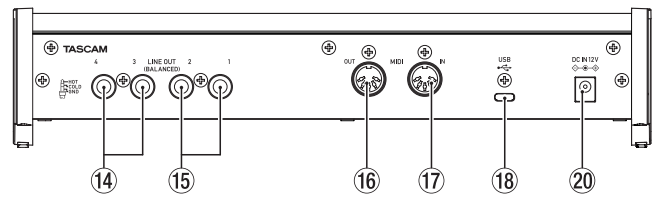

#### ⑭ LINE OUT (BALANCED) 3-4 jacks (US-4x4HR only)

These standard TRS jacks are analog line outputs.

- TRS (Tip: HOT, Ring: COLD, Sleeve: GND)

#### ⑮ LINE OUT (BALANCED) 1-2 jacks

These standard TRS jacks are analog line outputs.

- TRS (Tip: HOT, Ring: COLD, Sleeve: GND)

The signals output from the LINE OUT (BALANCED) 1-2 jacks (1-4 jacks on US-4x4HR) can be set in the Settings Panel. (see "Settings Panel overview" on page 14)

#### ⑯ MIDI OUT connector

This 5-pin DIN is a standard MIDI output connector.

This outputs MIDI signals.

#### ⑰ MIDI IN connector

This 5-pin DIN is a standard MIDI input connector.

Use this to input MIDI signals.

#### ⑱ USB port

This is a USB Type-C port.

Use a USB cable to connect the unit to a computer or an iOS device.

#### ATTENTION

- When using this unit while connected to a computer, it will receive power from the computer's USB port. Depending on the computer, the USB port might not be able to supply enough power to operate the unit. In this case, connect and use a dedicated AC adapter.
- When connected to a USB 3.0 port, it will function in High Speed mode equivalent to USB 2.0 (480 Mbps maximum).
- After waking a computer from suspend (sleep) mode, if the unit does not operate properly, turn it off and turn it on again or disconnect and reconnect the USB cable.

#### ⑲ DC IN 5V connector (US-2x2HR only)

When connected to an iOS device or other equipment that cannot power this unit, a dedicated AC adapter (PS-P520E, DC5V, sold separately) with power supply must be connected to the DC IN 5V connector. (see "When using an iOS device" on page 10)

#### NOTE

When using a US-2x2HR that is connected to a computer using the included USB cable, it will receive power from the computer's USB port, so a dedicated AC adapter (PS-P520E, DC5V, sold separately) should not be necessary.

Depending on the computer, however, the USB port might not be able to supply enough power to operate the unit.

In this case, use a dedicated AC adapter (sold separately).

#### ⑳ DC IN 12V connector (US-4x4HR only)

Under the following conditions, connect the included DC12V AC adapter (PS-P1220E, DC12V) here. (see "Using with an AC adapter" on page 10)

- When the USB bus power supply current is insufficient
- When connected to an iOS device or other equipment that cannot power this unit

# 3 – Installation

---

## System requirements

---

Check the TEAC Global Site (<https://teac-global.com/>) for the latest information about supported operating systems.

---

### Windows

#### Supported operating systems

Windows 10 32-bit  
Windows 10 64-bit  
Windows 8.1 32-bit  
Windows 8.1 64-bit  
Windows 7\*  
    Windows 7 32-bit SP1 or later  
    Windows 7 64-bit SP1 or later

\* Operation has been confirmed with the final version of Windows 7.

#### Computer hardware requirements

Windows computer with a USB 2.0 (or higher) port

#### CPU/processor speed

2 GHz or faster dual core processor (x86)

#### Memory

2 GB or more

#### ATTENTION

Operation of this unit was confirmed using standard computers that meet the above requirements. This does not guarantee operation with all computers that meet the above requirements.

Even computers that meet the same system requirements might have processing capabilities that differ according to their settings and other operating conditions.

#### NOTE

Since noise could occur depending on the computer system used, we recommend selecting “*High performance*” for “*Plugged in*” on the Power Options Control Panel page.

---

## Mac

#### Supported operating systems

macOS Catalina (10.15 or later)  
macOS Mojave (10.14 or later)  
macOS High Sierra (10.13 or later)

#### Computer hardware requirements

Mac with a USB 2.0 (or higher) port

#### CPU/processor speed

2 GHz or faster dual core processor

#### Memory

2 GB or more

---

## Apple iOS devices

#### Supported operating systems

iPadOS13  
iOS13  
iOS12  
iOS11

---

## Supported audio drivers

#### Windows

ASIO2.0, WDM, MIDI

#### Mac

Core Audio, Core MIDI

#### iOS device

Core Audio

## Installing the dedicated software

To use this unit, a dedicated software must be installed on a computer.

The dedicated software might be updated at any time.

Download the latest software for the operating system you are using from the TEAC Global Site (<https://teac-global.com/>).

- When you install the dedicated software on a Windows computer, the Windows driver and the Settings Panel application will be installed.
- When you install the dedicated software on a Mac, only the Mac Settings Panel application will be installed. The standard OS driver will be used.
- With an iOS device, the standard OS driver will be used, so there is no need to install any.

### ATTENTION

Before starting to install software, quit other applications.

## Installing the Windows dedicated software

### ATTENTION

- Complete installation of the Windows dedicated software on the computer before connecting the unit to it with the USB cable.
- If you connected the unit to the computer using the USB cable before installing the Windows dedicated software and the *“Found New Hardware Wizard”* launched, close the Wizard and disconnect the USB cable.

## Windows dedicated software installation procedures

1. Download the latest Windows dedicated software from the TEAC Global Site (<https://teac-global.com/>) and save it on the computer to be used with the unit.
2. Uncompress the saved software (zip file) on the computer desktop or another location.
3. Double-click the *“TASCAM\_US-HR\_Installer\_x.xx.exe”* file in the folder that appears after uncompression to automatically launch the installation software.

### ATTENTION

If you open a zip file without decompressing it and doubleclick the *“TASCAM\_US-HR\_Installer\_x.xx.exe”* file in the folder that opens, installation will not start. Right-click the zip file and select *“Extract All”*, for example, to decompress it and then try again.

4. When a *“Security Warning”* or *“User Account Control”* screen appears, click the *“Yes”* button.

5. Read the contents of the License Agreement, and select *“I accept the agreement”* if you agree to the terms. Then, click the *“Next”* button.

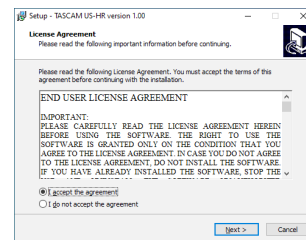

6. Next, click the *“Install”* button.

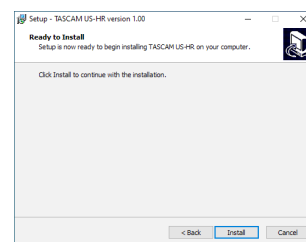

7. Next, click the *“Install”* button to start installation (Windows 8.1/Windows 7).

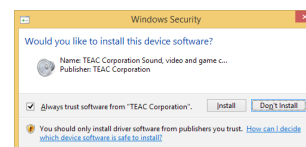

8. The following screen appears when installation has completed. Click the *“Finish”* button.

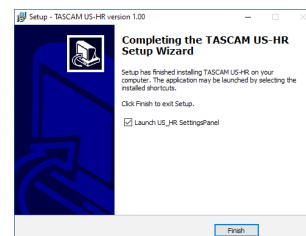

The installer will quit and the Windows Settings Panel will launch.

### NOTE

The first time you connect the unit by USB to the computer after installing the software, installation of the device driver will be executed. Some time might be necessary before the unit is recognized because Windows Update will be automatically searched at this time.

If the unit is still not recognized after a while, open the software installation screen from the notification area at the bottom right of the computer display, and click *“Skip obtaining driver software from Windows Update”* to stop the search.

# 3 – Installation

## Installing the Mac dedicated software

### NOTE

- Install the Mac dedicated software on the computer before connecting the unit to it with the USB cable.
- Depending on the Gatekeeper setting, a warning message might appear during installation. Please see “Working with Gatekeeper” on page 8 for information about Gatekeeper.

## Mac dedicated software installation procedures

1. Download the latest Mac dedicated software for the operating system you are using from the TEAC Global Site (<https://teac-global.com/>) and save it on the computer to be used with the unit.
2. Double-click “US-HR\_Installer\_x.xx.dmg”, which is the saved disk image file for the Mac dedicated software, and double-click “US-HR\_Installer.pkg” inside the folder that opens.

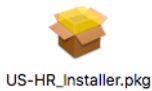

US-HR\_Installer.pkg

### NOTE

Depending on the computer’s settings, the downloaded zip file might not have been uncompressed automatically. In this case, uncompress the zip file first and then double-click the disk image file.

3. When the installer starts, click the “Continue” button.

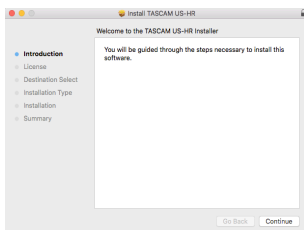

4. Next, select the desired language and click the “Continue” button.

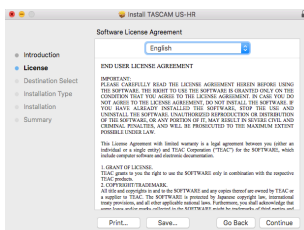

5. Click the “Read License” button and check the contents of the Software License Agreement. If you agree to the contents of the license, click “Agree”. Then, click the “Next” button.

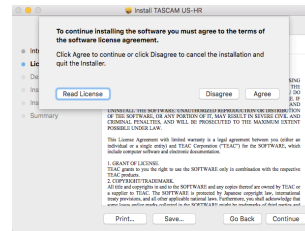

6. Next, click the “Install” button to start installation.

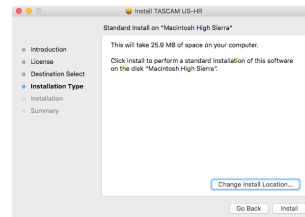

7. The following screen appears when installation has completed. Click the “Close” button.

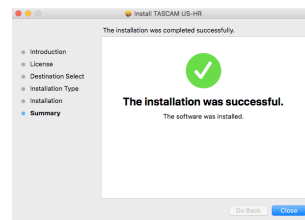

## Working with Gatekeeper

When using macOS, depending on the Gatekeeper security function setting, a warning message might appear during installation.

The solution depends on the warning message shown. See the following explanations for details.

## When the Gatekeeper setting is “Allow applications downloaded from: the Mac App Store”

The following security warning might be shown:

“US-HR\_Installer.pkg” can’t be opened because it was not downloaded from the Mac App Store.”

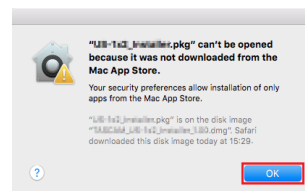

In this case, click the “OK” button to close the message. Then, control-click (or right-click) the file and click “Open” in the menu.



When the *“US-HR\_Installer.pkg” can’t be opened because it was not downloaded from the Mac App Store. Are you sure you want to open it?* security warning message appears, click the *“Open”* button.

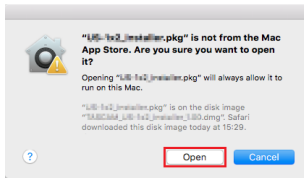

This warning message might also appear when the Gatekeeper setting is something other than *“Allow applications downloaded from: the Mac App Store”*. The file still might not open and *“US-HR\_Installer.pkg” can’t be opened because it was not downloaded from the Mac App Store.* might appear again.

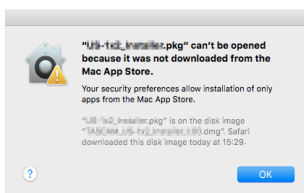

In this case, copy the file from the folder where it is to the desktop or another folder, and then open it. Alternatively, change the Gatekeeper settings to *“Allow apps downloaded from: App Store and identified developers”* and try opening it again.

## When the Gatekeeper setting is *“Allow applications downloaded from: the Mac App Store”*

*“US-HR\_Installer.pkg” is an application downloaded from the Internet. Are you sure you want to open it?* might appear as a security warning message. In this case, click the *“Open”* button.

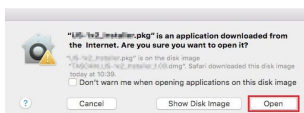

## Changing the Gatekeeper setting

The Gatekeeper setting can be changed using the *“Allow applications downloaded from:”* item on the *“General”* page of the *“Security & Privacy”* pane of the System Preferences. To change this, you must click the lock icon (🔒) at the bottom left and enter a password to unlock the settings.

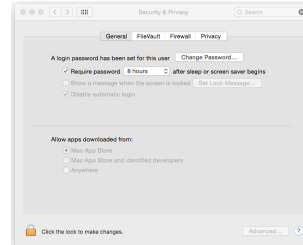

This setting will lock again when you close the System Preferences by clicking the 🔒 button or typing command-Q, for example, or when you click *“Show All”* to close the open pane.

### ATTENTION

Changing the Gatekeeper settings could result in security risks.

If you changed the Gatekeeper setting to decrease security (use one of the lower settings), set it back to the original setting after updating the software and/or firmware. (When installing a firmware update immediately after software, do this after installing the firmware update.)

## Uninstalling the dedicated software

### NOTE

Normally, there is no need to uninstall the dedicated software.

Follow these procedures if a problem occurs or you no longer intend to use the unit with the computer.

## Uninstalling the Windows dedicated software

1. Open the *“Uninstall or change a program”* screen using the procedures for the operating system being used (Windows 10/Windows 8.1/Windows 7).
2. Select *“TASCAM US-HR version x.xx”* from the list, and double-click it.
3. Then, follow the instructions that appear on the screen.

## Uninstalling the Mac dedicated software

Delete *“US-HR\_Settings Panel”* from the Application folder to complete uninstallation.

# 4 – Preparation

## Connecting the power

### When using a computer (Windows/Mac)

When this unit is connected to a computer using an included USB cable, it will operate using USB bus power, so connecting a separate power supply device is not necessary.

#### ATTENTION

When operating the US-4x4HR with USB bus power, use a commercially-available Type-C–Type-C cable to connect it to a USB Type-C port on the computer. If there is a problem with the power supply, the phantom power indicator will blink. In this case, use the included AC adapter (PS-P1220E, DC12 V).

#### NOTE

Depending on the computer, the USB port might not be able to supply enough power to operate the unit. In this case, connect and use a dedicated AC adapter.

### When using an iOS device

When this unit is connected to an iOS device, connecting a dedicated AC adapter is necessary to supply power to the unit. Connect the dedicated AC adapter before connecting the USB cable.

### Using with an AC adapter

#### US-2x2HR

Connect an AC adapter (PS-P520E, DC5V, sold separately) to the DC IN 5V connector.

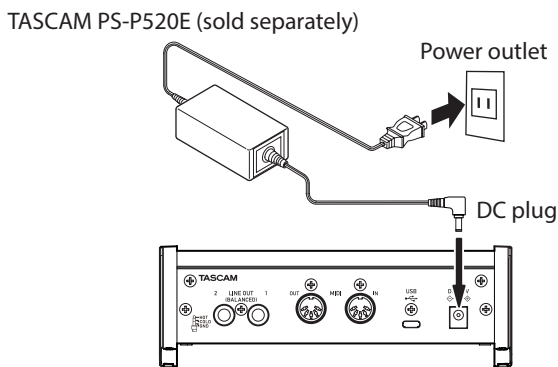

#### ATTENTION

We highly recommend using a dedicated AC adapter (PS-P520E, DC5 V, sold separately) with the US-2x2HR. When using another external power supply device, use one with the following specifications.

- Power supply voltage: 5 V
- Power supply current: 700 mA or more

Using a power supply device with specifications other than the above could cause malfunction, overheating, fire or other problems. If trouble should occur, stop using the unit and contact the retailer where you purchased it or a TEAC service center to request repair.

#### US-4x4HR

Under the following conditions, connect the included DC12V AC adapter (PS-P1220E, DC12 V) to the DC IN 12V connector.

- When the USB bus power supply current is insufficient
- When connected to an iOS device or other equipment that cannot power this unit

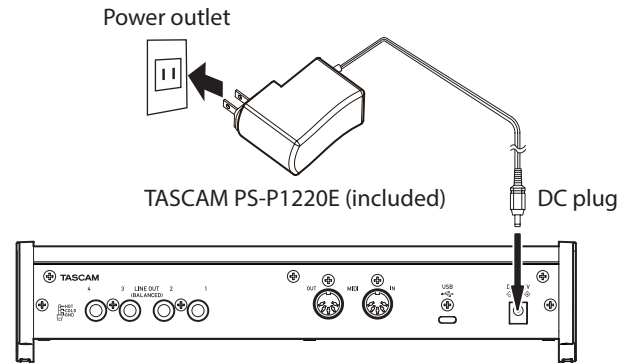

#### ATTENTION

Always use the dedicated AC adapter (PS-P1220E, DC12 V) that was shipped with the unit. Using a different AC adapter could cause malfunction, overheating, fire or other problems.

#### NOTE

The included dedicated AC adapter (PS-P1220E, DC12 V) is shipped with 4 types of outlet plugs. Attach the type of plug that matches the power outlet that you are using. (see "Changing the outlet plug (US-4x4HR only)" on page 11)

## Changing the outlet plug (US-4x4HR only)

### NOTE

When the US-4x4HR is purchased new, the included AC adapter (PS-P1220E, DC12V) has an outlet plug (A) already attached. There should be no need to change the plug.

1. Move the knob (1) on the PS-P1220E AC adapter in the direction of the arrow and remove the plug (A).

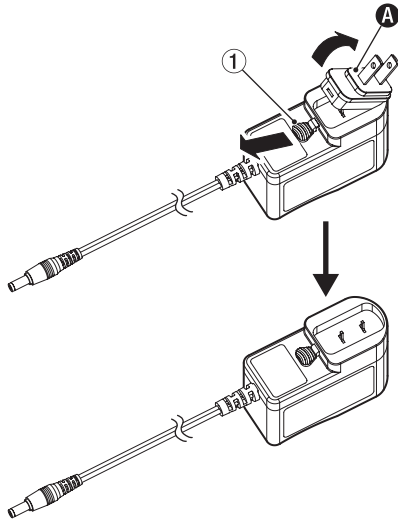

2. Move the knob (1) in the direction of the arrow again, and attach the included outlet plug (B) to the AC adapter.

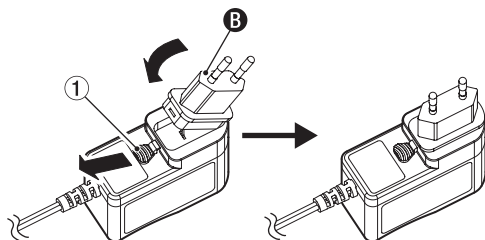

This completes changing the outlet plug.

After changing the outlet plug, confirm that it is not loose or crooked and that everything is normal before plugging it into an outlet.

### ATTENTION

Do not use the adapter if there is anything abnormal about the plug after changing it. Use when the plug is abnormal could cause fire or electric shock. Contact the retailer where you purchased the unit or a TEAC service center (on the back cover) to request repair.

## Connecting other equipment

This is an example of US-4x4HR connections.

### Precautions before making connections

- Carefully read the operation manuals of the devices to be connected and then connect them correctly.
- Before making connections, turn this unit and all equipment to be connected off (standby).
- Install all connected devices, including this unit, so that they are powered from the same line. When using a power strip or similar device, be sure to use one that has high current capacity (thick cable) in order to minimize fluctuations in power voltage.

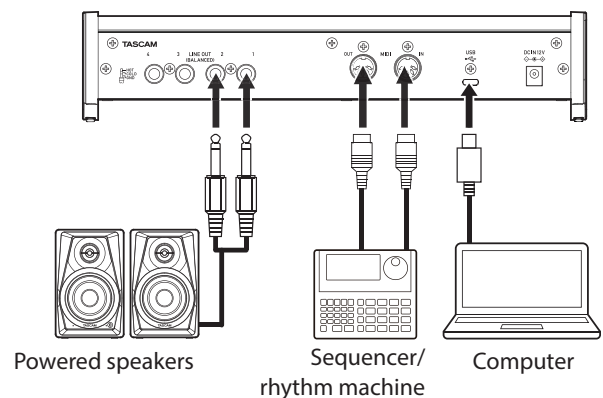
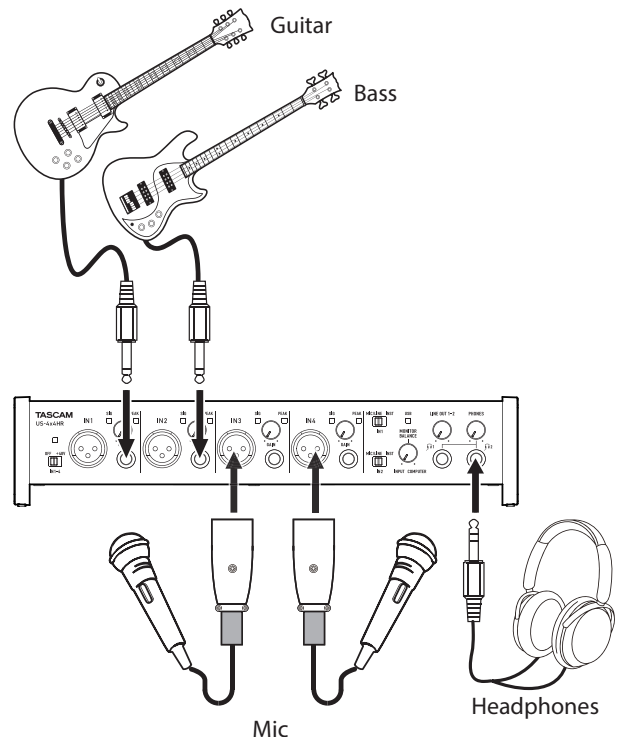

Examples of connections to a US-4x4HR

## 4 – Preparation

### Connecting with a computer

Use the included USB cable to connect the unit to a computer USB port compatible with 2.0, 3.0 or higher USB specifications. When the USB connection is working, the USB indicator on the front of the unit lights.

#### ATTENTION

- When operating the US-4x4HR with USB bus power, use a commercially-available Type-C–Type-C cable to connect it to a USB Type-C port on the computer. If there is a problem with the power supply, the phantom power indicator will blink. In this case, use the included AC adapter (PS-P1220E, DC12 V). (see “Using with an AC adapter” on page 10)
- If you connect this unit to a computer via a USB hub, for example, bus power could be insufficient, and audio signal dropouts, clicking noises and other interference could occur due to the influence of other USB devices connected to that hub. For this reason, we strongly recommend connecting this unit to a separate USB port. Connecting USB keyboards and mice, however, to the same bus should not be a problem.

### Connecting with iOS devices

To connect with an iOS device that has a Lightning connector use a Lightning to USB Camera Adapter\* and the USB cable included with this product.

To connect with an iOS device that has a USB Type-C connector, use a commercially-available Type-C–Type-C cable.

\* You must obtain a genuine Apple Lightning to USB Camera Adapter separately.

#### NOTE

When connected, this unit will not provide power to the iOS device.

### Audio connections

Analog audio signals input into this device from mics, guitars, keyboards and other audio equipment can be converted into digital signals and transmitted to the computer via USB. In addition, by connecting speakers (through an amplifier if not powered) or headphones to this unit, you can monitor audio signals that are input to this unit and output from the computer.

#### CAUTION

Before connecting audio equipment, set the GAIN, LINE OUT and PHONES knobs to their lowest values. Failure to do so could cause sudden loud noises from monitoring equipment, and this could damage the equipment or harm hearing.

### Connecting microphones

#### Dynamic mics

Connect these to the IN1/IN2 (and IN3/IN4 on US-4x4HR) input jacks on the front of the unit.

#### Condenser mics

When using condenser mics that require phantom power, connect them to the IN1/IN2 (and IN3/IN4 on US-4x4HR) jacks, and set the phantom power switch to +48V.

When the phantom power switch is set to +48V, the phantom power indicator on the front of the unit lights.

#### CAUTION

Lower the LINE OUT and PHONES knobs before changing the phantom power switch between +48V and OFF. Depending on the connected mics, sudden loud noises from monitoring equipment could occur, and this could damage the equipment or harm hearing.

#### ATTENTION

- Before connecting condenser mics, turn this unit and all equipment to be connected off (standby).
- The phantom power switch changes the setting for all input channels simultaneously (2 inputs on US-2x2HR and 4 inputs on US-4x4HR). Do not set the phantom power switch to +48V when connecting a mic that does not require phantom power.
- Do not connect or disconnect mics while the phantom power switch is set to +48V. Doing so could cause a loud noise and might damage this unit and connected equipment.
- Set the phantom power switch to +48V only when using a condenser microphone that requires phantom power. Setting phantom power to +48V when a dynamic mic or other equipment that does not require it is connected could damage this unit and the connected equipment.
- When using condenser mics that require phantom power and dynamic mics together, be sure to use balanced dynamic mics. Unbalanced dynamic mics cannot be used when phantom power is enabled.
- Supplying phantom power to some ribbon mics could break them. If you are unsure, do not supply phantom power to a ribbon mic.
- If you connect this unit to a laptop computer that is running on battery power and set the phantom power switch to +48V, the computer battery charge will be consumed more quickly.

### Connecting guitars

When connecting a guitar or bass directly to this unit, use the IN1 or IN2 jack on the front of the unit and set the MIC/LINE INST switch for that jack to INST.

### Connecting electronic instruments and other audio equipment

When connecting an electronic instrument or other audio equipment directly to this unit, use the IN1 and IN2 jacks on the front of the unit and set their MIC/LINE INST switches to MIC/LINE.

## Connecting analog record players

The output of an analog record player cannot be connected directly to this unit. To connect an analog record player to this unit, a phono amp and equalizer (or an audio amplifier that has phono input jacks) must be connected between them.

## Connecting monitor speakers

Connect monitor speakers (powered speakers or an amplifier and speaker system) to the LINE OUT (BALANCED) 1-2 jacks on the back of the unit.

Use the LINE OUT knob on the front of the unit to adjust the speaker volume.



## Connecting headphones

Connect headphones to the PHONES jack (standard stereo) on the front of the unit.

### CAUTION

Before connecting headphones, minimize the volume with the PHONES knob. Failure to do so could result in a sudden loud noise that could harm hearing, for example.

### NOTE

The same signals are output from both the  1 and  2 jacks of the US-4x4HR.

## MIDI connections

Connect sound modules, keyboards, synthesizers, drum machines and other MIDI devices to the unit in the following manner.

- If you want to monitor sound from a MIDI device, connect its audio outputs to the IN1/IN2 (or IN3/IN4 on US-4x4HR) jacks on the front of the unit or use an external mixer.
- You can also use the MIDI IN and OUT connectors on the back of the unit to send and receive MIDI timecode (MTC). By doing this, you can use an application that supports MTC to synchronize a multitrack recorder (MTR) and MIDI devices.

### ATTENTION

- The USB indicator might stay lit even after the connected computer is shut down. This is because some computers continue to provide power through USB cables even after being shut down.
- When using an audio application, if the “MIDI music playback (default device)” is set to “Microsoft GS Wavetable SW Synth” in the Sound and Audio Devices Properties Control Panel, MIDI performances can be heard through this unit’s LINE OUT (BALANCED) 1-2 (and 3-4 on US-4x4HR) as well as PHONES jacks.

## Using direct monitoring

When the Settings Panel *LINE OUT 1-2* or *LINE OUT 3-4* setting is Monitor Mix, the MONITOR BALANCE knob and input monitoring without delay (direct monitoring) are enabled.

Use the MONITOR BALANCE knob to adjust the monitoring balance between the signals from this unit’s input jacks and the output signals from the computer.

### NOTE

- This setting adjusts the monitoring balance. It does not affect recording levels.
- When using this function, confirm that the input is not set as an output (monitoring on, for example) in the DAW or other recording software. Input signals could be added to computer output signals, resulting in the doubling of sounds.

# 5 – Using the Settings Panel

## Opening the Settings Panel

You can use the Settings Panel to make settings for the various functions of the unit.

Open the Settings Panel in the following manner.

### NOTE

- The unit will operate using the setting values set in the Windows or Mac Settings Panel.
- The Settings Panel cannot be used with an iPad or other iOS device.

## Windows

- From the “Start” menu select “US\_HR Settings Panel” under “TASCAM”.

## Mac

- On the Launchpad, click “US-HR\_SettingsPanel”.
- Using the Finder, open the Applications folder and click “US-HR\_SettingsPanel” to open the Settings Panel.

## Settings Panel overview



Windows Settings Panel



Mac Settings Panel

### ① IN 1-2/IN 3-4 buttons

Set the monitoring signal for the IN1/IN2 (or US-4x4HR IN3/IN4) jacks to Mono or Stereo.

The selected **Mono** or **Stereo** button appears lit.

| Button        | Meaning  |
|---------------|--|
| <b>Mono</b>   | The signals output from the channels set for the Monitor Mix will be mono.<br>Signals sent from the computer depend on the Loopback setting.   |
| <b>Stereo</b> | The signals output from the channels set for the Monitor Mix will be stereo.<br>Signals sent from the computer depend on the Loopback setting. |

### ② Audio Input ON switches

Turn input on/off for each channel separately.

When on, the  switches will appear lit and signals will be input on those channels.

### ③ LINE OUT 1-2

Select the signals output from the unit's LINE OUT (BALANCED) 1-2 jacks and PHONES (1 and 2 on US-4x4HR) jacks.

| Options                                    | Meaning   |
|--|---|
| <b>Monitor Mix</b>                         | The signals from the channels selected using the Audio Input ON switches and the signals sent from the computer by USB are mixed using the MONITOR BALANCE knob and output. |
| <b>Computer Out 1-2</b>                    | Only the <b>Computer Out 1-2</b> signals sent from the computer by USB are output.  |
| <b>Computer Out 3-4</b><br>(US-4x4HR only) | Only the <b>Computer Out 3-4</b> signals sent from the computer by USB are output.  |

### NOTE

- Selecting **Monitor mix** enables the MONITOR BALANCE knob on the front of the unit and input monitoring without delay (direct monitoring). (see “Using direct monitoring” on page 13)
- Set the MONITOR BALANCE knob all the way to the left (INPUT) to monitor only the input channel signals and set it all the way to the right (COMPUTER) to monitor only signals output from the computer. At other positions, both signals will be mixed.

# 5 – Using the Settings Panel

## ④ LINE OUT 3-4 (US-4x4HR only)

Select the signals output from the unit's LINE OUT (BALANCED) 3-4 jacks.

| Options                                 | Meaning   |
|---|---|
| <i>Monitor Mix</i>                      | The signals from the channels selected using the Audio Input ON switches and the signals sent from the computer by USB are mixed using the MONITOR BALANCE knob and output. |
| <i>Computer Out 1-2</i>                 | Only the <i>Computer Out 1-2</i> signals sent from the computer by USB are output.  |
| <i>Computer Out 3-4 (US-4x4HR only)</i> | Only the <i>Computer Out 3-4</i> signals sent from the computer by USB are output.  |

### NOTE

- Selecting *Monitor mix* enables the MONITOR BALANCE knob on the front of the unit and input monitoring without delay (direct monitoring). (see "Using direct monitoring" on page 13)
- Set the MONITOR BALANCE knob all the way to the left (INPUT) to monitor only the input channel signals and set it all the way to the right (COMPUTER) to monitor only signals output from the computer. At other positions, both signals will be mixed.

## ⑤ Buffer Size (Windows only)

You can adjust the size of the buffer used to handle the audio input and output signals transferred to and from the computer.

Smaller buffer sizes result in less audio signal delay (latency), but require high-speed processing by the computer.

If the processing cannot keep up, for example, due to other system operations, clicking and popping noises might occur and the audio signal might even drop out.

Increasing the buffer size will stabilize operation and suppress negative effects on audio signals, but the delay in audio signals sent to the computer will increase.

You can adjust the buffer size used with this unit according to your use conditions.

Options

*4 Samples, 8 Samples, 16 Samples, 24 Samples, 32 Samples, 64 Samples, 128 Samples, 256 Samples (default), 512 Samples, 1024 Samples, 2048 Samples*

## ⑥ Information display area

This shows the current status of the unit.

| Item displayed     | Meaning   |
|--------------------|---|
| <i>Sample Rate</i> | This shows the sampling frequency.  |
| <i>Device</i>      | This is the name of the connected unit. ("No Device" is shown when no device is connected.) |

## ⑦ Loopback

Use to turn the loopback function on or off. When off, the Input, Output and BROADCAST Volume settings are not applied.

Options: *OFF* (default), *ON*

### ATTENTION

If using an application in which only one channel is input even though Loopback is set to "*Stereo*" (stereo input is not supported), "*Mono*" Loopback must be used. In this case, set both Input and Output to "*Mono*".

## ⑧ Input

Use to set whether the input signal from the IN1/IN2 jack is converted to mono or kept as stereo when used as a loopback signal.

Options: *Mono, Stereo* (default)

## ⑨ Output

Use to set whether signals are converted to mono or kept as stereo when looping back USB output.

Options: *Mono, Stereo* (default)

## ⑩ BROADCAST Volume slider

Use to adjust the playback volume of Sound Recorder and karaoke apps. Use this also to adjust the transmitted volume with live broadcast apps.

### NOTE

When adjusting the BROADCAST Volume, turn the MONITOR BALANCE knob on the unit all the way to the right (COMPUTER).

## ⑪ Auto Power Save ON switch

Turn this on to enable the automatic power saving function. When this setting is on, if operating in standalone mode and no input signal (above -60 dBFS) has been detected for 30 minutes, the unit will turn itself off (start standby) automatically.

# 5 – Using the Settings Panel

## Notification function

If the computer you are using is connected to the Internet, notifications might appear when the Settings Panel is launched.

### NOTE

Put a check in the *“Do not show the same message again”* checkbox to prevent the same message from being shown the next time it is launched.

## Checking software and firmware versions

Select About from the Help menu to open the following screen. The software and firmware versions can be checked here.

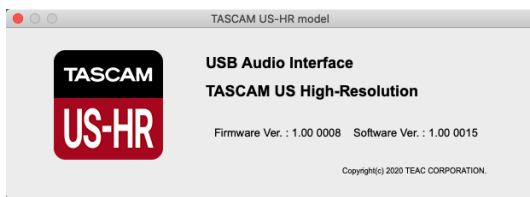

| Item displayed | Meaning  |
|----------------|--|
| Firmware Ver.  | This is the firmware version used by the connected unit. |
| Software Ver.  | This is the software version.                            |

## Automatic software and firmware update function

If the computer you are using is connected to the Internet, when a new version of the software or the firmware is released, a notification about automatic updating will appear when the software is launched.

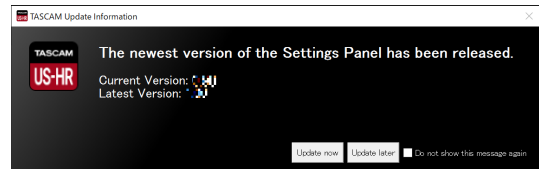

Software update notification

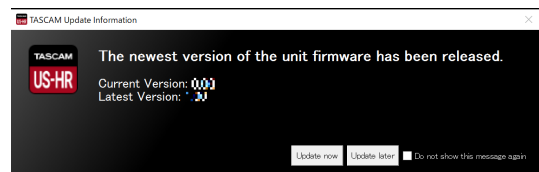

Firmware update notification

Click the *“Update now”* button to use the latest version of the software or firmware.

The file will be downloaded automatically in the update software will launch.

Click the *“Update later”* button to close the update window if you do not want to update or want to update later.

### NOTE

- Put a check in the *“Do not show the same message again”* checkbox to prevent the same message from being shown the next time it is launched.
- After closing the update window, you can reopen it by selecting *“Update”* from the *“Help”* menu.



# 6 – Application Guide

In this chapter, we explain how to set some audio applications for use with this unit.

---

## DAW software

---

### Bundled DAW software

Download quickstart guides for the bundled DAW software from the TEAC Global Site (<https://teac-global.com/>), and refer to them for instructions about downloading, installing and making settings in these applications.

---

### Other DAW software

When using any other DAW software, consult its operation manual.

When using a DAW that supports ASIO, select “US-HR Series ASIO”.

---

## Windows

---

1. Open the “**Sound**” screen using the procedures for the operating system being used (Windows 10/Windows 8.1/Windows 7).
2. On the “**Playback**” page, right-click “**US-2x2 HR**” or “**US-4x4 HR**”, and click “**Set as Default Device**” in the pop-up menu that appears.  
When you do this, the green check mark appears next to the selected device.

#### NOTE

To use the unit as a recording device, set the default device according to the device being used on the “**Recording**” tab in the same manner as on the “**Playback**” tab.

3. After completing the setting, click the “**OK**” button.
4. Start an audio application, select an audio file and begin playback.

#### NOTE

- If you change the setting while an audio application is running, the software will not recognize that the device has been changed. In this case, restart the application.
- If you still cannot hear sound after making the settings and completing the procedures above, restart the computer.
- If you make this setting, sound will be output through this unit, but no sound will be output from the computer’s speakers or headphone jack.

---

## macOS

---

1. Open the “**Utilities**” folder in the “**Applications**” folder, and double-click “**Audio MIDI Setup**”. Then open the “**Audio Devices**” window.
2. Click “**US-2x2 HR**” or “**US-4x4 HR**” to select it. Then, while right-clicking or control-clicking it, click “**Use this device for sound output**” in the pop-up menu that appears.  
The speaker mark moves next to “**US-2x2 HR**” or “**US-4x4 HR**”.

#### NOTE

To use this device as the recording device, set “**US-2x2 HR**” or “**US-4x4 HR**” to “**Use this device for sound input**”.

3. Launch an audio application, select an audio file and start playback.

#### NOTE

Do not change the sampling frequency when an audio application is playing back.

---

## iOS

---

When using this unit with an iOS device, no special settings are necessary. You can use the unit immediately after connecting it to the device by USB.

#### NOTE

Connecting headphones or other equipment to the headphone jack of the iOS device will interrupt USB communication with the unit.

# 7 – Standalone Mode

---

## Overview

---

- This unit will operate in standalone mode if it is turned on when it is not connected to a computer by USB.
- You can use this unit as a mic preamp and to monitor input signals. This function is convenient when you want to practice an instrument without recording, for example.
- An external power supply device is necessary. See “Connecting the power” on page 10 for details.

---

## Settings in standalone mode

---

When operating in standalone mode, input signals pass-through the built-in digital mixer and output selector, which are set at fixed values, and are output from the output jacks. In addition, when operating in standalone mode, the USB indicator will blink.

---

## Settings Panel settings

The current (most recently made) settings are retained for the following items on the Settings Panel.

- Direct Monitor Settings IN 1-2
- Direct Monitor Settings IN 3-4 (US-4x4HR only)
- Auto Power Save

*LINE OUT 1-2* and *LINE OUT 3-4* (US-4x4HR only) settings are fixed to “*Monitor Mix*”.

# 8 – MIDI Implementation Chart

## MIDI Implementation Chart

| Function         |               | Transmit | Recognize | Remarks |
|------------------|---------------|----------|-----------|---------|
| Basic channels   | When power on | ×        | ×         | Thru    |
|                  | Settable      | ×        | ×         |         |
| Mode             | When power on | ×        | ×         | Thru    |
|                  | Messages      | ×        | ×         |         |
|                  | Altered       | .....    |           |         |
| Note number      | Range         | ×        | ×         | Thru    |
| Velocity         | Note on       | ×        | ×         | Thru    |
|                  | Note off      | ×        | ×         |         |
| Aftertouch       | Polyphonic    | ×        | ×         | Thru    |
|                  | Channel       | ×        | ×         |         |
| Pitch bend       |               | ×        | ×         | Thru    |
| Control change   |               | ×        | ×         | Thru    |
| Program change   |               | ×        | ×         | Thru    |
|                  | Setting range | .....    |           |         |
| System exclusive |               | ×        | ×         | Thru    |
| System common    | Position      | ×        | ×         | Thru    |
|                  | Song select   | ×        | ×         |         |
|                  | Tune          | ×        | ×         |         |
| System real-time | Clock         | ×        | ×         | Thru    |
|                  | Command       | ×        | ×         |         |
| Other            | Local on/off  | ×        | ×         | Thru    |
|                  | All notes off | ×        | ×         |         |
|                  | Active sense  | ×        | ×         |         |
|                  | Reset         | ×        | ×         |         |
| Notes            |               |          |           |         |

Mode 1: OMNI ON, POLY  
Mode 3: OMNI OFF, POLY

Mode 2: OMNI ON, MONO  
Mode 4: OMNI OFF, MONO

○: YES  
×: NO

# 9 – Troubleshooting

Please read this chapter if you are unable to use the unit properly even after setting it following the procedures in this manual.

If you are still unable to resolve your problems please contact TASCAM customer support with the following information about the operating environment and details about the trouble.

## Operating environment

- Computer manufacturer:
- Model:
- CPU:
- Memory (RAM):
- Operating system:
- Applications used:
- Antivirus software:
- Wireless LAN use:

If these measures do not resolve the issue, please contact the retailer where you purchased this unit or a TEAC service center. See the end of this document for contact information.

## The dedicated software cannot be installed

1. Check the operating system  
The operating system being used might not be compatible with the software that you are trying to install. Check the compatible operating system of the software you are trying to install again.
2. Stop software running in the background  
Antivirus software and other software that runs in the background can prevent installation. Quit software that runs in the background and try installation again.

## The unit is connected, but the computer does not recognize it

1. Install the dedicated software
  - If you have not done so, install the dedicated software. See “Installing the dedicated software” on page 7 for details.
2. Change the USB port
  - This unit cannot be used with USB 1.1. Use a port that supports at least USB 2.0 or USB 3.0.
  - Do not use a USB hub with this unit. Always connect the unit directly to a USB port on the computer.
  - If the above methods do not resolve the problem, connect the unit to a different USB port on the computer.

## There is no sound even when playing back on the computer

Confirm that the MONITOR BALANCE knob on the unit is not turned all the way to the left (toward INPUT). If that is the case, turn the MONITOR BALANCE knob to the right of center (toward COMPUTER).

In addition, check the status of the unit’s connection with the computer.

Moreover, if you make the following settings, sound will be output through this unit, but no sound will be output by the computer’s speakers or headphone jack.

### Windows

See the “Windows” section of “6 – Application Guide” on page 17 in this manual, and make settings as necessary for the OS.

### Mac

1. Quit all applications and open “*System Preferences...*” from the Apple menu.
2. Open “*Sound*”.
3. On the “*Output*” tab, select “*US-2x2 HR*” or “*US-4x4 HR*”.

After completing the setting, restart the computer and check the sound of playback.

Depending on the application that you are using, you might need to make additional device settings.

In particular, DAW software operate using audio engines with settings that are different from the OS settings, so confirm the DAW settings first after installing the driver and Settings Panel software for this unit.

Please see the manuals for the applications that you are using for detailed setting procedures.

## The input sound has too much latency when monitoring

Use the direct monitoring function. (see “Using direct monitoring” on page 13)

## The input sound can be heard doubled

Confirm that the input is not set as an output (monitoring on, for example) in the DAW or other recording software.

An input signal from an input jack could sound doubled because along with direct monitoring it is also being monitored as an output signal from the computer.

## Sound breaks up or there is noise

The processing load on the computer causes sound to break up and noise to occur.

Here are some methods to reduce the load on the computer.

1. A wireless LAN and software running in the background, including antivirus software, regularly put processing loads on the computer, which can cause sound to break up and other noise.  
Stop wireless LAN transmission, antivirus software and other software running in the background when using this unit.
2. Set the buffer size (latency) in the audio application that you are using or in this unit's Settings Panel to a larger value (Windows only).

### NOTE

Consult the maker of the audio application that you are using for methods to reduce its load on your computer.

3. Change the settings of your computer so that they are optimal for audio processing.

### Using Windows

- Performance Options
  - ① Open the Control Panel using the appropriate method for the OS you are using (Windows 10/Windows 8.1/Windows 7).
    - In Windows 10, open the "Control Panel". Then, click the "System" icon.
    - In Windows 8.1, right-click the ordinary Start screen (Metro user interface screen) and then click "All apps". Then, right-click "Computer" and select "Properties".
    - In Windows 7, right-click "Computer" from the Windows Start button, and select "Properties".
  - ② Click "Advanced system settings".
  - ③ Click "Settings" in the "Performance" section of the "Advanced" tab of the "System Properties" window.
  - ④ In the "Visual Effects" tab of the "Performance Options" window, select "Adjust for best performance".
- Power Options
  - ① Open the Control Panel using the appropriate method for the OS you are using (Windows 10/Windows 8.1/Windows 7).
  - ② Click "Hardware and Sound".
  - ③ Click "Power Options".
  - ④ Click on "Create a power plan" and select "High Performance".

### NOTE

If an item is not shown, select the "Show Additional Plans" downward triangular button. Alternatively, click "Create a power plan".

### Using Mac

- ① Open "System Preferences..." from the Apple menu, and select "Energy Saver".
- ② Set "Computer sleep" to "Never".
- ③ Set "Display sleep" to "Never".

### NOTE

Depending on the macOS version and Mac computer model, this setting might not be available.

4. Connect to a different USB port.

Since the unit might not properly function with some USB ports, try connecting it to a different USB port.

### NOTE

- Try again after disconnecting other USB devices (Keyboards and mice can be left connected).
- Do not use a USB hub. Always connect the unit directly to a USB port on the computer (built-in).

## I see that the US-2x2HR or US-4x4HR recommends that I change the Windows Power Management settings. How do I do this?

Windows allows the processor to throttle to half speed when the computer is idle. However, this can affect the performance of DAW recording software. TASCAM recommends that this function be disabled, especially when using a multi-channel interface such as the US-4x4HR.

To Change the Power Management settings in Windows:

1. Open the Control Panel using the appropriate method for the OS you are using (Windows 10/Windows 8.1/Windows 7).
2. Click "Hardware and Sound".
3. Click "Power Options".
4. Select "High Performance" from the "Power Options".

### NOTE

If an item is not shown, select the "Show Additional Plans" downward triangular button. Alternatively, click "Create a power plan".

## Support for bundled software, including DAW software

TASCAM does not provide end-user support for the bundled DAW Software.

Please check the Help menu of the installed software to find where this support is available.

# 10 – Specifications

---

## General

---

### Sampling frequencies

44.1, 48, 88.2, 96, 176.4, 192 kHz

### Quantization bit depth

24-bit

---

## Input/output ratings

---

### Analog inputs

#### Mic inputs (balanced)

US-2x2HR: IN1/IN2

US-4x4HR: IN1/IN2, IN3/IN4

Connectors: XLR-3-31 equivalent (1: GND, 2: HOT, 3: COLD)

Maximum input level: +9 dBu (2.183 Vrms)

Rated input level: -7 dBu (0.346 Vrms)

Gain range: 56 dB

Input impedance: 2.2 k $\Omega$

#### Instrument inputs (unbalanced)

US-2x2HR: IN1/IN2

US-4x4HR: IN1/IN2

(MIC/LINE INST switch set to INST)

Connectors: 6.3mm (1/4") standard TS jacks  
(Tip: HOT, Sleeve: GND)

Maximum input level: +10 dBV (3.162 Vrms)

Rated input level: -6 dBV (0.501 Vrms)

Gain range: 56 dB

Input impedance: 1 M $\Omega$  or more

#### Line inputs (balanced)

US-2x2HR: IN1/IN2

US-4x4HR: IN1/IN2, IN3/IN4

(MIC/LINE INST switch set to MIC/LINE)

Connectors: 6.3mm (1/4") standard TRS jack  
(Tip: HOT, Ring: COLD, Sleeve: GND)

Maximum input level: +20 dBu (7.746 Vrms)

Rated input level: +4 dBu (1.228 Vrms)

Gain range: 56 dB

Input impedance: 10 k $\Omega$

---

### Analog outputs

#### Line Outputs (balanced)

US-2x2HR: LINE OUT (BALANCED) 1-2

US-4x4HR: LINE OUT (BALANCED) 1-2  
LINE OUT (BALANCED) 3-4

Connectors: 6.3mm (1/4") standard TRS jacks  
(Tip: HOT, Ring: COLD, Sleeve: GND)

Maximum output level: +20 dBu (7.746 Vrms)

Rated output level: +4 dBu (1.228 Vrms)

Output impedance: 210  $\Omega$

### Headphone output (PHONES)

Connectors: 6.3mm (1/4") standard stereo jack

Maximum output

US-2x2HR: 18 mW + 18 mW or higher

US-4x4HR: 45 mW + 45 mW or higher

(THD+N 0.1% or less, into 32  $\Omega$  load)

---

### Control input/output ratings

#### MIDI IN connector

Connector: 5-pin DIN

Format: standard MIDI

#### MIDI OUT connector

Connector: 5-pin DIN

Format: standard MIDI

#### USB

Connector: 4-pin USB Type-C

Transfer rate: USB 2.0 High Speed (480 Mbps)

---

### Audio performance

---

#### Mic amp EIN (equivalent input noise)

-128 dBu or less

#### Frequency response

##### MIC/LINE IN

At 44.1/48 kHz, 20 Hz – 20 kHz: +0 dB/-0.4 dB (JEITA)

At 88.2/96 kHz, 20 Hz – 40 kHz: +0 dB/-0.4 dB (JEITA)

##### LINE OUT

At 44.1/48 kHz, 20 Hz – 20 kHz: +0.2 dB/-0.1 dB (JEITA)

At 88.2/96 kHz, 20 Hz – 40 kHz: +0.2 dB/-0.4 dB (JEITA)

#### S/N ratio

110 dB

(MIC IN, GAIN knob at minimum, 20 kHz SPCL LPF + A-Weight)

108 dB

(LINE IN, GAIN knob at minimum, 20 kHz SPCL LPF + A-Weight)

110dB

(LINE OUT, LINE OUT knob at maximum, 20 kHz SPCL LPF + A-Weight)

#### THD + N

0.0013%

(MIC IN, 1 kHz sine wave, -5 dBFS input, GAIN knob at minimum, 20 kHz SPCL LPF)

0.0011%

(LINE IN, 1 kHz sine wave, -5 dBFS input, GAIN knob at minimum, 20 kHz SPCL LPF)

0.0012%

(LINE OUT, 1 kHz sine wave, -4 dBFS input, LINE OUT knob at maximum, 20 kHz SPCL LPF)

#### Crosstalk

95 dB or more (MIC/LINE IN to LINE OUT, 1 kHz sine wave, GAIN knob at minimum)

---

## Computer system requirements

---

Check the TEAC Global Site (<https://teac-global.com/>) for the latest information about supported operating systems.

---

### Windows

#### Supported operating systems

Windows 10 32-bit  
Windows 10 64-bit  
Windows 8.1 32-bit  
Windows 8.1 64-bit  
Windows 7\*  
    Windows 7 32-bit SP1 or later  
    Windows 7 64-bit SP1 or later

\* Operation has been confirmed with the final version of Windows 7.

#### Computer hardware requirements

Windows computer with a USB 2.0 (or higher) port

#### CPU/processor speed

2 GHz or faster dual core processor (x86)

#### Memory

2 GB or more

#### ATTENTION

Operation of this unit was confirmed using standard computers that meet the above requirements. This does not guarantee operation with all computers that meet the above requirements. Even computers that meet the same system requirements might have processing capabilities that differ according to their settings and other operating conditions

---

### Mac

#### Supported operating systems

macOS Catalina (10.15 or later)  
macOS Mojave (10.14 or later)  
macOS High Sierra (10.13 or later)

#### Computer hardware requirements

Mac with a USB 2.0 (or higher) port

#### CPU/processor speed

2 GHz or faster dual core processor

#### Memory

2 GB or more

---

### iOS device

Operation has been confirmed with Apple devices running the following iOS versions.

iPadOS13  
iOS13  
iOS12  
iOS11

#### ATTENTION

To connect an iOS device that has a Lightning connector, a genuine Apple Lightning to USB Camera Adapter (sold separately) is necessary.

---

### Supported audio drivers

#### Windows

ASIO2.0, WDM, MIDI

#### Mac

Core Audio, Core MIDI

#### iOS device

Core Audio

---

### Other

---

#### Power

##### Used with a computer

USB bus power or connected to the dedicated AC adapter below

##### Used with an iOS device

Connected to the dedicated AC adapter below

US-2x2HR: Dedicated AC adapter (TASCAM PS-P520E, DC 5 V)

US-4x4HR: Dedicated AC adapter (TASCAM PS-P1220E, DC 12 V)

#### Power consumption

US-2x2HR: 1.75 W

US-4x4HR: 2.25 W

#### External dimensions

US-2x2HR: 186 × 65 × 160 mm

(W x H x D, including protrusions)

US-4x4HR: 296 × 65 × 160 mm

(W x H x D, including protrusions)

#### Weight

US-2x2HR: 1.1 kg

US-4x4HR: 1.6 kg

#### Operating temperature range

5–35 °C (41 - 95°F)

# 10 – Specifications

---

## Dimensional drawings

---

### US-2x2HR

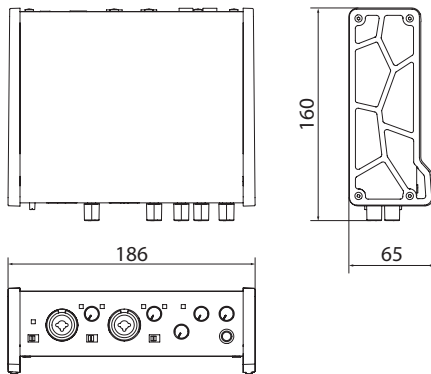

### US-4x4HR

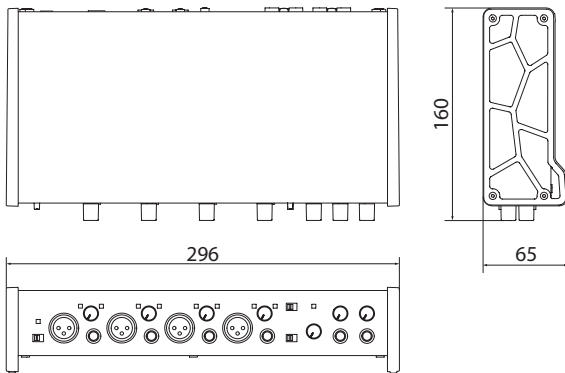

- Illustrations in this reference manual might differ in part from the actual product.
- Specifications and external appearance might be changed without notification to improve the product.



## Block diagram

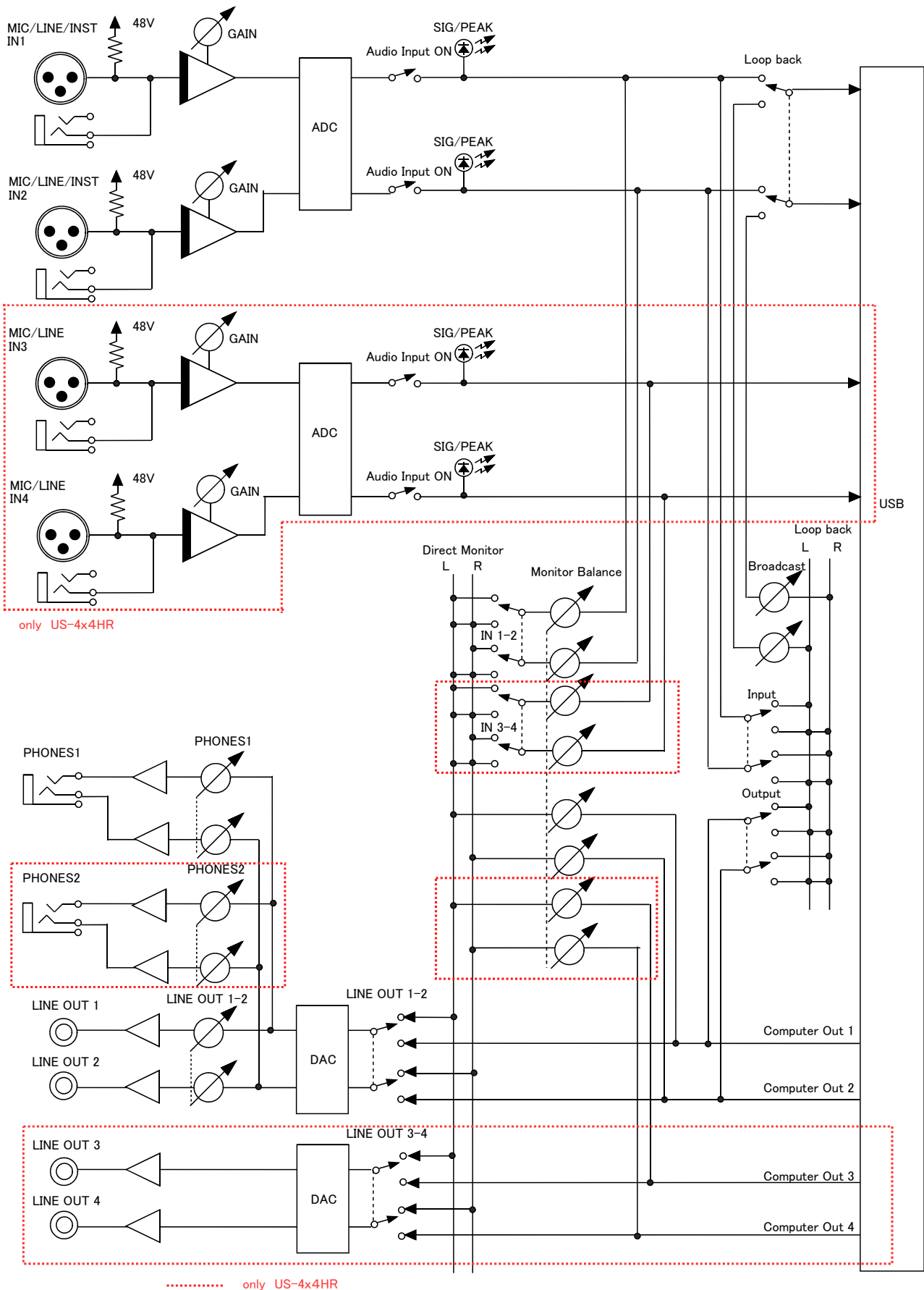

# TASCAM

TEAC CORPORATION

Phone: +81-42-356-9143

1-47 Ochiai, Tama-shi, Tokyo 206-8530 Japan

<https://tascam.jp/jp/>

---

TEAC AMERICA, INC.

Phone: +1-323-726-0303

10410 Pioneer Blvd. Suite #1 Santa Fe Springs, California 90670, U.S.A.

<https://tascam.com/us/>

---

TEAC UK Ltd.

Phone: +44-1923-797205

Meridien House, Ground Floor, 69 - 71, Clarendon Road, Watford, Hertfordshire, WD17 1DS, United Kingdom

<https://www.tascam.eu/en/>

---

TEAC EUROPE GmbH

Phone: +49-611-71580

Bahnstrasse 12, 65205 Wiesbaden-Erbenheim, Germany

<https://www.tascam.eu/de/>

---

TEAC SALES & TRADING(SHENZHEN) CO., LTD

Phone: +86-755-88311561~2

Room 817, Xinian Center A, Tairan Nine Road West, Shennan Road, Futian District, Shenzhen, Guangdong Province 518040, China

<https://tascam.cn/cn/>

---

1120. MA-3170A