

Noise Engineering

Loquelic Iteritas

Complex Digital Oscillator

Overview

Type	VCO
Size	10HP Eurorack
Depth	1 Inch
Power	2x8 Eurorack
+12 mA	150 / 80
-12 mA	5
+5 mA	0 / 90 (optional)

“I could kill someone with that”
-- DJ Surgeon

“This thing sounds fucking amazing
lots of stuff I’ve never heard before”
-- Surachai

Loquelic Iteritas is a digital VCO with interpretations of three classic synthesis algorithms involving dual pitch control. It creates a huge variety of sounds parameterized by four tone and two pitch controls.

Before Serial 555

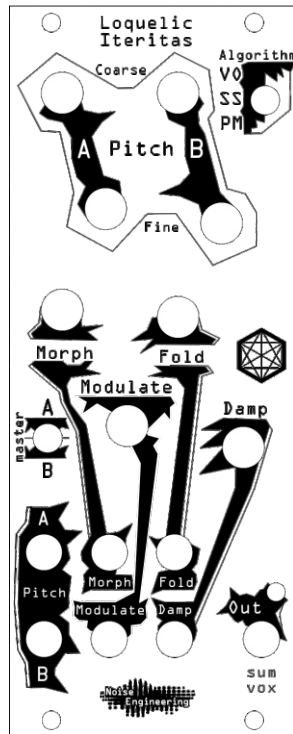

After Serial 555

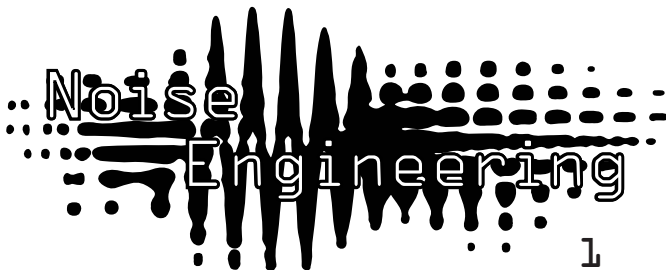
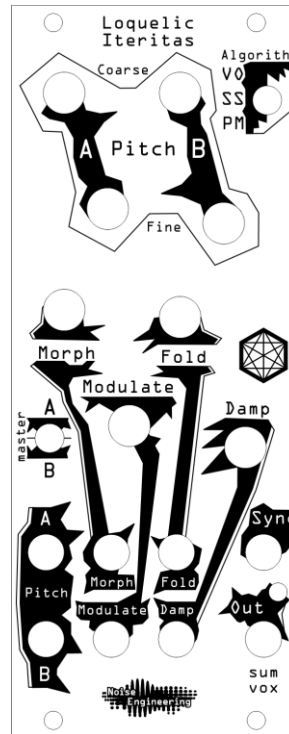

Noise Engineering

Loquelic Iteritas

Complex Digital Oscillator

Patch Tutorial

The easiest way to get to know Loquelic Iteritas is to turn the knobs and listen. Connect the output to your mixer and start twiddling.

Loquelic Iteritas is about continuous tone control. Hook any LFO up to any of the four tone control inputs (Morph, Fold, Modulate, Damp).

Other interesting effects can be created by controlling the pitches independently (by default the 1v/8va inputs are normaled to each other). For instance, using a Tonnetz Sequent to produce musical intervals produces interesting results.

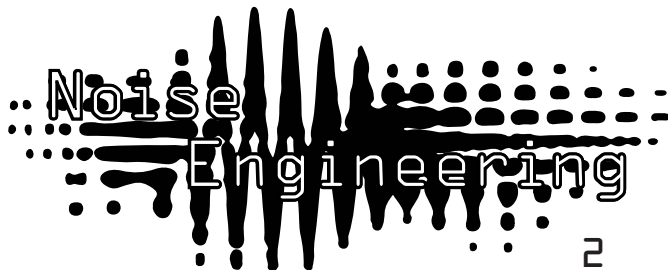
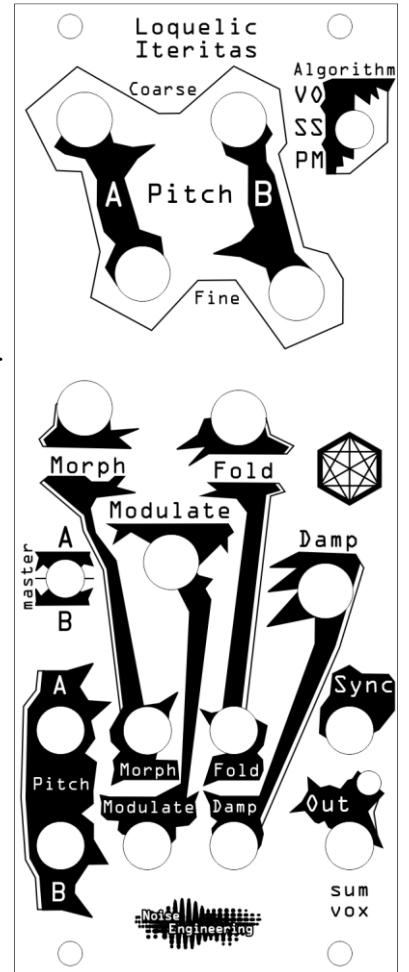

Noise Engineering

Loquelic Iteritas

Complex Digital Oscillator

Interface

Pitch A

The pitch of oscillator A can be controlled by the 1v/8va input and offset by its coarse and fine knobs. The pitch inputs are cross normalized.

Pitch B

The pitch of oscillator B can be controlled by the 1v/8va input and offset by its coarse and fine knobs. The pitch inputs are cross normalized.

Damp

is a tone control. Consult the following pages detailing each mode to find the behavior of this knob in the specific mode.

Mod

is a tone control. In all modes it controls phase modulation between the two pitch oscillators.

Fold

is a tone control. In all modes it controls the threshold of the wavefolding.

Morph

is a tone control. In all modes it controls the waveform of the oscillator continually varying between sin, triangle and saw.

Algorithm

selects which algorithm is used. These are detailed on the following pages.

Master

controls the sync of the oscillators. When in the middle position both oscillators are free running. When A is selected oscillator B will sync to oscillator A. when B is selected A will sync to B.

Sync

Sync will reset the state of the oscillators on a rising edge. Used for sync modulation. This jack was added starting at serial 700.

Out

Out is the AC coupled audio output.

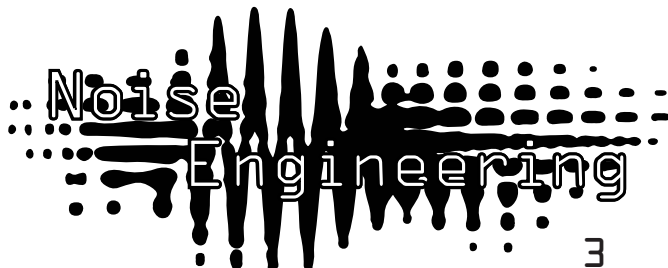
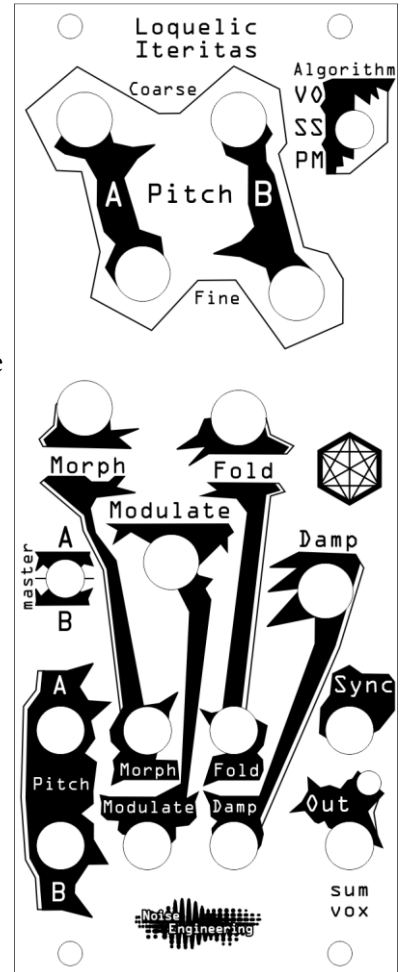

Noise Engineering

Loquelic Iteritas

Complex Digital Oscillator

Calibration

Loquelic Iteritas is best calibrated using a stroboscope and tuning octaves across the pitch range. Each pitch input has a separate calibration. The pitches can be isolated from each other by using the master switch to force the base pitch to be determined by only one input.

Voltage Supply

Loquelic Iteritas can run its processor on the 5V eurorack power rail to reduce noise and load on the 12V bus. There are three different versions of the CPU board two which use a switch to select and one which uses a jumper. For the switch versions gently push the switch tab in the direction of the desired rail to use. For the jumper version put the jumper from the center pin to the pin marked with the rail that is desired.

Voltage Selection

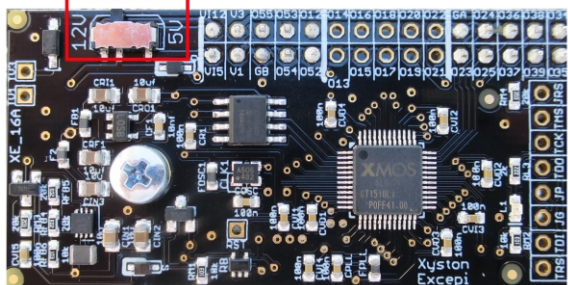

Voltage Selection

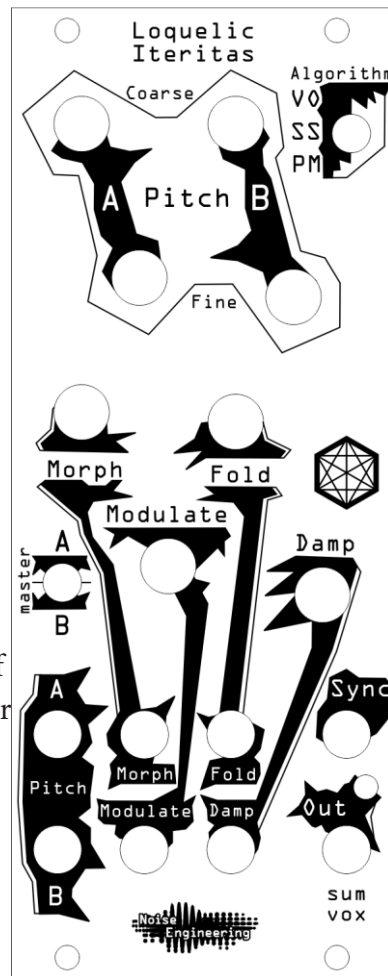
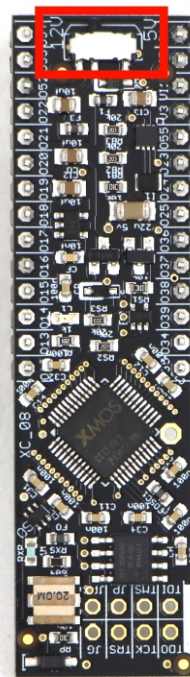
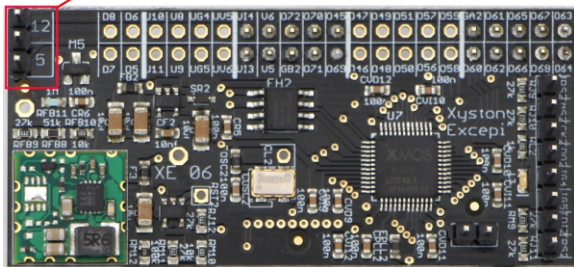

Noise Engineering

Loquelic Iteritas

Complex Digital Oscillator

Algorithm: VO

The VO algorithm is roughly based off of the VOSIM algorithm which I discovered while reading Curtis Roads's epic *Microsounds*. This algorithm amplitude modulates a carrier by an exponential to create a more complex harmonic structure. The simplest carrier is a sinusoid which produces a spectrum with a Gaussian distribution centered on the carrier. More complicated waveforms produce Gaussians around each harmonic, producing spectra similar to comb filtered noise.

Pitch A is the fundamental frequency of the carrier. Pitch B is the retrigger frequency of the exponential decay.

Interface

MORPH - changes the waveform of oscillator A

DAMP - sets the decay constant on oscillator B relative to its period

MOD - phase modulates oscillator A by oscillator B

FOLD - sets the wave fold threshold on the final wave folder

References

Kaegi, Werner, and Stan Tempelaars. "Vosim-a new sound synthesis system." *Journal of the Audio Engineering Society* 26.6 (1978): 418-425.

Roads, Curtis. *Microsound*. MIT press, 2004.

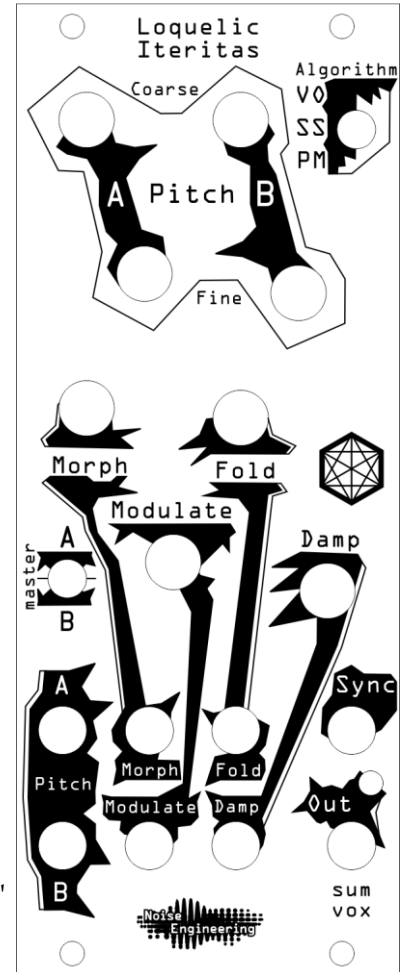

Loquelic Iteritas
Mode: VO

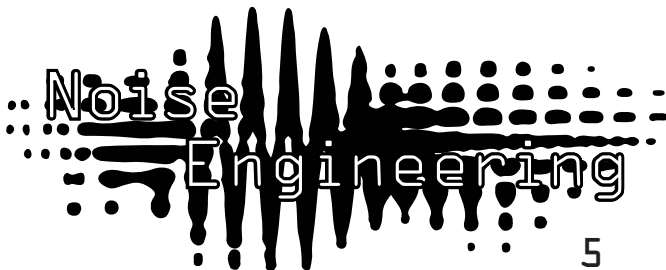
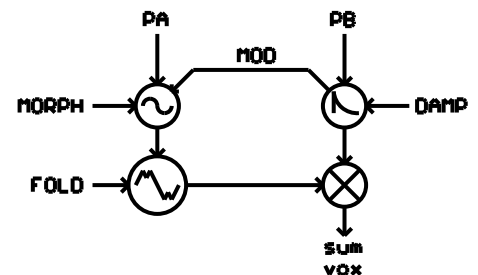

Noise Engineering

Loquelic Iteritas

Complex Digital Oscillator

Algorithm: SS

Algorithm SS is a highly modified version of summation synthesis originally developed by James Moorer. The premise comes from a simple mathematical equality between an infinite harmonic series and a relatively easy to compute expression.

Original equation:

$$\frac{\sin(\theta) - a \sin(\theta - \beta)}{1 + a^2 - 2a \cos(\beta)} = \sum_{x=0}^{\infty} a^x \sin(\theta + x\beta)$$

This equation allows a wide variety of musical spectra to be produced by only two parameters. Loquelic Iteritas generalizes the sinusoidal terms into multi-waveform oscillators: two of these track the two input pitches while the third tracks the difference of the two pitches and adds a wave folder for more harmonics. In the equation oscillator A is the left sinusoidal term in the numerator. Oscillator B is the sinusoidal term in the denominator.

Modified Equation:

$$\frac{\sin(w_A t) - a \sin(w_A t - w_B t)}{1 + a^2 - 2a \cos(w_B t)} = \sum_{x=0}^{\infty} a^x \sin(w_A t + x w_B t)$$

Interface

- MORPH** - changes the waveform of all oscillators
- DAMP** - sets the **a** parameter in the equality. This controls the generated spectra with higher values producing higher power harmonics.
- MOD** - phase modulates oscillator A by oscillator B
- FOLD** - sets the wave-fold threshold on the final wave folder

References

Moorer, James A. "The synthesis of complex audio spectra by means of discrete summation formulas." Journal of the Audio Engineering Society 24.9 (1976): 717-727.

Jolley, Leonard Benjamin William, ed. Summation of series. Courier Corporation, 2012.

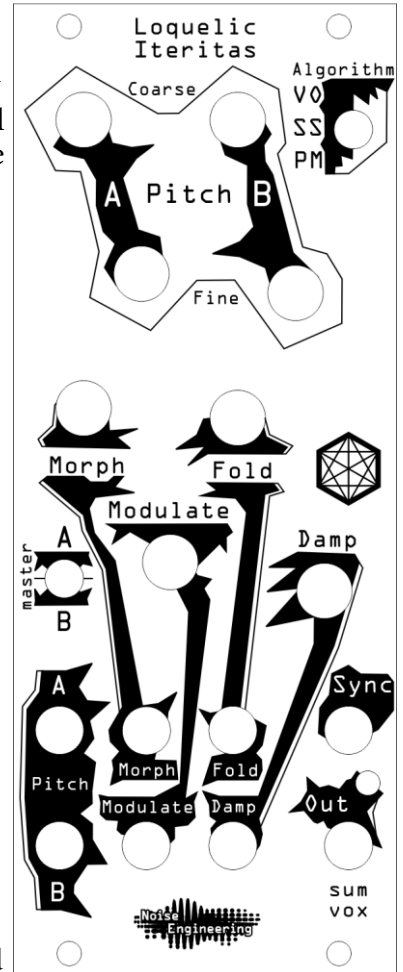

Loquelic Iteritas
Mode: SS

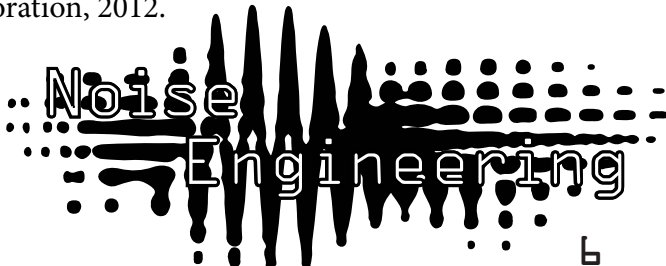
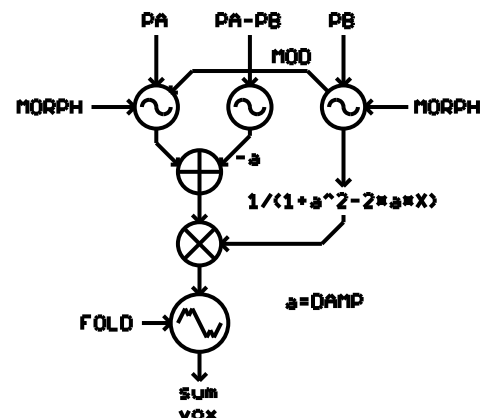

Noise Engineering

Loquelic Iteritas

Complex Digital Oscillator

Algorithm: PM

The PM algorithm is a naive time-domain two-oscillator phase-modulation implementation that combines both oscillators with amplitude modulation.

Interface

- MORPH - changes the waveform of both oscillators
- DAMP - blends between oscillator A and B through their product (AM)
- MOD - phase modulates the oscillators by each other
- FOLD - sets the wave-fold threshold on the final wave folder

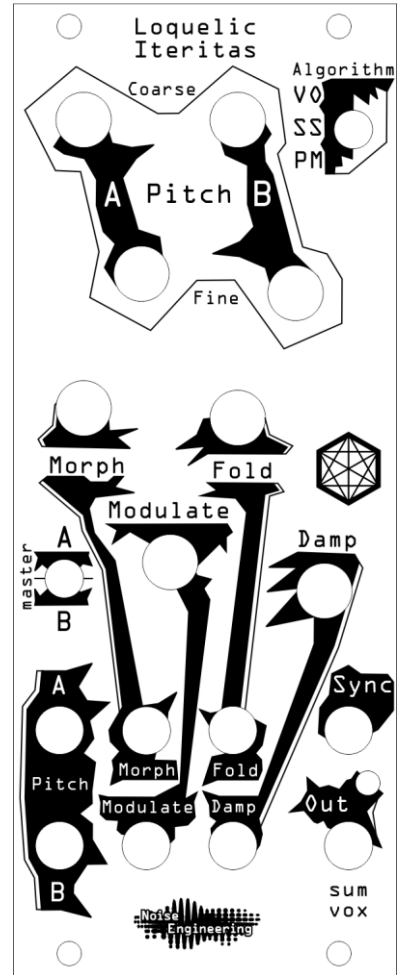

Loquelic Iteritas
Mode: PM

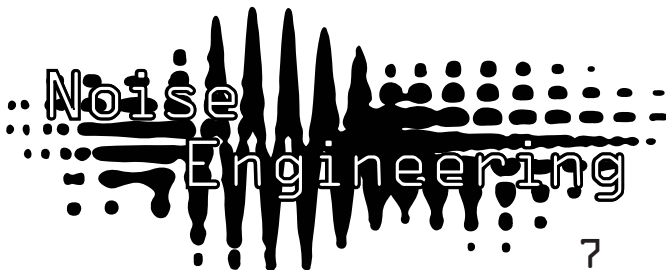
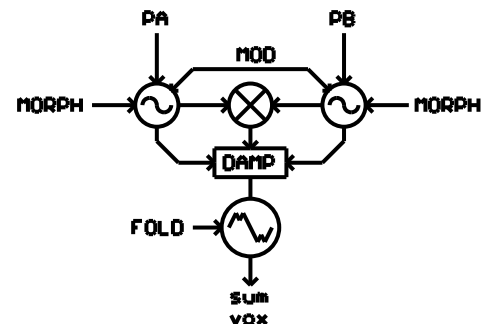

Noise Engineering

Loquelic Iteritas

Complex Digital Oscillator

Sample Rate

Loquelic Iteritas uses a unique multisampling technique to make aliasing more musical. By choosing a particular sample rate for a waveform that has a harmonic structure (all overtones are integer multiples of the fundamental) the alias power can be moved into frequencies that are also multiples of the fundamental and therefore more musical.

This gets complicated when synthesizing two oscillators at different pitches but using the same DAC. The compromise that Loquelic Iteritas makes is to give up the notion of a fixed sample rate and compute a time delay between samples based on both oscillators. For the single oscillator case, this delay is based entirely on pitch. If this delay is computed based on each oscillator's pitch, both sample rates can be interleaved by checking which oscillator's delay will be up first. This oscillator is then updated to its next timestep and an output value is computed based on both oscillator's output state. This makes no guarantees about exactly where the aliasing goes. It is an attempt to make the aliasing related in some way to the fundamental pitch.

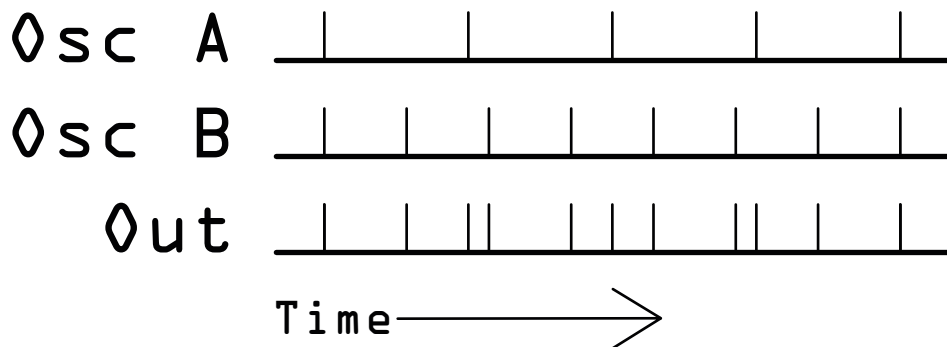

Two independent sample rates combine to form one irregular sample rate. Sample rate is not a constant.

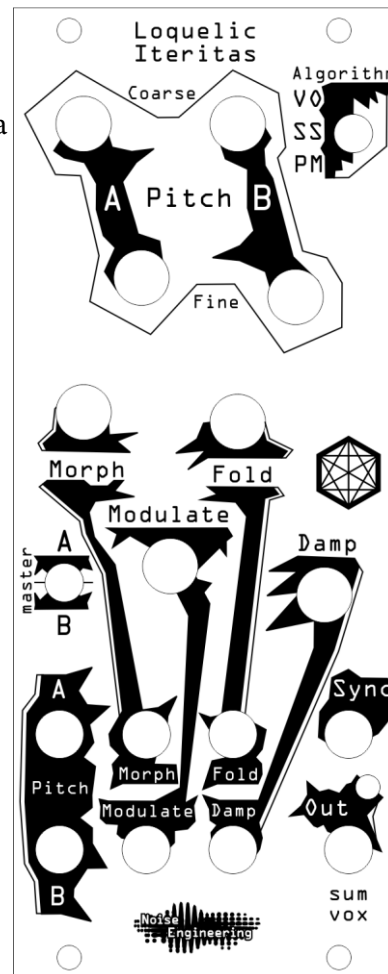

Noise Engineering

Loquelic Iteritas

Complex Digital Oscillator

Design Notes

Loquelic Iteritas has been in development for over two years. It was started at the same time as Basimilus Iteritas but has taken much longer to mature. Originally it was just a simple implementation based on VOSIM but I soon realized I could pack a lot more punch in this form factor and found two additional algorithms. Loquelic Iteritas was designed to be a functional oscillator for sound designers as well as for musicians. I wanted to maximize the possible sound space given the input controls going from simple calm sounds to extreme, even broken, sounds. The priority of tonal variance led to some sacrifices on the musical side such as the total pitch range.

The algorithms used are quite simple and are intentionally left naive as they often include interesting rough spots. For example, PM mode has a nasty half-sample-rate self oscillation under high modulation indexes that, when combined with the irregular sample rate, produces interesting, if quite harsh, results.

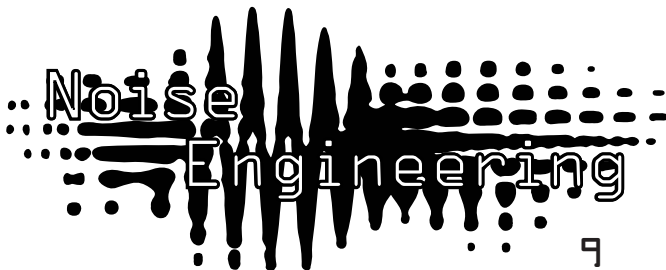
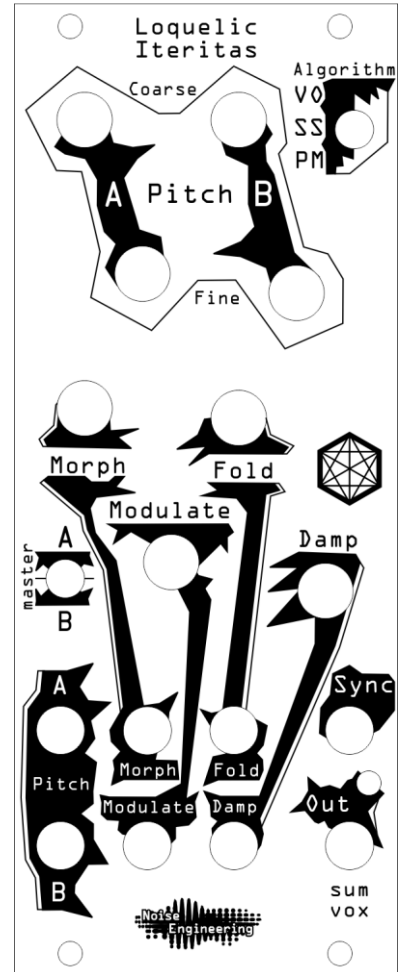

Noise Engineering

Loquelic Iteritas

Complex Digital Oscillator

Code

For reference I have included the core synthesis code for each algorithm. I am constantly amazed at how much sound variety such simple algorithms can produce and hope that others will appreciate their simplistic beauty. Note: code superfluous to the core algorithm has been removed.

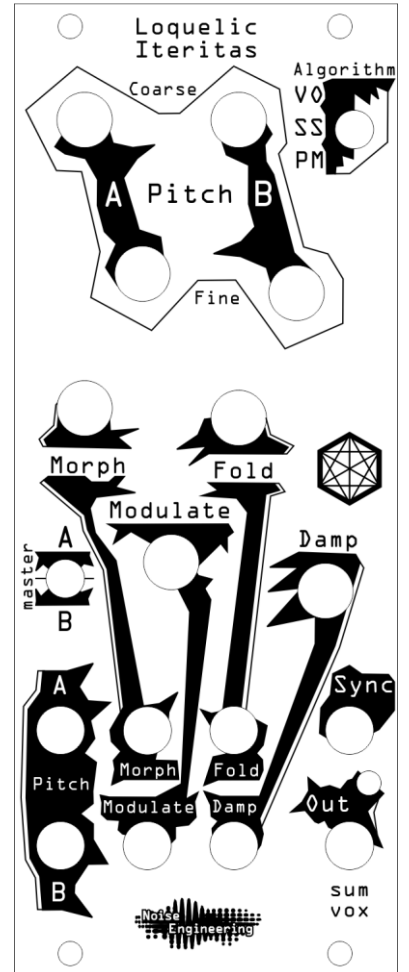

Noise Engineering

Loquelic Iteritas

Complex Digital Oscillator

Code: V0

```

unsigned LI_FrameV0()
{
    int delay;

    if((state.voOsc.delay - state.voR1) < (state.voEnv.delay - state.voR2))
    {
        if(state.voOsc.sync && state.current.syncSw == LI_SYNC_B)
        {
            NeAttackDecayReset(state.voEnv);
        }

        state.voOutC = NeMoscSample(state.voOsc, state.morph, state.voMod);
        delay = state.voOsc.delay - state.voR1;
        if(delay < 0) delay = 0;
        state.voR1 = 0;
        state.voR2 += delay;
    }
    else
    {
        state.voOutE = NeAttackDecayOscSample(state.voEnv);
        state.voMod = fix24_mul(state.voModAmt, 2 * (state.voOutE - FIX24_HALF));

        if(state.voEnv.reset && state.current.syncSw == LI_SYNC_A)
        {
            NeMoscReset(state.voOsc);
        }

        delay = state.voEnv.delay - state.voR2;
        if(delay < 0) delay = 0;
        state.voR2 = 0;
        state.voR1 += delay;
    }

    fix24 out = 0;
    out = NeFoldSample(state.fold, state.voOutC);
    out = fix24_mul(state.voOutE, out);
    out = fix24_mul(state.voMComp, out);
    out = fix24_soft_clip_poly(out);
    return fix24_to_u16_audio_delay(out, delay);
}

```

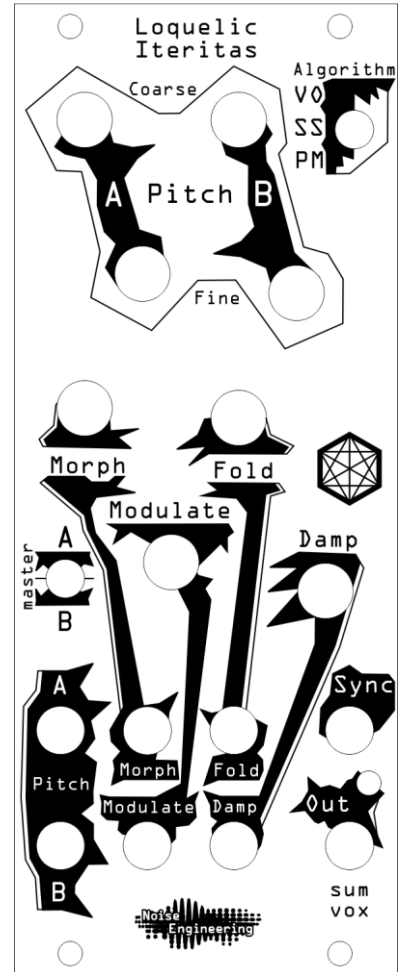

Noise Engineering

Loquelic Iteritas

Complex Digital Oscillator

Code: DS

```
unsigned LI_FrameDS()
{
    fix24 out = 0;
    int delay = 0;

    state.dsPb = NextC( state.dsPc, state.dsPm, state.dsPb);

    int dc = state.dsOscC.delay - state.dsRc;
    int dm = state.dsOscM.delay - state.dsRm;
    int db = state.dsOscB.delay - state.dsRb;

    if(dc <= dm && dc <= db) //dc is next
    {
        fix24 phaseC = fix24_mul(state.dsOutM, state.dsMod);
        state.dsOutC = NeMoscSample(state.dsOscC, state.morph, phaseC);
        delay = dc;
        if(delay < 0) delay = 0;
        state.dsRc = -delay;
    }
    if(dm <= dc && dm <= db) //dm is next
    {
        fix24 phaseM = FIX24_QUARTER + state.morph;
        state.dsOutM = NeMoscSample(state.dsOscM, state.morph, phaseM);
        delay = dm;
        if(delay < 0) delay = 0;
        state.dsRm = -delay;
    }
    if(db <= dm && db <= dc) //db is next
    {
        state.dsOutB = NeMoscSample(state.dsOscB, state.morph);
        delay = db;
        if(delay < 0) delay = 0;
        state.dsRb = -delay;
    }

    if(state.current.syncSw == LI_SYNC_A)
    {
        if(state.dsOscM.sync) NeMoscReset(state.dsOscC);
    }
    else if(state.current.syncSw == LI_SYNC_B)
    {
        if(state.dsOscC.sync) NeMoscReset(state.dsOscM);
    }

    state.dsRc += delay;
    state.dsRm += delay;
    state.dsRb += delay;

    fix24 a = state.dsA;
    fix24 a2 = fix24_mul(a, a);
    fix24 n = state.dsOutC - fix24_mul(a, state.dsOutB);
    fix24 d = FIX24_128TH + FIX24_ONE + a2 - 2 * fix24_mul(a, state.dsOutM);
    out = fix24_mul(FIX24_3RD, fix24_div(n, d));
    out = fix24_mul(state.morphScale, out);
    out = fix24_soft_clip_poly(out);
    out = NeFoldSample(state.fold, out);
    return fix24_to_u16_audio_delay(out, 2 * delay);
}
```

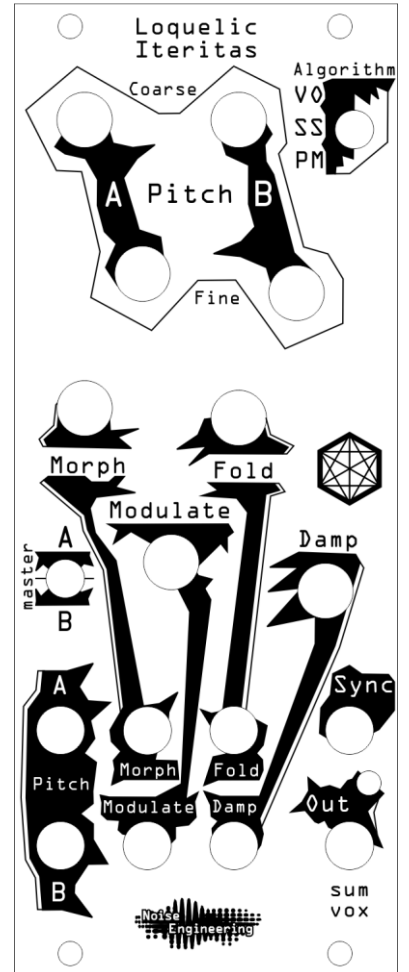

Noise Engineering

Loquelic Iteritas

Complex Digital Oscillator

Code: PM

```

unsigned LI_FramePM()
{
    fix24 out = 0;
    int delay = 0;

    int updateDelay1 = state.pmOsc1.delay - state.pmR1;
    int updateDelay2 = state.pmOsc2.delay - state.pmR2;

    if(updateDelay1 <= updateDelay2) //update whichever osc is due next
    {
        state.pmOut1 = NeMoscSample(state.pmOsc1, state.morph, state.pmPhase1);
        delay = updateDelay1;
        if(delay < 0) { delay = 0; }
        state.pmR1 = 0;
        state.pmR2 += delay;
    }
    else
    {
        state.pmOut2 = NeMoscSample(state.pmOsc2, state.morph, state.pmPhase2);
        delay = updateDelay2;
        if(delay < 0) { delay = 0; }
        state.pmR1 += delay;
        state.pmR2 = 0;
    }

    if(state.current.syncSw == LI_SYNC_A && state.pmOsc2.sync)
    {
        NeMoscReset(state.pmOsc1);
    }
    else if(state.current.syncSw == LI_SYNC_B && state.pmOsc1.sync)
    {
        NeMoscReset(state.pmOsc2);
    }

    state.pmPhase1 = (7 * state.pmPhase1 + fix24_mul(state.pmMod1, state.pmOut2))>>3;
    state.pmPhase2 = (7 * state.pmPhase2 + fix24_mul(state.pmMod2, state.pmOut1))>>3;

    fix24 am1 = fix24_mul(state.pmOut1, state.pmAM1);
    fix24 am2 = fix24_mul(state.pmOut2, state.pmAM2);
    fix24 am3 = fix24_mul(am1, am2);
    out = am1 + am2 + am3;
    out = fix24_soft_clip_poly(out);
    out = NeFoldSample(state.fold, out);
    return fix24_to_u16_audio_delay(out, delay);
}

```

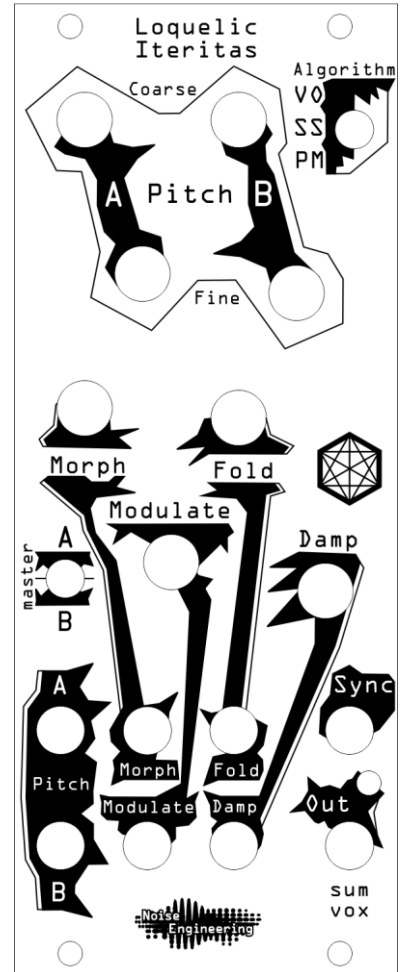

Noise Engineering

Loquelic Iteritas

Complex Digital Oscillator

Special Thanks

Kris Kaiser
Shawn Jimmerson
Cyrus Makarechian
William Mathewson
Mickey Bakas
Tyler Thompson
Alex Anderson

