

DEXIBELL

VIVO | H10MG |

premium home piano

Owner's Manual



HANDMADE
IN ITALY

Regulatory and Safety Information

Users in U.S.A

This product has been tested and found to comply with the limits for a Class B digital devices, pursuant to Part 15 of the FCC Rules. These limits are designed to provide reasonable protection against harmful interference in a residential installation. This equipment generates, uses, and can radiate radio frequency energy and, if not installed and used in accordance with the instructions, may cause harmful interference to radio communications. However, there is no guarantee that interference will not occur in a particular installation. If this equipment does cause harmful interference to radio or television reception, which can be determined by turning the equipment off and on, the user is encouraged to try to correct the interference by one or more of the following measures:

- Reorient or relocate the receiving antenna.
- Increase the separation between the equipment and receiver.
- Connect the equipment into an outlet on a circuit different from that to which the receiver is connected.
- Consult the dealer or an experienced radio/TV technician for help

This device complies with part 15 of the FCC Rules. Operation is subject to the following two conditions:

- 1) This device may not cause harmful interference.
- 2) This device must accept any interference received, including interference that may cause undesired operation.

FCC CAUTION: Any unauthorized changes or modifications not expressly approved by the party responsible for compliance could void the user's authority to operate the equipment.

Note: The manufacturer is not responsible for any radio or tv interference caused by unauthorized modifications to this equipment. Such modifications could void the user's authority to operate the equipment.

Radiation Exposure Statement

The available scientific evidence does not show that any health problems are associated with using low power wireless devices. There is no proof, however, that these low power wireless devices are absolutely safe. Low power Wireless devices emit low levels of radio frequency energy (RF) in the microwave range while being used. Whereas high levels of RF can produce health effects (by heating tissue), exposure of low-level RF that does not produce heating effects causes no known adverse health effects. Many studies of low-level RF exposures have not found any biological effects. Some studies have suggested that some biological effects might occur, but such findings have not been confirmed by additional research. This device has been tested and found to comply with FCC radiation exposure limits set forth for an uncontrolled environment and meets the FCC radio frequency (RF) Exposure Guidelines in Supplement C to OET65.

Users in Canada

This device complies with Industry Canada licence-exempt RSS standard(s). Operation is subject to the following two conditions:

- (1) this device may not cause interference, and
- (2) this device must accept any interference, including interference that may cause undesired operation of the device.

Le présent appareil est conforme aux CNR d'Industrie Canada applicables aux appareils radio exempts de licence. L'exploitation est autorisée aux deux conditions suivantes : (1) l'appareil ne doit pas produire de brouillage, et (2) l'utilisateur de l'appareil doit accepter tout brouillage radioélectrique subi, même si le brouillage est susceptible d'en compromettre le fonctionnement.

Under Industry Canada regulations, this radio transmitter may only operate using an antenna of a type and maximum (or lesser) gain approved for the transmitter by Industry Canada. To reduce potential radio interference to other users, the antenna type and its gain should be so chosen that the equivalent isotropically radiated power (e.i.r.p.) is not more than that necessary for successful communication.

Conformément à la réglementation d'Industrie Canada, le présent émetteur radio peut fonctionner avec une antenne d'un type et d'un gain maximal (ou inférieur) approuvé pour l'émetteur par Industrie Canada. Dans le but de réduire les risques de brouillage radioélectrique à l'intention des autres utilisateurs, il faut choisir le type d'antenne et son gain de sorte que la puissance isotrope rayonnée équivalente (p.i.r.e.) ne dépasse pas l'intensité nécessaire à l'établissement d'une communication satisfaisante.

Radiation Exposure Statement

The available scientific evidence does not show that any health problems are associated with using low power wireless devices. There is no proof, however, that these low power wireless devices are absolutely safe. Low power Wireless devices emit low levels of radio frequency energy (RF) in the microwave range while being used. Whereas high levels of RF can produce health effects (by heating tissue), exposure of low-level RF that does not produce heating effects causes no known adverse health effects. Many studies of low-level RF exposures have not found any biological effects. Some studies have suggested that some biological effects might occur, but such findings have not been confirmed by additional research. This device has been tested and found to comply with IC radiation exposure limits set forth for an uncontrolled environment and meets RSS-102 of the IC radio frequency (RF) Exposure rules.

Les connaissances scientifiques dont nous disposons n'ont mis en évidence aucun problème de santé associé à l'usage des appareils sans fil à faible puissance. Nous ne sommes cependant pas en mesure de prouver que ces appareils sans fil à faible puissance sont entièrement sans danger. Les appareils sans fil à faible puissance émettent une énergie radioélectrique (RF) très faible dans le spectre des micro-ondes lorsqu'ils sont utilisés. Alors qu'une dose élevée de RF peut avoir des effets sur la santé (en chauffant les tissus), l'exposition à de faibles RF qui ne produisent pas de chaleur n'a pas de mauvais effets connus sur la santé. De nombreuses études ont été menées sur les expositions aux RF faibles et n'ont découvert aucun effet biologique. Certaines études ont suggéré qu'il pouvait y avoir certains effets biologiques, mais ces résultats n'ont pas été confirmés par des recherches supplémentaires. Cet appareil a été testé et jugé conforme aux limites d'exposition aux rayonnements énoncées pour un environnement non contrôlé et respecte les règles d'exposition aux fréquences radioélectriques (FR) RSS-102 de l'IC.

VIVO | H10 MG |

premium home piano

Owner's Manual

Welcome to the reference manual of VIVO H10 MG and congratulations to purchasing this Digital Piano.

The flagship VIVO H10 MG Digital Piano uses Dexibell's latest technology to give players the ultimate piano sound.

This instrument is the perfect and accurate simulation of an acoustic grand piano, each element of this piano has been carefully designed to spread a warm acoustic environment in the room, just like a grand piano, reverberating the sound over the whole body of the instrument. The splendid grand piano cabinet adds a touch of splendor to any room.

*Thanks to the **88-note Progressive Hammer-Action keyboard with escapement** and high quality stereo-sampled piano sounds, VIVO H10 MG gives players the ultimate grand piano sound.*

*All sounds was recorded with **holophonic** method for an amazing 3D listening experience and reproduced using the new technology called **T2L (True to Life)**, based on interaction between Sampling and Modelling methods. Moreover, the sound quality has been raised-up to **24 bit - 48KHz** with an average of 5 times longer ever recorded samples (15" on lower piano notes). VIVO H10 MG reproduces a real grand piano also thanks to **unlimited notes polyphony** (320 oscillators).*

The real sustain pedal simulation is designed for good-feeling response, and allows subtle performance nuances to be expressed.

Reading this manual you will discover many other features such as sympathetic resonances, harmonics, noises, staccato sounds, timbre variances, etc, etc.

To ensure that you obtain the maximum enjoyment and take full advantage of the piano functionality, please read all sections of this owner's manual carefully.

Keep this manual handy for future reference.



Start to take advantage of valuable benefits available simply registering your product on www.dexibell.com.

- You can benefit of DEXIBELL's **3 years** extended warranty (*The extended warranty is subject to terms and conditions. Please refer to the related section*).
- Keeps you updated on special offers.
- You can be updated on any new software release and new sounds.
- and so much more!

For European countries



	<p>This Symbol indicates that in EU countries, this product must be collected separately from household waste, as defined in each region. Products bearing this Symbol must not be discarded together with household waste.</p>		<p>Tento symbol vyjadruje, že v krajinách EÚ sa musí zber tohto produktu vykonávať oddelene od domového odpadu, podľa nariadení platných v konkrétnej krajine. Produkty s týmto symbolom sa nesmú vyhazovať spolu s domovým odpadom</p>
	<p>Questo simbolo indica che nei paesi della Comunità europea questo prodotto deve essere smaltito separatamente dai normali rifiuti domestici, secondo la legislazione in vigore in ciascun paese. I prodotti che riportano questo simbolo non devono essere smaltiti insieme ai rifiuti domestici. Ai sensi dell'art. 13 del D.Lgs. 25 luglio 2005 n. 151.</p>		<p>Ez a szimbólum azt jelenti, hogy az Európai Unióban ezt a terméket a háztartási hulladéktól elkülönítve, az adott régióban érvényes szabályozás szerint kell gyűjteni. Az ezzel a szimbólummal ellátott termékeket nem szabad a háztartási hulladék közé dobni.</p>
	<p>Ce symbole indique que dans les pays de l'Union européenne, ce produit doit être collecté séparément des ordures ménagères selon les directives en vigueur dans chacun de ces pays. Les produits portant ce symbole ne doivent pas être mis au rebut avec les ordures ménagères</p>		<p>Tämä merkintä ilmaisee, että tuote on EU-maissa kerättävä erillään kotitalousjätteistä kunkin alueen voimassa olevien määräysten mukaisesti. Tällä merkinnällä varustettuja tuotteita ei saa hävittää kotitalousjätteiden mukana.</p>
	<p>Dieses Symbol bedeutet, dass dieses Produkt in EU-Ländern getrennt vom Hausmüll gesammelt werden muss gemäß den regionalen Bestimmungen. Mit diesem Symbol gekennzeichnete Produkte dürfen nicht zusammen mit den Hausmüll entsorgt werden.</p>		<p>Το σύμβολο αυτό υποδηλώνει ότι στις χώρες της Ε.Ε. το συγκεκριμένο προϊόν πρέπει να συλλέγεται χωριστά από τα υπόλοιπα οικιακά απορρίμματα, σύμφωνα με όσα προβλέπονται σε κάθε περιοχή. Τα προϊόντα που φέρουν το συγκεκριμένο σύμβολο δεν πρέπει να απορρίπτονται μαζί με τα οικιακά απορρίμματα</p>
	<p>Este símbolo indica que en los países de la Unión Europea este producto debe recogerse aparte de los residuos domésticos, tal como está regulado en cada zona. Los productos con este símbolo no se deben depositar con los residuos domésticos.</p>		<p>See sümbol näitab, et EL-i maades tuleb see toode olemprugist eraldi koguda, nii nagu on igas piirkonnas määratletud. Selle sümboliga märgitud tooteid ei tohi ära visata koos olmeprügiga.</p>
	<p>Dit symbool geeft aan dat in landen van de EU dit product gescheiden van huishoudelijk afval moet worden aangeboden, zoals bepaald per gemeente of regio. Producten die van dit symbool zijn voorzien, mogen niet samen met huishoudelijk afval worden verwijderd.</p>		<p>Ta simbol označuje, daje treba proizvod v državah EU zbirati ločeno od gospodinjiskih odpadkov, tako kot je določeno v vsaki regiji. Proizvoda s tem znakom ni dovoljeno odlagati skupaj z gospodinjiskimi odpadki.</p>
	<p>Este símbolo indica que nos países da UE, a recolha deste produto deverá ser feita separadamente do lixo doméstico, de acordo com os regulamentos de cada região. Os produtos que apresentem este símbolo não deverão ser eliminados juntamente com o lixo doméstico.</p>		<p>Šis simbols norāda, ka ES valstīs šo produktu jāievāc atsevišķi no mājsaimniecības atkritumiem, kā noteikts katrā reģionā. Profuktus ar šo simbolu nedrīkst izmest kopā ar mājsaimniecības atkritumiem.</p>
	<p>Dette symbol angiver, at i EU-lande skal dette produkt opsamles adskilt fra husholdningsaffald, som defineret i hver enkelt region. Produkter med dette symbol må ikke smides ud sammen med husholdningsaffald.</p>		<p>Šis simbolis rodo, kad ES šalyse šis produktas turi būti surenkamas atskirai nuo buitinių atliekų, kaip nustatyta kiekviename regione. Šiuo simboliu paženklinėti produktai neturi būti išmetami kaitų su buitiniemis atliekomis.</p>
	<p>Dette symbolet indikerer at produktet må behandles som spesialavfall i EU-land, iht. til retningslinjer for den enkelte regionen, og ikke kastes sammen med vanlig husholdningsavfall. Produkter som er merket med dette symbolet, må ikke kastes sammen med vanlig husholdningsavfall.</p>		<p>Symbolen anger att i EU-länder måste den här produkten kasseras separat från hushållsavfall, i enlighet med varje regions bestämmelser. Produkter med den här symbolen får inte kasseras tillsammans med hushållsavfall.</p>
	<p>Symbol oznacza, że zgodnie z regulacjami w odpowiednim regionie, w krajach UE produktu nie należy wyrzucać z odpadami domowymi. Produktów opatrzonych tym symbolem nie można utylizować razem z odpadami domowymi.</p>		<p>Tento symbol udává, že v zemích EU musí být tento výrobek sbírán odděleně od domácího odpadu, jak je určeno pro každý region. Výrobky nesoucí tento symbol se nesmí vyhazovat spolu s domácím odpadem.</p>

1 Important Safety Instruction

PLEASE READ CAREFULLY BEFORE PROCEEDING



WARNING

Always follow the following precaution listed below to avoid user to the risk of serious injury or even death from electrical shock, fire or other hazard .

Only use non-tropical weather

This unit and its AC adaptor can only be safely used in non-tropical weather. The operating temperature range is 5° - 40°C (41° - 104°F).



Do not repair, modify or replace parts by yourself

Do not attempt to repair the unit, modify or replace parts of the product. Please contact all the nearest Dexibell Service Center.



Do not disassemble or modify by yourself

Do not open the unit or its AC adaptor or attempt to disassemble or modify the internal component in any way.



Use only the supplied AC adaptor (DEXIBELL DYS6150-2400500W).

Use only the AC adaptor included with the unit. Connecting a different AC adaptor can cause serious damage to the internal circuitry and may even pose a shock hazard.



Use only the supplied power cord

Use only the AC power cord supplied with the AC adaptor included in the package.



Do not excessively bend the power cord

Do not excessively twist or bend the power cord otherwise you damage it. Damaged cords may cause fire and shock hazards!



Do not place the unit in an unstable location

Do not place the unit in a unstable position where it might accidentally fall over.



Take care not to allow liquid or foreign objects to enter unit; Do not place containers with liquid on unit

Do not place object filled with liquid (glass of water on this product. Never allow foreign objects (e.g., flammable objects, coins, wires) or liquids (e.g., water or juice) to enter this product. Doing so may cause short circuits, faulty operation, or other malfunctions.



Never place or store the product in the following types of locations

- Exposed to extreme cold or heat (such as in direct sunlight, near a heater, or in a car during the day)
- Subject to steam or smoke
- Damp (such washroom, baths, on wet floors)
- Subject to salt water exposure
- Exposed to rain
- Dusty or sandy
- Subject to extreme changes of temperature or humidity (The condensation may occur and water may collect on the surface of the instrument. Wooden parts may absorb water and be damaged)
- Subject to high levels of vibration and shakiness.



Do not drop the unit or subject it to strong impact

Do not drop the unit. Protect it from strong impact!



Do not connect the unit to an outlet with an unreasonable number of other devices

Do not connect the unit's power-supply cord to an electrical outlet with an unreasonable number of other devices. This could cause the outlet to overheat and possibly cause a fire.



Adults must provide supervision in places where children are present

When using the unit in locations where children are present, never leave the unit unattended. Keep a special watch over any children so that they don't mishandling of the unit can take place.



Avoid extended use at high volume

This unit, either alone or in combination with an amplifier and headphones or speakers, may be capable of producing sound levels that could cause permanent hearing loss. DO NOT operate for a long period of time at a high volume level, or at a level that is uncomfortable. If you experience any hearing loss or ringing in the ears, you should immediately stop using the unit, and consult an audiologist.



If you notice any abnormality turn off the unit immediately

Turn off the unit and remove the AC adaptor from the outlet when:

- If the AC adaptor, the power-supply cord, or the plug has been damaged
- If smoke or unusual smells occurs.
- If the product has been exposed to rain.
- If objects have fallen into, or liquid has been spilled into the unit.
- If the unit does not operate or exhibits a marked change in performance.
- If the unit has been dropped, or the enclosure of the product has been damaged.



Contact the nearest qualified Service Center.



CAUTION

Always follow the following precaution listed below to avoid user to the risk of serious injury or even death from electrical shock, fire or other hazard .

Grasp the plug connecting or disconnecting the AC adaptor

When removing the electric plug from the instrument or an outlet, always hold the plug itself and not the cord. Pulling by the cord can damage it.



Do not use wet hands to connect or disconnect AC adaptor

Never handle the AC adaptor or its plugs with wet hands when plugging into, or unplugging from, an electrical outlet.



Keep clean the AC adaptor's plug

At regular intervals, unplug the AC adaptor and using a dry cloth clean the adaptor's plug.

If the unit will be unused for an extended period of time, unplug the AC power cord from the AC outlet.



Keep cables from getting entangled

Try to prevent cords and cables from becoming entangled. Place all cords and cables away from children.



Before cleaning the unit, unplug the AC adaptor from the outlet

To avoid electric shock or damage the unit, before cleaning the unit, turn it off and unplug the AC adaptor from the outlet (p. 22).



If there is a possibility of lightning strike in your area, disconnect the AC adaptor from the outlet

If you know a thunderstorm is predicted in your area, disconnect the AC adaptor from the outlet.



Take care so as not to get fingers pinched by lid

Be careful to avoid catching fingers (yours, or others, especially children's) when opening or closing the lid. Adult supervision is recommended whenever small children use the unit.



Do not rest your weight on or place heavy objects on the unit.

Avoid to climb on top of, nor place heavy objects on the unit.



Cautions when moving this unit

- When transporting or moving the unit always use two or more people. Attempting to lift the unit by yourself may damage your back, result in other injury, or cause damage to the unit itself.
- The unit should be handled carefully, all the while keeping it level.
- Disconnect the power cord and all connected cables.
- Close the lid.



Place in a well ventilated location

The unit and the AC adaptor should be located so their location or position does not interfere with their proper ventilation.



Do not use in tropical climates

Use the unit and the AC adaptor only in a moderate climates (not in tropical climates).



Place near the socket outlet

This equipment should be installed near the socket outlet and disconnection of the device should be easily accessible



2 Relevant Indications

In addition to the items listed under "Important Safety Instruction" on p. 5, please read and observe the following:



Power supply related

- Do not plug this unit into the same electrical outlet used same by an electrical appliance that is controlled by an inverter or a motor (such as a refrigerator, washing machine or air conditioner). Doing so, can result an audible noise.
- The power adaptor may become warm after long hours of consecutive use. It can be a normal dissipation of heat through the adaptor casing. To reduce the possibility of overheating place the power adaptor on the floor in a well-ventilated location.
- Before connecting the unit to other equipment, turn off the power to all equipment. Otherwise, electrical shock or damage to the equipment may occur.
- If the unit is not operative for 120 minutes. to prevent unnecessary power consumption, this unit features an "AUTO OFF" function that automatically turns the unit off. If you don't want the unit to turn off automatically, change the "AUTO OFF" setting to "OFF" as described on "Auto OFF" (p. 70).

NOTE

The "AUTO OFF" setting is memorized when you switch off the unit.



Maintenance related

- To clean the unit, put a soft cloth in lukewarm water, squeeze it well, then wipe the entire surface using an equal amount of strength. Rubbing too hard in the same area can damage the finish.
- If your unit has a **polished finish**, it needs careful, periodic care. Dust should be removed using a soft feather or wool-type duster. Care should be taken not to apply pressure to the finish or to drag the dust across the finish, which can create fine scratches in the surface. Fingerprints or similar marks can be cleaned with a dampened soft cloth, followed by a dry cloth. In cases of stubborn greasy dirt, using a small amount of mild detergent (such as mild dishwashing liquid) on the damp cloth may help. Do not use any cleaners or detergents, since they might deteriorate the surface of the cabinet, and produce cracks. Do not use dusting cloths that contain chemicals.
- Do not wipe this unit with benzene, alcohol or solvent of any kind. Doing so may result in discoloration and/or deformation of the unit.



Related to appropriate location

- Do not place the unit near power amplifiers (or other equipment containing large power transformers) to avoid induced hum. In case of hum, to reduce the problem, change the orientation of your unit or place it away from the source of interference.
- Do not use this unit in the vicinity of a TV or radio. This unit may interfere with radio and television reception.
- When using this unit along with application on your iPhone/iPad, we recommend that you set "Airplane Mode" to "ON" on your iPhone/iPad in order to avoid noise caused by communication.
- Noise may be produced if cell phones are operated in the vicinity of this unit. In case of noise you should relocate such wireless devices so they are at a greater distance from this unit, or switch them off.
- Do not expose the unit to extreme cold or heat, to direct sunlight or near devices that radiate heat. Do not leave the unit inside a vehicle during the day. Extreme temperature can damage the unit.
- Take care when move the unit from one location to another with drastic changes in ambient temperature. Condensation can occur in the unit due to drastic change of temperature. Using the device while condensation is present can cause damage. If there is reason to believe that condensation might have occurred, leave the device for several hours until the condensation has completely dried out.
- Do not place, for long periods of time, vinyl, plastic or rubber objects on this unit. Such objects can discolor or otherwise harmfully affect the finish.
- Do not place objects for long period of time on top of the keyboard. This can be the cause of malfunction of the keys of the keyboard.
- Do not apply any stickers, decals or self-adhesive material to this unit. The glue is difficult to remove and solvents are damaging the exterior finish.
- Do not place object filled with liquid (glass of water on this unit. Avoid to use alcohol, perfume, hairspray, nail polish, etc., near the unit. In the event of liquid spill on the unit, swiftly wipe away the surface using a dry, soft cloth.



Related to repairs

- Always back up your data on a USB memories before you send this unit for repair to an authorized center. All data contained in the unit's memory may be lost. Important data should always be backed up, or written down on paper (when possible). Dexibell assumes no liability concerning such loss of data.



Related to external memories

- Insert the USB Memory (commercially available) into the slot with care and at the correct angle.
- Take particular care when handling USB Memory:
 - Always ground yourself to something metal before handling an USB Memory
 - Do not touch the pins of the USB Memory connector, or allow them to become dirty.
 - Do not subject the USB Memory to temperature extremes (e.g., direct sunlight in an enclosed vehicle)
 - Do not allow the USB Memory to become wet
 - Do not drop or subject it to excessive shock or vibration.
- Do not disconnect the USB Memory while writing and reading data (i.e., while the USB Memory indicator blinks).
- Never use USB hub to connect USB Memory to the unit.
- This unit allows you to use commercially available USB Memory. You can purchase such devices at a computer store, a digital camera dealer, etc
- The audio recording require a USB storage device to support high sustained transfer rates. Not all USB devices will guarantee flawless performance.



Other precautions

- The contents of memory could be lost due to malfunction or improper operation. To help prevent the loss of your data, we highly recommend that you periodically save a backup copy of important data you have stored in the unit's memory on another storage device. (e.g., USB memories).
- Unfortunately, an error may occur during the data restore previously stored in the USB memories. Dexibell shall not be liable for loss of profits or any consequential loss, loss of data.
- Do not use excessive force when handling unit's buttons, switches, sliders and controls and when use connectors and jacks. Rough handling can cause damage o malfunctions.
- Do not to apply strong pressure on the display.
- Always pull by the connector when disconnecting a cable, never pull the cable Not doing so you will cause shorts, or damage to the cable's internal elements.
- Keep the unit's volume levels down. The instrument should be used at a reasonable volume, to avoid disturbing neighbours, especially at night and in the early morning. Use headphones if you want to play your music loud or late at night.
- When you need to transport the unit, put it in its original packaging with padding in the box. Otherwise, you will need to use equivalent packaging materials. When transporting or moving the unit always use two or more people.
- To prevent possible damage, avoid applying excessive force to the music stand.
- For connecting this unit use cable low impedance cables. The use of cables that contain resistor can cause the sound level to be extremely low, or impossible to hear.



Related to copyright and trademarks

- Dexibell do not assume legal liability regarding any infringements of the user through the use of this unit.
- Recording, copying, distribution of copyrighted material (songs, live performance, etc.) belonging to a third party in part or in whole without the permission of the copyright owner is forbidden by law.
- Copyright © 2003 by Bitstream, Inc. All rights reserved. Bitstream Vera is a trademark of Bitstream, Inc.
- iPad® and iPhone® are registered trademarks of Apple Inc.
- App Store™ is an Apple's Service Mark
- Bluetooth® is registered trademarks of Bluetooth SIG, Inc.

Conventions Used in This Manual

The following symbols are used.

- NOTE** It indicates an important note; be sure to read it.
- MEMO** It indicates a memo regarding the setting or function; It's up to you read it.
- TIPS** It indicates a useful hint for operation; read it as necessary.

Contents

Important Safety Instruction	5
Relevant Indications	7
General Description	10
Panel Description	12
Connections Quick Guide	15
Quick Guide	16
Before You Start to Play	18
Connecting the AC Adaptor	18
Opening and Closing the Keyboard Lid	18
Opening the Keyboard Lid	18
Using the Music Rest	18
Closing the Keyboard Lid	19
Opening and Closing the Main Lid	19
Opening the Main Lid	19
Closing the Main Lid	19
Connecting the Pedal Cord	20
Listening Through Headphones	20
Connecting an Optional Microphone	20
Connecting an External Amplifier	21
Connecting the VIVO H10 MG to Your Computer	21
Connecting the VIVO H10 MG to an USB MIDI Keyboard (USB host function)	21
Connecting an USB Memory (commercially available)	21
How to Format the USB Memory	22
Safely Remove the USB Memory	22
Turning the Power On/Off	22
Turning the Power Off	23
Demo of the VIVO H10 MG	23
Basic Operation	24
About the Display and Cursor Operation	24
Main Page	24
Moving the cursor and setting parameter values	25
Assigning the Name You Specify	25
Selecting Tones	26
Grand Piano Mode	26
How to Customize and Save Your Grand Piano Mode Configuration	26
How to Select Tones	26
Most Frequently Used Tones (Favorite Tone)	26
Playing Two Sounds Over the Entire Keyboard (Layer)	27
Splitting the Keyboard Range and Playing Two Different Tones	27
How to change the Split Point	27
Mute the Lower Part	28
How to Play All Parts at the Same Time (Layer or Split mode)	28
How to Enable the Instrument to Play Three Tones	28
Play Three Tones in Split or Layer Mode	28
Four Hands Mode	30
How to Adjust the Volume Balance Between the Left and Right Piano Section	30
How to Choose the Tone for the 4 Hands Mode	30
Sound Effects	31
Going Around Sound Effects	31
Adding Reverb to the Sound	31
Other Functions	32
Transposing the pitch of the keyboard	32
Shifting the Tuning of a Keyboard Part in Octave Steps	32
Adjust the Volume of the VIVO H10 MG	32
Adjusting the volume of the internal speakers and audio output separately	32
How to Balance the Level of the Internal Speakers (Tweeter, Woofer, Table, Back)	33
Practicing with the Metronome	33
Metronome Settings	33
How to Adjust the Tempo Value	34
Use Tap Tempo Function to set the Tempo Value	34
Setting the Metronome Time Signature	34
Adjusting the Keyboard Response (Key Touch)	35
Customize the Global Keyboard Response (Key Touch)	35
Master Equalizer	35
Master Equalizer Preset	36
Saving Your User Preset	36
Restoring the Factory Settings (Factory Reset)	36
Restore the Factory Sounds	36
How to Protect Your Settings, Contents and Sounds List (Backup)	37
Backup Your Settings, Contents and Sounds List	37
Restore Your Settings, Contents and Sounds List	37
Additional Sound (Sound Library)	38
Remove and Add Sound Libraries	38
Removing a Sound Library	39
How To Load Sound Libraries From a USB Memory	39
Adding a Library	39
Sound Setup (Export/Import)	41
Exporting a Sound Set ("EXPORT SETUP")	41
Importing a Sound Set ("IMPORT SETUP")	41
Personalizing Your Sounds (T2L)	42
Making Slight Additions or Sound Alterations	42
Parameters to be edited	42
Adjusting the Keyboard Velocity Response According to the Sound	44
Using an Microphone (optional)	46
Adjusting the Microphone Level and the Amount of Vocal Effects	46
Microphone Preset	46
Selecting a MIC Preset	46
Saving Your MIC Preset	46
Adding Dedicate Vocal Effects	47
Reverb Effect	47
Delay Effect	48
Setting the Microphone Equalizer	48
Setting the Microphone Compressor	49
Setting the Low Cut Filter	49
Practice with Song Player	50
Playing a Song	50
Useful Song Controls	51
Recording Your Performance	52
Recording Your Music as audio data (WAVE)	52
How to Record your Performance over an Existing Audio Base (Overdub)	52
Working with the Memories	53
About the Memories and Memory Set structure	53
Saving Your Settings in the Internal Memory	53
Recalling your Settings from Internal Memory	53
Saving Your Settings in the USB Memory (commercially available)	53
Recalling your settings from an USB Memory	55
Renaming a Memory	55
Exporting a Memory Set in the USB Memory	55
Importing a Memory Set from the USB Memory	56
How to Automatically Recall Your Favorite Setting at the Power On	56
How to Customize the Grand Piano Mode	56
Playing with Audio Backing Tracks	58
Connecting your Mobile Device	58
Playing with X MURE Application	58
Wireless Function	59
Bluetooth® Audio and MIDI Connectivity	59
Turning on the VIVO H10 MG's Bluetooth Function	59
Connecting with the Mobile Device	59
Connecting an Already Paired Mobile Device	60
Using Bluetooth® Audio	60
Transferring Bluetooth® MIDI Data	60
MENU Options (Advanced Section)	62
General procedure	62
SETTING Parameters Group	63
T2L EDITOR	64
EFFECTS	64
MICROPHONE	64
SPEAKER LEVEL	64
CONTROL	64
TEMPO	65
TUNING	66
MEMORY	67
USB MEMORY	67
USB AUDIO	67
BLUETOOTH	68
MIDI	68
GLOBAL	70
SOUND LIBRARY	70
SOUND SETUP	70
FACTORY RESET	70
FACTORY SOUND	70
BACKUP	70
VERSION INFO	70
Appendix	71
Effects Types and Parameters List	71
VIVO H10 MG Tone List	74
Troubleshooting	75
Specifications	76
Index	78

3 General Description

a



Grand Acoustic System

Specially designated speakers system for an immersive spatial sound. 15 loudspeakers, a soundboard built in Italy in "Val Di Fiemme", 4 DSPs and 4 amplifiers guarantee you a perfect sound diffusion at 360 degrees like with a real grand piano.

b

Soundboard Vibration System

One of the essential aspects of a grand piano is the sympathetic resonance created by the vibration of the entire instrument thanks to a soundboard built in Italy in "Val Di Fiemme". VIVO H10 MG simulates the complex sympathetic tones created when string vibrations are propagated to the soundboard.

c

Progressive Hammer Action Keyboard with Escapement

Grand piano touch from the new exclusive Progressive Hammer Action Keyboard with Escapement, which associates the look and feel of wood with the durability of modern materials.

d

Elegant Wood Cabinet

Elegant finishes to complement your living room.



- e **Keyboard Lid**
Folding Keyboard Lid with soft closing and reclining blind.
- f **Grand Pedal System**
The pedals continually detect depression depth which lets players make minute adjustments to pedal depression and return, changing the depth and character of their piano sound. Every detail is perfectly simulated up to the noise generated by the pressure and release of the pedal, all as a grand piano.
- g **Ajustable Main Lid Positioning**
The raised Main Lid serves as a reflecting surface for the sound waves that radiate from the soundboard. Thanks to the short and long lid stick (g) the Main Lid can be manually raised or lowered. See "Opening and Closing the Main Lid" (p. 19).



4 Panel Description

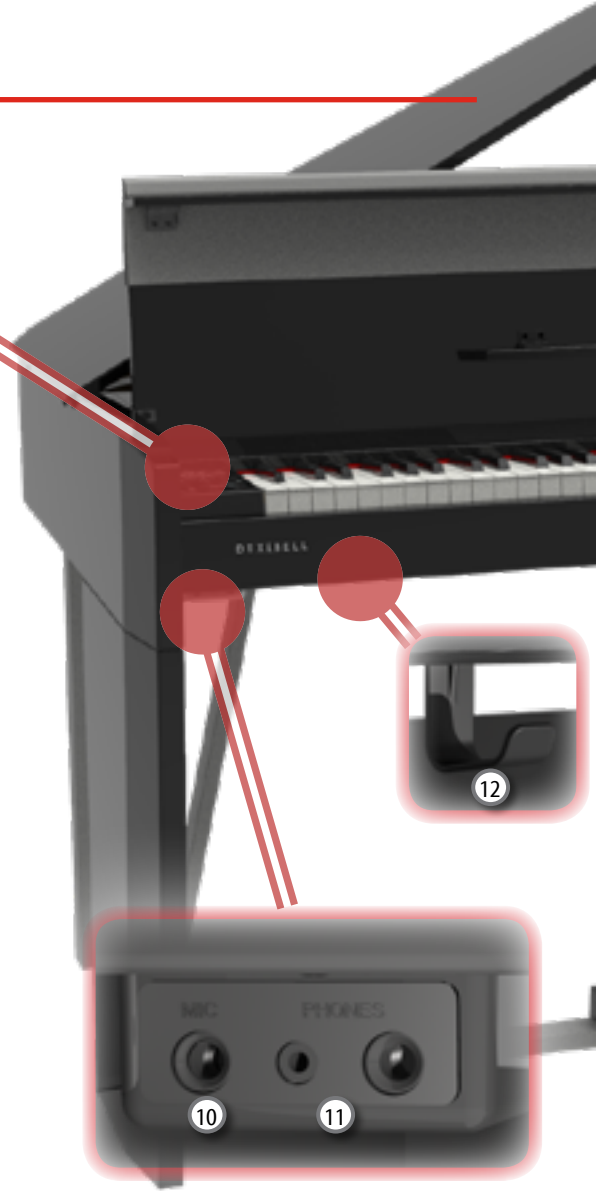
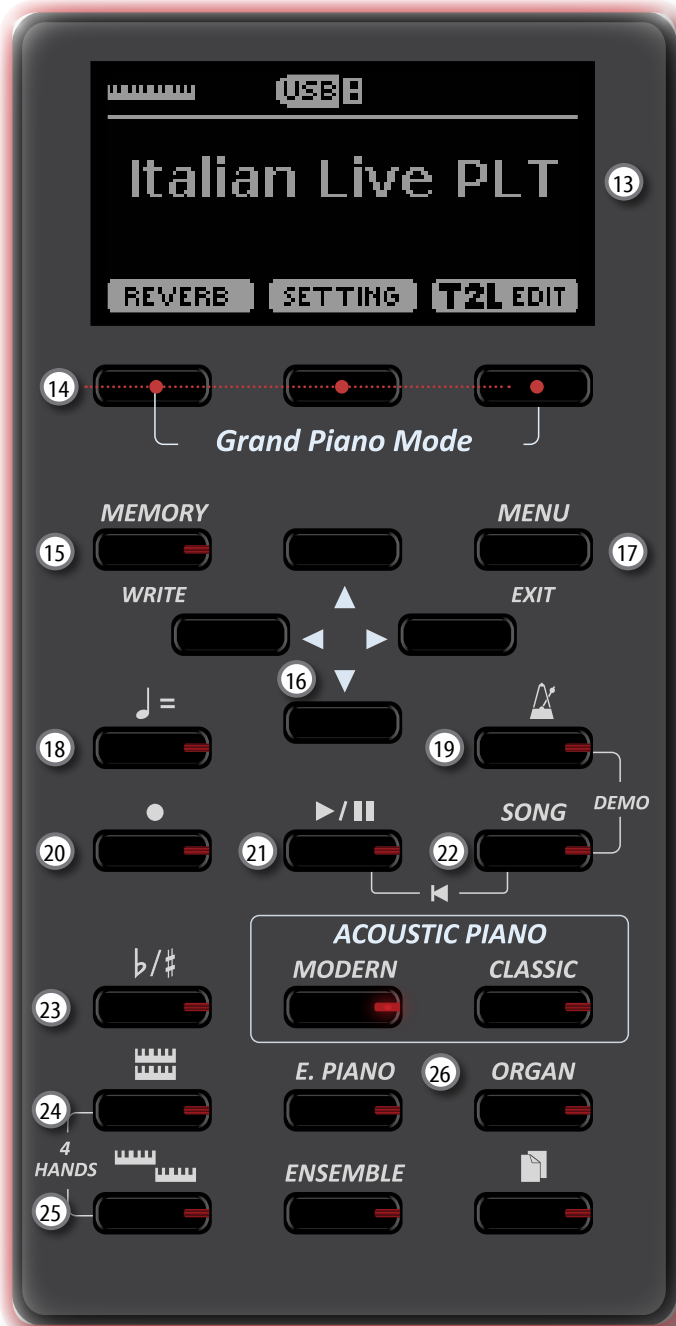

Turns the power on or off (p. 22).

With the factory settings VIVO H10 MG's power will automatically be switched off 120 minutes after you stop playing or operating the VIVO H10 MG.

If VIVO H10 MG's power has been turned off automatically, you can use the [POWER] switch to turn the VIVO H10 MG back on. If you don't want the power to turn off automatically, set the "AUTO OFF" parameter to "OFF" (p. 70).

NOTE

To avoid malfunctions, never disconnect the AC/DC adaptor while the instrument is turned on.

2 VOLUME

Use this knob to set VIVO H10 MG's overall volume. See "Adjust the Volume of the VIVO H10 MG" (p. 32).

3 MIC EFFECT

Use this knob to adjust the amount of the effects currently applied to the microphone.

4 MIC LEVEL

It adjust the level of the microphone connected to the MIC socket .

5 USB Computer Port

Use a USB cable to connect the VIVO H10 MG to your computer via this connector (p. 21).

6 USB Memory Port

Connect a commercially available USB Memory here.

If you connect to this port an USB MIDI keyboard or modules you can exchange MIDI data without a computer and without using two MIDI cables. See "Connecting the VIVO H10 MG to an USB MIDI Keyboard (USB host function)" (p. 21).

NOTE

* Carefully insert the USB Memory making sure that the connector on the device is appropriate and that it is connected in the proper direction.

* Dexibell does not recommend using USB hubs, irrespective of whether they are active or passive. Please connect only one USB Memory to this port

7 Damper Pedal

Use this pedal to sustain the sound (p. 64).

8 Sostenuto Pedal

The notes you are pressing when this pedal is depressed will be sustained, allowing future notes played to be unaffected (p. 65).

9 Soft Pedal

This pedal is used to reduce the volume and slightly changes the timbre (p. 65).



- 10 **MIC socket**
Use this socket to connect a microphone (unbalanced mono 1/4").
- 11 **PHONES output**
This is where you can connect one or two pairs of optional headphones. Doing so switches off the internal speakers.
- 12 **Headphones Hook**
Here you can hang your headphones.
- 13 **Display**
This display shows information related to your operation.
- 14 **Function buttons**
These buttons are used to select one of three functions/ options shows at the bottom of the display.
- 15 **MEMORY/WRITE button**
This button allows you shows the list of memories and then recall one of them. (See p. 53).
Pressing and holding this button to write a memory (See p. 53).
- 16 **Arrow buttons**
These buttons are used to navigate around the various menus, adjust values.
- 17 **MENU/EXIT**
This button allows you to open and close the menu page where you can view and select all available functions.
- 18 **♩ = (Tempo)**
Use this button to change the tempo of metronome.
You can also enter tempos simply by tapping your finger on the button.
- 19 **🔊 (Metronome)**
This button allows you to turn the metronome on or off.

- 20 **● (Rec)**
This button is used to start or stop the recording of your song (See p. 52).
- 21 **▶/||**
Press this button to start playing. Press it again to stop playing (See p. 50).
Press and hold it while pressing the [SONG] button to return to the beginning of the song.
- 22 **SONG**
This button allows you to switch in Song Mode (See p. 50).
Press it together with the 🔊 button to listen the demo song.
- 23 **b/#**
This button calls up the transposition function (See p. 32). Its settings can be applied to the keyboard.
If the button indicator doesn't light the instrument use its normal pitch.
- 24 **▬▬▬▬**
This button enable or disable the layer keyboard mode (See p. 27).
Press it together with the **▬▬▬▬** button to enable or disable the "4 HANDS" keyboard mode.
- 25 **▬▬▬▬**
This button enable or disable the split function (See p. 27).
Press it together with the **▬▬▬▬** button to enable or disable the "4 HANDS" keyboard mode.
- 26 **These buttons allow you to select tones by category**

Rear Side



Rear View

27 DC IN socket

Connect the supplied AC/DC adaptor here (p. 18).

28 AUDIO OUTPUT R jack

This socket allows you to connect an external amplified speakers.

29 AUDIO OUTPUT L/MONO jack

This socket allows you to connect an external amplified speakers.

NOTE

If you can/want to use only one channel on your external amplifier, connect this "L/MONO" socket to its input. For optimum sound quality, we recommend working in stereo, though.

30 Pedals Socket

Here is were you connect the pedal cable.

5 Connections Quick Guide

Peripheral Devices

NOTE

Before to connect your microphone to the MIC socket, rotate the [MIC LEVEL] knob counterclockwise to minimize the volume.

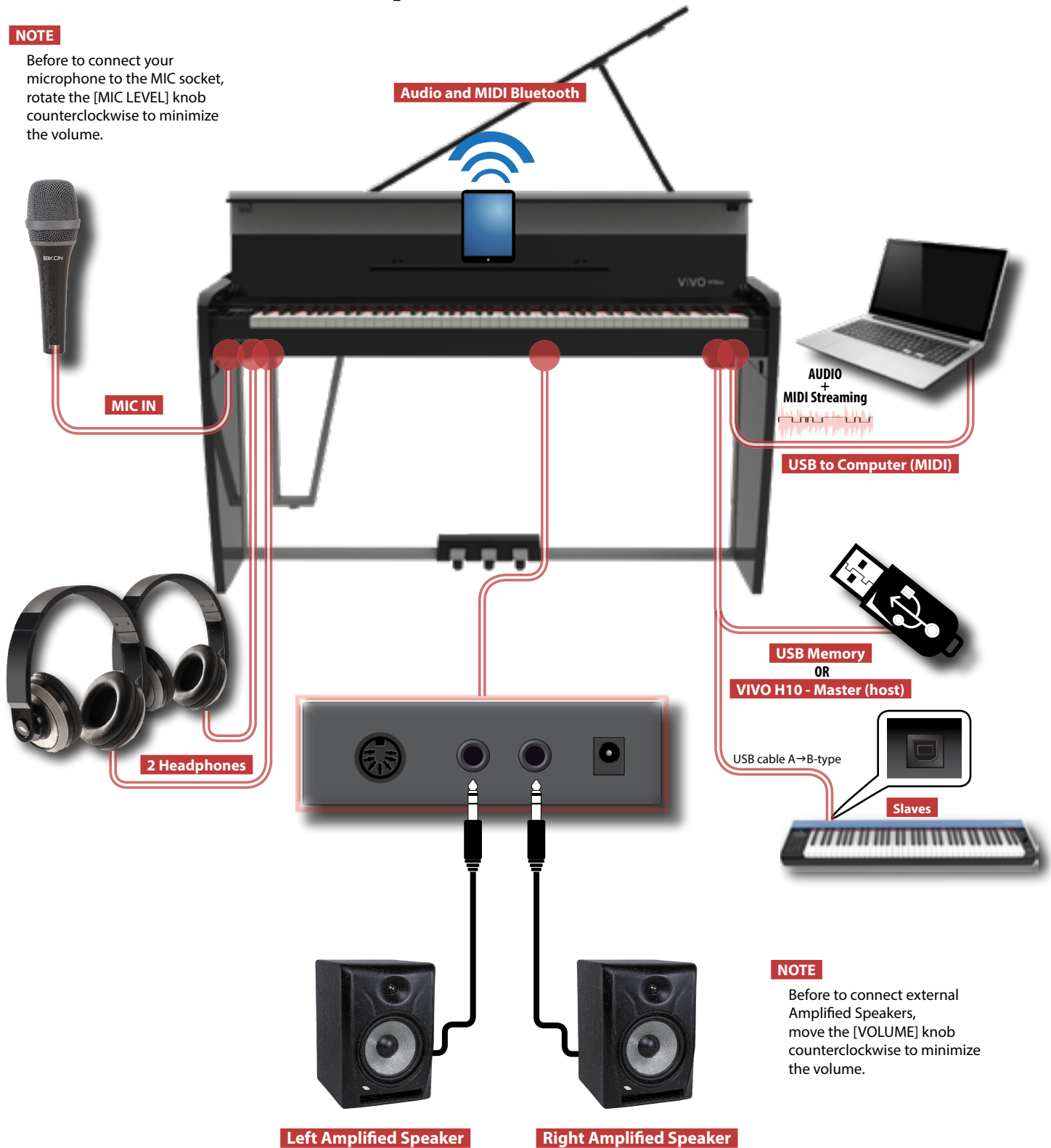

NOTE

Before to connect external Amplified Speakers, move the [VOLUME] knob counterclockwise to minimize the volume.

Reverberation

You can modify the reverberation to the sound to your liking.
Press the Function button that shows "REVERB" at the bottom of the display.
Use the [◀] [▶] buttons to adjust the amount of reverb of the selected part.

Function Buttons

Press these buttons to select functions/options shows at the bottom of the display.

Grand Piano Mode

When you want to reset various settings and play Grand Piano:
From the Main page, simultaneously press the first and last Function button.

Menu/Exit Button

Press this button to open and close the menu page where you can view and select all available functions..

Using the metronome

Press the [🎵] button to start the metronome.
To adjust the tempo and time signature use the [♩=] button.

Listening the Demo Song

Simultaneously press the [🎵] and [SONG] buttons.

Changing the Tempo/Time Signature

You can adjust the tempo of the metronome.
Press the [♩=] button to display the tempo page.
Use the [▲] [▼] buttons to select the tempo, the time signature field or an available preset tempo
Use the [◀] [▶] buttons to adjust the value.

Favorite Settings

HOW TO MEMORIZE YOUR FAVORITE SETTING

The VIVO H10 MG allows you to memorize your favorite settings for easy recall whenever they're needed. Up to 80 complete setups can be saved.
Press and hold the [MEMORY/WRITE] button to call up the memories page (the indicator of the button flashes).

Use the [▲] [▼] buttons to select one of the memory location.
Press the function button that shows "SAVE" at the bottom of the display
Use the [▲] [▼] and [◀] [▶] buttons to enter the desired name.
To confirm press the function button that shows "OK" at the bottom of the display

HOW TO RECALL YOUR FAVORITE SETTING

Press the [MEMORY] button to call up the memories page.
Use the [▲] [▼] buttons to select one of the memory location.
Press the "RECALL" function button under the display to select the memory.

p. 53

MEMO

Please note that it is also possible to memorize and recall directly on a USB Memory (commercial available). See p. 53.

p. 34

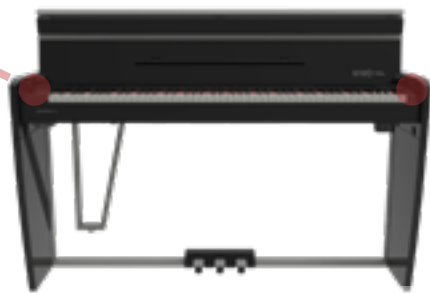
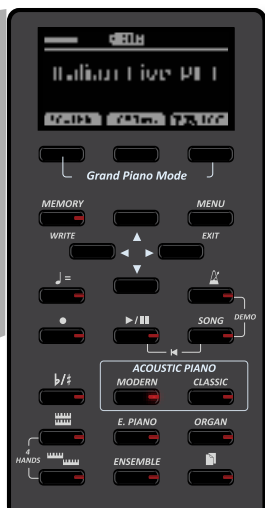

Turning the Power On

Press the VIVO H10 MG's [] switch.
 p. 22

Volume Adjusting

Adjust the volume rotating the knob

MIC Adjusting

Use the [MIC EFFECT] knob to adjust the amount of the effect currently applied.
 Use the [MIC LEVEL] knob to adjust the microphone input level.

Recording a Song

Press the [] button to start recording.
 Play your song.
 Press the [] button again to stop recording.
 p. 52

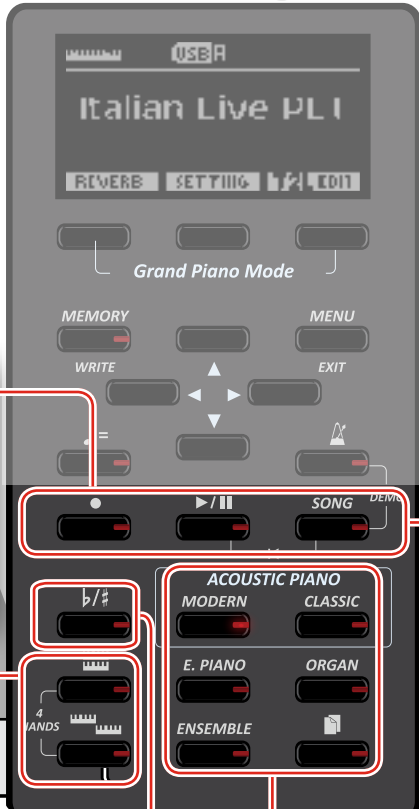

Selecting and Playing a Song

Press the [SONG] button to display the Song main page.
 Press the "SONG LIST" Function button
 Use the [▲] [▼] buttons to select a song.
 Press the "SELECT" Function button to load the song.
 Press the [▶/||] button to start playing.
 p. 50

Keyboard Mode Selection

At power-on, you play a piano sound over the entire keyboard (The [] and [] indicators are off).

Sound A

Press the [] button to play two different sounds over the entire keyboard.

Sound A + Sound B

Press the [] button if you want to play different sounds with your left and right hands.

Sound C | Sound A
 Split Point

To enter in "4 hands" mode, simultaneously press the [] and [] button.

Sound A
 Split Point

The keyboard modes listed above are by default. VIVO H10 MG has in addition two other modes: Play three different sound over the entire keyboard or, in split mode, play one sound with your left hand and two sounds with your right hand.
 p. 26

Selecting a Tone

Press one of the family tone buttons
 Press [▲] [▼] to select another desired tone in the list
 Press [◀] [▶] to select another family tone
 p. 26

HOW TO SET A FAVORITE TONE
 Press and hold the family button of the selected tone
 p. 26

Transposing the Keyboard

Press the [b/#] button to calls up the page where you can change the transposition value.
 Use the [◀] [▶] buttons to change the value.
 p. 32

7 Before You Start to Play

Connecting the AC Adaptor

1. Rotate the [VOLUME] knob counterclockwise to minimize the volume.



2. Connect the included power cord to the AC adaptor.
To an AC outlet



NOTE

Depending on your area, the included power cord may differ from the one shown above.

NOTE

Be sure to use only the AC adaptor (DEXIBELL DYS6150-2400500W) supplied with the unit. Also, make sure the line voltage at the installation matches the input voltage specified on the AC adaptor body. Other AC adaptors may use a different polarity, or be designed for a different voltage, so their use could result in damage, malfunction, or electric shock.

NOTE

If you won't be using the VIVO H10 MG for an extended period of time, disconnect the power cord from the electrical outlet.

NOTE

To avoid malfunctions, never disconnect the AC/DC adaptor while the instrument is turned on.

3. Connect the AC adaptor to VIVO H10 MG's DC IN socket positioned to the rear bottom panel.

REAR SIDE



Opening and Closing the Keyboard Lid

NOTE

- This unit is equipped with a safe closing system to avoid finger injuries when opening or closing the lid. Anyway be careful to avoid catching your fingers when opening or closing the lid. Adult supervision is recommended whenever small children use the unit.
- If you need to move the unit, make sure that the lid is closed to prevent accidents.

Opening the Keyboard Lid

WARNING

- Do not release the lid until it is fully opened.

1. Hold the front edge of the lid with both hands, then open the lid slowly until it reach the end-of-stroke position.

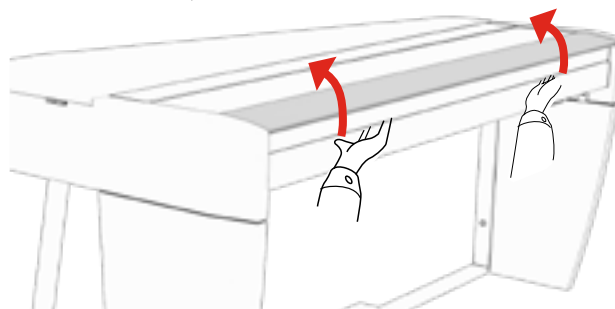

Using the Music Rest

Please find here below instruction regarding the opening and closing of the music rest.

Opening the Music Rest

1. Open the lid. See "Opening the Keyboard Lid" just above.
2. Pull down the sheet music holder (1) as in the illustration below.
3. To provide extra space for the music sheet, pull down the front part of the lid (2) as in the illustration below.

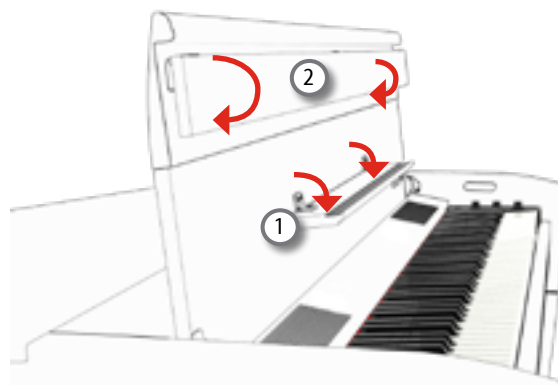

Closing the Music Rest

1. Pull up the sheet music holder (1) as in the illustration below.
2. Pull up the front part of the lid (2) as in the illustration below.

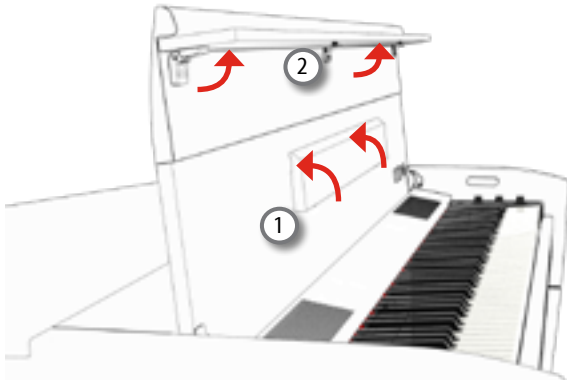

Closing the Keyboard Lid

WARNING

- Allow the lid to close automatically. Do not force the lid.
- Be careful to avoid catching your fingers when closing the lid. Adult supervision is recommended whenever small children use the unit.

1. Before closing the lid, close the sheet music holder. See "Closing the Music Rest" as described just above.
2. Hold the lid with both hands and slowly accompany it to close automatically.

Allow the lid to close automatically. Do not force the lid.

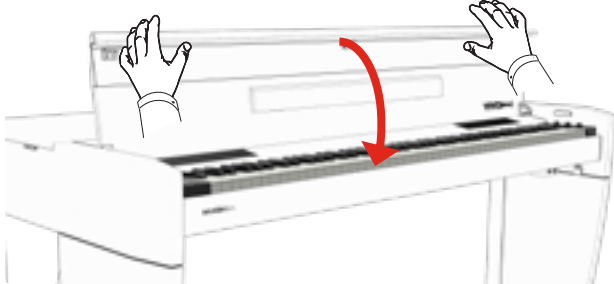

Opening and Closing the Main Lid

The raised main lid serves as a reflecting surface for the sound waves that radiate from the soundboard. Thanks to the short and long lid stick the main lid can be manually raised or lowered.

NOTE

- Do not let children open or close the main lid. When opening or closing the Main lid, take care not to pinch your fingers between the moving part and the body of the unit.
- If you need to move the unit, make sure that the main lid is closed to prevent accidents.

Opening the Main Lid

WARNING

When opening the cover, be careful not to open it too high.

Opening the lid too high may damage the piano, or cause the lid to fall.

Main Lid Positioning

The main lid has two opening positions: half opened and full opened. Use one of them to hold the lid open at the desired angle.

The piano has two lid sticks of differing lengths.

- The **short stick** in combination with the **socket (A)** keeps the lid **half open**.
- The **long stick** in combination with the **socket (B)** keeps the lid **fully open**.

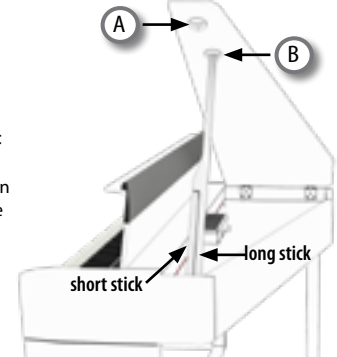

1. Grasp the right side of the main lid (1) with both hands, and slowly raise it.

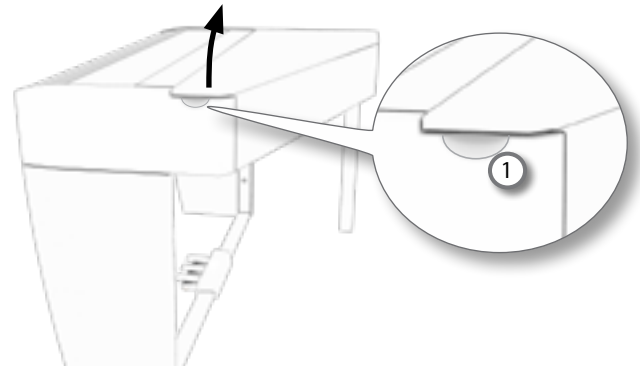

2. Use one hand to sustain the lid, raise the lid stick and fit it into the socket as in the illustrations.

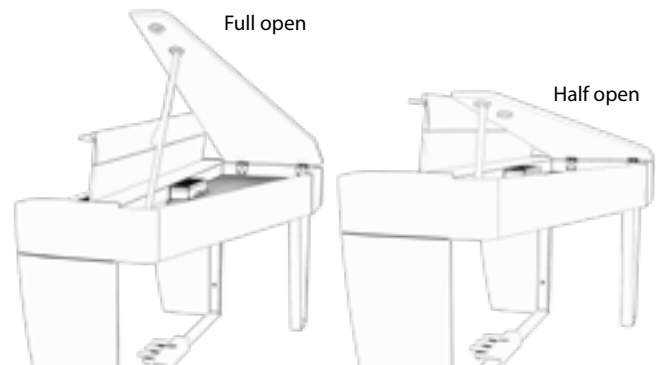

WARNING

Do not release the lid until the lid stick is completely locked in the socket. To prevent falling of the lid, be sure that the lid stick is stable in the socket.

Closing the Main Lid

NOTE

Do not let children open or close the main lid. When opening or closing the Main lid, take care not to pinch your fingers between the moving part and the body of the unit.

1. Grasp the right side of the main lid with a hand, and raise the main lid a little bit and, with the other hand, release

the stick from the socket.

- Place the stick in its rest position and slowly lower the lid to close it.

Connecting the Pedal Cord

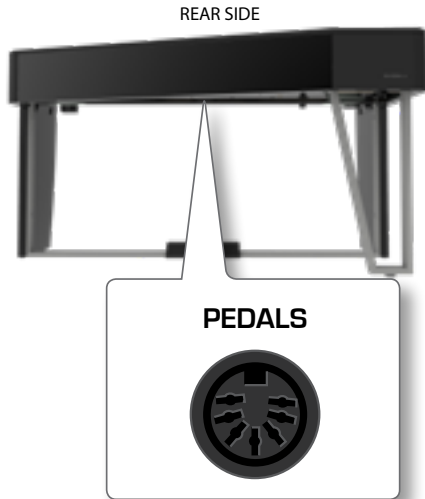

- Connect the pedal cord that come from the dedicated stand here.

For further information see the Assembling Manual.

Listening Through Headphones

You can use headphones to enjoy the VIVO H10 MG without disturbing those around you, such as at night.

- Here you can connect stereo headphones. VIVO H10 MG has two headphones jacks . Two people can use headphones simultaneously.



- Rotate the VIVO H10 MG's [VOLUME] knob to adjust the volume of the headphone.

Cautions when using headphones

- To prevent damage to the cord's internal conductors, avoid rough

handling. When using headphones, mainly try to handle either the plug or the headset.

- Your headphones may be damaged if the volume of a device is already turned up when you plug them in. Minimize the volume before you plug in the headphones.
- Excessive input will not only damage your hearing, but may also strain the headphones. Please enjoy music at a reasonable volume.

Connecting an Optional Microphone

By plugging an optional microphone in the MIC socket, you can use the VIVO H10 MG to accompany yourself while you sing.

MEMO

Your VIVO H10 MG allows you to record in WAVE format your performance including the microphone signal.

- Rotate the [VOLUME] knob counterclockwise to minimize the volume.

You should do so every time you need to connect or disconnect a microphone. Furthermore, only increase the setting if you actually wants to sing, and then set it back to the minimum value.

- Connect an optional microphone (unbalanced mono 1/4") in the "MIC" socket.



- Rotate the VIVO H10 MG's [VOLUME] knob to adjust the volume.

- Sing or talk into the microphone and gradually turn the "MIC LEVEL" knob to adjust the level of the microphone signal.

- Rotate the VIVO H10 MG's [MIC EFFECT] knob to adjust the amount of the current effects.

NOTE

Howling could be produced depending on the location of microphones relative to speakers. This can be remedied by:

- Changing the orientation of the microphone.
- Relocating microphone at a greater distance from speakers.
- Lowering volume levels.

Connecting an External Amplifier

You can connect the OUTPUT jack to external amplifier, stereo system, or other stereo audio device.

1. Rotate the [VOLUME] knob counterclockwise to minimize the volume.
2. Connect the VIVO H10 MG's OUTPUT jacks positioned to the right rear bottom panel to the inputs of your external amplifier.



Connecting the VIVO H10 MG to Your Computer

If you use a USB cable (commercially available) to connect the VIVO H10 MG to your computer, you can record and play audio and/or MIDI data by your MIDI software (DAW software).

NOTE

To use the USB audio streaming you need of a computer equipped with MAC OSX or LINUX, an iPad or iPhone.

NOTE

VIVO H10 MG does not support GM/GS standard.

What do you need to connect the VIVO H10 MG with your computer?

- USB cable (type A-male - type B-male: commercially available)

1. Use a standard USB cable (A→B-type connectors, commercially available) to connect the VIVO H10 MG to your computer as shown below.



NOTE

- Switch on the VIVO H10 MG before you start up the DAW software on your computer.
- Before to connect any other equipment, move the [VOLUME] knob counterclockwise to minimize the volume.

Now, the same sound coming out of the VIVO H10 MG can be recorded into your computer and the sound from your computer can be played from audio system of the VIVO H10 MG.

Connecting the VIVO H10 MG to an USB MIDI Keyboard (USB host function)

Using the following connection, your piano becomes a master (host). You can connect other keyboards or modules from any brand directly to the DEXIBELL USB "Memory" port and exchange MIDI data without a computer and without using two MIDI cables.

The connection consists of the following main components:

- Your DEXIBELL piano.
- One slave MIDI USB Devices as a keyboards.
- A physical bus represented by the USB cable that links the devices with the host.

H10 MG - Master (host)

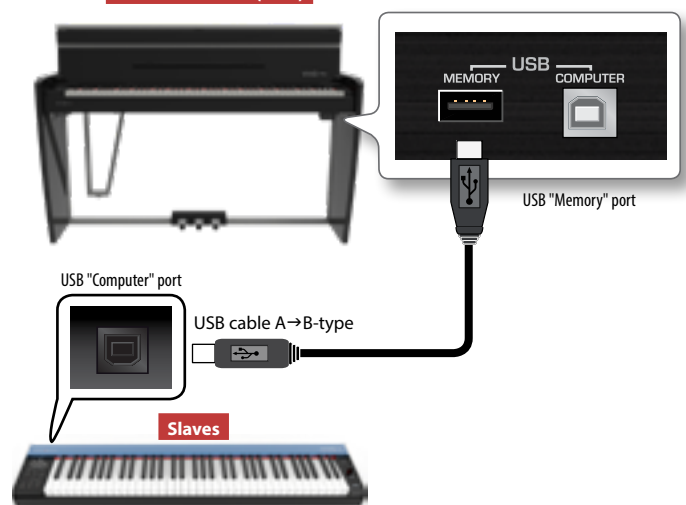

Connecting an USB Memory (commercially available)

1. Plug an USB Memory to the MEMORY port on the VIVO H10 MG's right panel located under the keyboard.

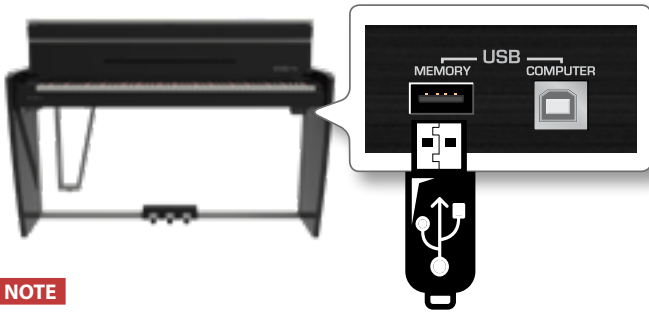

NOTE

Carefully insert the USB Memory making sure that the connector on the device is appropriate and that it is connected in the proper direction.

NOTE

The VIVO H10 MG supports all USB memory (FAT 32 formatted). Anyway, because there are so many USB memory on the market and it is almost impossible to check all types of memories, it could happen that a memory is not compatible with your instrument.

How to Format the USB Memory

1. Press the "MENU" button.
2. Use the [▲] [▼] buttons to select the "USB MEMORY" functions group and press the [▶] button to access them.



3. Use the [▲] [▼] buttons to select "FORMAT" and press the [EXECUTE] Function button to access the function.

The display shows:

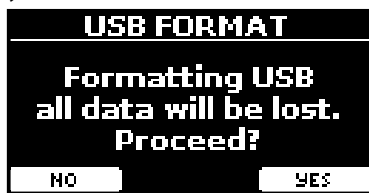

1. Press the "YES" Function button to format the USB Memory.
A confirmation message informs you that the USB memory has been formatted.

Safely Remove the USB Memory

NOTE

You should always safely eject the USB Memory before physically unplugging it from USB socket. Before to unplug the USB Memory use the "USB REMOVE" function.

1. Press the "MENU" button.
2. Use the [▲] [▼] buttons to select the "USB MEMORY" functions group and press the [▶] button to access them.



3. Use the [▲] [▼] buttons to select "REMOVE" and press the [EXECUTE] Function button to access the function.

The display shows:

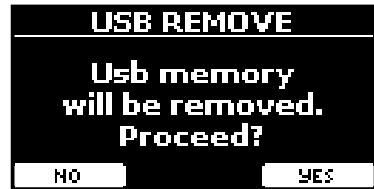

1. Press the "YES" Function button to safely remove the USB Memory.

Now you can unplug the USB Memory safely.

Turning the Power On/Off

Once everything is properly connected, be sure to follow the procedure below to turn on their power.

1. Rotate the [VOLUME] knob counterclockwise to minimize the volume.

NOTE

Before turning the VIVO H10 MG on/off, always be sure to turn the volume down. Even with the volume turned down, you might hear some sound when switching the VIVO H10 MG on/off.

However, this is normal and does not indicate a malfunction.

2. Press the VIVO H10 MG's [⏻] button located on the right panel to switch it on.

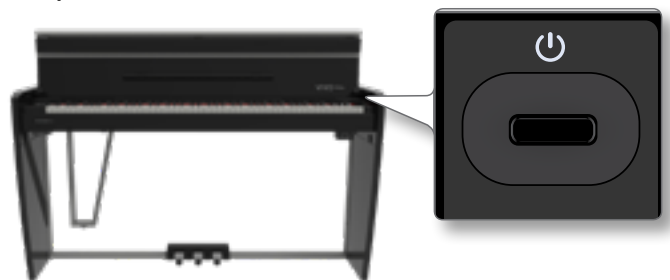

The power will turn on, a progress bar appear in the VIVO H10 MG's display.



After a brief interval, the main page will appear. and VIVO H10 MG will be ready to produce sound.



- Use the [VOLUME] knob to adjust the volume.

NOTE

This unit is equipped with a protection circuit. A brief interval (a few seconds) after power up is required before the unit will operate normally.

Turning the Power Off

- Rotate the [VOLUME] knob counterclockwise to minimize the volume.

NOTE

To avoid malfunctions, never disconnect the AC/DC adaptor while the instrument is turned on.

- Press the VIVO H10 MG's [⏻] switch.

A power off confirmation message appears:

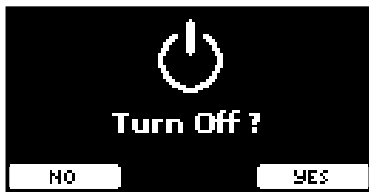

- Press the "YES" Function button to confirm.

The display shows the following message:



and the unit will turn off after few seconds.

If you do not want power off press the "NO" Function button.

NOTE

If you need to turn off the power completely, first turn off the [⏻] button, then unplug the power cord from the power outlet. Refer to "Connecting the AC Adaptor" (p. 18).

If you do not operate the unit for a certain period of time while the power is on, this unit turns off automatically.

If you don't want the power to turn off automatically, turn the "AUTO OFF" setting off!

With the factory settings, the unit's power will automatically be switched off 120 minutes after you stop playing or operating the unit.

Shortly before the VIVO H10 MG shuts down automatically, the display starts counting down the seconds. If you want to keep using the VIVO H10 MG at this stage, press any button.

If you don't want the power to turn off automatically, change the "AUTO OFF" setting to "OFF" as described on p. 70.

Demo of the VIVO H10 MG

Your VIVO H10 MG contains a demo that introduces all the best of its tones.

- Simultaneously press the [📶] and [SONG] buttons.



Playback starts automatically with the demo song.

- Press the [MENU/EXIT] button to leave the demo function.

NOTE

All rights reserved. Unauthorized use of this material for purposes other than private, personal enjoyment is a violation of applicable laws.

8 Basic Operation

About the Display and Cursor Operation

This section introduces the information that appear on the main page. Moreover this section illustrates how to navigate the menu.

Main Page

The VIVO H10 MG main page contains many useful information.

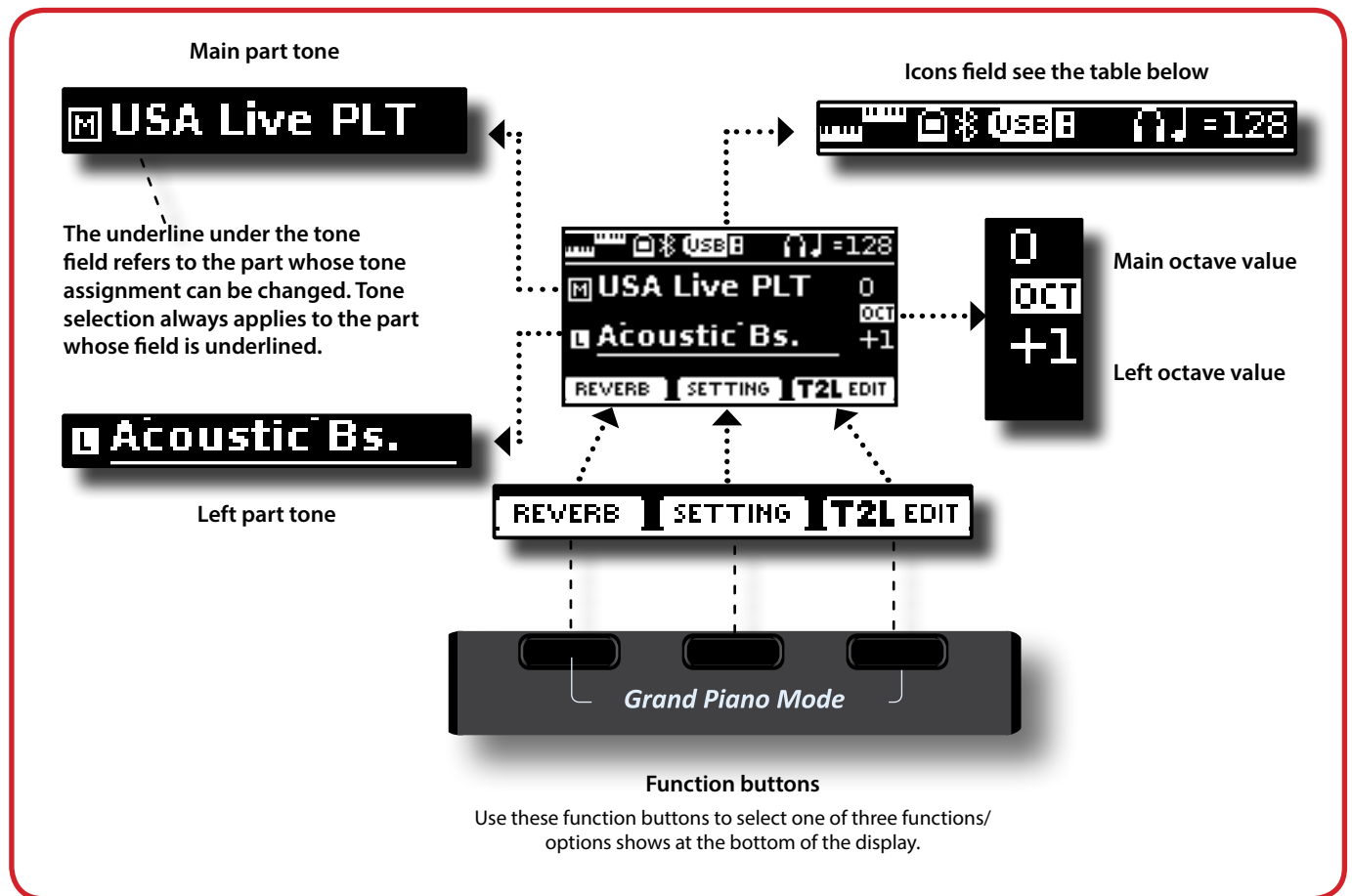

Icons Field	Explanation	Icons Field	Explanation
	Keyboard Mode:		A USB memory is connected to your unit
• Split			Bluetooth indicator • Steady icon: Connected to a device
• Layer			The internal speakers are switched off. See the parameter "Speaker" (p. 70).
• Split	See Global Parameters p. 70. 4 Hand is set: "Split+Layer"		An headphone is plugged into the PHONES output jack
• Layer			Tempo setting value
	A computer is connected to the VIVO H10 MG's USB "COMPUTER" port		

Moving the cursor and setting parameter values

1. Press the [MENU/EXIT] button to access to the available function groups.

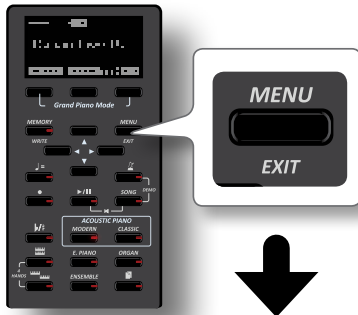

2. Use the [▲] [▼] buttons to select the desired function group.

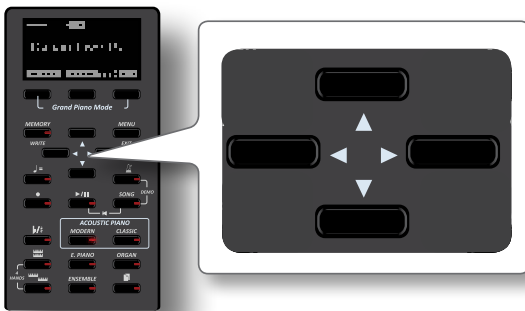

3. Press the [▶] button to enter in the selected function group.

4. Use the [▲] [▼] buttons to scroll the list of parameters. The selected parameter field is underlined.

5. Use the [◀] [▶] buttons to set the desired value.

6. Press the [MENU/EXIT] button to return to the main page.

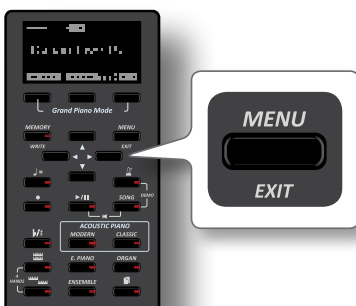

Assigning the Name You Specify

In many cases you'll have to assign a name to a file. In the following example, we will learn how to give a Memory name.

After the selection of saving a Memory, the display looks as follows:



A Memory name is suggested by the VIVO H10 MG.

1. Use the [▲][▼] buttons to select a different character.
2. Use the [◀] [▶] buttons to select the next character position you want to change, then use the [▲][▼] buttons again.
3. You can press the [A/a/#] Function button to switch between upper- and lower-case characters as well as numbers.

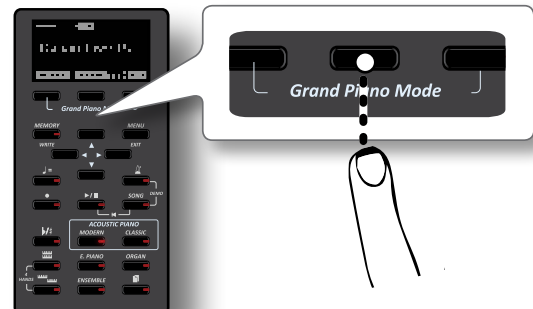

4. To delete the selected character, simultaneously press the central and right Function button.

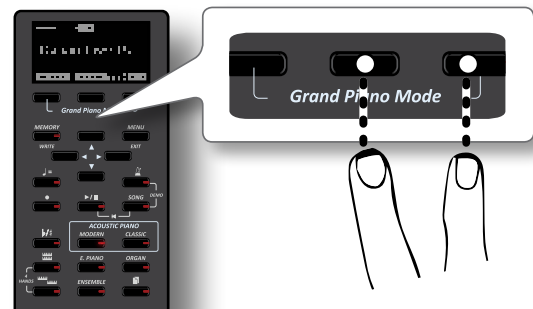

5. To insert a character, simultaneously At the same press the left and central Function button.

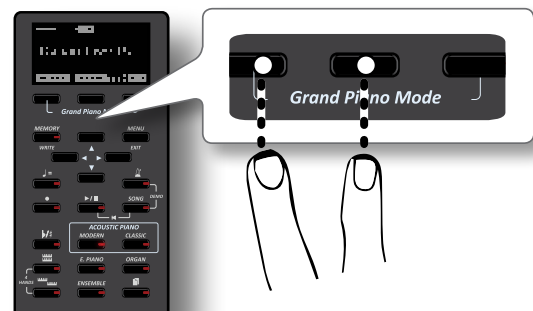

6. Repeat steps (2) and (3) to complete the name.

9 Selecting Tones

VIVO H10 MG has a wide selection of high quality tones arranged in six categories. In particular, thanks to new sound engine, the Piano tones are faithfully reproduced with all the subtle nuances of a real acoustic piano. The VIVO H10 MG allows you to assign any of the available tones to any of the three real-time parts. Tone selection always applies to the part (Main, Coupled or Lower) whose field is currently underlined in the main page.

The last sound you selected for that category is recalled. The button indicator lights and a temporary window shows the list of tones where the recalled sound is underlined:



In the example was pressed [MODERN] button.

2. While the tone window is active, use the [▲] [▼] buttons to select a tone in the same category.

If during normal operation the window closes automatically, press the Tone button again.

See page 74 for a list of available Tones.

3. Play the keyboard.

You'll hear the sound of the selected instrument.

MEMO

The last sound you select in each category is memorized temporarily and will be recalled every time you press the corresponding Tone button

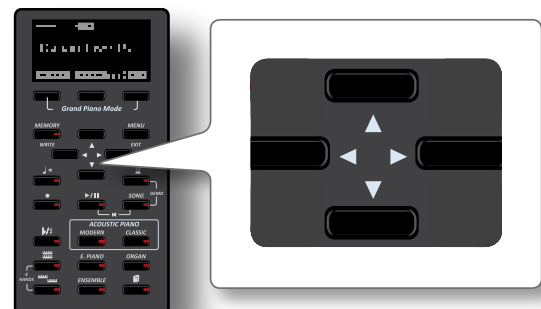

4. While the tone window is active, press the [◀] [▶] buttons to select the previous or next tone category or press another desiderate tone buttons.

After few seconds of inactivity of the change tone operation, the Main page is shown.

TIPS

A quick way to change a tone from the Main page: use the [◀] [▶] buttons to select a next or previous tone in the same category.

Grand Piano Mode

NOTE

At power-on, the instrument is automatically selected in Grand Piano Mode.

1. From the Main page, simultaneously press the first and last Function button.

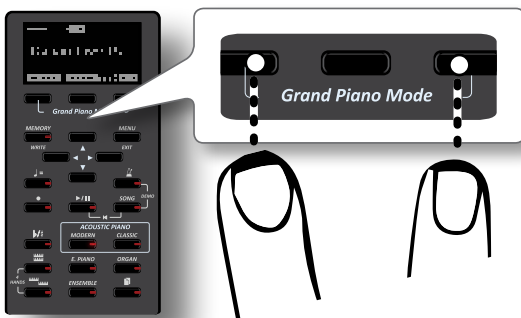

The "Grand Piano" tone is called and all various parameters are modified to play the best piano sound.

2. Play the keyboard to enjoy the piano sound.

All keyboard play piano sound.

Main Part



How to Customize and Save Your Grand Piano Mode Configuration

You have the possibility to customize the configuration of the Grand Piano mode by changing the tone and the various parameters of the instrument and save your configuration through the "SAVE AS G.P. MODE function.

For more information, please see "How to Customize the Grand Piano Mode" (p. 56).

How to Select Tones

1. Press the desiderate Tone button to select the sound category that you want to play.



Most Frequently Used Tones (Favorite Tone)

The "Favorite Tone" function lets you an easy recall of most frequently used sounds. You can memorize your Favorite Tone for each of six categories and recall it simply pressing the tone button. It will be helpful in a live performance situation.

1. Select a tone you prefer. See "Selecting Tones" (p. 26).
2. Press and hold the Tone button that contains the selected tone to memorize it.

Playing Two Sounds Over the Entire Keyboard (Layer)

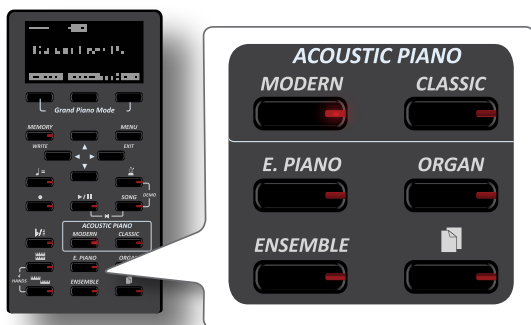

The display shows a confirmation message.

The position of the sound you selected is memorized and will be recalled every time you press the corresponding Tone button.

The instrument will remember your choice at the next power on.

Playing Two Sounds Over the Entire Keyboard (Layer)

In the previous paragraph "How to Select Tones", you learned how to select a Tone. Below you'll learn how to add a second sound over the entire keyboard.

1. Press the [] button to add a second tone (Coupled Part) over the entire keyboard.



The Coupled part [C] is automatically selected.

If the main page is displayed shows:



The Coupled part [C] field in the main page is underlined to inform you that the tone selection is applied on this part.

NOTE

For Tone selection, it would be a good idea to check on the main page which part is currently selected to ensure that you don't select a Tone for the wrong part.

2. Play the keyboard.
You'll hear the tones of Main part [M] and Coupled part [C] playing together.
3. To adjust the volume move the [VOLUME] knob.
4. To change a tone of the Coupled part, see "How to Select Tones" (p. 26).

5. To select the Main part, from the main page, use the [▲] [▼] buttons to select it.
6. To change a tone of the Main part, see "How to Select Tones" (p. 26).

Splitting the Keyboard Range and Playing Two Different Tones

Split mode enables you to play two different voices on the keyboard, one with the left hand and another with the right hand.

1. If you want to use your left and right hands to play different Tones, press the [] button.

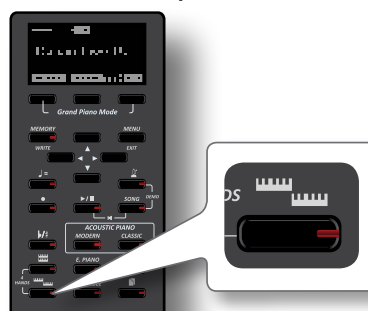

The Keyboard is divided into two sections. The region of the keyboard to the left of the split point becomes the Lower part, while the region of the keyboard to the right of the split point becomes the Main part.

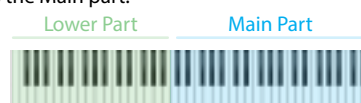

If the main page is displayed shows:



The Lower part [L] field in the main page is underlined to inform you that the tone selection is applied on this part.

2. Play the keyboard.
Turn the [VOLUME] knob to adjust the volume.
MEMO
The default split point is set between keys E3 and F3. To change the split point see "How to change the Split Point" (p. 27).
3. To change a tone of the Left part, see "How to Select Tones" (p. 26).
4. To select the Main part, from the main page, use the [▲] [▼] buttons to select it.
5. To change a tone of the Main part, see "How to Select Tones" (p. 26).

How to change the Split Point

1. Press and hold the [] button until the display shown the following page.



MEMO

You can reach the "SPLIT MODE" page also pressing [MENU/EXIT] button and select **SETTING**→**SPLIT MODE** function. See "Moving the cursor and setting parameter values" (p. 25).

- Use the [◀] [▶] buttons to change the split point.

Parameter	Setting
Split Point	F1 ~ C#7 Default: F3

- Press the "←" function button to return to the previous page or press [MENU/EXIT] button to go directly to the main page.

Mute the Lower Part

Use this function to mute the Lower part. This function can be useful when you want to play only an external device connected via MIDI.



- From the SPLIT page, press the "MUTE ON" Function button.

The note played on the Lower part don't produce sound.
The name of Function button change in "MUTE OFF"

- Press again the "MUTE OFF" Function to exit from mute function.

How to Play All Parts at the Same Time (Layer or Split mode)

Previously we saw how to play 2 different tones over the entire keyboard (layer) or splitting the keyboard (split). Now we will explain how to play three different tones in Split or Layer mode.

To enable the instrument to play all parts we need to set opportunely a global parameter, the "4hands" parameter.

How to Enable the Instrument to Play Three Tones

At default, the "4hands" global parameter is set in "4hands". Please see "4 Hands" (p. 70).

This means that, if we press the [] and [] button contemporary, we will access to "4 Hands" mode. See "Four Hands Mode" (p. 30).

To enable the instrument to play all parts (three tones) in layer or split mode we have to change the "4hands" global parameter

setting in "Split+Layer". Please see "4 Hands" (p. 70).

- Press [MENU/EXIT] button and select GLOBAL function. See "Moving the cursor and setting parameter values" (p. 25).
- Use the [▲], [▼] buttons to select the "4hands" parameter and use the [◀] [▶] buttons to set "Split+Layer".



Play Three Tones in Split or Layer Mode

You can play all parts (Main, Coupled and Lower) in layer or split mode.

- Simultaneously press the [] and the [] to enable the keyboard to play all parts (three Tones) at the same time.

Split Mode (default)

The Keyboard is divided into two sections. The region of the keyboard to the left of the split point becomes the Lower part, while the region of the keyboard to the right of the split point becomes the Main and Coupled part.



If the main page is displayed shows:



Layer Mode

- Press and hold the [] button until the display shown the following page:



- Use the [▲] [▼] buttons to select the "Split" parameter.
- Use the [◀] [▶] buttons to set the "Split" parameter to OFF.

Parameter	Setting
Split	OFF, ON Default: ON

Playing a note in the keyboard, the Main, Coupled and Lower parts play together.

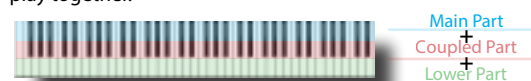

If the main page is displayed shows:



MEMO

To play the keyboard in split mode set again the "SPLIT" parameter to "ON".

10 Four Hands Mode

This function divides the keyboard into two sections, left and right zone, so that two people can play the same range of pitches, just as though there were two pianos.

When this mode is active, it is as if you had two separate 44-keys pianos with the same playing range and octave.



The right pedal act as damper pedal for the right piano section.

The left pedal must be assigned as damper pedal for the left piano section (see below).

Entering in "4 Hands" mode

NOTE

The "4Hands" mode is available if the "4Hands" parameter in the "GLOBAL" section is set in "4Hands" (default). Please see "4 Hands" (p. 70).

1. To enter in "4 hands" mode, simultaneously press the [] and [] button.

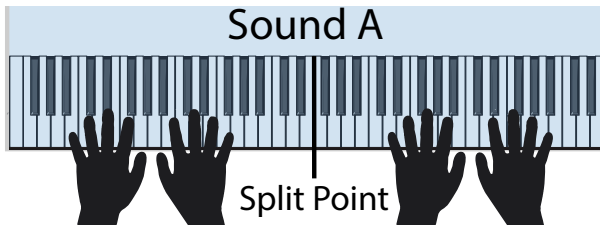

The instrument is now in the "4 Hands" mode.

NOTE

The default four hands mode split point is set between keys B3 and C4.

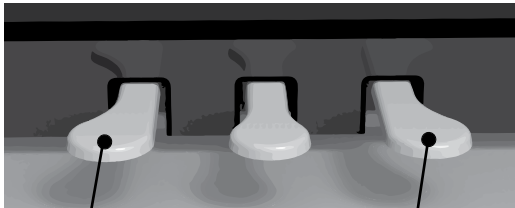

Assigning the damper for the left piano section.

To assign left pedal as damper for the left section, please follow the next instructions.



Damper pedal for the left section.
See below how to assign it.

Damper pedal for the right section

2. To enter in "4 hands" settings, press and hold the [] and [] button until the following page is displayed.

The display shows the "4 HANDS MODE" page:



3. By the [▲] [▼] buttons select the "Left Damper" parameter and press the [▶] button to set it "ON".

Now you are ready to have a four hand performance.

4. To leave the "4 hands" mode, simultaneously press the

[] and [] button or press one of the two buttons individually .

How to Adjust the Volume Balance Between the Left and Right Piano Section

In the "4 HANDS MODE" page you can adjust the "Balance" and "Output" parameters.



5. Use the [▲] [▼] buttons select the parameter that you want adjust.

6. Use the [◀] [▶] buttons to set the desired value.

Parameter	Setting	Explanation
Balance	90:10 ~ 50:50 ~ 10:90	Adjust the balance between the Left and Right piano section.
Output	<L R>, L&R	Select the audio signal output socket. <LR>: The sound of the Left piano section will be heard only from the left speakers. The sound of the Right piano section will be heard only from the right speakers. L&R: The sound of the Left and Right piano section will be heard from both speakers (Left and Right).

NOTE

If using headphones, you have the same behavior of speakers.

How to Choose the Tone for the 4 Hands Mode

You have the option to choose which tone will be recalled when entering 4 hands mode by the "Sound" parameter".



7. From the "4 HANDS MODE" use the [▲] [▼] buttons to select the "Sound" parameter and use the [◀] [▶] buttons to select your favorite tone.

NOTE

Please take note that this parameter is automatically saved in the memory Global area when the instrument is turned off.

11 Sound Effects

Going Around Sound Effects

VIVO H10 MG is quite simply a superlative instrument with the most advanced and best sound generation technology Dexibell has to offer. When you recall a Tone the instrument automatically add the appropriate effects for that sound.

Anyway, VIVO H10 MG give you the possibility to change type of effect or modify some parameter of it.

VIVO H10 MG manage two units of effectors (FX-A and FX-B) for each keyboard part (Main, Lower, Coupled).

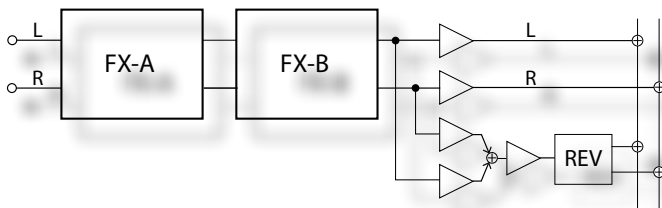

1. To access the "EFFECTS" page, press the [MENU] button and select the page using [▲], [▼] and [▶] button.

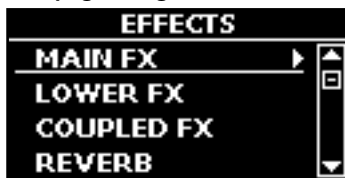

2. Select one of FX pages relative to the keyboard part ("MAIN FX", "LOWER FX" and "COUPLED FX").

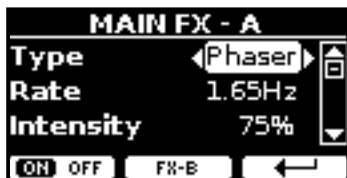

In the example we selected the "MAIN FX" page.

3. Use the [◀] [▶] buttons to choose the Type of effect. Press the "ON/OFF" Function button if you don't need the FX processor. For the list of effects see "Effects Types and Parameters List" (p. 71).
4. Use the [▲] [▼] buttons to select the parameter relative to the chosen effect.
5. Use the [◀] [▶] buttons to adjust the parameter value. For details about the parameters for each effects, see p. "Effects Types and Parameters List" (p. 71).
6. To edit the second FX processor, press the "FX-B" Function button.

Adding Reverb to the Sound

The reverb enables you to select various digital reverb effects that would add extra depth and expression to the sound to create a realistic acoustic ambience.

1. While the main page is displayed, press the left Function button to access the Reverb parameters.



The display shows the Reverb page:



MEMO

You can also select this function pressing [MENU] button → EFFECTS → REVERB.

2. Use the [▲] [▼] buttons to specify the part you wish to change the Reverb level.
3. Use the [◀] [▶] buttons to adjust the Reverb level.

Changing the Reverb Type

This parameter allows you to specify what kind of reverb effect you need.



1. While the Reverb page is displayed, press the "TYPE" Function button to access the Reverb Type page.



2. Use the [◀] [▶] buttons to choose the Macro Type you prefer.

The available Macro reverb types are:

Setting

Hall, Dark Hall, Mid Hall, Concert Hall, Large Hall, Chathedral, Arena, Cave, Chamber, Room, Venue, Ambience, Wooden Room, Brick Room, Studio Booth, Small Room, Living Room, Office, Warehouse, Music Club, Plate, Small Spring, Bright Spring, AmpSpring

12 Other Functions

Transposing the pitch of the keyboard

The Transpose setting allows the pitch of your digital piano keyboard to be raised or lowered in semi-tone steps.

This is particularly useful when accompanying instruments tuned for different keys, or when a song learned in one key must be played in another key or when a singer sing in a key different than the original music.

1. Press the b/\sharp button.

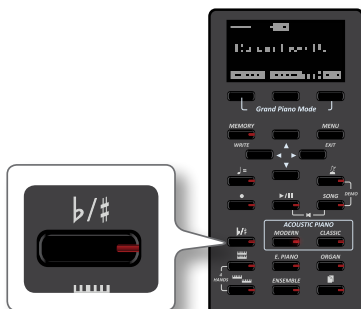

The display shown the following page.



2. Use the [\leftarrow] [\rightarrow] buttons to adjust the transposition value.

"Transpose" setting

-12 ~ 0 ~ +12 (semitone units)

If you set a value different than 0, the b/\sharp button indicator lights and the keyboard is transposed.

MEMO

You can also select this parameter pressing [MENU] button SETTING → TRANSPOSE.

Shifting the Tuning of a Keyboard Part in Octave Steps

The Octave function is an useful parameter that allows you to change the pitch of the selected part in octave steps (12 semitones at a time).



1. From the Main page, press the "SETTING" Function button to access the MAIN SETTING page.



The Main setting page can be also selected using [MENU] button → SETTINGS → MAIN SETTING.

2. Use the [\blacktriangle] [\blacktriangledown] buttons to select the "Octave" parameter.
3. Use the [\leftarrow] [\rightarrow] buttons to set the desiderate octave for the Main part.
In this page you can also adjust the audio level and mute the part. For details see the "MENU Options (Advanced Section)".
4. To change the Octave of another keyboard part, press the function button related to the part.

Adjust the Volume of the VIVO H10 MG

1. Use this knob to set VIVO H10 MG's overall volume.



At default, the "VOLUME" knob adjusts the volume of the internal speakers and adjusts the sound that comes out of the "OUTPUT L/MONO" sockets.

Adjusting the volume of the internal speakers and audio output separately.

Sometimes it can be useful to adjust the volume of the internal speakers only, leaving the volume of the external outputs unchanged or vice versa. To do this you need to set the parameter "Mode" appropriately:

1. Press [MENU/EXIT] button and select CONTROL → VOLUME function. See "Moving the cursor and setting parameter values" (p. 25).

The following page is shown:



If you rotate the Volume knob it adjusts the volume of the internal speakers and adjusts the sound that comes out of the "OUTPUT R-L/MONO" sockets. This is the default behavior.

2. Use the [\leftarrow] [\rightarrow] buttons to set the "Mode" parameter to "Int" instead to "Int.+Ext".

How to Balance the Level of the Internal Speakers (Tweeter, Woofer, Table, Back)



Now, if you rotate the VOLUME knob it adjust the volume of the internal speakers only. The volume of the external "OUTPUT R - L/MONO" sockets is fixed to 127. To adjust the volume of the "OUTPUT R - L/MONO" sockets you need to change the "Ext. Level" parameter.

- Use the [▲] [▼] buttons to select the "Ext. Level" parameter.
- Use the [◀] [▶] buttons to set the desiderate volume for the "OUTPUT R - L/MONO" sockets.

Parameter	Setting	Explanation
Mode	Int.+Ext, Int	Sets the Volume mode: Int.+Ext: The Volume knob adjusts the volume of the internal speakers and adjusts the sound that comes out of the "OUTPUT L/MONO" sockets. Int: The Volume knob adjusts the volume of the internal speakers only.
Ext. Level	0~127	Adjust the volume of the "OUTPUT R - L/MONO" sockets.

NOTE

These parameters are automatically saved in the memory Global area when the instrument is turned off.

How to Balance the Level of the Internal Speakers (Tweeter, Woofer, Table, Back)

The VIVO H10 MG's internal amplification has been designed to simulate a real grand piano. The amplification has been specially adjusted by the factory to achieve this but, if you want, you can adjust the loudspeaker amplification level to your taste. You can emphasize the mid-high frequencies by increasing the volume of the Tweeters or emphasizing the bass by raising the level of the woofers. You can increase or decrease the intensity of the soundboard vibrations (Table) and the volume of the rear speakers box (Back).

MEMO

If you wish, when the lid is closed, you can choose whether to exclude the amplification of the soundboard and the rear speakers box. See "Lid Sensor" (p. 70).

- Press [MENU/EXIT] button and select SPEAKER LEVEL function. See "Moving the cursor and setting parameter values" (p. 25).

The following page is shown:



- Use the [▲] [▼] buttons to select the parameter.
- Use the [◀] [▶] buttons to set the desiderate value.

Parameter	Setting	Explanation
Woofer	-6db ~ +2db	Adjusts the amplification volume of the Woofer speakers.
Tweeter	-6db ~ +2db	Adjusts the amplification volume of the Tweeter speakers.
Table	-6db ~ +2db	Adjusts the the intensity of the soundboard vibrations.
Back	-6db ~ +2db	Adjusts the amplification volume of the rear speakers box.

NOTE

These parameters are automatically saved in the memory Global area when the instrument is turned off.

Practicing with the Metronome

The metronome provide a steady tempo to aid practicing the piano at a consistent tempo.

- Press the [▲] button.

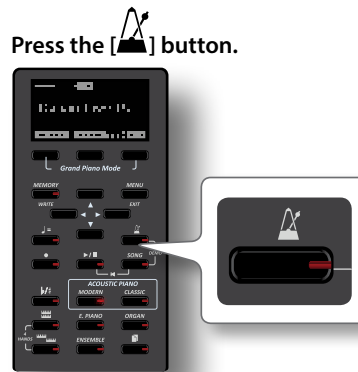

The [▲] button will blink, and the metronome will sound.

To change the Tempo value see "How to Adjust the Tempo Value" (p. 34).

- To stop the metronome, press the [▲] button once again.

The [▲] button indicator turn the lights off.

Metronome Settings

The VIVO H10 MG also allows you to specify when and how the metronome should sound:

- Press and hold the [▲] button until the display shown the following page.



The metronome settings can be also selected using [MENU] button →TEMPO→METRONOME.

- Use the [▲] [▼] buttons to select the parameter.
- Use the [◀] [▶] buttons to adjust the value.

The metronome parameters you can set are:

Parameter	Setting	Explanation
Volume	1~100	Sets the metronome's level.
Downbeat	OFF, ON	Select "ON" to activate the downbeat (the first beat of a measure in music) sound. Default: ON
Click		Specifies the metronome's resolution.

4. To mute the sound of Metronome press the "MUTE ON" Function button.

Press again to activate it again.

MEMO

The settings can be saved to the VIVO H10 MG's global memory.



The Tempo indication are the following:

Parameter	Setting	Assigned Tempo Value
Preset Tempo	GRAVE,	40
	LARGO,	45
	LARGHETTO,	49
	LENTO,	51
	ADAGIO,	57
	ANDANTE,	61
	ANDANTINO,	71
	MODERATO,	81
	ALLEGRO,	101
	ALLEGRETTO,	113
	VIVACE,	127
PRESTO,	145	
PRESTISSIMO	181	

How to Adjust the Tempo Value

You can modify the tempo of metronome.

MEMO

You can also use the TAP TEMPO function to set the desired tempo. See "Use Tap Tempo Function to set the Tempo Value" here below.

1. Press the [♪=] button.



The following page is shown:



The metronome settings can be also selected using [MENU] button →TEMPO→TEMPO_TAP.

2. Use the [◀] [▶] buttons to adjust the tempo value.

Parameter	Setting
♪=	20 ~ 300

3. In the same display page you can set the tempo using the Tempo indication. The tempo indication is typically written at the start of the score . Use the [▲] [▼] to select the tempo indication and use [◀] [▶] buttons to select a preset tempo.

Half and Double

4. Use the [HALF] or [DOUBLE] Function buttons to halve or double the tempo value.

Use Tap Tempo Function to set the Tempo Value

1. Press the [♪=] button at least three times at the desired tempo.

The instrument calculates the intervals between your presses and sets the corresponding tempo value.

Setting the Metronome Time Signature

The time signature is a notational convention to specify how many beats are to be contained in each bar and which note value is to be given one beat. In a musical score, the time signature appears at the beginning of the piece.

1. From the TEMPO/TAP page, use the [▲] [▼] and [◀] [▶] buttons to change the Time Signature value.



Parameter	Setting
Time Signature	2/2,
	2/4 ~ 15/4,
	2/8 ~ 15/8

MEMO

The settings can be saved to the VIVO H10 MG's global memory.

Adjusting the Keyboard Response (Key Touch)

If the keyboard response don't meet your taste, you can adjust it. You can choose until to four dynamic response.

1. Press [MENU/EXIT] button and select SETTING→KEYBOARD TOUCH function using the [▲], [▼] and [▶] buttons. See "Moving the cursor and setting parameter values" (p. 25).

The following page is shown.



2. Use the [◀] [▶] buttons to choose your desiderate dynamic response.

The following settings are available:

Setting	Value	Explanation	
Keyboard Touch	Light++, Light+, Light,	" Heavy ": range: Select this setting for maximum expressiveness. Even small variations of the force with which you strike a key produce audible changes. The trade-off is, however, that you have to strike the keys forcefully to reach the maximum volume.	
	Normal, Heavy,	" Normal ": Medium velocity sensitivity. The keyboard responds to velocity changes, but the maximum volume can be obtained more easily than with "Hard".	
	Heavy+, Heavy++,	" Light ": range: Select this settings if you are used to playing on an electronic organ or if you do not want velocity changes to bring about major volume changes.	
	Fixed [1~127]	" Fixed ": Select this setting if all notes you play on the keyboard should have the same velocity value. When you set this parameter, the "Fixed value" field can be edited.	
	*Fixed Value	1~127	Allows you to set the value when "Curve" is set to "Fixed".

[*] This parameter can only be edited if the "Keyboard Touch" parameter is set to "Fixed".

Customize the Global Keyboard Response (Key Touch)

We have previously seen how you can choose the keyboard response from 7 predefined curves: Heavy ++, Heavy+, Heavy, Normal, Light, Light+, Light++. Here below we will see how to modify the velocity curve as you wish, starting from one of the preset curves.

1. Press [MENU/EXIT] button and select SETTING→KEYBOARD TOUCH function. See "Moving the cursor and setting parameter values" (p. 25).

The following page is shown.



2. Use the [◀] [▶] buttons to choose your desiderate dynamic response.
3. To customize the velocity curve press the "VELOCITY" Function button.
4. Use the [◀] [▶] buttons to select one of the 5 points that characterize the curve: "pp", "p", "mf", "f", "ff".
5. Use the [▲] [▼] buttons to modify the value of the selected point.

Curve Point	Explanation
	"pp" standing for <i>pianissimo</i> and meaning "very soft".
	"p" standing for <i>piano</i> and meaning "soft".
	"mf" standing for <i>mezzo-forte</i> and meaning "half loud".
	"f" standing for <i>forte</i> and meaning "loud".
	"ff" standing for <i>fortissimo</i> and meaning "very loud".

6. Use the "RESET" Function button to restore the point at the default value.

NOTE

Your velocity curve is automatically saved in the global area when the instrument is turned off.

Master Equalizer

The equalizer give you the possibility to boosting or reducing the low-frequency or high-frequency range of the sound. Adjust the Master EQ parameters to reach the best possible sound when listening through different reproduction systems, headphones, or an external speaker system.

1. Press [MENU/EXIT] button and select EFFECTS→MASTER EQ



- Use the [▲], [▼] buttons to select the parameter and use the [◀] [▶] buttons to adjust the value.

Parameter	Setting	Explanation
High Gain	-12~ 0 +12 dB	Use this parameter to set the level of the high frequency. Positive values boost (increase) the volume of that frequency. Negative values cut (attenuate) it.
High Freq	400 ~ 10000 Hz	This parameter allows you to set the cutoff frequency of the high band.
Mid Freq	100 ~ 8000 Hz	This parameter allows you to set the cutoff frequency of the middle band.
Mid Gain	-12~ 0 +12 dB	Use this parameter to set the level of the selected MID frequency. Positive values boost (increase the volume of) that frequency. Negative values cut (attenuate) it.
Mid Q	0.5 ~ 12.0	Move this parameter to adjust the width of the area around the Middle frequency that will be affected by the Gain setting. Higher values of Mid Q set narrowest area
Low Gain	-12~ 0 +12 dB	Use this parameter to set the level of the low frequency. Positive values boost (increase) the volume of that frequency. Negative values cut (attenuate) it.
Low Freq	40 ~ 600 Hz	This parameter allows you to set the cutoff frequency of the low band.

Master Equalizer Preset

VIVO H10 MG comes with some Presets that can be handy in particular situations or a good way to get you started. You might want to start with a preset, then customize it until it is just right and save it in the user area.

- From the "MASTER EQ" page press the "PRESET" Function button.



- Use the [▲], [▼] buttons to select the desired preset.
- Press the "SELECT" Function button to confirm your choice.

Its "EQ" icon is highlighted to indicate that the preset has been loaded.

Saving Your User Preset

Make the necessary adjustments to obtain the sound that suits you best.

- From the "MASTER EQ" page, press the "SAVE" Function button.



- If you wish, you can give a name to the preset pressing the "RENAME" Function button. For details how to rename see "Assigning the Name You Specify" (p. 25).

- Press the "WRITE" Function button to save your preset. The display shows a confirmation message.

Restoring the Factory Settings (Factory Reset)

The following function allows you to recall the VIVO H10 MG's original factory settings.

WARNING

All data will be deleted. Backup your own settings to an USB memory.

- Press [MENU/EXIT] button and select FACTORY RESET function using the [▲], [▼] and [▶] buttons. See "Moving the cursor and setting parameter values" (p. 25).

The display shows the following window.

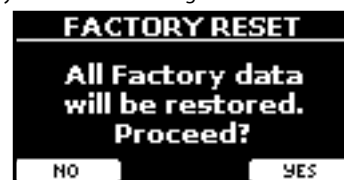

- Press the "YES" Function button proceed.

The message "Complete" informs you that the VIVO H10 MG has been initialized.

NOTE

The Factory Reset function initialize also the Global Area.

Restore the Factory Sounds

Using this function you can restore all sound libraries as they came out of the factory.

- Press [MENU/EXIT] button and select FACTORY SOUND function. See "Moving the cursor and setting parameter values" (p. 25).

The following page appears:

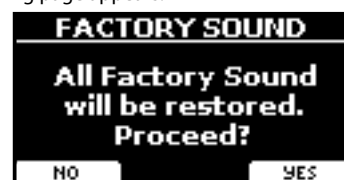

2. Press the "YES" Function button proceed.

The message "Complete" informs you that the VIVO H10 MG Sound Libraries has been restored.

If you no longer want to restore the sound libraries, press the "NO" Function button

How to Protect Your Settings, Contents and Sounds List (Backup)

You can back up contents, settings, and sounds list from your VIVO H10 MG into a USB Memory.

This function is also useful before sending your instrument for repair.

1. Press [MENU/EXIT] button and select the BACKUP function. See "Moving the cursor and setting parameter values" (p. 25).

The following page appears:



Backup Your Settings, Contents and Sounds List

1. Connect the USB Memory to which you wish to save your data. See "Connecting a USB Memory (commercially available)" (p. 21).

2. Select the "EXPORT BACKUP" function. See "Moving the cursor and setting parameter values" (p. 25).

The following page appears:



3. If you want to name your backup, see "Assigning the Name You Specify" (p. 25) for details.

4. Press the "OK" Function button to perform the function.

The following data are saved:

Backup Data
Global Parameters
Master Eq User Parameters
Memory Parameters
Memory Set Parameters
MIDI Set User Parameters
Temperament User Scale Parameters
Sound Library List
MIC Preset

Restore Your Settings, Contents and Sounds List

1. Connect the USB Memory that contains the data. See "Connecting a USB Memory (commercially available)" (p. 21).

2. Select the "IMPORT BACKUP" function. See "Moving the cursor and setting parameter values" (p. 25).

The contents of the USB memory are displayed:



3. Use the [▲][▼] to select the backup data you want.

4. Press the "IMPORT" Function button to perform the function.

The following page appears:



5. Press the "YES" function button to proceed. All data will be restored.

13 Additional Sound (Sound Library)

What is a Sound Library?

The sound (patch) in the DEXIBELL's devices is composed of several oscillators that reproduce waveforms. The patch contains also information about Pitch, TVA, TVF envelope, filters and so on. All this and more contributes to shapes the sound.

A Sound library contains sounds that use the same waveforms. For example, the "Electric Piano" library, contains the following sounds: Dyno Stage, Suitcase, Phaser EP, etc.

Sound Library Memory Structure

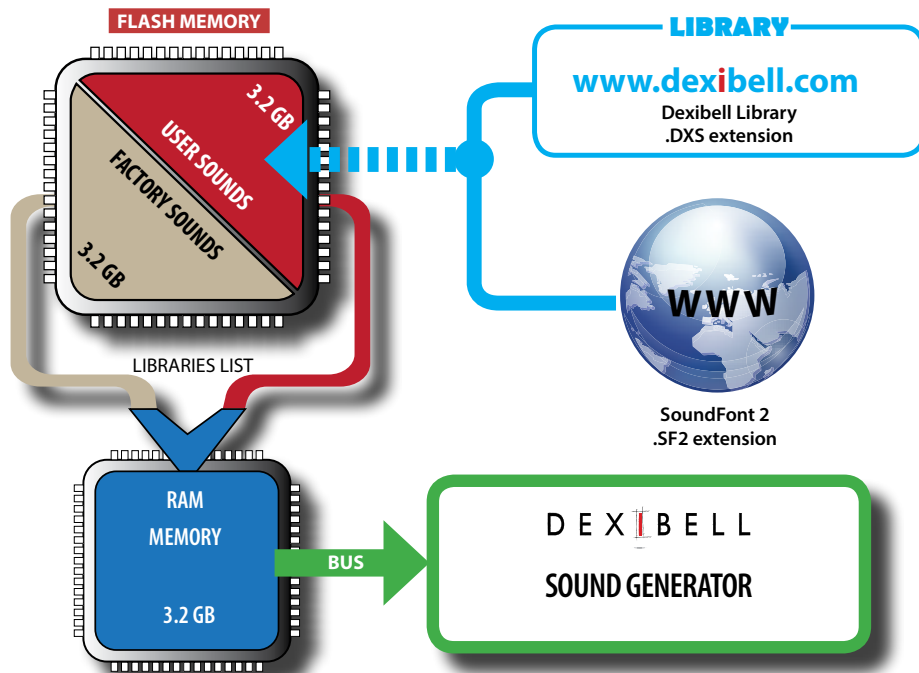

The VIVO H10 MG's Internal Flash Memory contains the Sound Libraries. This memory is divided into two parts of 3.2 GB:

- the first part, not erasable, contains the Factory Libraries.
- the second part, programmable, can contain the User Sound Libraries.

Using the list of libraries to load, at the power on, the VIVO H10 MG load the sound libraries from the Internal Flash Memory into the Internal RAM of 3.2 GB. At default, the list contains the Factory Libraries only.

You can load the new libraries into the User Sound area by taking them from the DEXIBELL library (www.dexibell.com) or from third-party sounds (.SF2 extension).

By a programmable list you can choose which sound libraries (User or Factory or part of them) to load in the RAM Internal Memory. You can decide to completely replace the factory sounds loading all sound from the User sounds area or decide to load a part of the sounds from the factory area and another from the User area.

Sound Library

VIVO H10 MG gives you the possibility to install new sounds from:

- DEXIBELL Official Sounds (.DXS extension)
These sounds will be available and downloadable from the following website:
<http://www.dexibell.com/>
Stay tuned for new sounds and updates by visiting our website regularly!
- third-party sounds (.SF2 extension)
You can easy found in the web many sounds library with .SF2 extension. VIVO H10 MG is compatible with these types of sounds.

Factory area ("INTERNAL ARCHIVE") ready to be reloaded again. See "Recovery a Library from the "INTERNAL ARCHIVE"" (p. 40) and "Restore the Factory Sounds" (p. 36).

1. Press [MENU/EXIT] button and select SOUND LIBRARY function pressing the [▶] button. See "Moving the cursor and setting parameter values" (p. 25).

A page like this appears:



The list of the Sound Libraries in the internal Memory are showed. You can note, at the left of each library name, a icons:

Icon	Explanation
	The library sound comes from the Factory Sound libraries.

Remove and Add Sound Libraries

In the "SOUND LIBRARY" page you can decide which libraries load into the RAM area.

NOTE

The removed libraries are not deleted. They remain in the

Icon	Explanation
	The library sound comes from the User Sound libraries.

At the bottom of the screen you can recall two functions: "REMOVE" and "ADD". Here below, we will explain how to remove or add sound libraries.

Removing a Sound Library



1. Use the [▲] [▼] buttons to select the sound library you want to temporary remove.
2. If you want to know the sounds contained in the library, press the [▶] button to open it.



3. If you want to listen the sounds of the library, use the [▲] [▼] buttons to select the sound and activate notes by the keyboard of the VIVO H10 MG.

If you don't need of these sounds, you can proceed with the removal.

4. From the "SOUND LIBRARY" page, press the "REMOVE" Function button to perform the removal.

The display shows:



5. Press the "YES" Function button to perform the removal. Press "NO" if you no longer want to perform the function.

NOTE ABOUT THE REMOVAL OF SOUND LIBRARIES

- **Factory libraries** - The factory libraries are not deleted but are removed from the list of libraries to load at startup.
- **User Sound libraries** . The User Sound libraries are permanently deleted. Make sure to have a backup, if you think you need them again.

How To Load Sound Libraries From a USB Memory

You can import sounds library in the User Sound memory of VIVO H10 MG and use them in your performances. To import them you need an USB Memory and your Personal computer.

Loading a sounds library from a USB Memory

1. Using your computer, download the new sound library from the DEXIBELL web site (.DXS) or from any other web site (.SF2).
2. Create a folder "SOUND" in the root of the USB Memory.
3. Copy the sound library (.DXS/.SF2) into the USB Memory's "/SOUND" folder.
4. Insert the USB Memory into the VIVO H10 MG USB port. See "Connecting an USB Memory (commercially available)" (p. 21).
5. See "Adding a Library from USB Memory" (p. 39) to import the sound library.

Adding a Library



1. Press the "ADD" Function button to add a library.

The display shows the libraries previous removed:



In the example above, the list of removed libraries is empty (no libraries has been previously deleted). In this case you can add only libraries from an USB Memory previously loaded.

The following example shows that some libraries was removed and the list of "INTERNAL ARCHIVE" shows which they are:



2. If you want get information about the RAM Internal free memory, press the "FREE SIZE" Function button.



The page shows the RAM Internal memory available express in MB and percent.

This function is useful to know how much available free memory you have to load new libraries.

Adding a Library from USB Memory

1. To load the library into your USB Memory, please refer to "Loading a sounds library from a USB Memory" (p. 39).

2. Insert the USB Memory into the USB port of the VIVO H10 MG.
3. From the "INTERNAL ARCHIVE" page, press the "USB" Function button to list the sound libraries in the USB Memory.

The following page is showed:



The instrument shows the sound libraries contained in the USB Memory's "\SOUND" folder.

MEMO

To navigate inside the folders use the [▶] button to open a folder and the [◀] button to return to a higher level.

Press the "INTERNAL" Function button to return to viewing the internal archive.

4. Use the [▲][▼] buttons to select the sound library you prefer.
5. To open the sound library, press the [▶] button.

The sound/sounds contained in the library are displayed.



6. Use the [▲][▼] buttons to select the sounds and listen them by the keyboard.

If the sounds are to your liking, you can import the library into the internal memory.

7. if you want to know the size of the library, press the "INFO" Function button.



8. Press the "IMPORT ALL" Function button to import the sound library.

The instrument asks you in which sound family you want to import the library:



9. Use the [▶][◀] buttons to select in which sound family you want to import the library.

10. Press the "EXECUTE" Function button to perform the function.

A confirmation message informs you that the sound library has been imported.

Recovery a Library from the "INTERNAL ARCHIVE"

Thanks to this function you can reload previously removed internal libraries.



1. Use the [▲][▼] buttons to select the library you want reload into internal memory.

2. To open the sound library, press the [▶] button.

The sound/sounds contained in the library are displayed.



3. Use the [▲][▼] buttons to select the sounds and listen them by the keyboard.

If the sound is to your liking, you can import the library into the internal memory.

4. if you want to know the size of the library, press the "INFO" Function button.



5. Press the "IMPORT ALL" Function button to import the sound library.

The instrument asks you in which sound family you want to import the library:



6. Use the [▶][◀] buttons to select in which sound family you want to import the library.

7. Press the "EXECUTE" Function button to perform the function.

A confirmation message informs you that the sound library has been imported.

How to Restore the Factory Sound

See "Remove and Add Sound Libraries" (p. 38).

14 Sound Setup (Export/Import)

This is a useful function that allows you to prepare a sound set for a performance. If, in a performance, you will use only piano sounds, you can create a Sound Set that contain only piano sounds. In this way you can use the maximum size of internal memory of the instrument for piano sounds.

At your convenience, you can also download sound sets from the <http://www.dexibell.com/> website.

Exporting a Sound Set ("EXPORT SETUP")

This function export the sound set, that you have previously prepared, in a USB Memory.

1. Prepare your Sound Set using the functions previously explained: "ADD" and "REMOVE". See "Remove and Add Sound Libraries" (p. 38).
2. Insert a USB Memory into the USB port of your instrument.
3. Press the [MENU/EXIT] button and use the [▲][▼] buttons to select the "SOUND SETUP" function group.



The "SOUND SET" page appears:



4. Use the [▲][▼] buttons to select "EXPORT SETUP" and press the [▶] button to access the function.

The display changes to:



5. If you want to name your Sound Set, please see "Assigning the Name You Specify" (p. 25).
6. Press the "OK" Function button to save your Set.

A confirmation message is temporarily showed.

Importing a Sound Set ("IMPORT SETUP")

This function import the sound set previously saved in a USB Memory.

NOTE

Before to import a Sound Set take in consideration that your current Sound Set, in the internal memory, will be replace.

You can lost external sound libraries previously loaded from a USB Memory. Regarding the internal sound libraries no problem, You can recover them in the "INTERNAL ARCHIVE". See "Adding a Library" (p. 39).

1. Insert a USB Memory that contains previously saved Sound Set into the USB port of your instrument.

2. Press the [MENU/EXIT] button and use the [▲][▼] buttons to select the "SOUND SETUP" function group.



The "SOUND SET" page appears:



3. Use the [▲][▼] buttons to select "IMPORT SETUP" and press the [▶] button to access the function.

The display shows the list of the Sound Set in the USB Memory:

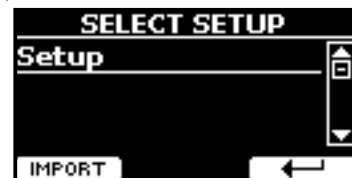

4. Use the [▲][▼] buttons to select the Sound Set.
5. Press the "IMPORT" F1 Function button to load the Sound Set.

A confirmation message is temporarily showed.

15 Personalizing Your Sounds (T2L)

T2L-Modelling



The revolutionary technology found on all models of DEXIBELL digital Pianos.

T2L-Modelling is the combination of innovative technologies developed to achieve maximum timbre accuracy and precise sound responsiveness to the multiple articulations of a pianist.

T2L modelling has many algorithms that simulate all the characteristics of an acoustic piano. It take care of many aspect as:

No Damper ("No Damper" on high notes)

The last 18 higher notes, like in the acoustic instrument, do not have the presence of the dampers and then are free to vibrate even when keys are released.

The duration of these notes, playing in staccato mode, is much longer than the previous notes that instead have the presence of the damper

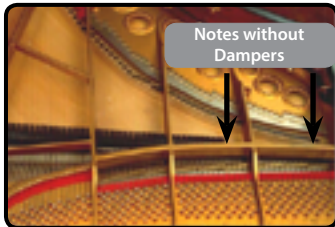

FP-Simulation ("Forte Pedal" multi actions simulation)

The "Forte" Pedal (Sustain), performs several actions that are simulated through this function.

- A) When the "Forte" pedal is pressed, a sound is generated to simulate the damper friction noises of felts when releasing from the strings (Damper Friction Noise).
- B) Pressing the "Forte" pedal, the active notes will be enriched with resonances produced by all strings free to vibrate, thanks to the raised dampers (Strings Resonance). The result of the Strings Resonance makes the sound of a sustained note by the use of the "Forte" pedal substantially different from the sound of a just held note.
- C) When the "Forte" pedal is released, a noise is simulated like the mechanical noise in the acoustic instrument (Sustain Pedal Mechanical Noise)



(A) & (B) "Forte" pedal is pressed, felt dampers are raised

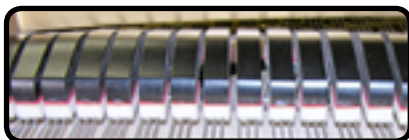

(C) "Forte" pedal is released, felt dampers are resting on strings

SP-Simulation ("Soft Pedal" Simulation)

The "Soft" Pedal, acts a change of volume and timbre color of the sound, simulating the "soft" function on the acoustic piano.



Soft Pedal

Making Slight Additions or Sound Alterations

Although DEXIBELL sound are developed to achieve the maximum sound accuracy, you can necessity to modify them at your taste them or create new sonority.

1. Select the sound that you want personalize.
2. From the main page press the "T2L" Function button to access the Editor function.

MEMO

You can also select this function pressing [MENU] button →T2L EDITOR.

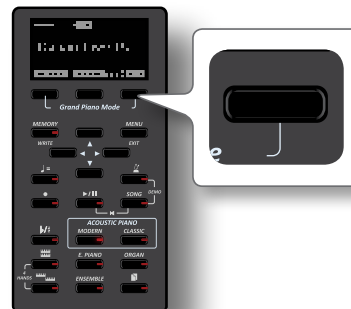

The display shows the Editor sound page that contains all possible parameters for the tone you selected:



In the example above the Italian Live Platinum was selected.

3. Use the [▲] [▼] buttons to select the parameter you wish to modify.
4. Use the [◀] [▶] buttons to adjust the value.
5. To modify a tone in the LOWER or COUPLED part press the relative Function button.

Saving your changing

All you need to do is to save your setting in a memory. See "Working with the Memories" (p. 53).

Parameters to be edited

The parameter list depends on the characteristics of the selected sound.

Hammer-Noises (Key On impulsive Noises)



Attack of notes contains an impulsive portion of sound produced by the hit of the Hammer to the strings, amplified and sustained by the resonance of the piano body. A function is available to reduce/increment this element of the sound.

Parameter	Setting
Hammer Noise	-64 ~ 0 ~ +63

Key Off Noise (Key Off Mechanical Noises)

The release of keys causes mechanical noises proportional to the speed of the release itself. This behavior of the acoustic instrument is reproduced by this function

Parameter	Setting
Key Off Noise	-64 ~ 0 ~ +63

Damper Noise

This is the typical noise of an acoustic piano when the pedal sustain is pressed (lift all dampers) or released (lower all dampers).

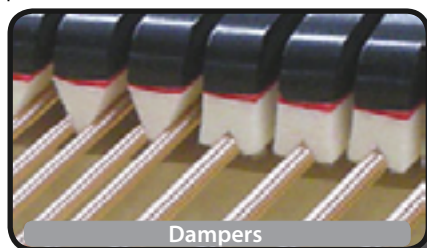

Parameter	Setting
Damper Noise	-64 ~ 0 ~ +63

String Reso (Sympathetic Harmonic Resonances)

As in the acoustic Piano, while holding down some keys and playing other notes in staccato mode, a multitude of additional harmonics can be listened, thanks to "sympathetic resonance" generated by the free to vibrate strings (due to raised dampers) of the held notes.

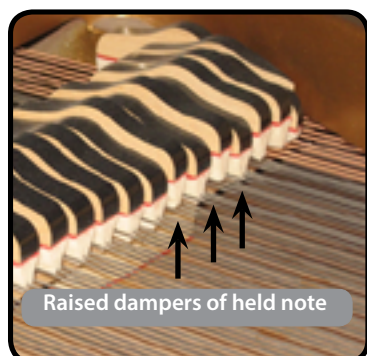

Parameter	Setting
String Reso	-64 ~ 0 ~ +63

Damper Reso

It's the typical noise generated by the free to vibrate strings (all damper raised) when the damper pedal is pressed.

Parameter	Setting
Damper Reso	-64 ~ 0 ~ +63

Cabinet Reso (for Wurly, Ac. Guitar, and Harp)

Thanks to this parameter you can increase or decrease the cabinet resonance.

Parameter	Setting
Cabinet Reso	-64 ~ 0 ~ +63

Bell (for Electric Piano)

The "bell sound" is characteristic of some electric pianos that became particularly popular throughout the 1970s.

You can adjust the quantity of this typical sound.

Parameter	Setting
Bell	-64 ~ 0 ~ +63

Click (for Vintage Organ)

The key click is typical of vintage organs. It's a electrical pop which was the result of the keys making contact. It was considered a defect, there were all kinds of efforts to reduce it, but it never could be eliminated. Meanwhile it has become a characteristic "click" for rock and modern musicians. You can adjust quantity of click sound when press and release a key.

Parameter	Setting
Click	-64 ~ 0 ~ +63

Growl (for Electric Piano)

This is a typical distortion of the sound during the phase attack that give a "growling" effect. Thank to this parameter you can increase or decrease the effect.

Parameter	Setting
Growl	-64 ~ 0 ~ +63

Off Noise (for Clavinet, Harpsy, Church Organ, E. Piano, Bass, Trumpet)

You can adjust the quantity of the noise effect that some instrument produce when the key is released.

Parameter	Setting
Off Noise	-64 ~ 0 ~ +63

On Noise (for Trumpet, Flugelhorn)

This parameter adjust the quantity of the noise of the trumpet when the piston is pressed.

Parameter	Setting
On Noise	-64 ~ 0 ~ +63

Attack, Hold, Decay, Sustain and Release (For Brass, Strings, Pad, Choir, Synth)

These parameters characterize the envelope of the sound. For example, when an organ key is pressed, it plays a note at constant volume; the sound dies quickly when the key is released. By contrast, the sound of a guitar is loudest immediately after a string is plucked, and quickly fades. Try to change the envelop of a sound by these parameters.

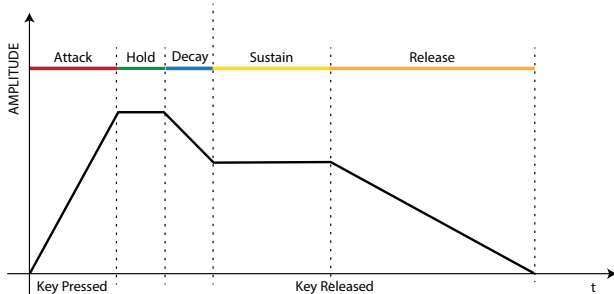

Parameter	Setting
Attack	
Hold	
Decay	-64 ~ 0 ~ +63
Sustain	
Release	

Ride

This parameter increase or decrease the volume of Ride Cymbals sound contained in the "Ac. Bass&Ride" tone.

Parameter	Setting
Ride	-64 ~ 0 ~ +63

Amp noise

This parameter simulates the noise of the bass amplifier.

Parameter	Setting
Amp noise	-64 ~ 0 ~ +63

String noise

This parameter simulates the resonance of the bass strings.

Parameter	Setting
String noise	-64 ~ 0 ~ +63

Key Noise

This parameter simulates the noise of Saxophone Key.

Parameter	Setting
Key noise	-64 ~ 0 ~ +63

Polyphonic

This parameter becomes useful when you use some solo instruments like flute, violin, saxophone, trumpet and accordion.

Parameter	Setting	Explanation
Polyphonic	Low, High, Last, Poly	<p>Low - The part becomes monophonic and play the leftmost note you played.</p> <p>High - The part becomes monophonic and play the rightmost note you played.</p> <p>Last - The part plays monophonic.</p> <p>Poly - The part plays polyphonic.</p>

Blow

Blowing is possibly the most important part of any woodwind instrument. This parameter adjusts the amount of blowing in a flute sound.

Parameter	Setting
Blow	-64 ~ 0 ~ +63

Pluck

This parameter is used to emphasize the sounds of "Pedal Bass" e "Pedal DoubleBs". It works to emphasize the attack phase of the sound.

Parameter	Setting
Pluck	-64 ~ 0 ~ +63

Adjusting the Keyboard Velocity Response According to the Sound

By the "Velocity Comand" function in the T2L MENU, you can adjust the keyboard velocity for each sound. You can choose to expand the velocity of a Piano sound and compress the velocity of a strings or Pad sound.

1. Access to the T2L EDITOR" function and select the keyboard part and the sound you want to edit. See "Making Slight Additions or Sound Alterations" (p. 42).
2. In the example below we selected the sound of the Main part. Use the [▲] [▼] buttons to move the cursor and select the "Velocity Comand" function.



3. Press the button [▶] to access the function. The following page appears:



4. Use the [▲] [▼] buttons to select one of the three parameters available.
5. Use the [◀] [▶] buttons to adjust the parameter you selected.

Adjusting the Keyboard Velocity Response According to the Sound

Parameter	Setting	Explanation
Start	0~127	It is the starting point of the velocity curve where you want to operate with the compression or expansion.
Rate	0.1~8.0	It is the compression/expansion coefficient that you want to use.
Offset	0~127	It's the minimum value of velocity.

In the example below you can see that the Start point was set to 52, the "Offset" starts from the value 35 and the rate was set to 2.7.

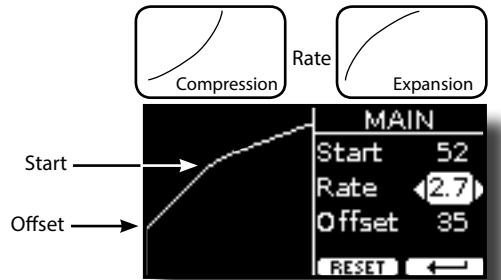

6. Press the "RESET" Function button to restore the parameters at the default value.

16 Using an Microphone (optional)

By plugging an optional microphone in the MIC socket, you can:

- Accompany yourself while you sing. See "Connecting an Optional Microphone" (p. 20).
- Add vocal effects such as reverb and delay, adjust the tone of your voice by a dedicate equalizer.
- Control the dinamic range of your voice using a dedicated compressor.
- Cut out lower frequencies of your voice by a Low Cut Filter.
- Easily select from six microphone settings already preset by the factory as "Standard", "Talk", etc, etc.
- Record your voice in high quality sound. See "Recording Your Performance" (p. 52)

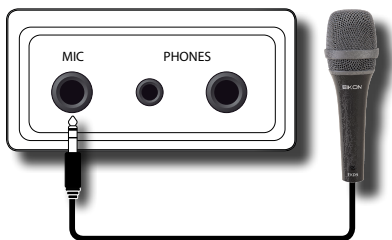

NOTE

Use only dynamic microphones.

Cautions when using a microphone

- Lower the volume before you connect a microphone to the VIVO H10 MG. If the volume is raised when you connect a microphone, noise may be output from the speakers.
- Howling could be produced depending on the location of microphone relative to speakers of your instrument or/and amplification system.

This can be remedied by:

- Changing the orientation of the microphone.
- If you use external speakers, relocating the microphone at a greater distance from them.
- Lowering volume levels.

Adjusting the Microphone Level and the Amount of Vocal Effects

1. Sing or talk into the microphone and gradually turn the "MIC LEVEL" knob to adjust the volume of your voice and balance it with the volume of the piano sound.

NOTE

If you don't hear anything, check the setting of the [VOLUME] knob.

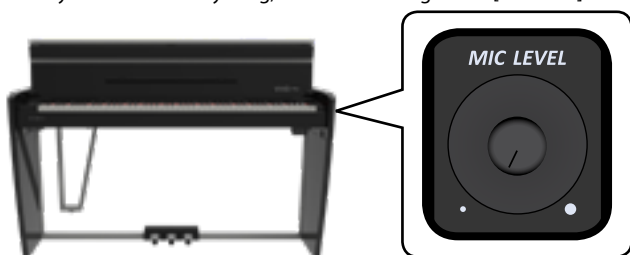

2. Use the "MIC EFFECT" knob to adjust the amount of vocal

effect (Reverb and Delay).

Turn it towards the right to increase the amount of the effect, and to the left to decrease the amount.

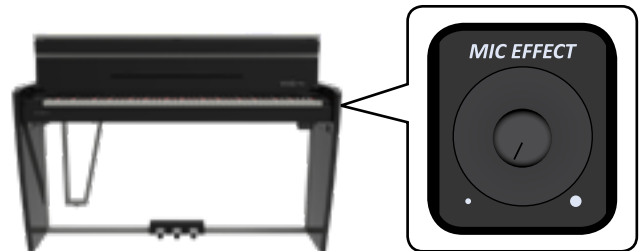

Microphone Preset

VIVO H10 MG has a series of settings that help you to adapt your voice for different situation. In additional, is possible adjust any MIC parameters as you like to create your personal preset and save it into the memory.

Selecting a MIC Preset

1. Press [MENU/EXIT] button and select the MICROPHONE function. See "Moving the cursor and setting parameter values" (p. 25).

The following page is shown.



2. Press the "PRESET" Function button to access to the "MIC PRESET" page.



3. Use the [▲], [▼] buttons to select the desired preset and press the "SELECT" Function button to recall it.

Saving Your MIC Preset

Create your setting by adjusting the various parameters of the equalizer, compressor, delay, reverb, etc etc., as you like.

From the main page of the "MICROPHONE":



1. Press the the "SAVE" Function button to access to the "SAVE MIC PRESET" page.



The list of presets is shown.

- Use the [▲], [▼] buttons to select the save location.

RENAME Your Preset

If you don't need to rename jump to "WRITE Your Preset".

- Press the "RENAME" Function button to rename your preset.



- Use the [▲][▼] and the [◀][▶] buttons to rename the your preset. See "Assigning the Name You Specify" (p. 25) for details.

- Press the "OK" Function button to confirm the name.
The preset is renamed and the list of the User presets is shown again.

WRITE Your Preset

- Press the "WRITE" Function button to save your preset.



The preset is saved and the list of the User presets is shown again.

Adding Dedicate Vocal Effects

Take advantage of the VIVO H10 MG's voice effects to enhance your vocal.

REVERB EFFECT

What is the Reverb effect? When you make a sound in any room or outdoors, the sound waves travel around that space, bouncing off the walls before returning back to your ears as a series of delayed echoes. This effect gives depth to the sound adding a near-far dimension. Reverb and Delay are the most widely used effects.

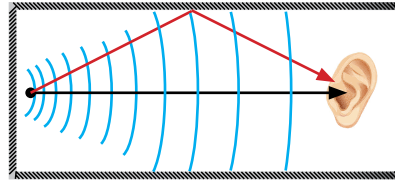

VIVO H10 MG gives you the ability to control this effect through many preset (macro) and parameters as the size of the room, the level, etc, etc.

DELAY EFFECT

What is the Delay effect? It's the results of the reflection of the sound similar to the reverb but works on the big spaces as canyon or inside a gigantic room. Delay is also called echo.

You can control this effect by many preset (macro) and parameters as the time of the delay, the level, etc, etc.

Reverb Effect

- Press [MENU/EXIT] button and select MICROPHONE→Reverb function. See "Moving the cursor and setting parameter values" (p. 25).

The following page is shown.



- Use the [▲], [▼] buttons to select the parameter and use the [◀][▶] buttons to adjust the value.
- Use the "ON OFF" Function button to enable or disable the reverb effect.

Parameter	Setting	Explanation
Macro	Hall, Mid Hall, Concert Hall, Large Hall, Cathedral, Chamber, Venue, Ambience, WoodenRoom, Brick Room, Studio Booth, Plate, Bright Spring, AmpSpring	This parameter allows you to select one of the preset reverb types.
Level	0 ~ 127	Set the quantity of Reverb effect.
Damp	0 ~ 127	Adjusts the amount of damping of the room
RoomSize	0 ~ 127	It determines the size of the simulated room.
Width	0 ~ 127	Adjusts the stereo width of the Reverb effect.

Parameter	Setting	Explanation
Predelay	0 ~ 127 ms	Adjusts the delay from the direct signal and the moment when the reverb starts working. This is used to simulate the distance between the original signal and the reflective surfaces

MEMO

If you want to use these settings again at a later stage, consider saving them in a MIC preset. See "Saving Your MIC Preset" (p. 46).

Delay Effect

1. Press [MENU/EXIT] button and select MICROPHONE→Delay function. See "Moving the cursor and setting parameter values" (p. 25).

The following page is shown.



2. Use the [▲], [▼] buttons to select the parameter and use the [◀] [▶] buttons to adjust the value.
3. Use the "ON OFF" Function button to enable or disable the delay effect.

Parameter	Setting	Explanation
Macro	Voice 1, Voice 2, Voice 3, Voice 4, Echo1, Echo 2	This parameter allows you to select one of the preset delay types.
Level	0 ~ 127	Set the quantity of delay effect.
Time	0 ~ 1000 ms	Sets the delay time.
Feedback	-96% ~ +96%	Adjusts the proportion of the delay sound that is fed back into the effect. Negative (-) settings will invert the phase.

MEMO

If you want to use these settings again at a later stage, consider saving them in a MIC preset. See "Saving Your MIC Preset" (p. 46).

Setting the Microphone Equalizer

What is a Equalizer?

An equalizer (EQ) consists of a series of audio filters that adjust the amplitude of audio signals at particular frequencies. You can use this equalizer adjust the tone of your voice.

1. Press [MENU/EXIT] button and select MICROPHONE→Equalizer function. See "Moving the cursor and setting parameter values" (p. 25).

The following page is shown.



2. Use the [▲], [▼] buttons to select the parameter and use the [◀] [▶] buttons to adjust the value.
3. Use the "ON OFF" Function button to enable or disable the equalizer.

Parameter	Setting	Explanation
Low Freq	40Hz, 60Hz, 80Hz, 100Hz, 120Hz, 150Hz, 200Hz, 250Hz, 300Hz, 400Hz, 500Hz, 600Hz	This parameter allows you to set the cutoff frequency of the low band.
Low Gain	-12~ 0 +12 dB	Use this parameter to set the level of the low frequency. Positive values boost (increase) the volume of that frequency. Negative values cut (attenuate) it.
Mid Freq	100Hz, 150Hz, 200Hz, 250Hz, 300Hz, 350Hz, 400Hz, 450Hz, 500Hz, 550Hz, 600Hz, 650Hz, 700Hz, 750Hz, 800Hz, 850Hz, 900Hz 950Hz, 1KHz, 1.5KHz, 2KHz, 3KHz, 4KHz, 5KHz, 6KHz, 7KHz, 8KHz	This parameter allows you to set the cutoff frequency of the middle band.
Mid Gain	-12~ 0 +12 dB	Use this parameter to set the level of the selected MID frequency. Positive values boost (increase the volume of) that frequency. Negative values cut (attenuate) it.
High Freq	400Hz, 600Hz, 800Hz, 1KHz, 1.5KHz, 2KHz, 3KHz, 4KHz, 5KHz, 6KHz, 7KHz, 8KHz, 10KHz	This parameter allows you to set the cutoff frequency of the high band.
High Gain	-12~ 0 +12 dB	Use this parameter to set the level of the selected high frequency. Positive values boost (increase the volume of) that frequency. Negative values cut (attenuate) it.
Mid Q	0.5 ~ 12	Move this parameter to adjust the width of the area around the Middle frequency that will be affected by the Gain setting. Higher values of Mid Q set narrowest area.

MEMO

If you want to use these settings again at a later stage, consider saving them in a MIC preset. See "Saving Your MIC Preset" (p. 46).

Setting the Microphone Compressor

What is a Compressor?

A compressor reduces the dynamic range of an audio track by lowering the volume level of the loudest parts. This will result in an audio track that has fewer variations in volume. The audio compression is a must specially for the voice recording. It evens out the erratic levels that a singer can produce and it lower transients that can cause digital distortion.

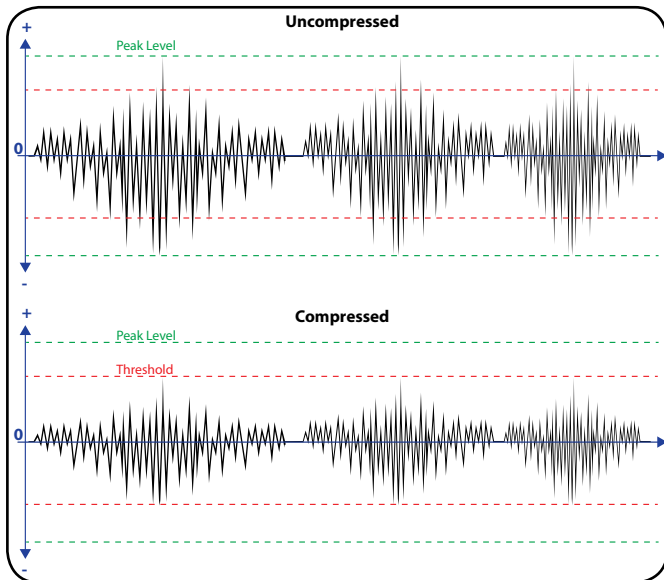

1. Press [MENU/EXIT] button and select MICROPHONE→Compressor function. See "Moving the cursor and setting parameter values" (p. 25).

The following page is shown.



2. Use the [▲], [▼] buttons to select the parameter and use the [◀] [▶] buttons to adjust the value.
3. Use the "ON OFF" Function button to enable or disable the compressor.

Parameter	Setting	Explanation
Threshold	-40 ~ 0 dB	Adjusts the volume at which compression begins.
Ratio	1:1, 1.2:1, 1.4:1, 1.6:1, 1.8:1, 2:1, 3:1, 4:1, 5:1, 6:1, 7:1, 8:1, 9:1, 10:1, 11:1, 12:1, INF:1	The ratio parameter tells how much to compress once the signal has surpassed the threshold value. 1:1 means no compression. For example 2:1 means that for every 2 dB of volume that shoots over the threshold, only 1 dB is allowed to sound out. INF:1 means that any signal does not exceed the amplitude of the threshold.

Parameter	Setting	Explanation
Knee Width	0.0 ~ 1.0	The "knee" parameter refers to how the compressor transitions between the non-compressed and compressed states of an audio signal. Transition hard (0.0) or soft (1.0).
Attack Time	0 ~ 250 ms	The "Attack Time" is the time that the audio processor takes for the signal to become fully compressed after exceeding the threshold level.
Release Time	0 ~ 1000 ms	The "Release Time" refers to how long the compressor will take to relax the compression once the signal has fallen below the threshold.
Gain	-24 ~ +24 dB	Increase or decrease the volume of the compressed signal.

MEMO

If you want to use these settings again at a later stage, consider saving them in a MIC preset. See "Saving Your MIC Preset" (p. 46).

Setting the Low Cut Filter

What is a Low Cut Filter?

Also known as a high pass filter, it's a filter that allows to cut low-frequency signal usually from 40 to 300 Hz. These frequencies are often the same ones associated with ambient room noise.

1. Press [MENU/EXIT] button and select MICROPHONE→Low Cut Filter function. See "Moving the cursor and setting parameter values" (p. 25).

The following page is shown.

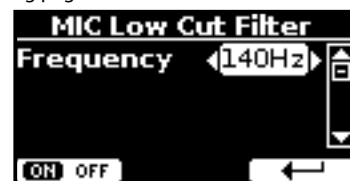

2. Use the [◀] [▶] buttons to adjust the value.
3. Use the "ON OFF" Function button to enable or disable the filtering.

Parameter	Setting	Explanation
Frequency	40Hz, 60Hz, 80Hz, 100Hz, 120Hz, 140Hz, 160Hz, 180Hz, 200Hz, 220Hz, 240Hz, 260Hz, 280Hz, 300Hz	Use this parameter to set the cut frequency.

MEMO

If you want to use these settings again at a later stage, consider saving them in a MIC preset. See "Saving Your MIC Preset" (p. 46).

17 Practice with Song Player

This section explains how to playback audio songs stored in the internal memory or in the USB Memory (commercially available).

You can practice playing along backing song.

VIVO H10 MG play back the following file types:

File Type	Extension
Audio files	.mp3
	.wav
	.aiff or .aif



The display shows the Song main page and the name of the current song is shown if already loaded.

Playing a Song

Loading a Song From Internal Memory

1. Press the [SONG] button. Its indicator lights.

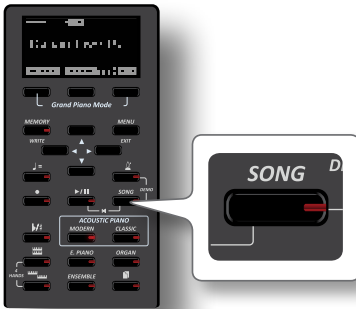

The display shows the Song main page and the name of the current song is shown if already loaded.



2. Press the "SONG LIST" function button. The display shows the contents of the Song internal memory.



3. Use the [▲][▼] buttons to scroll through the files to choose the song to load.
4. Press the "SELECT" Function button to load the song you want to practice.

Loading a Song From USB Memory

1. Insert an USB Memory that contains songs. See "Connecting an USB Memory (commercially available)" (p. 21).

2. Press the "SONG LIST" function button. The display shows the contents of the Song internal memory.



3. To list the USB Memory contents, press the "USB" Function button.

The display shows the contents of the USB Memory.



4. Use the [▲][▼] buttons to scroll through files and folders.
5. If the song you need is located inside a folder, you must first select that folder, press the "OPEN" Function button to see its contents and then select the song. If you opened a folder by mistake, press the "←" Function button to return to a higher level.
6. Press the "SELECT" Function button to load the song you want to practice. The song icon is highlighted to indicate the song selected.

Playing the loaded song

1. Press the [▶/||] button.
The [▶/||] button's indicator lights and song playback starts..
2. Press the [▶/||] button again to pause song playback.
The [▶/||] button goes dark.
3. To return to the beginning of the song, simultaneously press the [▶/||] and [SONG] buttons

4. Press [▶/||] yet again to resume playback.

Useful Song Controls

VIVO H10 MG has useful song controls that allow you to adjust the volume, rewind or fast-forward within the currently selected song, etc.

1. Load the song you want to play back. See "Playing a Song" (p. 50).



2. From the Song main page, press the "CONTROL" Function button.

The display shows:



3. Use the [▲][▼] buttons select the control parameter.
4. Use the [◀][▶] buttons to choose your setting.

Parameter	Value	Explanation
Volume	0~127	Adjust the Volume of the song player
Time	It depends on the duration of the song	<ul style="list-style-type: none"> • Press the [◀] to rewind within the song • Press the [▶] to fast-forward within the song
Loop Mode	OFF, SONG, LIST	<p>"OFF": No loops. Playback stops at the end of the current selected song.</p> <p>"SONG": Continuously repeats playback of the current selected song. Playback repeats until you select a different song or stop playing the song.</p> <p>"LIST": Continuously repeats playback of all music files available in a folder, in consecutive order. Playback repeats until you select a different song or stop playback.</p>

18 Recording Your Performance

Your digital piano allows you to record your performance and save it internally or to an USB storage device.

Record and play back what you've played on the instrument can be an effective practice aid.

Recording as Audio Data

Your performance will be recorded as audio data. The recorded song can be used on your computer, phone and in any audio player.

NOTE

To use this method of recording, you must connect a USB drive (sold separately) to the USB Memory port (p. 21).

memory.

NOTE

Do not disconnect the USB Memory during the song recording or before the confirmation message is shown at the end of recording.

About the Recording Files

The audio file are saved in the "Recording" folder on the USB Memory.

If the "Recording" folder doesn't exist, it is automatically created at the first recording.

The song are saved with a different progressive number: rec_0001.wav, rec_0002.wav and so on.

Recording Your Music as audio data (WAVE).

This useful function allows professional quality stereo recordings. If a microphone is connected to the MIC socket, you can add your voice to the recording.

You can reproduce directly by a portable music players by using a computer.

Recording are saved in the external USB Memory (commercially available).

In addition, the VIVO H10 MG digital piano allows you to record audio from a bluetooth device. See "Wireless Function" (p. 59).

NOTE

- You will need a USB Memory (commercially available) to record your performance.

Audio Recorder format specifications

Audio Format	Specification
WAV	48 kHz, 32 bit, Stereo

Before you start recording

1. Connect the USB Memory to which you wish to save the audio data. See "Connecting an USB Memory (commercially available)" (p. 21).
2. Prepare everything you want to record: select the tone and the keyboard mode that you want to use for performing. See "Selecting Tones" (p. 26).
3. If desired, sound the metronome. See "Practicing with the Metronome" (p. 33).

MEMO

The metronome signal is not recorded.

Starting/stopping recording

4. Press the [●] (Rec) button to start recording.
The indicator of the [●] button lights and the VIVO H10 MG starts to recording everything you play on the keyboard.
5. At the end of the song, press the [●] (Rec) button to stop recording.
The recording stop and the display shows a confirmation message. Your audio file is saved to the "Recording" folder on the USB

Listening to your recording

6. Press the [▶/||] button to listen your song.

If you want to re-record again, repeat from step 4.

NOTE

You should always safely eject the USB Memory before physically unplugging it from USB socket. Before to unplug the USB Memory use the "USB REMOVE" function. See "Safely Remove the USB Memory" (p. 22).

How to Record your Performance over an Existing Audio Base (Overdub)

This is a technique used in audio recording. While listening to an existing recorded audio base, play a new performance along with it. All is recorded in a new song.

1. Connect the USB Memory to which you wish to save the audio data. See "Connecting an USB Memory (commercially available)" (p. 21).
2. Prepare everything you want to record: select the tone and the keyboard mode that you want to use for performing. See "Selecting Tones" (p. 26).
3. Load a existing audio base. See "Loading a Song From Internal Memory" (p. 50).
4. Press the [●] (Rec) button to start recording.
5. Press the [▶/||] button to start the playback of the audio base as background.
6. Play your performance while listen the audio base.
7. At the end of song, press the [●] (Rec) button to stop recording.
The recording stop and the display shows a confirmation message.
8. Press the [▶/||] button to listen your song.

19 Working with the Memories

Using the Memories is a lot faster than calling up one of the VIVO H10 MG's functions, modifying the settings, etc., while playing.

VIVO H10 MG provides 80 Memories that allow you to store almost all settings (or registrations) you make on the front panel and the various display pages. Additional Memories can be imported directly from a USB Memory.

About the Memories and Memory Set structure.

The Memories you create are saved in the internal Memory Set or in an external Memory Set previously saved in the USB Memory. This allows you to prepare one set of Memories for weddings, another for corporate events, a third for anniversaries, etc.

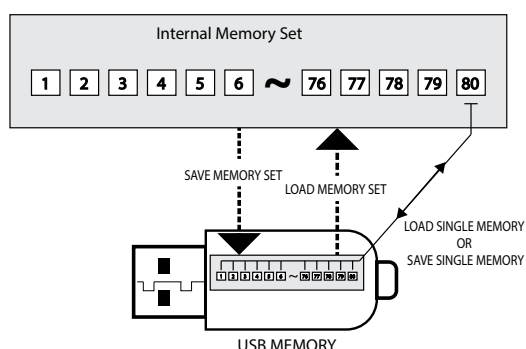

Saving Your Settings in the Internal Memory

1. Change all settings the way you want to save them.
For details on settings memorized, see p. 62.
2. Press and hold the [MEMORY/WRITE] button until the display shows:



The [MEMORY/WRITE] button indicator flashes and the list of Internal Memory is shown.

MEMO

You can also select this function pressing [MENU] button →MEMORY→WRITE.

3. Use the [▲][▼] buttons to move the cursor inside the list in the position you want to replace the Memory.
4. Press the "SAVE" Function button to confirm.
The display changes to:



5. If you want to name your new Memory, see "Assigning the Name You Specify" (p. 25) for details.
6. Press the "OK" Function button to save the Memory.
The memory will be saved and the list of Internal Memory is shown.



Recalling your Settings from Internal Memory

1. Press the [MEMORY/WRITE] button.
The [MEMORY/WRITE] button indicator lights steady and the list of Internal Memory is shown.



MEMO

You can also select this function pressing [MENU] button →MEMORY→RECALL.

2. Use the [▲][▼] buttons to move the cursor inside the list to select the Memory you want to recall.
3. Press the "RECALL" Function button to recall the Memory.
The Memory is recalled and the display shows the Memory highlighted.



Saving Your Settings in the USB Memory (commercially available)

1. Connect the USB Memory to which you wish to save the Memory. See "Connecting an USB Memory (commercially available)" (p. 21).
2. Change all settings the way you want to save them.
3. Press and hold the [MEMORY/WRITE] button until the display shows:



The list of Internal Memory is shown.

MEMO

You can also select this function pressing [MENU] button →MEMORY→WRITE.

- Press the [USB] Function button to select the destination memory.

The display shows a list of all files and folders on the USB storage device you have just connected.



Now you can save:

- In a Memory Set previously saved. Continue from step (5)
- In a new Memory Set. See "Saving in the New Memory Set" below.

Saving in the Memory Set previously saved

- Use the [▲][▼] buttons to scroll through files and folders to select the Memory Set.

Memory Set Icon	Memory Set file extension
	.rif

Use the "OPEN" Function button if you need to enter in a folder. If you opened a folder by mistake, press the [←] button to return to a higher level.

- Press the "OPEN" Function button to recall the Memory Set.

The display shows the list of memories in the Memory Set.



- Use the [▲][▼] buttons to move the cursor inside the list in the position you want to replace the Memory.

- Press the "SAVE" Function button to confirm.

The display changes to:



- If you want to name your new Memory, see "Assigning the Name You Specify" (p. 25) for details.

- Press the "OK" Function button to save the Memory. The memory will be saved and the list of memories is shown.



Saving in the New Memory Set

- Press the "NEW SET" Function button to create an empty Memory Set.

This page allows you to create a new Memory Set List whose name is selected automatically by the VIVO H10 MG.



- If you want to name your new Memory Set, see "Assigning the Name You Specify" (p. 25) for details.

- Press the "OK" Function button to confirm the name.

The display shows contents of the new Set just created.



- Use the [▲][▼] buttons to move the cursor inside the list in the position you want to write the Memory.

- Press the "SAVE" Function to confirm.

The display changes to:



A Memory name is suggested by the VIVO H10 MG.

- If you want to name your new Memory, see "Assigning the Name You Specify" (p. 25) for details.

- Press the "OK" Function button to save the Memory.

The memory will be saved and the list of Memories is shown.



Recalling your settings from an USB Memory

1. Connect an USB memory to the VIVO H10 MG. For details see p. 21.

A USB icon appears in the Icons field of Main page. See "Main Page" (p. 24).

2. Press the [MEMORY/WRITE] button.

The [MEMORY/WRITE] button indicator lights steady and the list of Internal Memory is shown.



MEMO

You can also select this function pressing [MENU] button →MEMORY→RECALL.

3. Press the "USB" Function button.

The display shows a list of all files and folders on the USB storage device you have just connected.



4. Use the [▲][▼] buttons to scroll through files and folders to select the Memory Set.

Memory Set Icon	Memory Set file extension
	.rif

Use the "OPEN" Function Button to enter in a folder.
If you opened a folder by mistake, press the [←] button to return to a higher level.

5. Press the "OPEN" Function button to open the selected Memory Set.

The display shows the list of Memories:



6. Use the [▲][▼] buttons to move the cursor inside the list to select the Memory you want to recall.

7. Press the "RECALL" Function button to recall the Memory.

The Memory is recalled and the display shows the Memory highlighted.



MEMO

To display the Internal Memories again, press the "INTERNAL" Function button.

Renaming a Memory

This function allows you to change the name of a selected Memory.

1. Press the [MENU] button and select MEMORY→RENAME.

The list of Internal Memory is shown:



2. Use the [▲][▼] buttons to move the cursor inside the list in the position you want to rename the Memory.

3. Press the "RENAME" Function button to confirm.

The display changes to:



4. Use the [▲][▼] and the [←][→] buttons to rename the Memory. See "Assigning the Name You Specify" (p. 25) for details.

5. Press the "OK" Function button to confirm the name.

The memory will be renamed and the list of Internal Memory is shown.



Exporting a Memory Set in the USB Memory

Use this function for exporting the Internal Memory Set in the USB Memory (commercially available).

This function is useful to create special sets for each event and import them at your convenience.

You can also use this function to backup the Internal Memories.

1. Connect an USB memory to the VIVO H10 MG. For details see p. 21.

A USB icon appears in the Icons field of Main page. See "Main Page" (p. 24).

- Press the [MENU] button and select MEMORY→EXPORT SET.



The display shows a list of all files and folders on the USB storage device you have just connected.



- Use the [▲][▼] buttons to scroll through folders to select the destination folder.

Use the "OPEN" Function button to enter in a folder.

If you opened a folder by mistake, press the [←] button to return to a higher level.

- Press the "EXPORT" Function button to confirm your selection.

The display changes to:



A Memory Set name is suggested by the VIVO H10 MG.

- If you want to name the Memory Set, see "Assigning the Name You Specify" (p. 25) for details.
- Press the "OK" Function button to export the Memory Set.

A message confirm the operation.

NOTE

You should always safely eject the USB Memory before physically unplugging it from USB socket. Before to unplug the USB Memory use the "USB REMOVE" function. See "Safely Remove the USB Memory" (p. 22).

Importing a Memory Set from the USB Memory.

Use this function for importing Sets from the USB Memory (commercially available) to Internal Memory.

- Connect an USB memory that contains Memory Sets to the VIVO H10 MG. For details see p. 21.

A USB icon appears in the Icons field of Main page. See "Main Page" (p. 24).

- Press the [MENU] button and select MEMORY→IMPORT SET.

The display shows a list of all files and folders on the USB storage device you have just connected.



- Use the [▲][▼] buttons to scroll through folders to select the Memory Set to import.



Use the "OPEN" Function button to enter in a folder.

If you opened a folder by mistake, press the [←] button to return to a higher level.

- Press the "IMPORT" Function button to confirm your selection.

A message confirm that the Memory Set was imported.

NOTE

You should always safely eject the USB Memory before physically unplugging it from USB socket. Before to unplug the USB Memory use the "USB REMOVE" function. See "Safely Remove the USB Memory" (p. 22).

How to Automatically Recall Your Favorite Setting at the Power On.

The VIVO H10 MG give you the possibility to have your favorite setting directly at the startup of the instrument. To do this, follow the procedure below:

- Set all the parameters you want when you turn on the instrument.
- Press the [MENU] button and select MEMORY→SAVE AS DEFAULT.



The instrument asks you if you want your settings as default.



- Press the "Yes" Function button to confirm the operation. Press "No" to quit the function.

How to Customize the Grand Piano Mode

As seen in the "Selecting Tones" chapter, we can easy recall the best piano sound pressing simultaneously the first and last Function button from the

Main page. See "Grand Piano Mode" (p. 26).

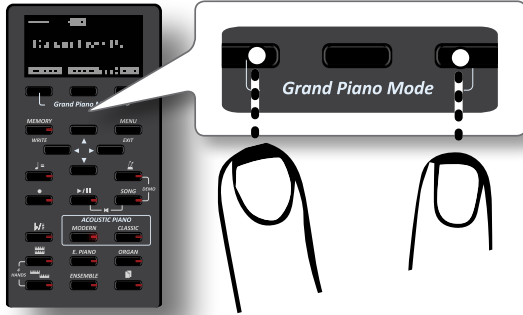

Through the "SAVE AS G.P. MODE" function we can save our own setting and recall it when entering the "Grand Piano Mode".

1. Modify the sound and all the parameters you want for the "Grand Piano Mode".
2. Press the [MENU] button and select MEMORY → SAVE AS G.P. MODE.

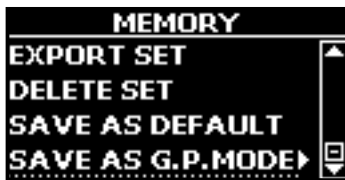

The instrument asks you if you want to save your "Grand Piano Mode".



3. Press the "Yes" Function button to confirm the operation. Press "No" to quit the function.

20 Playing with Audio Backing Tracks

Thanks to X MURE® application and VIVO H10 MG you can play your favourite melodies while controlling a audio pattern.



X MURE® is a DEXIBELL® software product

WHAT IS X MURE

- X-MURE is an application that runs on iPhone or iPad.
- Using "Harmony Poly Fragmentor" the world first algorithm able to modify "audio tracks" in real time, "X MURE" allows you to play music directly on the screen of your iPad/iPhone or with a musical instrument connected via USB.
- "X MURE" does not use sound generators, virtual instruments or "Standard MIDI file", it is exclusively based on audio tracks recorded by real musical instruments, so it does not simulates reality... it is the reality.

WHAT YOU CAN DO WITH X MURE

- Control X MURE audio patterns by live chord progression played by VIVO H10 MG.
- Re--arrange your favourite music tracks using countless musical genres or create a completely new song hit.

WHAT YOU NEED TO USE X MURE

- VIVO H10 MG Digital Piano.
- Apple iPad Camera Connection Kit (Camera connectors made by Apple Inc.).
- USB cable (type A--male - type B--male: commercially available).
- Download X MURE application from App Store.

2. Rotate the [VOLUME] knob toward the lower position to minimize the volume.

Playing with X MURE Application

1. Turn your VIVO H10 MG and your iPad on.
2. Touch the X MURE icon in your iPad to open the app.

Now you have three possible choices:



3. Touch Dexibell VIVO icon to have the maximum performance with VIVO H10 MG.

The following page appears:



4. Play a note in the keyboard to inform X MURE which part you want use to control it.
5. On X MURE select the audio pattern you want play back.
6. Touch the play icon of the X MURE application. The pattern start to play back.

MEMO

You can use a pedal to Play or Stop the play back of the pattern. See "CENTRAL PEDAL" or "LEFT PEDAL" (p. 65).

7. Play chords in the keyboard. The audio pattern follows your chord progression.
8. On X MURE touch the "A", "B", "C", "D" icon button to chose a different scene.

MEMO

You can use a pedal to select different scene. See "CENTRAL PEDAL" or "LEFT PEDAL" (p. 65).

9. On X MURE touch the "1", "2", "3", "4" icon button to chose a different drum pattern.

MEMO

You can use a pedal to select different drum pattern. See "CENTRAL PEDAL" or "LEFT PEDAL" (p. 65).

Connecting your Mobile Device

1. Connect your iPad with your VIVO H10 MG by using a USB iPad camera connector and a USB cable.

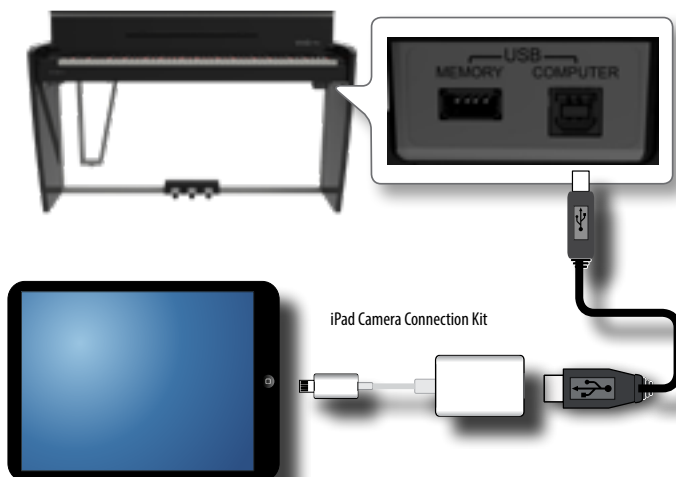

21 Wireless Function

Bluetooth® Audio and MIDI Connectivity

VIVO H10 MG Pianos are equipped with Audio and MIDI Bluetooth® (4.2 Low Energy) function.

Thanks to this technology, you'll be able to :

- listen through the speakers of the VIVO H10 MG the music played back by smartphone, tablet.
- exchange MIDI data between the mobile device and the VIVO H10 MG.

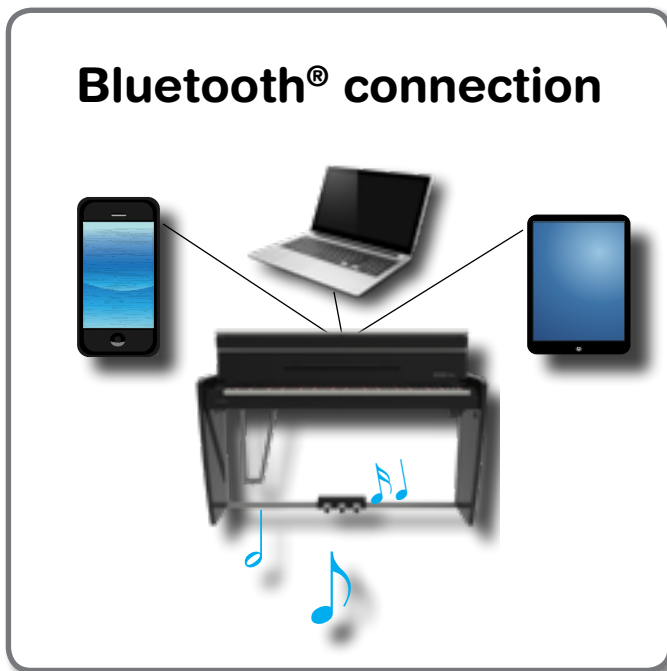

Turning on the VIVO H10 MG's Bluetooth Function

1. press the [MENU] button and select Bluetooth® page.



2. Use the [▲][▼] buttons to select the "Visible" parameter.
3. Use the [◀][▶] buttons to set it "On".

The VIVO H10 MG is now visible to other devices:

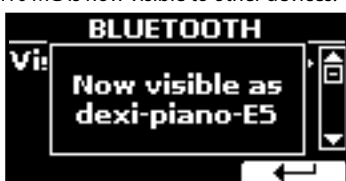

The first time you use a new mobile device, you need to "pair" it with your device so that both devices know how to connect securely to each other.

Connecting with the Mobile Device



NOTE

Please take in consideration that the explanation to pair your mobile device with the VIVO H10 MG is as an example. The operations to pair your mobile device can be different from our explanation and depend on the operating system of your device. For details, please refer to the owner's manual of your mobile device.

1. Place the mobile device within 1 meter (3 ft) from VIVO H10 MG.

NOTE

When pairing, make sure that other devices are off or out of range.

2. Make sure that VIVO H10 MG is visible to other devices. See "Turning on the VIVO H10 MG's Bluetooth Function" (p. 59).
3. On the mobile device that you want to connect, turn on the Bluetooth® function and, if necessary, search for the available devices.

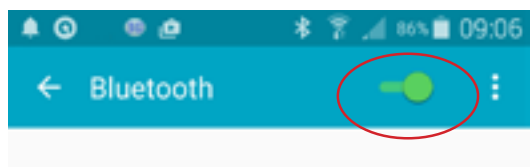

For details on how to enable the Bluetooth® function, refer to the owner's manual of your mobile device.

The list of available devices is now shown in your mobile device.

4. Select the "dexi-piano-xx" device that is shown in the Bluetooth® list of your mobile device.

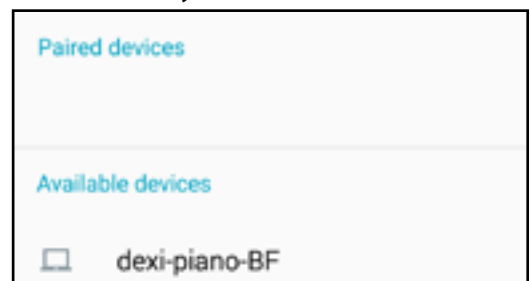

In example above the device name is "dexi-piano-BF".

5. If the mobile device and the VIVO H10 MG ask you to confirm the connection showing the "passkey" screen, confirm before on VIVO H10 MG and then on your mobile device.



When pairing succeeds "dexi-piano-xx" is added to the list of paired devices in the mobile device. Viceversa the mobile device is added to the list of "Paired" devices of VIVO H10 MG.

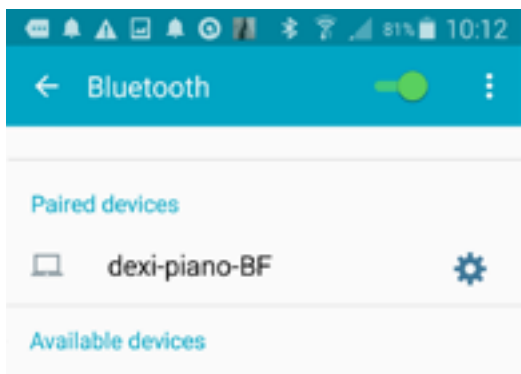

6. Select the "dexi-piano-xx" device that is shown in the paired devices list of your mobile device.

MEMO

For details, refer to the owner's manual of your mobile device.

MEMO

Once the devices have been paired, there is no need to perform pairing again. Once the device is recognized, the VIVO H10 MG ask you to authorize the connection:



Choose "YES" to authorize the connection. The following page appears:



The connection is now established and a Bluetooth® icon is shown in the main menu. The music data played back by the mobile device can be heard through VIVO H10 MG.

NOTE

Pairing is required again if you execute a Factory Reset (p. 36).

1. Place the mobile device within 1 meter (3 ft) from the VIVO H10 MG.
2. If necessary, turn on the Bluetooth® function on the mobile device.
3. Select the "Dexi-piano-xx" device that is shown in the Bluetooth® list of your mobile device.

MEMO

For details, refer to the owner's manual of your mobile device.

Using Bluetooth® Audio

You can use the speakers of the VIVO H10 MG to listen to music or music videos played on your mobile device.

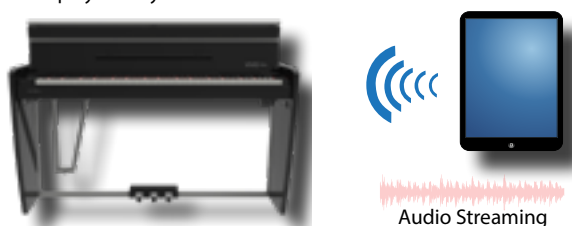

1. If necessary, turn on the Bluetooth® function of the VIVO H10 MG and pair your mobile device. You don't need it if it's already paired.
See "Turning on the VIVO H10 MG's Bluetooth Function" (p. 59) and "Connecting with the Mobile Device" (p. 59).
2. Locate your mobile device near the VIVO H10 MG.
3. Turn on the Bluetooth® function of your mobile device.

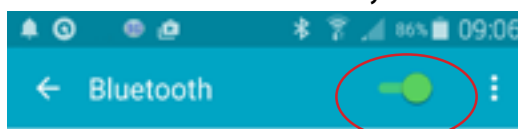

All music data played back by the your mobile device can be now heard through VIVO H10 MG.

Transferring Bluetooth® MIDI Data

Here's how to do for transmitting and receiving MIDI data between the VIVO H10 MG and your mobile device.



In particular, we will take as an example the connection between the VIVO H10 MG and the "Dexibel VIVO EDITOR" application.

Connecting an Already Paired Mobile Device

NOTE

Please take in consideration that the explanation to connect your mobile device with the VIVO H10 MG is as an example. The operations to connect your mobile device can be different from our explanation and depend on the operating system of your device. For details, please refer to the owner's manual of your mobile device.



What is the "Dexibell VIVO EDITOR" application?
It a free iOS application downloadable from **Apple Store**.

What does the "Dexibell VIVO EDITOR" do?
It allows you to modify any parameter of the VIVO H10 MG in realtime. It is as if the device becomes the color display with touch screen of your instrument.

1. Turn on the "Visible" parameter of the VIVO H10 MG in the bluetooth page and pair your mobile device.
See "Turning on the VIVO H10 MG's Bluetooth Function" (p. 59) and "Connecting with the Mobile Device" (p. 59).
2. Locate your mobile device near the VIVO H10 MG.
3. Turn on the Bluetooth® function of your mobile device.

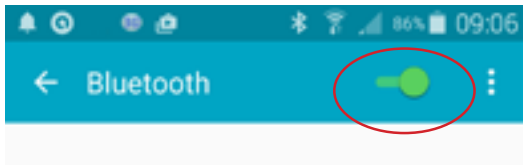

4. Start the "Dexibell VIVO EDITOR" and tap the "MEMORY" page.



5. Tap the "⚙️" icon.



6. In the Bluetooth MIDI field, Tap the "DEVICE" button.

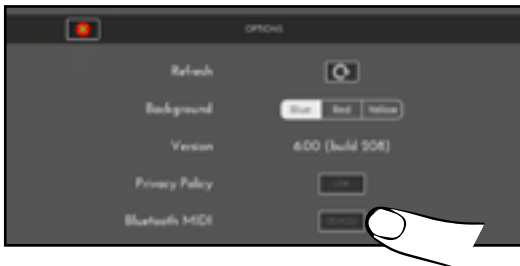

The Bluetooth MIDI devices page is opens and the VIVO H10 MG (dexi-piano-xx) is in the list of found devices.

7. Tap "Not Connected" to connect the VIVO H10 MG (dexi-piano-xx).



Wait until the VIVO H10 MG is connected.

8. Tap "Done" to exit from the page.



Now you can change a tone, activate or deactivate a part, modify the octave, select functions and so on. Now if you want, you can control every function of your instrument by this application without using the VIVO H10 MG's panel anymore.



The VIVO H10 MG's [MENU] button provides access to the available parameters and functions.

General procedure

1. Press the [MENU] button.

The display changes to:



2. Use the [▲] [▼] buttons to select the entry of the desired function group.

3. Press the [▶] button to go to the display page where you can edit the parameters of the selected group, or to execute the selected command.

For more details about the parameters selection, see "Moving the cursor and setting parameter values" (p. 25).

The following parameters and functions are available:

Parameters Group



SETTING Parameters Group	63
MAIN SETTING	63
Level	63
Panpot	63
Octave	63
Mute	63
Coarse Tune	63
Fine Tune	63
Note Low	63
Note High	63
COUPLED SETTING	63
Level	63
Panpot	63
Octave	63
Mute	63
Coarse Tune	63
Fine Tune	63
Note Low	63
Note High	63
LOWER SETTING	63
KEYBOARD TOUCH	63
TRANSPOSE	63
SPLIT MODE	63
Split Point	63
Split	64
4 HANDS MODE	64
TZL EDITOR	64
EFFECTS	64
MAIN FX	64
LOWER FX	64
COUPLED FX	64
REVERB	64
MASTER EQ	64
MICROPHONE	64
SPEAKER LEVEL	64
CONTROL	64
VOLUME	64
DAMPER PEDAL	64
Part	65
CENTRAL PEDAL	65
Funct.	65
Part	65

LEFT PEDAL	65
Funct.	65
Part	65
TEMPO	65
TEMPO/TAP	66
METRONOME	66
TUNING	66
MASTER TUNE	66
TEMPERAMENT	66
Equal Flat	66
Equal Stretch (default)	66
VIVO Stretch	66
Vallotti	66
Just Major	66
Pythagorean	66
Mean-Tone	66
Werckmeister III	66
Kimberger III	66
User 1, User 2, User 3	66
MEMORY	67
USB MEMORY	67
REMOVE	67
FORMAT	67
USB AUDIO	67
Input Level	68
Output Level	68
BLUETOOTH	68
MIDI	68
RECEPTION	68
Main, Coupled, Lower	68
Status	68
Channel	68
Shift	68
Modulation	68
Volume	68
Panpot	68
Expression	68
Reverb	68
Hold	68
Sostenuto	68
Soft	68
PG (Program Change)	68
PB (Pitch Bender)	68
Memory	69
Status	69
Channel	69
TRANSMISSION	69
Main, Coupled, Lower	69
Status	69
Channel	69
Shift	69
Local	69
Modulation	69
Volume	69
Panpot	69
Expression	69
Reverb	69
Hold	69
Sostenuto	69
Soft	69
PG (Program Change)	69
PB (Pitch Bender)	69
Memory	69
Status	69
Channel	69
MIDI SET	69
SAVE MIDI SET	69
EXPORT MIDI SET	69
IMPORT MIDI SET	69
GLOBAL	70
Speaker	70
Auto OFF	70
Pedal	70
Auto On	70
4 Hands	70

Lid Sensor	70
SOUND LIBRARY	70
SOUND SETUP	70
FACTORY RESET	70
FACTORY SOUND	70
BACKUP	70
VERSION INFO	70

NOTE

The parameters can be stored in various memory areas. The following table shows you how to know in which area it is stored.

Icons	Explanation
	This symbol indicates that the parameter or the parameters group can be stored in the Internal Memory area. See "Working with the Memories" (p. 53).
	This symbol indicates that the parameter or the parameters group can be stored in the Global Internal Memory area. The Global Internal Memory Area is automatically saved when you turn off the instrument.

NOTE
Use the appropriate button to turn off the instrument. Do not disconnect the power adapter from the outlet before the instrument is turned off.

SETTING Parameters Group

[MENU] button →SETTING

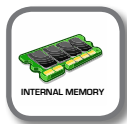

In this parameters group you can access to the important settings of your digital piano.



▶ **MAIN SETTING**

This is where you can edit parameters related to keyboard Main part

Parameter	Setting	Explanation
Level	0 ~ 127	Adjusts the volume of the Main keyboard part. Selecting "0" means that the part is question is no longer audible.
Panpot	-64 ~ 0 ~ +63	Use this parameter to set the stereo placement of the signal. "0" means "no change", negative values shift the signal towards the left, and positive values shift it towards the right.

Parameter	Setting	Explanation
Octave	-4 ~ 0 ~ +4	Use this parameter to transpose the Main part up or down by up to 4 octaves.
Mute	OFF, ON	Select "ON" to mute the keyboard part.
Coarse Tune	-24 ~ 0 ~ +24	The Coarse and Fine Tune are used to create interference pattern between two sounds of slightly different frequencies. Changes the pitch in semi-tone steps.
Fine Tune	-99 ~ 0 ~ +99	Changes the pitch in steps of 1 cent (1/100 semi-tone).
Note Low	A0 ~ B7	You can set the keyboard range for the Main part.
Note High	Bb0 ~ C8	

▶ **COUPLED SETTING**

Contains the parameters for the Coupled part.

Parameter	Setting	Explanation
Level	0 ~ 127	Same settings as Main part. See above.
Panpot	-64 ~ 0 ~ +63	
Octave	-4 ~ 0 ~ +4	
Mute	OFF, ON	Select "ON" to mute the keyboard part.
Coarse Tune	-24 ~ 0 ~ +24	The Coarse and Fine Tune are used to create interference pattern between two sounds of slightly different frequencies. Changes the pitch in semi-tone steps.
Fine Tune	-99 ~ 0 ~ +99	Changes the pitch in steps of 1 cent (1/100 semi-tone).
Note Low	A0 ~ B7	You can set the keyboard range for the Coupled part.
Note High	Bb0 ~ C8	

▶ **LOWER SETTING**

Contains the parameters for the keyboard Lower part.

Same settings as Main and Coupled parts. See above.

▶ **KEYBOARD TOUCH**

See "Adjusting the Keyboard Response (Key Touch)" (p. 35).

▶ **TRANPOSE**

This function allows you to transpose the VIVO H10 MG's pitch in semi-tone steps. Depending on the mode setting, this transposition applies to all sections or just a specific setting. For more details see "Transposing the pitch of the keyboard" (p. 32).

▶ **SPLIT MODE**

This parameter allows you to set the point of keyboard split.

MEMO

You can also select this parameter pressing and holding the [] button until the display shown the following page:



Parameter	Setting	Explanation
Split Point	F1 ~ C#7 Default: F3	See "How to change the Split Point" (p. 27).

Parameter	Setting	Explanation
Split	OFF, ON Default: ON	See "How to Play All Parts at the Same Time (Layer or Split mode)" (p. 28).

▶ 4 HANDS MODE

This function divides the keyboard into two sections, left and right zone, so that two people can play the same range of pitches, just as though there were two pianos.

MEMO

You can also select this page pressing and holding simultaneously press the [] and [] button.



For more information regarding these parameters, see "Four Hands Mode" (p. 30).

▶ COUPLED FX

Contains the effect parameters for the Coupled part
Same settings as Main part. See above.

▶ REVERB

See "Adding Reverb to the Sound" (p. 31).

▶ MASTER EQ

See "Master Equalizer" (p. 35).

MICROPHONE

[MENU] button → MICROPHONE



VIVO H10 MG has a series of settings that help you to adapt your voice for different situation. In addition, is possible adjust any MIC parameters as you like to create your personal preset and save it into the memory.

For more details see "Using an Microphone (optional)" (p. 46).

Selecting a MIC Preset

1. Press [MENU/EXIT] button and select the MICROPHONE function. See "Moving the cursor and setting parameter values" (p. 25).

The following page is shown.



T2L EDITOR

[MENU] button → T2L EDITOR

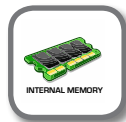

See "Personalizing Your Sounds (T2L)" (p. 42).

EFFECTS

[MENU] button → EFFECTS

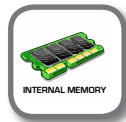

Your instrument contains two multi-effects (FX-A and FX-B) processor that can be used for processing any Keyboard part you like.

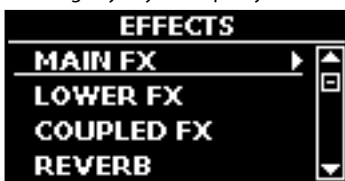

▶ MAIN FX

This selection provides access to the display pages where you can set the effects parameters of the VIVO H10 MG's Main part.

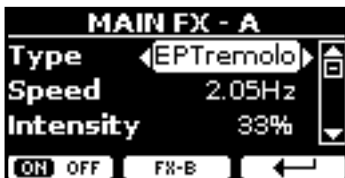

For details regarding effects parameters, refer to the "Effects Types and Parameters" table p. 71.

For more details about the selection of FXs and the relative parameters, see the section "Sound Effects" (p. 31).

▶ LOWER FX

Contains the effect parameters for the keyboard Lower part
Same settings as Main part. See above.

SPEAKER LEVEL

[MENU] button → SPEAKER LEVEL



See "How to Balance the Level of the Internal Speakers (Tweeter, Woofer, Table, Back)" (p. 33).

CONTROL

[MENU] button → CONTROL



▶ VOLUME



See "Adjust the Volume of the VIVO H10 MG" (p. 32).

▶ DAMPER PEDAL

This group of parameters, "DAMPER PEDAL", "CENTRAL PEDAL" and "LEFT PEDAL" are related to the pedal controls. The VIVO H10 MG allows you to manage and assign various function to the pedals.

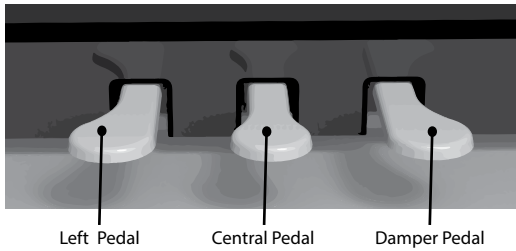

Left Pedal Central Pedal Damper Pedal



Parameter	Setting	Explanation
Part	Off, Main, Coupled, Lower, Main+Lw, Main+Cp, Main+Lw+Cp, Lower+Cp	OFF: Select "OFF" if you don't need damper pedal. MAIN, COUPLED, LOWER, MAIN+LW, MAIN+CP: the damper pedal is assigned to the specified part or parts.

► CENTRAL PEDAL



Parameter	Setting	Explanation
Funct.	OFF, Sostenuto, Soft, FXA On-Off, FXB On-Off, Memory Prev, Memory Next, Rotary S/L, Part On/Off, XMure FillUp, XMure FillDw, XMure SceneUp, XMure SceneDw, XMure Play, XMure Ending, FX Manual, Main Hold, Lower Hold, Coupled Hold Default: Sostenuto	Off: No function assigned See "Pedal Functions Explanation" (p. 65). MEMO Some functions are commands that do not need to specify the part (Main, Coupled, Lower or Bass).
Part	Off, Main, Coupled, Lower, Main+Lw, Main+Cp, Main+Lw+Cp, Low+ Cp	OFF: Select "OFF" if you don't need of pedal. MAIN, COUPLED, LOWER, MAIN+LW, MAIN+CP, MAIN+LW+CP, LOW+CP: the pedal is assigned to the specified part or parts.

► LEFT PEDAL



Parameter	Setting	Explanation
Funct.	OFF, Sostenuto, Soft, FXA On-Off, FXB On-Off, Memory Prev, Memory Next, Rotary S/L, Part On/Off, XMure FillUp, XMure FillDw, XMure SceneUp, XMure SceneDw, XMure Play, XMure Ending, FX Manual, Main Hold, Lower Hold, Coupled Hold Default: Soft	Off: No function assigned See "Pedal Functions Explanation" (p. 65). MEMO Some functions are commands that do not need to specify the part (Main, Coupled, Lower or Bass).
Part	Same as "Int. Part" of CENTRAL pedal. See the above explanation.	

Pedal Functions Explanation

Function	Explanation
Sostenuto	The pedal is used as Sostenuto.
Soft	The pedal is used as Soft The soft pedal reduces the volume and slightly changes the timbre of notes played while the pedal is pressed.
Damper	This assignment is useful when you use the "4 Hands" mode, see "Four Hands Mode" (p. 30).
FXA On-Off FXB On-Off	Allows you to switch the MFXA/B on and off.
Memory Prev Memory Next	Allows you to select the next or previous Memory.
Rotary S/L	This function alternate between the fast and slow Rotary speeds.
Part On/Off	Enable or disable the selected keyboard part.
XMure FillUp XMure FillDw	Using these functions you can select a the next or the previous drum pattern in the XMure® application.
XMure SceneUp XMure SceneDw	These functions allow you to change scene of the accompaniment in the XMure® application.
XMure Play	Play or Stop the playback of a XMure® pattern.
Xmure Ending	Select the Ending pattern.
FX Manual	You can control the "Manual" parameter of the effector. See the "16: Wah-Wah" (p. 73) and the "17: Cut Filter" (p. 73).
Main Hold Lower Hold Coupled Hold	This settings allows you to set the Hold function for the Main, Lower and Coupled part. The movements of the pedal causing the currently sounding notes to be sustained (down) or released (up).

TEMPO

[MENU] button →TEMPO

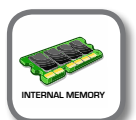



► TEMPO/TAP



Please refer to "How to Adjust the Tempo Value" (p. 34) and "Use Tap Tempo Function to set the Tempo Value" (p. 34).

► METRONOME



Please refer to "Practicing with the Metronome" (p. 33).

TUNING



[MENU] button → TUNING



► MASTER TUNE



Setting	Explanation
415.4 Hz~ 440.00 Hz~ 466.1 Hz	Select the desiderate tuning
"440.00 Hz" Function button	Use the "440.00 Hz" and "442.00 Hz" Function buttons to tuning the instrument at those values.
"442.00 Hz" Function button	

Some Information About the Master Tune

Pianos are generally tuned to an A 440 pitch standard that was adopted during the early 1900s in response to widely varying standards. Previously the pitch standards had gradually risen from about A 415 during the late 1700s and early 1800s to A 435 during the late 1800s. Though A 440 is generally the standard, some orchestras, particularly in Europe, use a higher pitch standard, such as A 444.

► TEMPERAMENT



The modern pianos are tuning in Equal Stretch temperament, in which every pair of adjacent pitches is separated by the same interval.

There are other scale used in different music style. Modern musical scale in western culture are different in one other way from older classic music. At the time of Bach the scales were based on the note A being about 415 Hz. In the Handel's time the frequency A was 422.5 Hz and today it is 440.0 Hz.

Setting	Explanation
Equal Flat	This tuning divides each octave into 12 equal steps (intervals).
Equal Stretch (default)	This tuning is a correction of Equal Flat. A benefit of stretching octaves is the correction of dissonance that equal temperament imparts to the perfect fifth.
VIVO Stretch	This tuning is similar to the Equal Stretch with small adjustments to make it more suitable for piano sounds.
Vallotti	This tuning is the default for many of today's Baroque musicians.
Just Major	This is a just scale for pieces in mayor keys.
Pythagorean	This system was invented in ancient Greece. It resolves the ambiguity of fourths and fifths. Though thirds are somewhat imperfect, melodies sound clearer.
Mean-Tone	A temperament that adds some compromises to the just temperament and facilitates transposition.
Werckmeister III	A combination of the Mean Tone and Pythagorean temperaments, this tuning allows for playing in any key.
Kimberger III	As a result of improvements made to the Mean Tone and Just temperaments, this tuning system is relatively tolerant towards transposition and can be used to play in all keys.
User 1, User 2, User 3	User 1, User 2, User 3: These settings refer to the tuning systems programmed by yourself (or someone else).

1. Select your favorite temperament scale .
2. Press the "RECALL" Function button to load the scale.
The temperament scale is recalled.

Editing the Equal Flat, Equal Stretch or Vivo Stretch scale

If you selected the Equal Flat, Equal Stretch or Vivo Stretch scale:
The "EDIT" Function button appears.

1. Press the "EDIT" Function button to program your scale.



In the example above we select the Equal Stretch scale.

2. To select a note, use the [▲][▼] or play a note on the keyboard.

- Use the [◀][▶] buttons to modify the tuning of the selected note.
- Press [FINE] Function button to change the tuning in steps of 1/100 of cent.

Setting	Explanation
-99.99 ~ 0 ~ +99.99 (cent)	Set the note tuning.



- Press the "WRITE" Function button to save your scale.
The following page appears:



- Use the [▲][▼] buttons to select the USER scale where you want save your scale.
- Press the "WRITE" Function button to save your scale.
A message of confirmation appears.

If you selected a scale other than equal temperament:

- If you selected a scale other than equal temperament as Pythagorea, Mean-Tone, Werckmeister III, Kimberger III and the Just Major and Minor temperament scale, you can specify the root note:
The "ROOT NOTE" Function button appears.



- Press the "ROOT NOTE" Function button if you want specify the base note.



- Select the root note.

Setting	Explanation
C, C#, D, Eb, E, F, F#, G, Ab, A, Bb, B	Select the base note of the temperament scale.

- Press the "←" Function button come back to previous page.

If you selected one of USER scales:
The "EDIT" Function button appears.



- Press the "EDIT" Function button to program your scale.

- To select a note, use the [▲][▼] or play a note on the keyboard.
- Use the [◀][▶] buttons to modify the tuning of the selected note.
- Press [FINE] Function button to change the tuning in steps of 1/100 of cent.

Setting	Explanation
-99.99 ~ 0 ~ +99.99 (cent)	Set the note tuning.

- Press the "WRITE" Function button to save your scale.
A message of confirmation appears.
- Press the "←" Function button come back to previous page.

MEMORY

[MENU] button → MEMORY

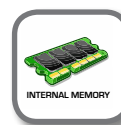

For the explanation of this section please refer to "Working with the Memories" (p. 53).

USB MEMORY

[MENU] button → USB MEMORY



- ▶ REMOVE
Before to unplug the USB Memory, use this function to safely remove it. See "Safely Remove the USB Memory" (p. 22).
- ▶ FORMAT
Use this function to format your USB Memory. See "How to Format the USB Memory" (p. 22).

USB AUDIO

[MENU] button → USB AUDIO

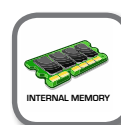

Use this function if you need to adjust the audio output and input levels via USB.



Parameter	Setting
Input Level	-inf ~ 0 dB Default: 0 dB
Output Level	-inf ~ 0 dB Default: 0 dB

BLUETOOTH

[MENU] button → BLUETOOTH

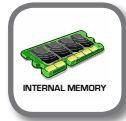

VIVO H10 MG Pianos are equipped with Audio and MIDI Bluetooth® (4.2 Low Energy) function.

Thanks to this technology, you'll be able to stream music and send MIDI data wirelessly from a Bluetooth® capable smartphone, tablet or computer to VIVO H10 MG.

For details see "Wireless Function" (p. 59).

MIDI

[MENU] button → MIDI

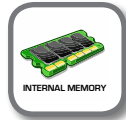

This group allow you to configure the MIDI parameters. You can transfer MIDI data between the VIVO H10 MG and your sequencer software.



Here is a brief explanation of VIVO H10 MG keyboard parts:

Part	Explanation
Main	At power-on, the instrument is automatically selected in Grand Piano Mode. All keyboard play note in the Main part. Main Part
Coupled	This part can be combined with the Main part. To do this press the [] button. The second part (Coupled Part) play over the entire keyboard in combination with the Main part. Main Part + Coupled Part
Lower	This part is activated when you split the keyboard in two zone: Left and Right. To split the keyboard press the [] button. The Keyboard is now divided into two sections. The region of the keyboard to the left of the split point becomes the Lower part, while the region of the keyboard to the right of the split point becomes the Main part. Lower Part Main Part

1. Select the group of parameters you need (Reception, Transmission and Global).

► RECEPTION



You can configure the MIDI receive parameters of Main, Coupled and Lower part.

1. Select the part you want to edit (Main Coupled and Lower).



In the example above we selected the Main keyboard part.

Main, Coupled, Lower		
Parameter	Setting	Explanation
Status	Off, On Default: On	Select "On" if you want the selected part to receive MIDI data.
Channel	1 ~ 16 Default: 1	Allows you to assign a MIDI receive channel to the selected part.
Shift	-48~0~+48 Default : 0	This parameter allows you to transpose the received note messages before sending them to the VIVO H10 MG's tone generator. The maximum possible transposition is four octaves up (48) and down (-48). Each step represents a semi-tone.
Modulation	Off, On Default: On	These filters allow you to specify whether (On) or note (Off) the messages in question should be received.
Volume		
Panpot		
Expression		
Reverb		
Hold		
Sostenuto		
Soft		
PG (Program Change)		
PB (Pitch Bender)		

Part	MIDI RX channel (default)
Main	1
Coupled	2
Lower	3
Memory	15

2. If you selected the "Memory" part, the following page is showed:



Memory		
Parameter	Setting	Explanation
Status	OFF, ON Default: On	Select "On" if you want to receive MIDI messages for the memories selection.
Channel	1 ~ 16 default: 15	Allows you to assign a MIDI receive channel to the "Memory" part.

Memory		
Parameter	Setting	Explanation
Status	OFF, ON Default: On	Select "On" if you want to transmit MIDI messages when you recall a memory. See "Working with the Memories" (p. 53).
Channel	1 ~ 16 default: 15	Allows you to assign a MIDI transmit channel to the "Memory" part.

► TRANSMISSION



You can configure the MIDI transmission parameters of Main, Coupled and Lower part.

1. Select the part you want to edit (Main Coupled and Lower).



In the example above we selected the Main part.

Main, Coupled, Lower		
Parameter	Setting	Explanation
Status	Off, On Default: On	Select "On" if you want the selected part to transmit MIDI data.
Channel	1 ~ 16 Default: 1	Allows you to assign a MIDI transmit channel to the selected part.
Shift	-48~0~+48 Default : 0	This parameter allows you to transpose the note messages before they are transmitted to an external MIDI device. The maximum possible transposition is four octaves up (48) or down (-48).
Local	Off, On Default: On	You can disconnect the part from the internal sound source ("Off") – or re-establish that connection ("On").
Modulation	Off, On Default: On	These filters allow you to specify whether (On) or note (Off) the messages in question should be transmitted.
Volume		
Panpot		
Expression		
Reverb		
Hold		
Sostenuto		
Soft		
PG (Program Change)		
PB (Pitch Bender)		

2. If you selected the "Memory" part, the following page is shown:



► MIDI SET

MIDI Sets are memories for MIDI settings. The VIVO H10 MG provides four MIDI Set memories. The first memory, called "Dexibell", is read-only and allows you to restore the MIDI factory setting. The other three memories allow use to memorize and recall your MIDI configuration.



1. Use the [▲][▼] to select the MIDI Set and press the "RECALL" Function button to load it.
2. Press the "SAVE" Function button to jump in the SAVE MIDI SET page.

► SAVE MIDI SET



1. Use the [▲][▼] to select the MIDI Set memory and press the "WRITE" Function button to save your configuration.

► EXPORT MIDI SET

You can save your MIDI SET in a USB Memory.



1. Connect the USB Memory to which you wish to save the data. See "Connecting an USB Memory (commercially available)" (p. 21).
2. Use the "OPEN" F1 function button to select the folder where you want save the data.
3. Press the "EXPORT" F2 function button to perform the export operation.

► IMPORT MIDI SET

You can load your MIDI SET previous saved in a USB Memory.



1. Connect a USB Memory containing the previously saved MIDI SET data. See "Connecting an USB Memory (commercially available)" (p. 21).

- Use the "OPEN" F1 function button to select the folder that contains the data.
- Press the "IMPORT" F2 function button to perform the operation

GLOBAL

[MENU] button →GLOBAL



These parameters allow you to adjust some global aspect of your piano. These parameters are automatically saved in the VIVO H10 MG global memory area.



Parameter	Setting	Explanation
Speaker	OFF, ON, AUTO	<p>OFF: When you use VIVO H10 MG for live performances and therefore connect it to an external amplification system, it may be convenient to switch off the internal speakers.</p> <p>ON: Choose this option if you want to use VIVO H10 MG internal speakers. Connecting a pair of headphones, the internal speakers continue to produce sound.</p> <p>AUTO: Choose this option if you want to use the VIVO H10 MG internal speakers. Connecting a pair of headphones mutes the internal speakers.</p>
Auto OFF	Off, 5 min, 10 min, 30 min, 2 hours, 4 hours Default: 2 hours	<p>This parameter allows you to cause the VIVO H10 MG to switch itself off after the selected number of minutes has elapsed if you are not using it.</p> <p>Select "Off" if you prefer not to use this function.</p>
Pedal	Global, Memory	<p>Global: Set this value if you want the pedal assignments are saved in the global area. The pedal assignment does not depend on the recalled memory.</p> <p>Memory: Set this value if you want the pedal assignments are saved in the Memories. The pedal assignment depends on the recalled memory.</p>
Auto On	OFF, ON,	<p>ON: Set this value if you want the instrument to turn on automatically when it is powered. This can be useful in a shop when you turn on the electrical panel in the morning.</p> <p>OFF: Set this value if you don't want the instrument to turn on automatically when it is powered.</p>
4 Hands	4 Hands, Split+Layer	<p>4 Hands: Use this setting if you want play in duet (4 hand) pressing the [] and [] button simultaneously.</p> <p>Split+Layer: Use this setting to play all parts (three tones) in layer or split mode pressing the [] and [] button simultaneously.</p>
Lid Sensor	OFF, ON	<p>OFF: The Lid Sensor does not act (default).</p> <p>ON: Choose this option if you want to exclude the amplification of the soundboard and the rear speakers box when the main lid is closed.</p>

SOUND LIBRARY

[MENU] button →SOUND LIBRARY

You can import sounds library in the internal memory of VIVO H10 MG and use them in your performances. For details see "Additional Sound (Sound Library)" (p. 38).

SOUND SETUP

[MENU] button →SOUND SETUP

This is a useful function that allows you to prepare a sound set for a performance. For details see "Sound Setup (Export/Import)" (p. 41).

At your convenience, you can also download sound sets from the <http://www.dexibell.com/> website

FACTORY RESET

[MENU] button →FACTORY RESET

This function allows you to recall the VIVO H10 MG's original factory settings. Please see "Restoring the Factory Settings (Factory Reset)" (p. 36).

FACTORY SOUND

[MENU] button →FACTORY SOUND

This function allows you to restore all sound libraries as they came out of the factory. Please see "Restore the Factory Sounds" (p. 36).

BACKUP

[MENU] button →BACKUP

This function allows you to backup your data. See "How to Protect Your Settings, Contents and Sounds List (Backup)" (p. 37)

VERSION INFO

[MENU] button →VERSION INFO

This page shows you the version number of the VIVO H10 MG's operating system.

Effects Types and Parameters List

1: Thru

The effects processor is bypassed.

2: EP Tremolo

This effect cyclically modulates (Speed) the amplitude (Intensity) to add tremolo to the sound. It's the electric piano typical effect.

Parameter	Setting	Explanation
Speed	0.10 ~ 12.50 Hz	Sets the speed of the tremolo effect.
Intensity	0 ~ 100	Depth to which the effect is applied.

3: Equalizer

This is a four-band stereo equalizer (low, mid x 2, high).

Parameter	Setting	Explanation
Low Freq	40 ~ 400 Hz	Selects the frequency of the low range.
Low Gain	-12 ~ 0 ~ +12	Adjusts the gain of the low frequency.
High Freq	400 Hz ~ 8 KHz	Selects the frequency of the high range.
High Gain	-12 ~ 0 ~ +12	Adjusts the gain of the high frequency.
Mid1 Freq	100Hz ~ 4 KHz	Selects the frequency of the Mid1 range.
Mid1 Gain	-12 ~ 0 ~ +12	Adjusts the gain of the Mid1 frequency.
Mid1 Q	0.5 ~ 12.0	Move this parameter to adjust the width of the area around the Middle 1 frequency that will be affected by the Gain setting. Higher values of Mid1 Q set narrowest area.
Mid2 Freq	100Hz ~ 4KHz	Selects the frequency of the Mid2 range.
Mid2 Gain	-12 ~ 0 ~ +12	Adjusts the gain of the Mid2 frequency.
Mid2 Q	0.5 ~ 12.0	Move this parameter to adjust the width of the area around the Middle 2 frequency that will be affected by the Gain setting. Higher values of Mid2 Q set narrowest area.

4: Vibrato

Vibrato is a musical effect consisting of a regular, pulsating change of pitch. It is used to add expression to instrumental music.

Parameter	Setting	Explanation
Rate	0.10 ~ 12.50 Hz	Sets the speed of the vibrato effect.
Intensity	0 ~ 100	Allows you to set the vibrato intensity.

5: Flanger

This effect gives a significant swell and movement of pitch to the sound. It produces a metallic resonance effect.

Parameter	Setting	Explanation
Rate	0.10 ~ 12.50 Hz	Adjust the modulation speed.
Intensity	0 ~ 100	Allows you to set the flanger intensity.

Parameter	Setting	Explanation
Feedback	-96 ~ +96 %	Adjusts the proportion of the flanger sound that is fed back into the effect. Negative (-) settings will invert the phase.
Balance	0 ~ 100	Balance the Volume between the direct and the effect sound.
PreDelay	0 ~ 100 ms	Adjusts the delay from the direct signal and the moment when the flanger starts working.
Phase	0 ~ 180 deg	This sets the LFO phase difference between the left and right, in steps of 10 degrees It give more spatial of the sound.

6: Chorus

This effect adds thickness and warmth to the sound by modulating the delay time of the input signal. You can add spread to the sound by offsetting the phase of the left and right LFOs from each other.

Parameter	Setting	Explanation
Rate	0.10 ~ 12.50 Hz	Adjust the modulation speed.
Intensity	0 ~ 100	Allows you to set the chorus intensity.
Feedback	-96 ~ +96 %	Adjusts the proportion of the chorus sound that is fed back into the effect. Negative (-) settings will invert the phase.
Balance	0 ~ 100	Balance the Volume between the direct and the effect sound.
PreDelay	0 ~ 100 ms	Adjusts the delay from the direct signal and the moment when the chorus starts working.
Phase	0 ~ 180 deg	This sets the LFO phase difference between the left and right, in steps of 10 degrees.

7: Phaser

This effect creates a swell by shifting the phase. It is very effective on electric piano sounds. You can add spread to the sound by offsetting the phase of the left and right LFOs from each other.

Parameter	Setting	Explanation
Rate	0.10 ~ 12.50 Hz	Adjust the modulation speed.
Intensity	0 ~ 100	Allows you to set the phaser intensity.
Feedback	-96 ~ +96 %	Adjusts the proportion of the phaser sound that is fed back into the effect. Negative (-) settings will invert the phase.
Phase	0 ~ 180 deg	This sets the LFO phase difference between the left and right, in steps of 10 degrees.

8: Reverb

This effect adds reverberation to the sound, simulating an acoustic space as a room or a larger halls or stadiums.

Parameter	Setting	Explanation
Level	0 ~ 127	Set the quantity of Reverb effect
Damping	0 ~ 127	Adjusts the amount of damping of the room (Carpet, Wood, Brick, Concrete, Marble). Higher values increase the amount of high-frequency attenuation.

Parameter	Setting	Explanation
Room Size	0 ~ 127	It determines the size of the simulated room.
Width	0 ~ 127	Adjusts the stereo width of the Reverb effect. Higher value increase the stereo width.
PreDelay	0 ~ 100 ms	Adjusts the delay from the direct signal and the moment when the reverb starts working. This is used to simulate the distance between the original signal and the reflective surfaces.

9: Delay

The delay effect is used to simulate echo (repetition).

Parameter	Setting	Explanation
Delay L	0 ~ 750 ms	Sets the delay time for the left channel.
Delay R	0 ~ 750 ms	Sets the delay time for the right channel.
Feedback	-96 ~ +96 %	Adjusts the proportion of the delay sound that is fed back into the effect. Negative (-) settings will invert the phase.
Wet	0 ~ 100 %	Adjust the quantity of the delayed ("wet") signal.
Dry	0 ~ 100 %	Adjust the quantity of the unmodified ("dry") signal.

10: Cross Delay

Cross Delay allows you to create advanced stereo delay.

Each echo can be sent to the opposite channel from the source signal (echo of the left channel is heard on the right).

Parameter	Setting	Explanation
Delay L	0 ~ 750 ms	Sets the delay time for the left channel.
Delay R	0 ~ 750 ms	Sets the delay time for the right channel.
Feedback	-96 ~ +96 %	Adjusts the proportion of the delay sound that is fed back into the effect. Negative (-) settings will invert the phase.
Wet	0 ~ 100 %	Adjust the quantity of the delayed ("wet") signal.
Dry	0 ~ 100 %	Adjust the quantity of the unmodified ("dry") signal.

11: Triple Tap Delay

The Triple Tap Delay produces three delay sounds: center, left and right..

Parameter	Setting	Explanation
Delay L	0 ~ 750 ms	Sets the delay time for the left channel.
Delay R	0 ~ 750 ms	Sets the delay time for the right channel.
Delay C	0 ~ 750 ms	Sets the delay time for the center (L+R) channel.
Feedback	-96 ~ +96 %	Adjusts the proportion of the delay sound that is fed back into the effect. Negative (-) settings will invert the phase.
Level L	0 ~ 100	Adjust the volume of the left delay sound.
Level R	0 ~ 100	Adjust the volume of the right delay sound.
Level C	0 ~ 100	Adjust the volume of the center delay sound.
Wet	0 ~ 100 %	Adjust the quantity of the delayed ("wet") signal.
Dry	0 ~ 100 %	Adjust the quantity of the unmodified ("dry") signal.

12: Rotary

The rotary is a typical effect generated by the rotation of the speakers, this rotation creates a Larsen effect. It gives spaciousness to the sound.

Parameter	Setting	Explanation
Speed	Slow, Fast	Switches the speaker rotation speed between slow and fast.
Brake	OFF, ON	This parameter allows you to manually control the wheel brake. Off is the default; the tone wheels will turn normally. Changing this to On will make the tone wheels gradually slow down and stop.
Vibrato Sw	OFF, ON	Disable and enable the vibrato effect.
Vibrato Type	V1, C1, V2, C2, V3, C3	This selects one of the six classic Vibrato/Chorus presets. "V" stands for Vibrato, and "C" stands for Chorus.

13: Tremolo

This effect cyclically modulates (Speed) the amplitude (Intensity) to add tremolo to the sound.

Parameter	Setting	Explanation
Speed	0.10 ~ 12.50 Hz	Sets the speed of the tremolo effect.
Intensity	0 ~ 100	Depth to which the effect is applied.

14: Tremolo Pan

This effect is similar to the Tremolo. It include an extra parameter that indicate the phase between the left or right channel.

Parameter	Setting	Explanation
Speed	0.10 ~ 12.50 Hz	Sets the speed of the tremolo effect.
Intensity	0 ~ 100	Depth to which the effect is applied.
Phase	0 ~ 180 deg	This sets the LFO phase difference between the left and right, in steps of 10 degrees.

15: Overdrive

This effect is designed to work and sound like an old tube amp turned up loud. It suitable for hard rock and similar musical genres.

Parameter	Setting	Explanation
Drive	1 ~ 100	Higher Drive settings, mean more distortion.
Tone	100 Hz ~ 10.0 KHz	Use this parameter to accent or attenuate certain dominant or unwanted overtones.
Level	0 ~ 100	Increase or decrease the volume of the effect.
Low Freq	80 ~ 400	Selects the frequency of the low range.
Low Gain	-12 ~ 0 ~ +12	Adjusts the gain of the low frequency.
High Freq	800Hz ~ 8KHz	Selects the frequency of the high range.
High Gain	-12 ~ 0 ~ +12	Adjusts the gain of the high frequency.

16: Wah-Wah

It is a type of effect that alters the tone and frequencies of the input signal to create a unique sound, mimicking the human voice and taking the onomatopoeic name "Wah-Wah".

Parameter	Setting	Explanation
Mode	Auto, Manual, Envelope	<p>Auto: The "Manual" parameter is automatically controlled by the internal LFO.</p> <p>Manual: The "Manual" parameter is controlled by the Central and Left pedal. See "CENTRAL PEDAL" (p. 65) and "LEFT PEDAL" (p. 65).</p> <p>Envelope: the effect is controlled by the envelope of the sound and consequently by the dynamics of the notes played on the keyboard.</p>
Manual	0 ~ 127	<p>Adjusts the center frequency at which the effect is applied.</p> <p>This parameter is controlled by the Central and Left pedal. See "CENTRAL PEDAL" (p. 65) and "LEFT PEDAL" (p. 65).</p>
Filter	Low Pass, High Pass, Band Pass, Peak	<p>Low Pass : The wah effect will be applied over a low frequency range.</p> <p>High Pass: The wah effect will be applied over a high frequency range.</p> <p>Band Pass : The wah effect will be applied over a narrow frequency range.</p> <p>Peak: The wah effect will be applied over a specific center frequency.</p>
Low Freq	100Hz ~ 10.0KHz	Selects the frequency of the low range.
High Freq	100Hz ~ 10.0KHz	Selects the frequency of the High range.
Low Q	0.5 ~ 10.0	Move this parameter to adjust the width of the area around the Low or High Frequency.
Hi Q	0.5 ~ 10.0	
LFO Rate	0.1Hz ~ 12.50Hz	Frequency of modulation.
LFO Curve	Linear, Quadratic	LFO curve trend.
Balance	0 %~ 100%	Adjusts the balance between original and the effect sound.
Env Threshold	-40dB ~ 0dB	Adjust the threshold of the envelop
Env Attack	0ms ~ 250ms	Adjust the attack of the envelop
Env Release	0ms ~ 1000ms	Adjust the release of the envelop

17: Cut Filter

This filter that attenuates ("cut") some frequency range.

Parameter	Setting	Explanation
Manual	0 ~ 127	<p>Adjusts the center frequency at which the effect is applied.</p> <p>This parameter is controlled by the Central and Left pedal. See "CENTRAL PEDAL" (p. 65) and "LEFT PEDAL" (p. 65).</p>
Slope	12db/Octave, 24db/Octave	The slope of filter attenuation is usually quantified in decibels per octave.

Parameter	Setting	Explanation
Type	Low Pass, High Pass, Band Pass, Peak	<p>Low Pass : Attenuates the frequencies above a cutoff frequency, allowing low frequencies to pass through the filter.</p> <p>High Pass: Attenuates the frequencies below a cutoff frequency, allowing high frequencies to pass through the filter.</p> <p>Band Pass : The filter is applied over a narrow frequency range.</p> <p>Peak: The filter is applied over a specific center frequency.</p>
Low Freq	100Hz ~ 10.0KHz	Selects the frequency of the low range.
High Freq	100Hz ~ 10.0KHz	Selects the frequency of the High range.
Low Q	0.5 ~ 10.0	Move this parameter to adjust the width of the area around the Low or High Frequency.
Hi Q	0.5 ~ 10.0	

18: Compressor

This filter that attenuates ("cut") some frequency range.

Parameter	Setting	Explanation
Threshold	-40dB ~ 0dB	The compression is activated only when the input signal exceeds the threshold level. Input levels above the threshold will be compressed, and input levels below the threshold will not be compressed.
Ratio	1:1 ~ inf:1	<p>This parameter determines how strong is the compression.</p> <ul style="list-style-type: none"> At 1:1, the compressor has no effect. For all other values the output signal will be compressed in according to the ratio value. At Inf:1, the compressor becomes a brick-wall limiter; once the signal hits the Threshold, the output level will no longer increase, regardless of the input level.
Knee Width	0.0 ~ 1.0	Increasing this value will produce a more soft volume change around the Threshold level.
Attack Time	0ms ~ 250ms	This parameter determines how quickly the compressor will take affect after the signal crosses above the threshold.
Release Time	0ms ~ 1000ms	This parameter controls how quickly the compressor will stop reducing volume level after the signal falls below the threshold.
Makeup	-24dB ~ -24dB	Allows you to boost the compressed signal. as compression often attenuates the signal significantly.
Stereo Link	Off, On	Set the parameter "On" to operate in stereo mode.

VIVO H10 MG Tone List

Num.	Name	PC	CC00
MODERN			
0001	Italian Live PLT	1	71
0002	Italian PLT	1	70
0003	Italian Classic PLT	1	72
0004	Italian Bright PLT	1	73
0005	Italian Memory PLT	1	74
0006	VIVO Upright	1	2
0007	Elec.Grand	3	2
0008	E.Grand Trem	3	3
0009	Rock Piano	3	1
CLASSIC			
0010	USA Live PLT	1	61
0011	USA PLT	1	60
0012	USA Classic PLT	1	62
0013	USA Bright PLT	1	63
0014	USA Memory PLT	1	64
0015	French Grand	1	80
0016	French Live	1	81
0017	French Classic	1	82
0018	French Bright	1	83
0019	French Memory	1	84
0020	Ragtime	4	0
0021	Harpsi 8'	7	0
0022	Harpsi 4'	7	1
0023	Coupled Hps.	7	2
0024	Harpsi Lute	7	4
0025	Celesta	9	0
E.PIANO			
0026	EPBell Chorus PLT	5	107
0027	EPBell Phaser PLT	5	108
0028	EPBell Tremolo PLT	5	109
0029	EPBell OD PLT	5	110
0030	EPBell Phr+Trm PLT	5	111
0031	EPBell Flanger PLT	5	113
0032	EPBell HardOD PLT	5	114
0033	EPBell Bri+Cho PLT	5	115
0034	EPBell PLT	5	106
0035	70s EP Chorus PLT	5	101
0036	70s EP Phaser PLT	5	102
0037	70s EP Tremolo PLT	5	103
0038	70s EP OD PLT	5	104
0039	70s EP Phr+Trm PLT	5	105
0040	70s EP Bright PLT	5	116
0041	70s EP Bri+Cho PLT	5	117
0042	70s EP Bri+Pha PLT	5	118
0043	70s EP Bri+Tre PLT	5	119
0044	70s EP PLT	5	100
0045	Dirty EPBell PLT	5	112

Num.	Name	PC	CC00
0046	Dyno Stage	5	0
0047	Dyno Trem	5	7
0048	Dyno Bell	5	8
0049	Suitcase	5	1
0050	Phaser EP	5	2
0051	Wurly	5	5
0052	Trem.Wurly	5	6
0053	Soft E.Piano	5	3
0054	Bright E.Piano	5	4
0055	FM Full Tines	6	0
0056	FM E.Piano	6	1
0057	Cool Clav	8	0
0058	Groovy Clav	8	1
0059	Doctor Clav	8	2
0060	Funky Clav	8	3
0061	Wah-Wah Clav	8	4
0062	Drive Clav	8	5
ORGAN			
0063	Jazz Organ	18	0
0064	Pop Organ	17	2
0065	Blues Organ	18	1
0066	Reggae Organ	17	0
0067	R& Organ	17	1
0068	Rock Organ	19	0
0069	Gospel Organ	19	1
0070	888888888	18	2
0071	888233211	18	3
0072	864200357	18	4
0073	686040000	18	5
0074	888604000	18	6
0075	Principal	20	0
0076	Princip&Flute	20	1
0077	Church	20	2
0078	Mixture	20	3
ENSEMBLE			
0079	Large Strings	50	5
0080	Easy Strings	50	10
0081	FastOrchestra	50	4
0082	Attack Strings	49	2
0083	Choir Strings	52	1
0084	MellowStrings	50	6
0085	Soft Strings	50	7
0086	5th Strings	50	8
0087	Slow Analog	50	9
0088	Orchestra	49	1
0089	Classic Choir	53	1
0090	Space Vox	55	1
0091	Mmh Choir	53	0

Num.	Name	PC	CC00
0092	Choir Pad	54	1
0093	Synth Vox	55	0
0094	Warm Pad	90	0
0095	Organ Pad	90	3
0096	Square Pad	90	2
0097	Full Brass	62	3
0098	Trumpet Sect.	57	3
0099	Trumpet	57	2
0100	Tenor Sax	67	0
0101	Soprano Sax	65	0
0102	Alto Sax	66	0
0103	Horns	61	0
0104	Classic Trumpet	57	0
0105	Flugelhorn	57	1
 (MORE)			
0106	Vibraphone	12	0
0107	Marimba	13	0
0108	Clarinet	72	0
0109	Flute	74	0
0110	Harmonica	23	0
0111	Oboe	69	0
0112	Viola	42	0
0113	Violin	41	0
0114	Nylon Guitar	25	0
0115	Steel Guitar	26	0
0116	Elec. Bass	34	2
0117	Soft Slap Bs	37	0
0118	Hard Slap Bs	37	1
0119	5 String Bass	34	1
0120	Picked Bs.	35	0
0121	Fingered Bs.	34	0
0122	Double Bass	33	3
0123	Double Bs&Ride	33	4
0124	Acoustic Bs.	33	0
0125	Ac.Bass&Ride	33	1

24 Troubleshooting

Symptom	Action	Page
Power turns automatically off.	This is normal and due to the Auto Power Off function. If necessary, set the parameter of the Auto Power Off function. If you don't need the power to turn off automatically, turn the "AUTO OFF" setting "Disable".	70
The instrument does not turn on.	Is the AC adaptor/power cord correctly connected to an AC outlet and to the VIVO H10 MG? NOTE Do not use any AC adaptor or power cord other than the ones included. Doing so will cause malfunctions.	18
	Could you have turned the power on again immediately after turning the power off? Allow an interval of at least five seconds before turning the power on again.	-
No sound from the VIVO H10 MG.	Did you switch the VIVO H10 MG on?	22
	Could the [VOLUME] knob be turned down? Select a higher setting.	-
	Could the part volume settings have been minimized? Check the "LEVEL" setting of each part.	63
The volume level of the instrument is too low when it is connected to an amplifier.	Could you be using a connection cable that contains a resistor? Use a connection cable that doesn't contain a resistor.	-
The microphone level is too low.	Make sure that your microphone is connected correctly.	20
	Could the [VOLUME] knob be turned down? Select a higher setting.	46
The keyboard volume is lower than the Song playback volume.	The volume level for the keyboard performance is set too low. Adjust the volume balance to increase the keyboard volume via the Song Control Menu.	51
The pitch of the instrument is incorrect.	Is the "Tuning" or "Temperament" setting appropriate? Check the parameters.	66
	Did you transpose the instrument?	63
A "buzz" is heard from the external amplifier.	Is the external amplifier or other device used with the VIVO H10 MG connected to a different AC power outlet? Connect the amplifier or other device to the same AC outlet as the VIVO H10 MG.	-
	The noise may be due to interference caused by the use of a mobile phone in close proximity to the instrument. Turn off the mobile phone, or use it further away from the instrument.	-
After connecting the VIVO H10 MG's USB COMPUTER port to your computer, the VIVO H10 MG doesn't receive MIDI messages.	The VIVO H10 MG may be receiving on a MIDI channel on which the MIDI controller doesn't transmit. Correct the MIDI controller's transmit channel.	68
Unable to read from/write to USB Memory.	Check the format of your USB Memory. The VIVO H10 MG can use USB Memory that has been formatted as FAT. If your USB Memory was formatted using any other method, please re-format it as MS-DOS FAT.	-
Can't save to USB Memory.	Could the USB Memory be write protected?	-
	Is there sufficient free space on the USB Memory?	-
Audio recording won't start or stops unexpectedly.	Is there sufficient free space on the USB Memory?	-
The songs won't play.	The file type of the song is not one of the file types that the VIVO H10 MG can play.	50
	It may be that the song data is damaged.	-
This "dexi-piano-xx" model name does not appear in the Bluetooth device list of your mobile device.	<ul style="list-style-type: none"> Is the "Visible" parameter of VIVO H10 MG set "On". 	59
The music data played back by the mobile device cannot be heard through VIVO H10 MG.	<ul style="list-style-type: none"> It was initiated the pairing function between this unit and the mobile device? Delete the registration from the list of your mobile device and establish pairing once again. 	59

25 Specifications

ITEMS		VIVO H10 MG
KEYBOARD TYPE	<ul style="list-style-type: none"> • TP-400 W (Hybrid, Wood) 88 Keys - Weighted, Hammer action, Triple contact • Ivory & Ebony feels • Escapement 	
TECNOLOGY/CPU	Quad Core Cortex @ 1.8 GHz 4GB memory	
TONE GENERATOR	T2L: Sampling and Modelling Technology	
SAMPLING	XXL wave size, holophonic recording up to 15 seconds on lower piano notes	
SOUND WAVE FORMAT	24 bit linear - 48 KHz (Internal processing and DSP at 32 bit floating)	
DIGITAL ANALOG CONVERSION (DAC)	24 bit linear - 48 KHz, Dynamic Range, S/N:106dB	
MAXIMUM POLYPHONY	Unlimited with 320 Oscillator	
SOUNDS	125 including 3 PLATINUM sounds User downloadable from website (Sound Font Compatible), using "seamless changes" technology at sound recall	
MEMORY	Preset: 80 User: Unlimited loadable from USB Memory	
WAVE MEMORY	3.2 GB fully changable by the user with DEXIBELL and Sound Font format	
KEYBOARD MODE	Layers, Split, 4 Hands, Layer + Split, 3 parts Layer	
TOUCH SENSITIVITY	7 Types + Fixed	
REVERB	24 Types	
EFFECTS	6 independent DSP Effects x 17 types (2 x Main, 2 x Coupled, 2 x Lower) using "seamless changes" technology at effect recall	
MIC IN EFFECTS	REVERB 14 types, 3-band EQ, Compressor, Low Cut Filter, Delay 6 types	
MASTER EQUALIZER	3-band Digital Equalizer	
PLAYER AUDIO	.wav, .aiff, .mp3, in all format, frequency and bit rate	
RECORDER AUDIO	.wav (48 kHz, 32-bit floating) on USB Memory	
MASTER TUNING	YES: 415,4Hz to 466,1 Hz (adjustable increments of 0,1 Hz) + 2 Preset (440 Hz, 442 Hz)	
TEMPERAMENT	9 Types	
USER TEMPERAMENT	3 User	
RHYTHM PATTERNS	X MURE APP for i-Phone and i-Pad (FREE) with multitracks audio patterns	
METRANOME	Yes with Tap Tempo + 13 Standard Tempo Preset	
CONTROLS	VOLUME, MIC EFFECT, MIC LEVEL	
MUSIC REST	Yes, reclinable	
PEDALS	Progressive Damper Action Pedal with sympatetic resonance simulation Progressive Soft Pedal / Function assignable Sostenuto Pedal / Function assignable	
Keyboard Lid	Folding with soft closing and reclining blind	
Wireless Connections	Audio and MIDI Bluetooth® (4.2 Low Energy) Wi-Fi™ (ready for future software version)	
DISPLAY	Graphic LCD 128 x 64 dots Organic LED, high contrast type	
CONNECTORS	DC IN socket	for supplied AC adaptor
	MIC IN jack	1/4-inch unbalanced mono phone type
	Output (L/Mono, R) jacks	1/4-inch phone type x 2
	Phones jacks	1 x Stereo miniature phone type 1 x Stereo 1/4-inch phone type
	USB COMPUTER port	Type B
	USB MEMORY port	Type A
	Pedals Connector	DIN connector: Left Pedal (Assignable), Center Pedal (Assignable), Right Pedal
SPEAKERS	4 woofer x 8.9 cm (3,5 inches), 6 near-field speakers x 3,2 cm (1,3 inches) 2 Full range x 12.7 cm (5 inches) 3 middle-high range (binaural system) x 6.35 cm (2.5 inches) "Real wooden vibrating Soundboard" near-field speakers x 3,2 cm (1,3 inches)	

ITEMS	VIVO H10 MG
RATED POWER OUTPUT	Quadriamp: 112 W max @ THD+N < 0.1%
DSP ON AMPLIFIER	Dynamic EQ - 3 Band Compressor
AUTO POWER-ON AFTER SHUT-DOWN	Yes, selectable
VOLUME LEVEL SPL	113.6 dB max
POWER SUPPLY	24V DC 5A , supplied AC/DC adaptor
POWER CONSUMPTION	Stand By: < 0,2 W Maximum: 70 W "ErP" LEVEL VI for Echo efficiency on stand-by consumption
DIMENSIONS	Main lid close: 1441 (W) x 866 (D) x 785 (H) 56-3/4 (W) x 34-1/8 (D) x 30-15/16 (H) Main lid fully open: 1441 (W) x 866 (D) x 1504 (H) 56-3/4 (W) x 34-1/8 (D) x 59-1/4 (H)
WEIGHT	87.8 kg (excluding AC adaptor) 193 lbs 10 oz (excluding AC adaptor)
PACKAGE	1 box
SUPPLIED ACCESSORIES	Quick guide AC adaptor (DEXIBELL DYS6150-2400500W)
OPTIONS (sold separately)	Headphone: DEXIBEL DX HF7 Bench: DEXIBELL DX BENCH

- Bluetooth® is registered trademarks of Bluetooth SIG, Inc.
- Wi-Fi™ is registered trademarks of Wi-Fi Alliance.

NOTE

In the interest of product, the specification and description are subject to change without notice.

Simboli

A

- AC Adaptor 16
- Adding a Library 36
- AUTO OFF 20

B

- Balance 27
 - Main and the Lower part 24
- Bluetooth® 56

C

- Computer
 - Connecting Your Computer 18
- CONTROLS 60
- COUPLED FX 60
- COUPLED SETTING 59
- Cursor 21
 - Cursor Operation 21
 - Moving the cursor 22

D

- DAMPER PEDAL 61
- DC IN jack 16
- Demo 20
- Display 21

E

- Effect
 - Reverb Effect 28
- EFFECTS 60
- Export
 - Exporting the Internal Memory Set 52
- Exporting a Sound Set 38
- External Amplifier
 - Connecting an External Amplifier 17

F

- Factory Sounds 33
- File name
 - Assigning the Name You Specify 22
- Four Hands 27,35

G

- GLOBAL 66

H

- Headphones 17

- Listening Through Headphones 16
- How to Format the USB Memory 19

I

- Import
 - Importing Memory Set 53
- Importing a Sound Set 38

J

K

- Keyboard Response (Key Touch)
 - Adjusting the Keyboard Response 31
- KEYBOARD TOUCH 59
- Key Touch
 - Adjusting the Keyboard Response 31

L

- Layer
 - Playing Two Sounds Over the Entire keyboard (Layer) 24
- LAYER MODE 60
- LEFT PEDAL 61
- Lid
 - Opening and Closing the Lid 17
- Lower
 - Mute the Lower Part 25
- LOWER FX 60
- LOWER SETTING 59

M

- MAIN FX 60
- MAIN SETTING 59
- MASTER EQ 60
- MASTER TUNE 62
- Memories
 - Exporting the Internal Memory Set in the USB Memory 52
 - Importing Memory Set from the USB Memory into Internal Memory. 53
 - Recalling your settings from an USB Memory 52
 - Recalling your settings from Internal Memory 50
 - Renaming a Memory 52
 - Saving Your Settings in the Internal Memory 50
 - Working with the Memories 50
- MEMORY 63

MENU

- MENU Options (Advanced Section) 58

Metronome

- Metronome Settings 30
- Practicing with the Metronome 29
- Setting the Metronome Time Signature 31

METRONOME 62

- Metronome Settings 30
- Microphone 43
- MIDDLE PEDAL 61
- MIDI 64

Mute

- Mute the Lower Part 25

N

O

P

- Pairing 56
- Parameters
 - GLOBAL 66
- passkey 56
- PEDAL
 - DAMPER PEDAL 61
 - LEFT PEDAL 61
 - MIDDLE PEDAL 61
- Pedal Cord
 - Connecting the Pedal Cord 16,17
- Power On/Off 19
 - Turning the Power On/Off 19

Q

R

- Record
 - Recording Your Performance 49
- Renamie
 - Renaming a Memory 52
- Reverb
 - Reverb Effect 28
- REVERB 60

S

Save

- Saving Your Settings in the Internal Memory 50
- Saving Your Settings in the USB Memory 50

SETTING

- SETTING Parameters Group 59

Song

- Loading from Song Internal Memory 47

Loading from USB Memory	47
Playing a Song	47
Practice with Song Player	43,47
Sounds	
Personalizing Your Sounds	39
Sound Setup	38
Specifications	72
Split	
Splitting the Keyboard Range and Playing Two Different Tones	24
SPLIT MODE	59
T	
T2L EDITOR	60
T2L-Modelling	39
TAP	
TEMPO/TAP	62
Tap Tempo	
Use Tap Tempo Function to set the Tempo Value	31
TEMPERAMENT	62
Tempo	
How to Adjust the Tempo Value	31
Use Tap Tempo Function to set the Tempo Value	31
TEMPO	62
TEMPO/TAP	62
Tones	
Grand Piano Mode	23
Most Frequently Used Tones (Favorite Tone)	23
Selecting Tones	23
Transpose	
Transposing the pitch of the keyboard or/ and song	29
TRANSCOPE	59
Troubleshooting	71
TUNE	
MASTER TUNE	62
TUNING	62
U	
USB FORMAT	19
USB host	18
USB Memory	
Connecting an USB Memory	19
Exporting the Internal Memory Set in the USB Memory	52
Importing Memory Set from the USB Memory into Internal Memory.	53
Recalling your settings from an USB Memory	52
Saving Your Settings in the USB Memory	50

V	
VOLUME knob	10
W	
Wireless	
Already Paired Mobile Device	57
Wireless Function	55,56
X	
X MURE	55
Y	
Z	



For European Countries

This product complies with the requirements of EMC Directive 2004/108/EC.

For Canada

NOTICE

This Class B digital apparatus meets all requirements of the Canadian Interference-Causing Equipment Regulations.

AVIS

Cet appareil numérique de la classe B respecte toutes les exigences du Règlement sur le matériel brouilleur du Canada.

For European Countries

EUROPEAN COMMUNITY DECLARATION OF CONFORMITY Radio and Telecommunications Terminal Equipment.

Dexibell declares that the wireless module of this unit is in compliance with the essential requirements and other relevant provisions of Directive 1999/5/EC.

IMPORTANT NOTICE FOR THE UNITED KINGDOM

IMPORTANT: THE WIRES IN THIS MAINS LEAD ARE COLOURED IN ACCORDANCE WITH THE FOLLOWING CODE.

BLUE: NEUTRAL
BROWN: LIVE

As the colours of the wires in the mains lead of this apparatus may not correspond with the coloured markings identifying the terminals in your plug, proceed as follows:

The wire which is coloured BLUE must be connected to the terminal which is marked with the letter N or coloured BLACK.

The wire which is coloured BROWN must be connected to the terminal which is marked with the letter L or coloured RED.

Under no circumstances must either of the above wires be connected to the earth terminal of a three pin plug.

DEXIBELL

DEXIBELL
is a brand of

PROEL SPA
(Worldwide Headquarters)
Via alla Ruenia, 37/43
64027 Sant'Omero (TE) - ITALY
Tel. +39 0861 81241
Fax +39 0861 887865
P.I. 00778590679
N.Reg.AEE IT 0802000002762

info@dexibell.com
www.dexibell.com

