

# **MOOER**

**RED TRUCK**

**Combined Effects Pedal**

## **Owner's Manual**

# Precautions

## PLEASE READ CAREFULLY BEFORE PROCEEDING

### Power Supply

Use the correct AC outlet to connect the power adapter. Use a power transformer with a negative external voltage of 9V1A, ⊕—⊖—⊖ otherwise it will cause equipment damage, fire or other problems. When unused or thunderstorms please unplug the power supply.

### Connections

Before connecting the device or disconnecting it, be sure to turn off the power and other equipment, which will help to avoid malfunction and damage to other equipment. Also, make sure that all cables and power cords are disconnected before moving the unit.

### Place the place

To prevent deformation, discoloration, and other serious damage, avoid the following:

- Direct sunlight
- Magnetic field
- Dusty or unclean place
- Strongly vibrating or shakin
- Near heat source
- High temperature and humidity
- Humidity is large

### Electrical interference

When using the unit, the radio and the TV may cause interference. Use the unit away from the radio and the TV.

### Clean

Please use a dry, soft cloth to clean the unit. If necessary, wipe with a slightly moist cloth. Do not use rough clean powder, alcohol, paint thinner, wax, solvent, detergent and chemical agents such as impregnated wipes.

### Operating

Do not use brutal forces to use switches and control elements. Do not allow paper, metal, and other objects to fall into the machine. Be careful not to fall, do not subject it to shock and excessive pressure.

### FCC certification

This device complies with Part 15 of the FCC Rules. Operation is subject to the following two conditions:

- This device may not cause harmful interference.
- This device must accept any interference received, including interference that may cause undesired operation.

# Main Features

- 6 effects pedals built into 1 simple unit. Boost, Overdrive, Distortion, modulation, Delay, Reverb
- Full featured controls for each effect
- Built in precision guitar tuner
- Tap tempo synchronization
- Integrated effects loop for connecting external pedals or 4 cable method connection with an amplifier
- Stereo outputs
- Dedicated direct output with speaker simulation for connection to a mixing desk, computer or headphones
- Includes a carry case for easy transportation

# Pedal Layout

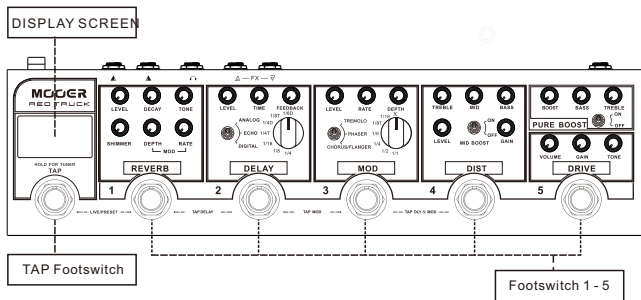

**TAP:** Press several times for tap tempo. Hold for Tuner

**Footswitch 1:** REVERB on/off in LIVE mode. Preset 1 in PRESET mode

**Footswitch 2:** DELAY on/off in LIVE mode. Preset 2 in PRESET mode

**Footswitch 3:** MOD on/off in LIVE mode. Preset 3 in PRESET mode

**Footswitch 4:** DIST on/off in LIVE mode. Preset 4 in PRESET mode

**Footswitch 5:** DRIVE on/off in LIVE mode. Preset 5 in PRESET mode

**DISPLAY SCREEN:** Displays the current operation mode of red truck. Displays the tuner when activated

# Operation Modes

Redtruck has two different operation modes. LIVE MODE and PRESET MODE  
To change operation mode, simultaneously press and release TAP + Footswitch 1

## Live Mode

In this mode Redtruck operates like a traditional pedalboard. Each footswitch will switch it's respective effects module on and off.

The **DISPLAY SCREEN** will display <L> when in Live Mode

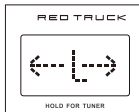

## Preset Mode

In this mode Redtruck operates like a pedalboard loop switcher. Each footswitch will recall a preset combination of which effect modules are on/off.

The **DISPLAY SCREEN** will display <P> when in Preset Mode

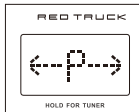

### To create a preset:

- 1.Ensure Redtruck is in LIVE MODE
- 2.Activate the effect modules you want to use in your preset
- 3.Press and hold the corresponding footswitch where you wish to save the preset for use in Preset mode
- 4.The Footswitch light will flash 5 times to confirm that the preset has been saved to this footswitch
- 5.After you have saved your presets, put the Redtruck into PRESET MODE and press any footswitch from 1-5 to recall it's preset.

*Note: Effect parameters can not be stored to the presets. Only the on/off state of each effect module will be stored.*

# Effect Modules

Red truck has 6 stompbox style effect modules and a built in precision tuner.

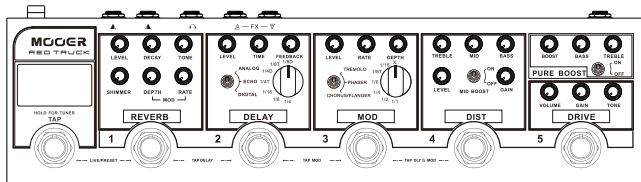

**1. PURE BOOST:** Based on one of MOOER's most popular and useful micro pedals. The Pure boost is an analog circuit which can provide up to +20 Db of clean boost with a natural and dynamic response to the touch.

**ON/OFF:** Switches the boost effect on and off

**BOOST:** Adjusts the over all amount of boost

**BASS:** Adjusts the low frequencies  $\pm 15\text{db}$

**TREBLE:** Adjusts the high frequencies  $\pm 15\text{db}$

**2. DRIVE:** Based on the MOOER RUMBLE DRIVE, the DRIVE module of Red truck is a warm and natural analog overdrive circuit. At higher gain it can emulate a vintage amplifier being pushed into breakup. At lower gain settings settings it is perfect for pushing the DIST module for solos or as a warm boost for the guitar.

**VOLUME:** Adjusts the output level

**GAIN:** Adjusts the amount of overdrive

**TONE:** Adjusts the EQ. Clockwise is brighter, Counter clockwise is darker

**3. DIST:** A classic British style amplifier distortion with full tone stack, independent gain and level controls. The gain ranges from a slight crunchy breakup to a full and harmonically rich high gain saturation.

**TREBLE:** Adjusts the high frequencies

**MID:** Adjusts the middle frequencies

**BASS:** Adjusts the low frequencies

**LEVEL:** Adjusts the overall output level

**MID-BOOST:** Boosts and scoops the middle frequencies

**GAIN:** Adjusts the amount of distortion

**4. MOD:** A digital multi-modulation unit which brings together tremolo, phaser, chorus and flanger.

**LEVEL:** Adjusts the modulation effect mix

**RATE:** Adjusts the modulation effects speed

**DEPTH:** Adjusts the modulation intensity

**Toggle switch:** Selects the modulation effect type

**Rhythm Knob:** Adjusts the speed of the modulation effect in relation to the tap tempo. (X = random 7s pattern)

**5. DELAY:** A digital delay unit with 3 different kinds of delay. DIGITAL resembles the crystal clear delay racks of the 80's. ECHO resembles the magnetic drum delays of the 60's. ANALOG resembles a classic BB style delay stompbox.

**LEVEL:** Adjusts the volume of the delays repeats

**TIME:** Adjusts the delay time

**FEEDBACK:** Adjusts the number of repeats

**Toggle switch:** Selects the delay type

**Sub-division knob:** Adjusts the delay time in relation to the tap tempo

**6. REVERB:** A true stereo digital reverb unit

**LEVEL:** Adjusts the wet/dry mix of the reverb

**DECAY:** Adjusts the length of the reverb

**tone:** Adjusts the EQ of the reverb

**SHIMMER:** Adds a high pitched shimmering harmony to the reverb.

When fully counter-clockwise the shimmer effect will be off. Rotating this control clock-wisewill gradually add shimmer to your reverb.

**MOD DEPTH:** Rotate clockwise to add modulation to your reverb and adjust the reverb modulation's depth. When this control is fully counter-clockwise the reverb will not have any modulation

**MOD RATE:** Adjusts the speed of reverb modulation effect

**TUNER:** Red Truck has an accurate built-in guitar tuner. Hold down the TAP foot switch to mute your output and activate the tuner. Press the TAP foot switch once to exit the tuner and un-mute your output.

# Tap Tempo

**TAP:** Press and release this foot switch several times to create a Tap Tempo.

Tap tempo can control both the delay time and modulation rate simultaneously or either of these two effect modules independently. The light surrounding the TAP foot switch will illuminate a different colour to indicate what it is controlling. You can change the tap tempo function by pressing a combination of two foot switches simultaneously. See below.

**DELAY + MOD = Purple** (press foot switches 3 + 4)

**DELAY only = Red**(press foot switches 1 + 2)

**MOD only = Blue** (press foot switches 2 + 3)

By default the tap tempo will control both the delay time and the modulation rate simultaneously. The TAP foot switch light will illuminate purple to indicate this.

## USING THE FX LOOP

Redtruck comes equipped with an integrated, transparent, buffered effects loop. This sits between the DIST and MOD modules in the internal signal chain. The FX LOOP can be used in many different ways, making the Redtruck a true "swiss army knife" of a pedal. Here's a few of our favourites.....

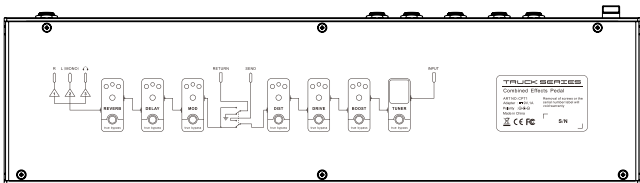

**SEND:** Can also be considered as DIST output

**RETURN:** Can also be considered as MOD input

### -Add your favourite pedal or preamp to the chain -

This is an easy way to add an extra pedal into the Redtruck signal chain, right in-between your DIST and MOD.

Connect **SEND** to the input of your favourite pedal. Connect the output of the pedal to the **RETURN** of Redtruck.

We like to use this with our Micro Preamp pedals for the ultimate in portable rigs.

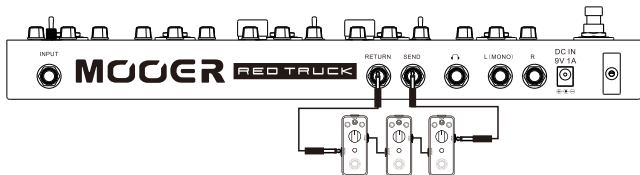

### - 4 cable method -

If your amplifier has it's own effects loop you can connect the Redtruck using the "4 cable method" which will put the drive modules in front of your amplifiers input and the modulation, delay and reverb modules into your amplifiers effects loop.

- Connect your guitar to the input of your red truck
- Connect **SEND** of the Redtruck to your amplifiers input
- Connect your amplifiers "effects send" to the Redtruck **RETURN**
- Connect the **OUTPUT** of Redtruck to the "effects return" of your amplifier

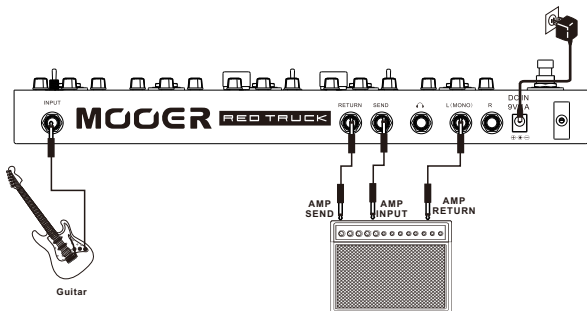



## - WET DRY SETUP -

This is an easy way to setup Redtruck with 2 amplifiers. One amplifier with just the drive signal. The other amplifier with drive signal, modulation, delay and reverb effects. This is a very popular setup method used by professional guitarists to maintain astonishingly clear and articulate tones while still having beautiful atmospheric effects for live shows. To accomplish this setup you will also require an ABY box. We recommend the MOOER ABY mkII

- Connect your guitar to the input of Redtruck
- Connect **SEND** of the Redtruck to the input of your ABY box
- Connect one output of the ABY box to the input of AMP Dry
- Connect the other output of the ABY box to the **RETURN** of Red truck
- Connect the **OUTPUT** of Redtruck to the input of AMP Wet L (see diagram)

If you have a 3rd amplifier you can use both stereo outputs of Redtruck to make a WET DRY WET setup taking full advantage of a big, wet, true stereo reverb, whilst maintaining an awesome clear guitar tone.

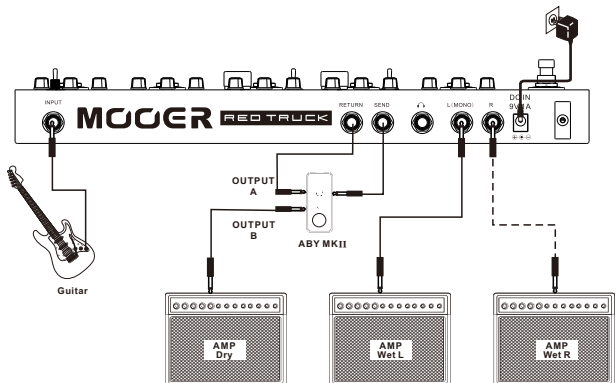

# CONNECTIONS

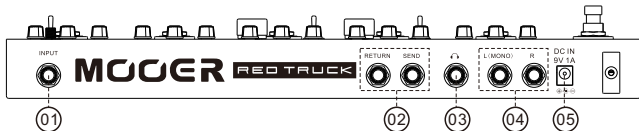

## 1. INPUT

Connect your instrument to this input using a standard 1/4" jack cable

## 2. FX LOOP

Refer to the 'USING THE FX LOOP' section of this manual for more details

## 3. CAB SIM OUTPUT

Connect to this output using a mono or stereo 1/4" jack cable. This provides an output with integrated speaker cabinet simulation for connecting headphones or Direct to your PA system or recording console

## 4. OUTPUT

Connect to these outputs using standard 1/4" Jack cables

Connect to L only for mono output

Connect to L and R for true stereo output

## 5. DC IN $\oplus$ $\ominus$ 9V1A

Connect your power supply to this input

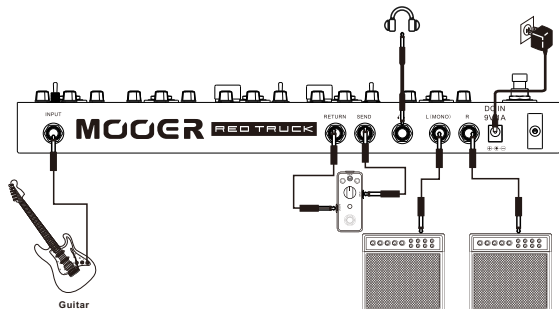

# Technical Parameters

**Input:** 1/4" signal input audio interface (impedance 2M ohms)

**Output:** 1/4" left and right channel audio interface x2 (impedance 100 ohms)

**Sampling rate:** 44.1K

**Sampling accuracy:** 24bit

**Power supply:** DC 9V1A power adapter 

**Size:** 370 mm (D) X 96 mm (W) X 51 mm (H)

**Weight:** 1200g

**Attachment:** Owner's Manual , Carry Case

*\*Disclaimer: Parameter update is subject to change without notice.*

**MOOER**

---

MOOER AUDIO CO.,LTD

[www.moeraudio.com](http://www.moeraudio.com)

**Part No:620010629**