

COCKPIT²



Flight plan 1.0

First things first

RTFM – be so kind and read the manual. It will provide you with the information you need to fully indulge in the module you just purchased – for which we like to thank you.

Enjoy your sound experiences, dear sonic traveller.

Beginning from the product's purchase date a 1-year warranty is guaranteed for each product in case of any manufacturing errors or other functional deficiencies during runtime.

The warranty does not apply in case of:

- damage caused by misuse
- mechanical damage arising from careless treatment (dropping, vigorous shaking, mishandling, etc.)
- damage caused by liquids or powders penetrating the device
- heat damage caused by overexposure to sunlight or heating
- electric damage caused by improper connecting

Visit us:

<http://endorphin.es>

[@endorphin.es](#)

<http://youtube.com/user/TheEndorphines>

<http://facebook.com/TheEndorphines>

Drop us a line:

support@endorphin.es

FURTH BARCELONA, S.L.

VAT ID:ES B66836487

COCKPIT² OPERATED BY ENDORPHIN.ES AIRWAYS



READY FOR TAKE-OFF

- 6 HP width, up to 1 1/2" in depth – super slim and SHUTTLE friendly
- 4 stereo channel performance mixer – the missing link in the 84 HP SHUTTLE system
- Connect your desktop synthesizers/iPad/drum machine/mp3 player to be mixed altogether with the rest of your modular gear
- On-board compressor with external sidechain control to add proper dynamics or ducking to your mix
- Stereo output for speakerphones or headphones with enough current to drive a wide range of headphones
- Prepared for the "Cockpit Expander" module to use send/return functionality and more

WELCOME TO THE NEW ENDORPHIN.ES – COCKPIT!

The COCKPIT is a four stereo channel performance mixer.

Each channel accepts either a stereo or mono, either modular or line level. Connect all devices together for your live performance. Limited with the channels? Add another COCKPIT with the up to infinite daisy chain option without losing a channel by patching one COCKPIT into the next one. The mixer is built using analogue stereo VCAs with a smart digital control – i.e. all audio is mixed in analogue way, however the level of each channel is controlled with digital encoders (or CV for ducking).

FADERS

Everything starts at the inputs. Each channel has an input jack marked with 4 arrows pointing inside.

The encoder near each input adjusts the level on the signal. Turning it CW will make the channel's level higher and turning it CCW will attenuate the channel off to full silence. Since encoder's rotation is endless, it doesn't have a line that shows its current position to understand the level of the channel. For that reason there's a bi-colour LED near each encoder knob and the **brightness of the LED shows how high the level is**. When the **LED is green the channel is on**. Shortly pushing the encoder knob (button function), mutes the channel. When the **channel is muted, the LED colour turns red**. However, the brightness of the LED remains same as it was before and indicates the volume level also in the muted state. With this feature you can also decrease or increase the level of the channel when muted, which comes in handy, if you want to mute (push encoder) a sound at full volume, change the volume to zero (by turning CCW), unmute it (push encoder) and fade it back into the mix again (by turning CW).

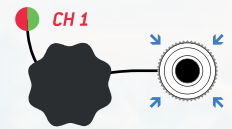

Hint: Every few seconds the position of all encoders (levels of all channels) as well some other encoder buttons enabled settings are stored into memory so after turning your modular system power off and on again you will have all the settings you had before.

MONO OR STEREO SOURCE

Usually all signals in a modular synthesizer are simple mono signals and are connected with one another by one-wire ground-shielded patch cord. Adding consumer electronics as mono or stereo sources (i.e. mp3 players, iOS or PC/MAC VST/AU synthesizers along with the hardware synthesizers, drum- and groove-boxes and finally – some eurorack modules like TipTop Audio Z-DSP, Mutable Instruments Clouds, Elements, Audio Damage modules, Endorphin.es Grand Terminal etc.), usually involves stereo signals sources as a pair tip-sleeve 3.5mm mono jacks or stereo TRS 3.5mm jacks. To equalize the modular (usually 10Vpeak-peak) and line signals (usually around 1Vpeak-peak), and also to have more headroom for mixing and less noise, modular signals are attenuated to a line-level ones. That is a straightforward task with COCKPIT – it is as easy as cranking appropriate channel's encoder a few increments CCW to decrease the level of the signal.

However let's see what happens when **mono** patch cable is plugged into a **stereo** jack.

When plugged, the right channel (ring contact) of the jack connected (literally shorted) to ground, and as a result, we listen mono source from modular synthesizer only in left channel (left speaker).

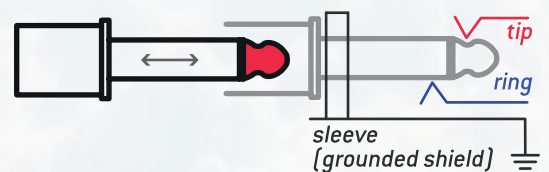

*As far as you mix **mono** signals only to obtain one final **mono** signal sausage – that is pretty much alright, however when stereo sources added, then it requires doubling the **mono** signals in both, the left and the right channel.*

For that reason there is a set of **green** jumpers on the backside of the COCKPIT – 1 jumper per channel (1 to 4). Each jumper obviously may be in two positions. For example **S-CH1-M**. When jumper connected on pins pair **S-CH1**, then the input of **channel 1 is a full stereo input** that will accept and adjust left and right channels and output them to the left and right channel of your speakerphones. However when the jumper is installed on **CH1-M** position, **channel 1 input accepts mono signals only**, ignoring the signal that may occur from the **ring** (right), and that **left** signal will appear in the left speaker and then exactly doubled in your **right** speaker (the level of this doubled signal can of course also be adjusted with the encoder).

When **no** jumper is installed, then absolutely **no right** signal from that channel (whenever stereo or mono plug inserted) will appear in your **right** speakerphone.

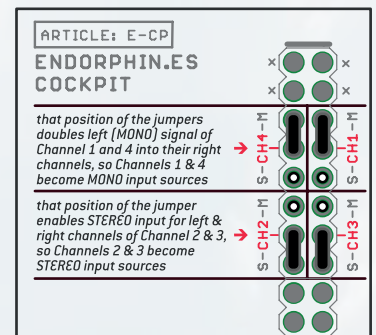

Tipp: We advise that configuration when you use all mono jacks and signals for inputs and outputs and want to use the signal furthermore within your modular setup for instance.

The COCKPIT module is designed to carry 'send' and 'return'. The release of an XPansion that puts all jumpers as toggle switches to a faceplate along with sends and returns for external processing gear, like guitar pedals or stereo effect units, is planned.

DAISY CHAIN

If 4 channels are not enough for you and you need more, you may add an/other COCKPIT/COCKPIT²(s) to your rack and connect it/them to the first one with an up to infinite daisy chain using two female/female **jumper wires** (left and right pins) as connection. Both versions (COCKPIT and COCKPIT²) are compatible. One mixer has to be **master** – its final output will go to your headphones or speakers. Another **slave** may be connected to the **master** (you may consider it as sort of a group with its own sub-mix level). The master level of the **slave** is regulated with the **blue** gain knob on the **slave** itself. After you chose its level, it will be mixed with all the channels of **master** at that level. Keep in mind you will not be able to adjust the volume of the **slave** from the **master** – the final volume of **slaves** can be adjusted on **slaves** only.

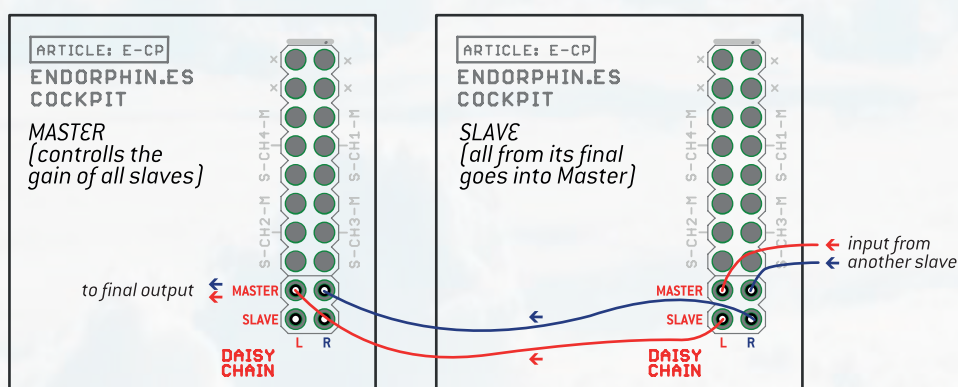

Easy to remember: SLAVE are outputs and MASTER are inputs.

DUCKING COMPRESSOR WITH A SIDECHAIN INPUT

If you are familiar with side chain ducking or pumping compressors – frequently used on the radio stations or the latest EDM hit single – it may be easier to understand what that part of the module does. **The COCKPIT doesn't include a straightforward compressor**, but more an audio ducking utility that works in a few different modes (see below).

Theory corner start: Let's see how a general-purpose compressor works. Basically what a compressor does, is attenuating the signal (closing the VCA) under incoming CV to make the incoming audio signal dynamically equal (e.g. higher amplitudes to be lowered to average ones). CV is extracted from that audio signal with the algorithm to analyse the peaks (or better say RMS level). Before passing into the VCA, that audio signal is split: The sidechain signal is passed through the envelope follower (with adjusted attack and decay levels for the slew limiter) to extract the CV from the audio and then that CV is mixed (decreased proportionally) from the CV input that controls the level of the VCA through which the actual audio signal is passing. That proportional amount of CV applied may be considered as 'ratio'.

Of course, instead of CV, extracted from the envelope follower, any other CV may be applied. It is easy to connect an envelope generator – into what is called 'sidechain' input of the compressor.

In techno music one effect with compressor is used intentionally. That's when the bass or synth arpeggio are ducked (attenuated) every time the kick drum is appears. At sharp (instant) kick drum's attack, the level of synth is immediately decreased. While the kick drum is decaying, the synth line returns to a normal volume and then is decreased again at the next hit of the kick. So far, the amplitude of the bass line/arpeggio synth is variable, or let's say being modulated in a very synchronous way – creating a **pumping/ducking effect**.

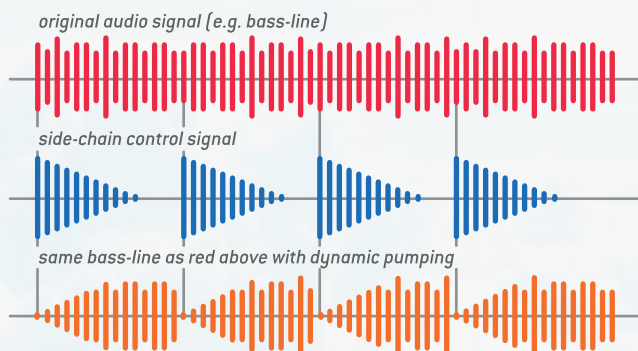

The kick drum passed via envelope follower usually generates a CV that is similar to what an envelope generator delivers. Also, adjusting the attack and decay times and the shapes of an envelope (as the Airplanes of the Terminal and Grand Terminal are able to), may recreate the same behaviour of an envelope CV from a kick drum. All we need to do is to apply the envelope generator into the sidechain input and adjust the level of influence. **Theory corner end.**

The sidechain compressor of the COCKPIT can work in three different modes. Each mode involves a different approach, and might be chosen, depending on the modules or tools you wish to use, or which result you're up to.

When you press all four encoder buttons (CH 1-2-3-4) simultaneously and hold them for longer than 1 second, you switch to the next mode, one by one. You will notice that the blue LED will blink as many times, as the number of the mode it is set (1, 2 or 3 consequent blinks). The currently selected mode is saved during module's power off and when you turn on the power of your modular system, you will notice same amount of blinking times that states the currently selected sidechain mode.

1. Ducking with CV: The input of the COCKPIT accepts unipolar CV from 0 to approximately +5V. Everything that goes above +5V is being saturated, and everything that is below zero will be cut off.

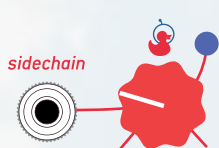

To enable **ducking** on a channel, just press and hold the encoder's button for more than 1 second. After that you will immediately see the channel LED will strobe/blink (with the inverted colour of the actual channel's state – enabled > red or muted > green – so if the channel is enabled and its LED is green, then once per few seconds that LED will blink with a very short red light). To disable the ducking for that channel, simply hold its encoder's button again for more than 1 second.

[Short press on encoder button will do the mute/unmute job, and long press will enable/disable the ducking on that channel.]

The red knob (the one with the **duck** icon) adjusts the level of ducking. Adjust it to the desired pumping level/intensity. The blue LED near that knob shows the amplitude of the input signal and lights up when the ducking level increases.

TIPP: When **no plug** is inserted into **sidechain** jack, then the sum of all four channels is sent to the sidechain input of the ducking compressor. That connection may seem a bit experimental (since the channel generates envelope CV being ducked afterwards by its own that may sound as amplitude modulation), however at some point may bring interesting results.

2. Ducking with audio: In that mode the sidechain input is amplified in approx. 10 times with an envelope follower at the input. Now you may simply input a sound source (a kick or snare drum for instance – at a consumer line level – approx. 1Vpp) and the CV will be extracted from that audio source and applied to the channels you assigned to the ducking by pressing-and-holding the encoder for over one second (just as you did in the CV in mode described above).

Tip: If the ducking effect seems too hefty, it may be, that the audio you want to use is too 'hot' – attenuating may help.

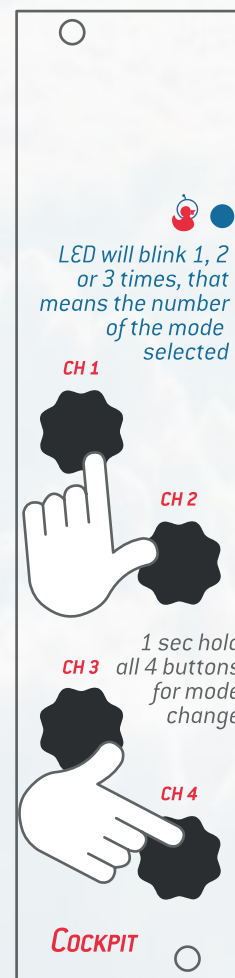

3. Ducking with triggers: In that mode sidechain input accepts triggers in standard modular level (everything that is higher than 1V is recognized as **on** and lower than 250mV as **off**). Every trigger generates internal envelope (falling ramp) in the COCKPIT. That envelope has instant (zero) attack and the decay time is defined by the red knob with the duck icon above. Time of decay varies from 10ms to 10 seconds and at full CCW knob position there is no effect applied.

To enable sidechain control on a certain channel, you have to press and – while pressing – rotate black knob/encoder of a the channel you want affected by the ducking. While pressing and holding you may notice that LED near certain knob will light up orange (which is basically a mix of the green and red light) and the brightness of orange LED will state the amount of ducking applied. After you release the black knob, that LED will become again either green (if that channel is on), or red (if channel is muted) with previously defined volume (brightness of the LED).

Tipp: The third mode is useful, when you don't have any spare envelope or audio source, but have a clock, or rather like working with complex clock patterns than with envelopes or audio. It may also be derived from almost any drum machine as MIDI-clock (transformed into PPQN/24 pulses), or from a separate audio output.

RHYTHM COMPOSER

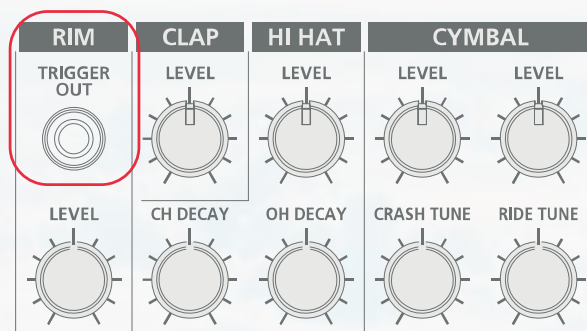

mode	number of blinks	sidechain input	compression controls
1	●	0 ... +5V CV	<ul style="list-style-type: none"> To enable the channel to be under sidechain control, long hold CH 1-4 black knobs. The LED near that knob will start to blink approximately once per second . Red knob defines the amount of influence of the CV applied.
2	●●	1Vpp audio	<ul style="list-style-type: none"> Same as mode 1, however sidechain input accepts line-level audio signal (mp3 player, iPad, iPhone etc.) and internal envelope follower is applied to that signal. Red knob defines the amount of influence of the CV applied.
3	●●●	0 ... +5V clock	<ul style="list-style-type: none"> Sidechain input accepts clock/triggers. COCKPIT generates falling RAMP under incoming trigger and red knob defines the time of decay. At full CCW position no ducking is applied. By pressing and turning CH 1-4 knobs, you adjust the influence level of compressor to a certain channel separately.

FINAL OUTPUT

The mix of all four channels (including daisy-chained channels, if connected) pass to the final output, which is a 3.5 mm stereo jack.

The blue knob adjusts the level of the output, from the full silence when CCW or high gain output at full CW state. That is a high current output capable of driving a wide range of headphones or connecting your monitors directly (with stereo TRS 3.5 mm 1/8" to two mono XLR or 1/4" TS plugs so you may plug into a concert mixer/amplifier or pass the signal to another module).

You may use stereo 3.5 mm cable splitters to pass the signal to different sources. For example you may record audio into your DSLR camera directly with 3.5 mm stereo aux cable while monitoring the sound in your speakerphones.

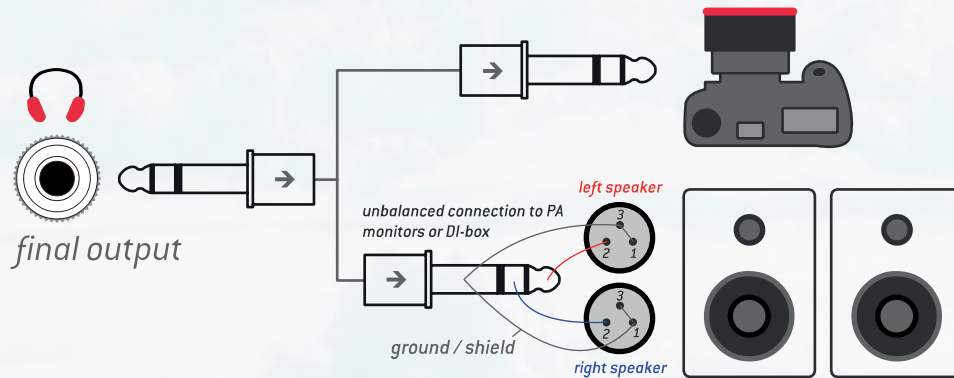
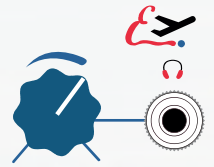

That output has a short-circuit protection which means you may plug a mono cable there. Still, with that mono connection the right channel's output will be shorted to ground (see 'MONO OR STEREO SOURCE' paragraph above) but the module is able to withstand that. However, that may also cause extra current consumption and generating extra heat.

Just as with GRAND TERMINAL, we include 3.5mm TRS STEREO PLUG into two separate LEFT and RIGHT TS MONO adapter, so you may route the signal to your mixer, PA monitors or other mono/stereo modules in your rack easier:

