



Assembly Manual



HOME BIG

1

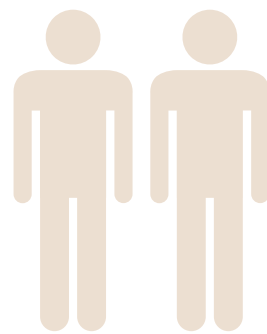
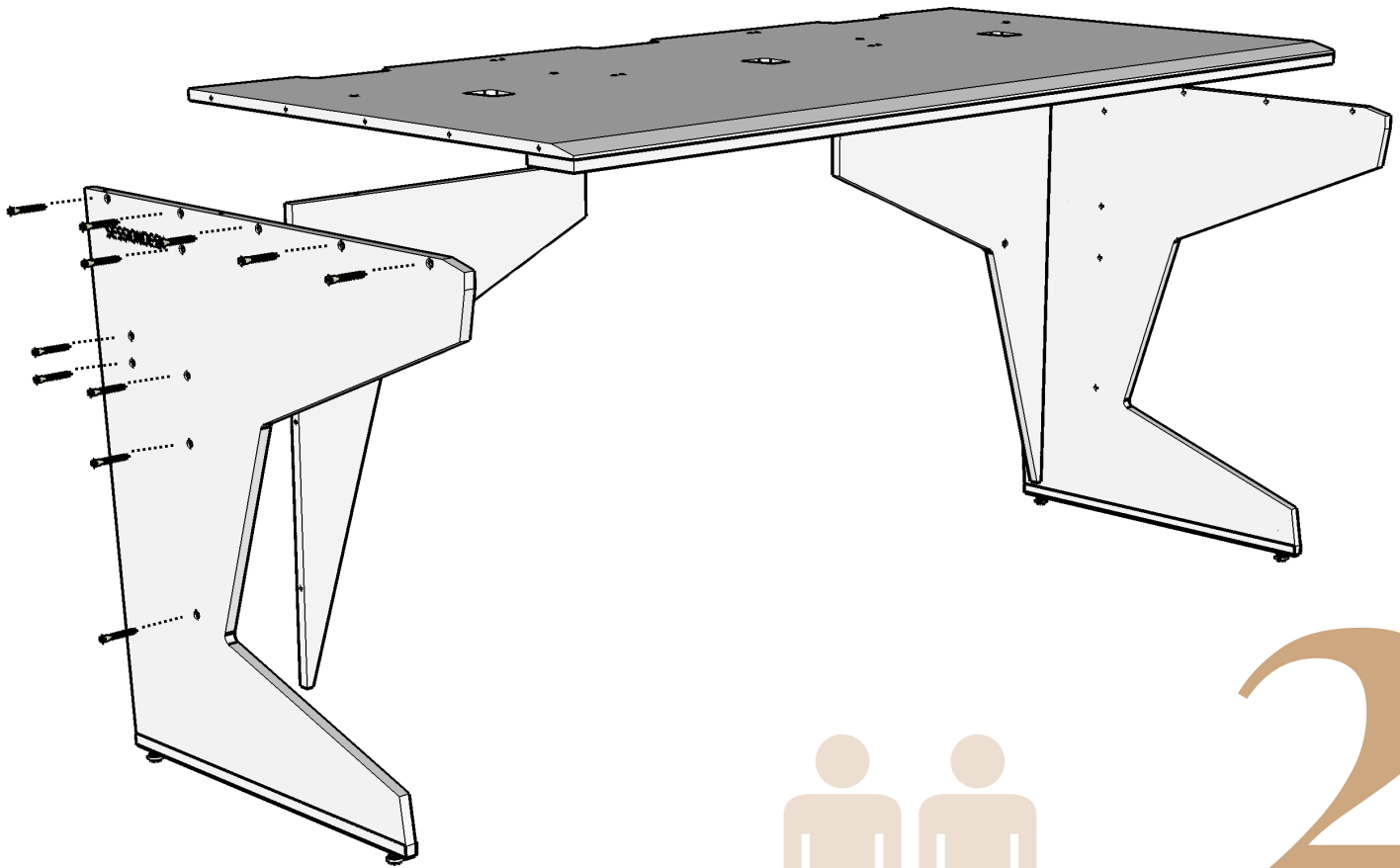
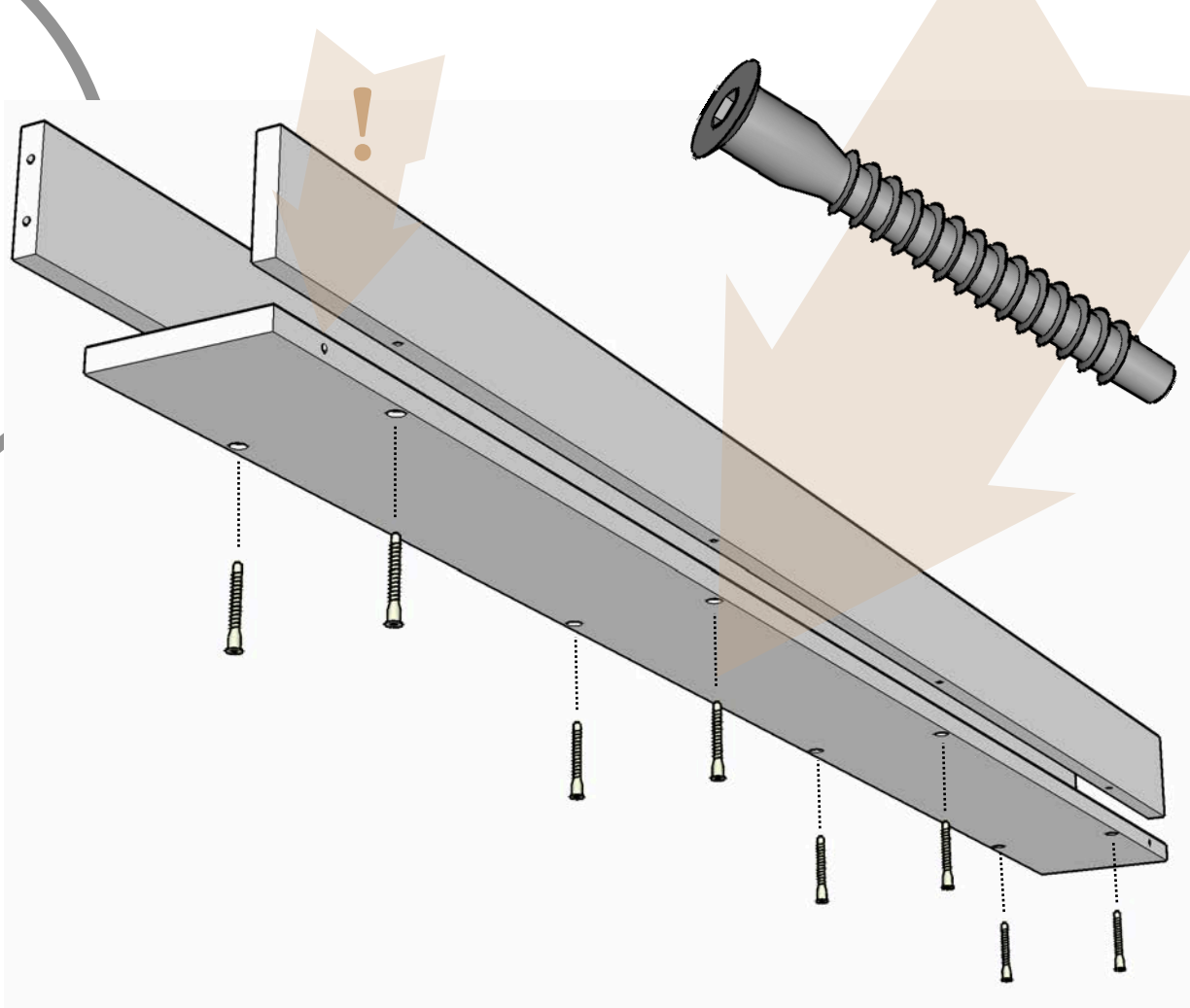

2

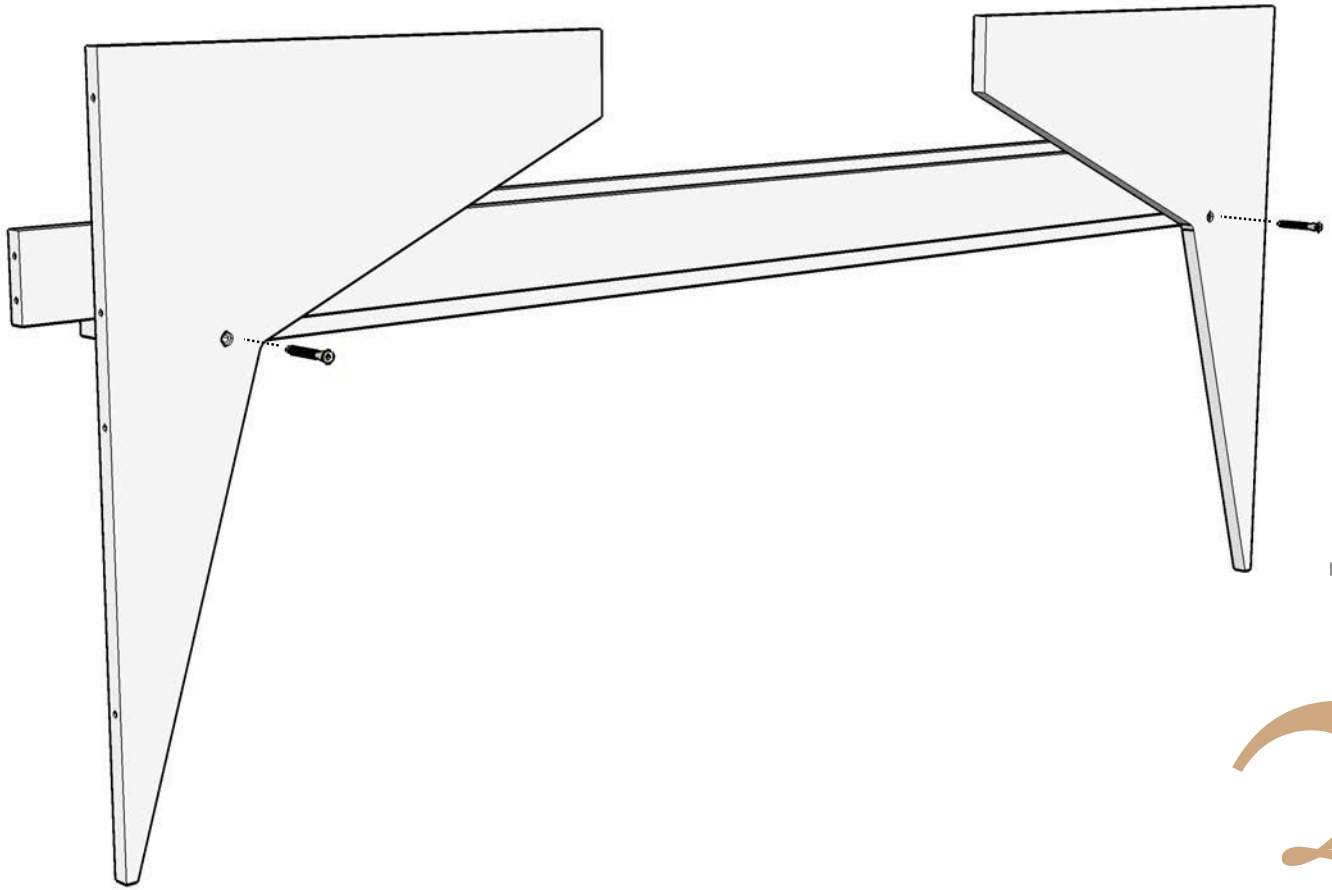

3

4

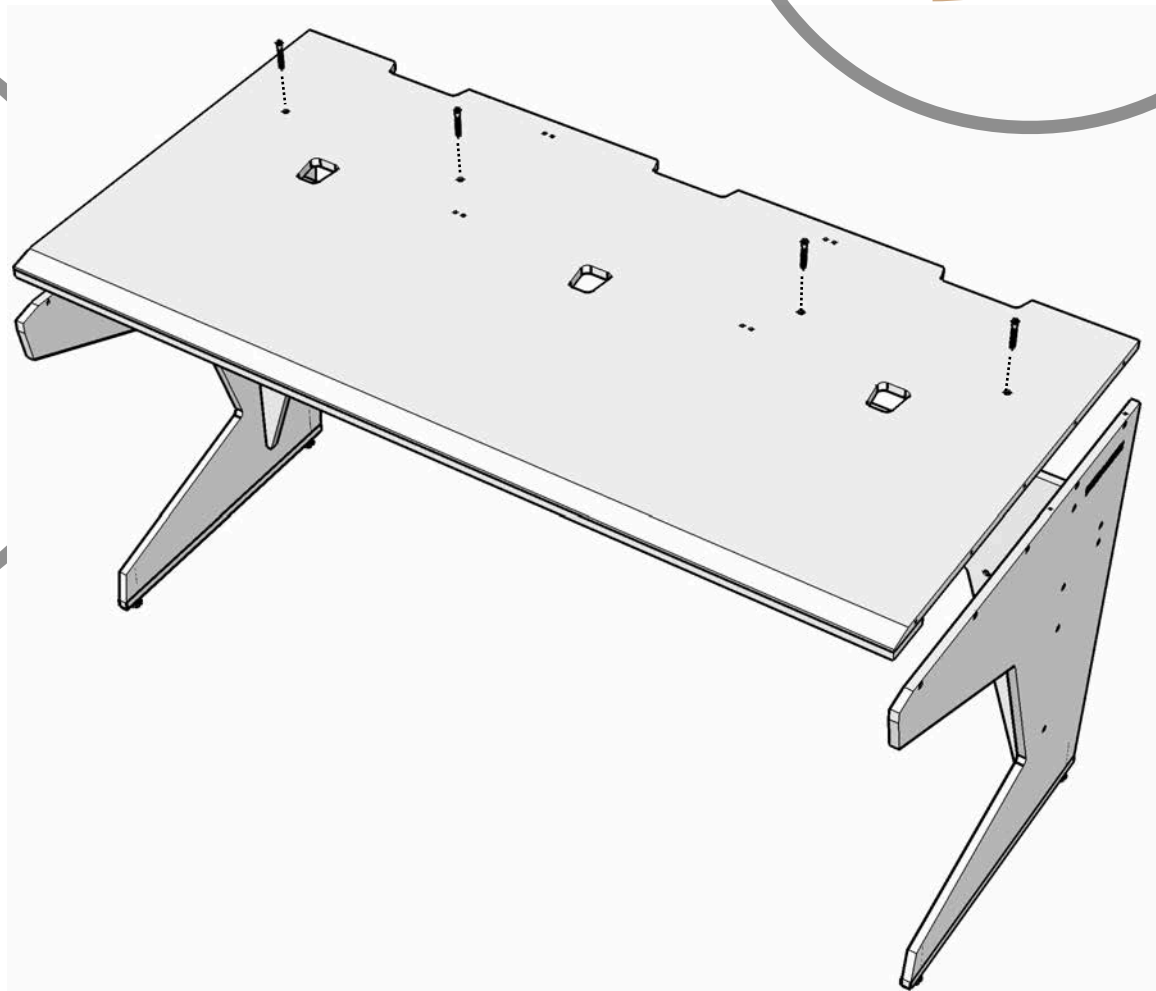

5

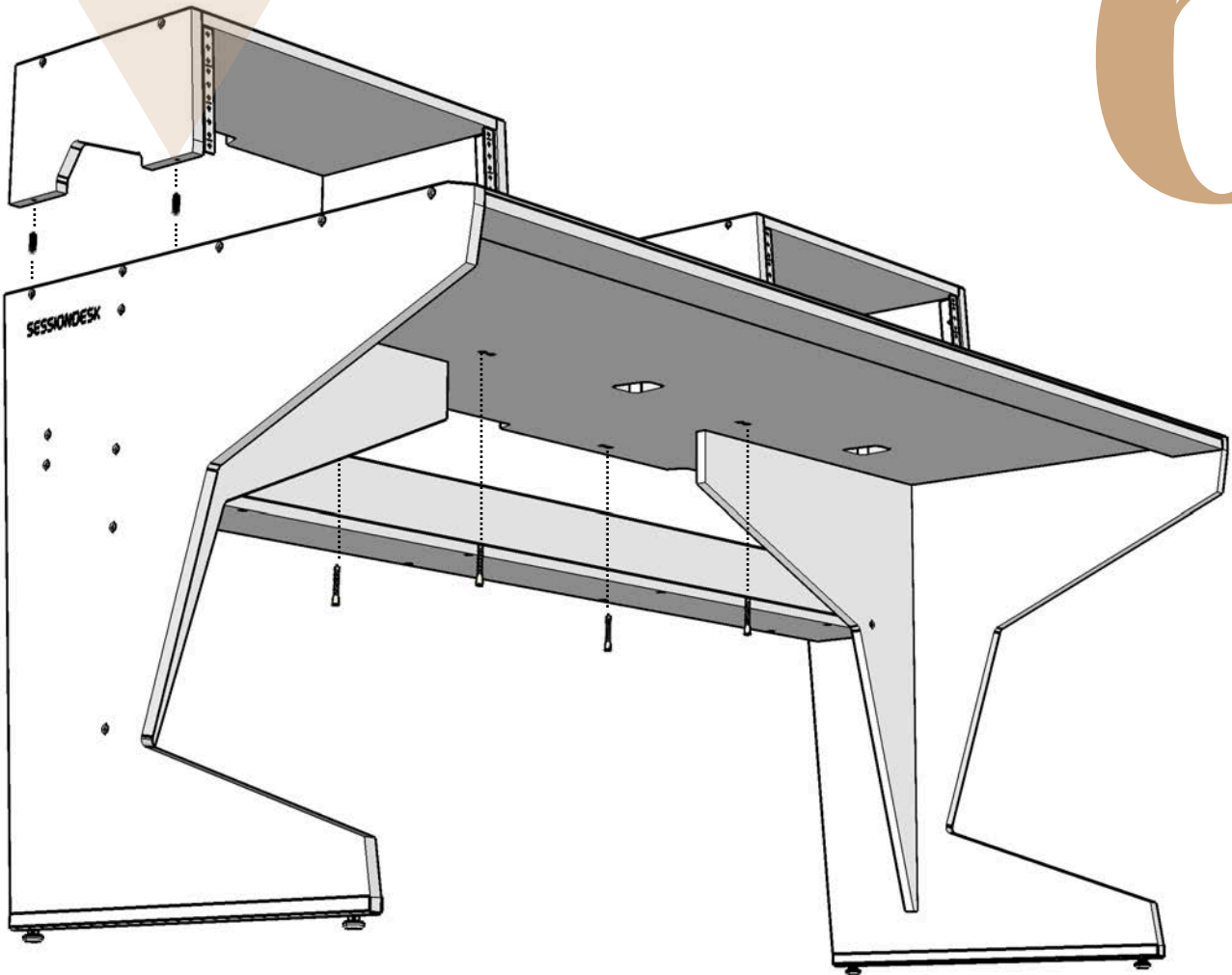
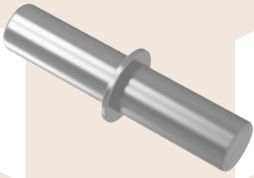
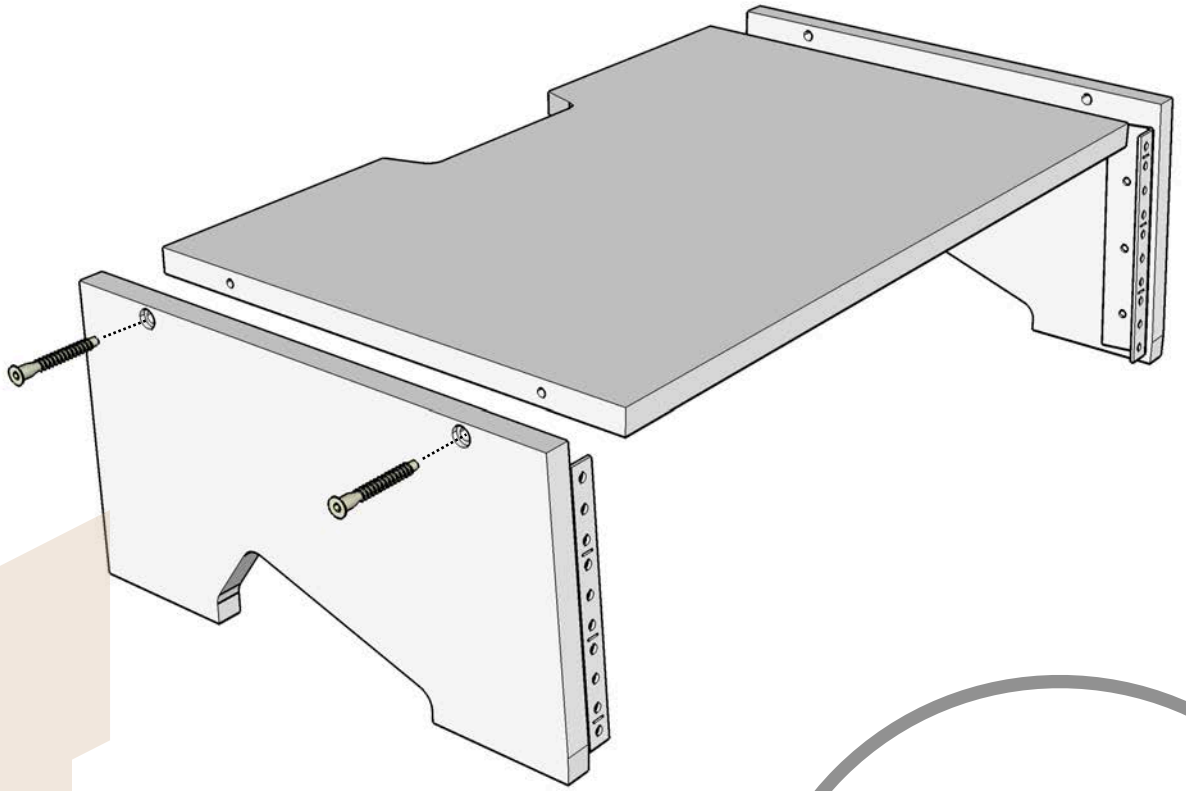

6

7

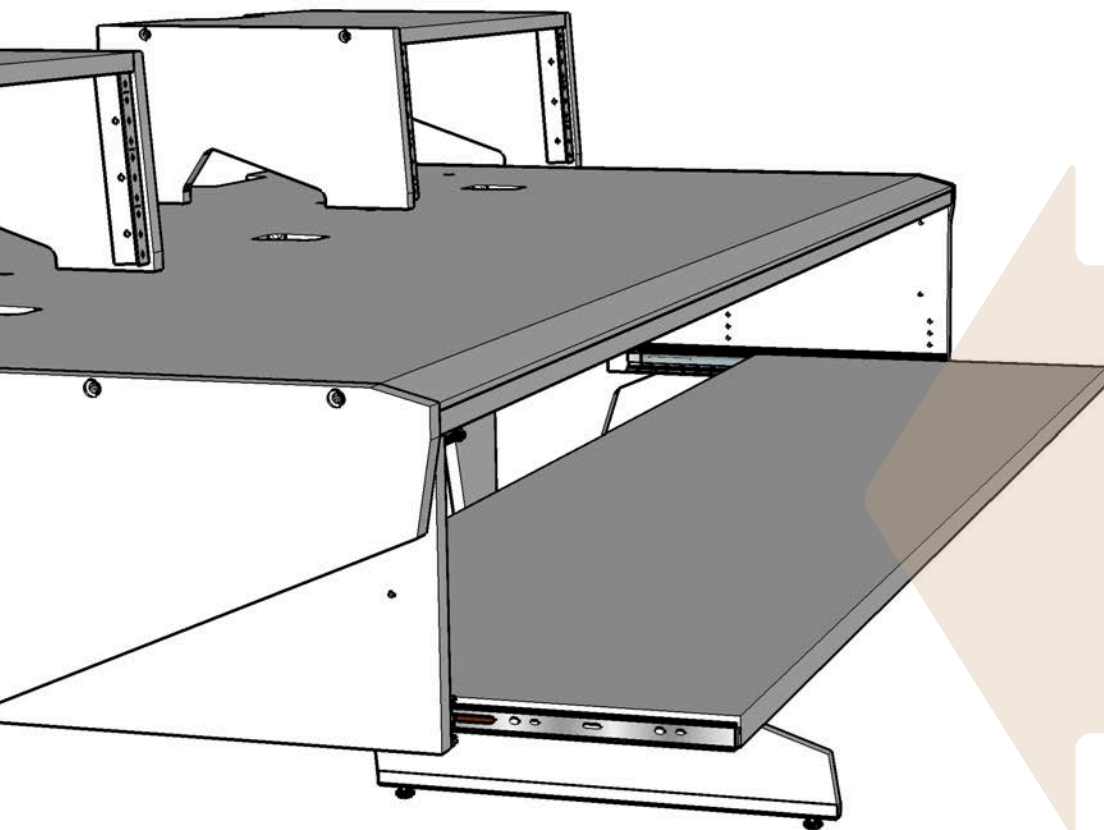
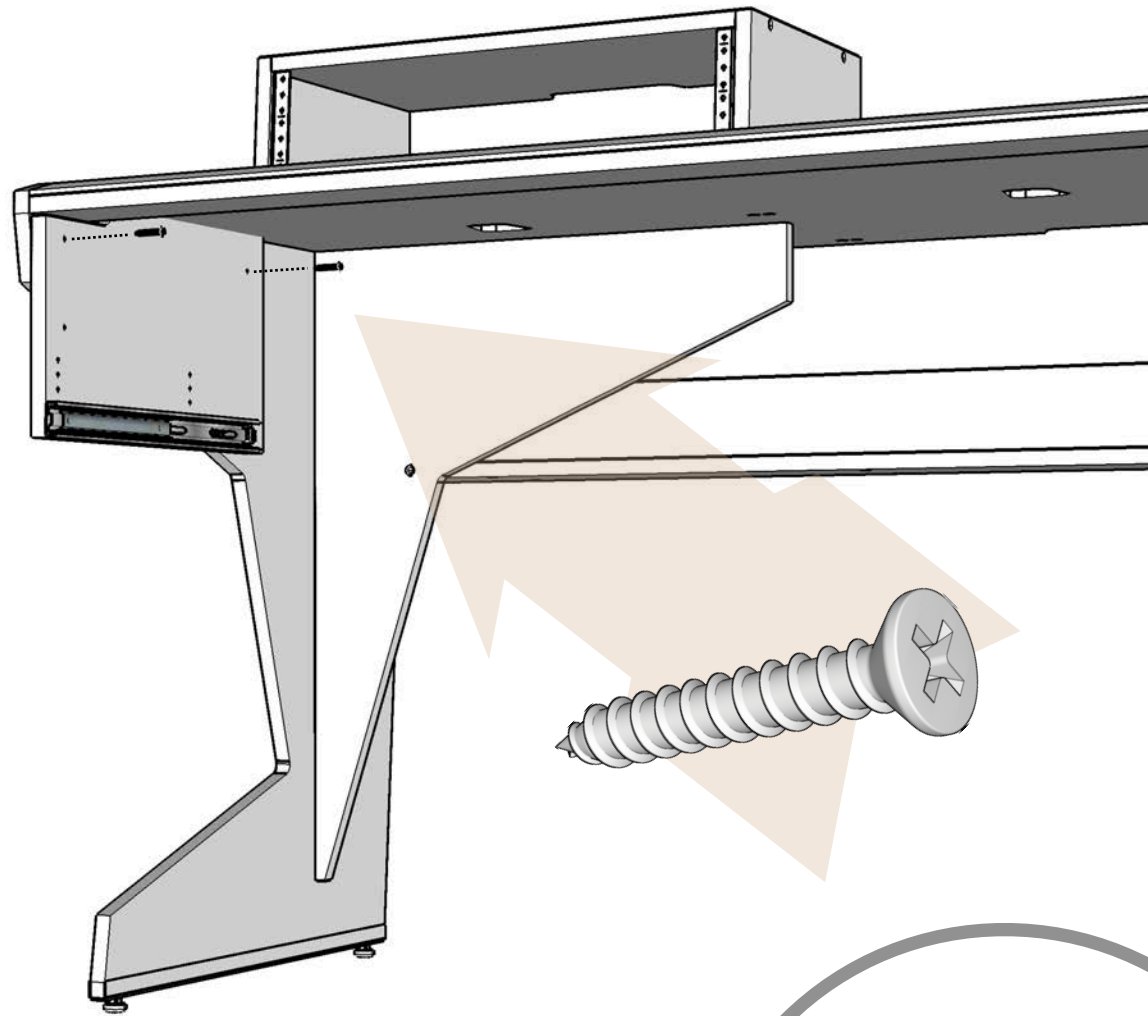

8

9

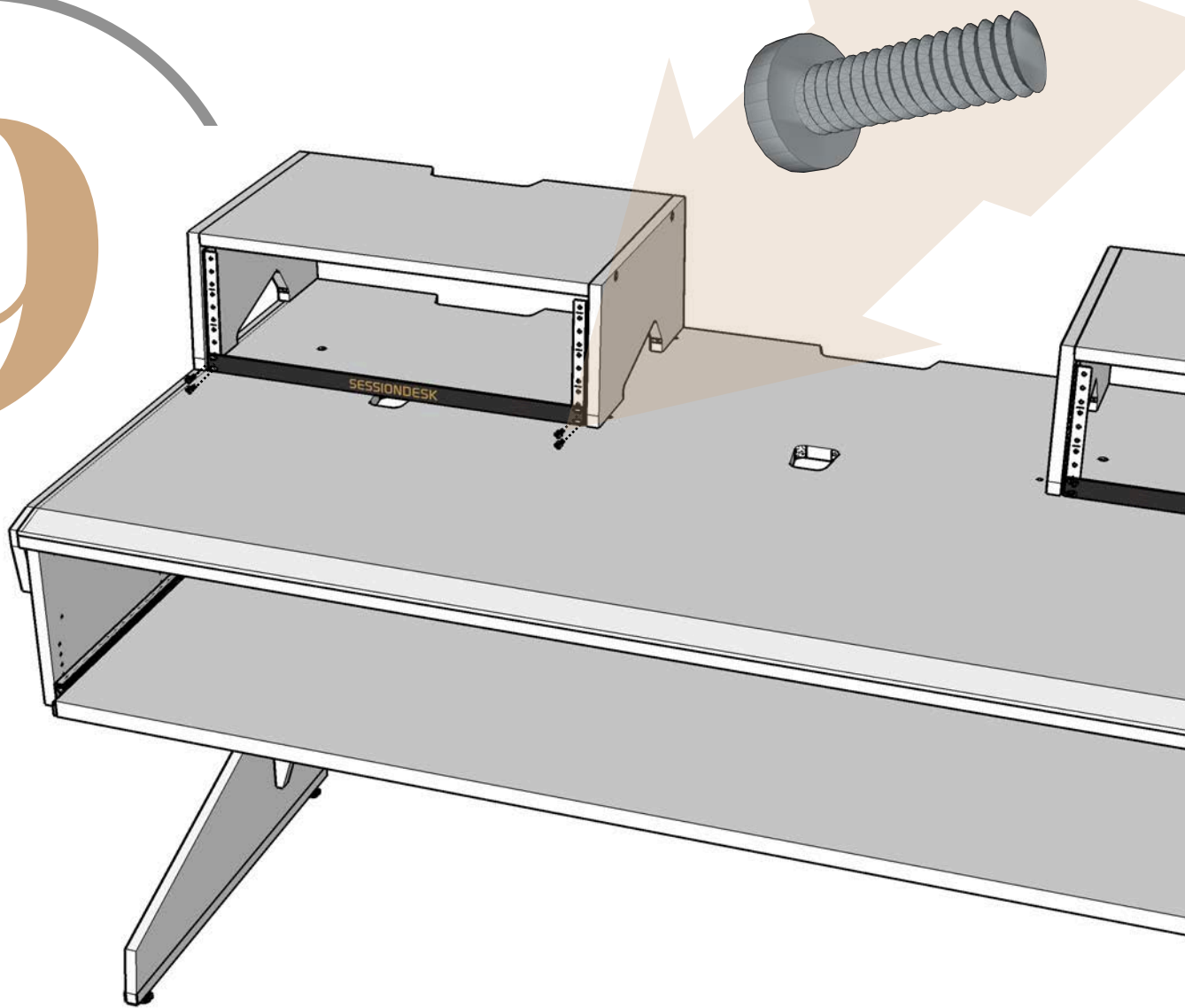

SESSIONDESK[®]
designed by audio engineers

www.sessiondesk.com
contact@sessiondesk.com

Follow us on our channels:
facebook.com/sessiondesk
instagram.com/sessiondesk
[Youtube Channel](#)

© 2022 All rights reserved