

nanobox | razzmatazz



User Manual V. 1.1.0

Oct 14, 2022

1010 music

Copyright 1010music LLC 2022

WELCOME	8
GET SET UP	9
SET UP THE HARDWARE	9
GET THE LATEST FIRMWARE	10
FIND YOUR WAY AROUND	11
BASIC CONTROLS	11
THE TELEPORTER	12
PADS SCREENS	13
WAV MANAGEMENT SCREENS	14
SEQUENCER SCREENS	14
KIT PRESETS	15
MANAGE PRESETS	16
Load a Preset	16
Save a Preset	16
Save As a New Preset	17
Create a New Preset	18
Rename a Preset	18
Delete a Preset	18
PLAY THE PADS	19
FINGER DRUM	19
PLAY WITH A MIDI CONTROLLER	19

TWEAK THE SOUND WITH MACRO CONTROLS	20
Common Macro Controls	21
Macro Controls for Clip and Slicer Pads	22
Macro Controls For Each Model	23
SEQUENCES AND TRANSPORTS	24
START AND STOP A SEQUENCE	24
THE TRANSPORTS POP-UP	25
Set the Tempo	26
Adjust the Swing	26
Enable the Metronome	27
Record a Sequence	27
EDIT SEQUENCES WITH THE SUPER STEPPER	28
BASIC WORKFLOW FOR SEQUENCE CREATION	28
CREATE & EDIT SEQUENCES	29
Set Sequence Step Length and Step Count	29
Create and Edit a Sequence with the Super Stepper	30
Edit Velocity of Pad Trigger Events	31
Copy, Paste, Clear and Extend Sequences	32
MIXING AND MUTING	33
CONTROL THE MIX	34
MUTE A PAD	35
BUSSED AND GLOBAL EFFECTS	36
NAVIGATE TO THE FX SCREENS	37

CONFIGURE EFFECT BUSSES WITH THE FX SENDS SCREEN	38
CONFIGURE EFFECT SENDS FOR THE LINE INPUT	39
FX VOICE ARCHITECTURE	39
ADJUST FX SETTINGS	40
FX1 - Delay Settings	40
FX2 - Reverb Settings	41
FX3 - Cabinet Distortion	42
CRAFT YOUR OWN SOUND	44
NAVIGATE AROUND THE PAD DASHBOARD	45
PAD MODELS	46
Available Models	46
How to Select a Pad Model	47
THE PAD DASHBOARD	48
FM OSCILLATOR SOUND SOURCES	49
Configure the FM Oscillators	49
FM Oscillator Parameters	50
THE WAV SOUND SOURCE	52
Add or Change a WAV File Mapping	52
Edit WAV Settings	52
WAV Parameters	53
Record a WAV	54
Remove a WAV from a Pad	55
PAD PITCH CONTROLS	55

FILTERS	56
Adjust Filter Settings	56
Filter Parameters	57
ENVELOPES	58
Adjust Envelope Settings	58
Envelope 1 and 2 Parameters	59
LOW FREQUENCY OSCILLATOR	60
Adjust LFO Settings	60
LFO Parameters	61
DRUM EFFECTS	62
Adjust DFX Settings	62
DFX Parameters	63
PAD SETUP OPTIONS	65
Choose Pad Setup Options	65
Available Pad Setup Options	66
CLIPS AND SLICERS	67
Pad Dashboard for Clips and Slicers	67
Clip Features	68
Clip File Requirements	68
Slicer Features	69
Slicer File Requirements	69

MANAGE PADS	70
Copy and Paste a Pad	70
Change a Pad Label	71
Save and Load Pads from the Pad Bank	72
Delete Files from the Pad Bank	73
VOICE ARCHITECTURE	74
SERIAL FILTER MODE	74
PARALLEL FILTER MODE	75
PER OSCILLATOR FILTER MODE	76
CLIP AND SLICER MODE	77
NANOBOX CONFIGURATION SETTINGS	78
FIRMWARE VERSION	78
AVAILABLE NANOBOX SETTINGS	78
USING A MIDI CONTROLLER	80
MIDI HARDWARE CONNECTIONS	80
MIDI SETTINGS	81
MIDI NOTE MESSAGES: PLAY THE PADS	81
MIDI CONTROL CHANGE: CONTROL YOUR SETTINGS	82
Map MIDI CC Numbers to razzmatazz Settings with MIDI Learn	82
Clear a MIDI Mapping to a Control	83
MIDI PROGRAM CHANGE: LOAD NEW KIT PRESETS	83

MIDI ALL NOTES OFF: CLEAR STUCK NOTES	83
SYNCHRONIZE WITH AN EXTERNAL CLOCK	84
USE MODULATION TO VARY SETTINGS	85
WORK WITH THE MICRO SD CARD	86
BACK UP YOUR FILES	86
MANAGE WAV FILES	87
SHARE PADS & PRESETS	88
UPDATE FIRMWARE	89

WELCOME

Create the juiciest beats and tastiest rhythms with **nanobox | razzmatazz**, a mini drum sequencer that combines powerful FM synthesis and sampling. Featuring an advanced voice architecture, razzmatazz puts a huge range of percussive sounds at your fingertips—from deep and gritty kick drums to searing snare hits and crisp hi-hats. Perform using 8 touchscreen pads or your favorite MIDI controller, and craft up to 16 rhythms using an innovative visual sequencer that allows you to see all pad states and steps simultaneously. Shape the sound of each pad by combining any variation of two FM oscillators and a WAV file—plus two filters, two envelopes, a resonator, a snap generator, and three additional effects. You can even choose from four unique types of distortion to create incredibly distinct and powerful drum sounds. Enjoy massive analog drum sounds and an innovative feature set, all in a compact package that goes anywhere.

This user manual will walk you through the full set of features and capabilities of the razzmatazz. If you want to get up and running quickly, take a look at the 4 page Quick Start Guide available on the 1010music product support page.

To get started, we will walk you through the simple process of setting up the razzmatazz and then make sure the version of firmware you are running is the same one covered in this manual. Chances are there is already a newer version of the firmware than what came installed on your unit. Upgrade now to get the latest set of features.

The User Interface Map will give you a road map to explore. Then we will cover basic preset management so you know how to explore the sounds available and save any changes you make. Then we can dive into playing pads, sequencing, crafting your own pad sounds and more advanced topics.

If you get stuck at any point, you can reach out to our support team at support@1010music.com. You can also reach out to the community of razzmatazz users at forum.1010music.com.

GET SET UP

SET UP THE HARDWARE



1. Insert the microSD (1) card into the microSD card slot (2) if it's not already inserted. The card must be in the slot for the razzmatazz to boot up. The card is spring-loaded. Push to eject when needed, but leave it in for now.
2. Connect the stereo Line Out (3) to your mixer, speakers or headphones. Be sure to use a TRS cable to hear both channels.
3. Connect an optional MIDI controller to the MIDI IN (4) jack. TRS Type A and B are supported for MIDI In. Type B is supported for MIDI Out. Use the included adapter (5) to connect to controllers that use MIDI 5 Pin DIN.
4. Connect the USB power cable (6) to the USB port (7). The razzmatazz can be powered by a standard 5V, 500 mA USB power adapter or USB battery. The razzmatazz will start up as soon as it receives power. There is no power button.
5. Finger drum on the Pads Home screen, or play notes on the MIDI controller and you're making some beats!

GET THE LATEST FIRMWARE

This User Guide is based on Version 1.1 of the razzmatazz firmware. To see which version is on your product, push the Home button to go to the Pads Home screen, then push the Left Arrow button to go to the nanobox Config screen. The loaded firmware version is displayed at the top of the screen, just to the left of the clock.

Future updates will be available for download at <https://forum.1010music.com>, after you register for the forum. The [instructions for downloading and installing the firmware](#) are included near the end of this document, and are in the Downloads section of the forum.

FIRMWARE VERSION

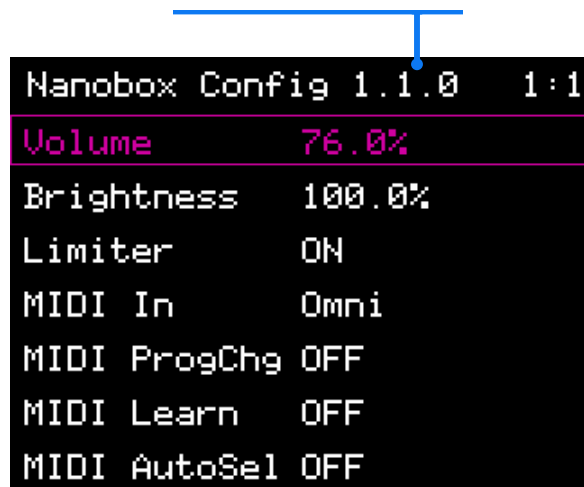

FIND YOUR WAY AROUND

Let's get familiar with the basic controls and the maps of available screens.

BASIC CONTROLS

When you first power up the razzmatazz, you will see the Pads Home screen. You can dive right in by tapping the pads and you will hear the drums play. Here is an overview of the hardware controls and the onscreen controls on the Pads Home screen.

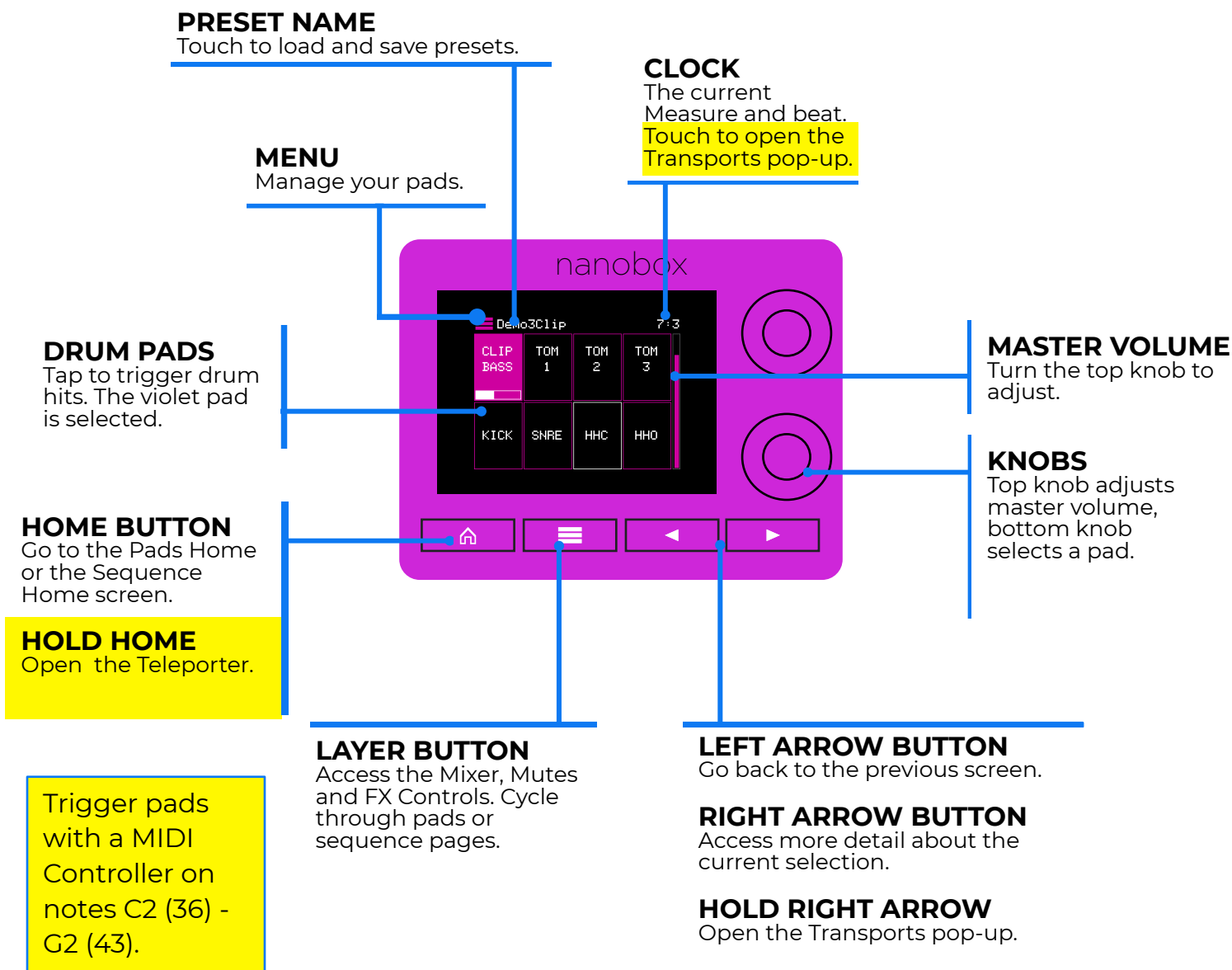

THE TELEPORTER

The Teleporter map will guide you around the razzmatazz's key functions. It is also a quick way to jump directly to any of the primary screens. Hold down the Home button from anywhere to open the Teleporter. Then touch a box to jump to that screen. Once you've used the Teleporter as a shortcut, you can navigate elsewhere by the usual navigation paths, but remember that you can't get back to the Teleporter using the Left Arrow button.



PADS SCREENS

Finger drum, tweak a pad's sound, and configure a pad's soundscape on the Pads screens. Push Layer from the Pads Home screen to access the Mixer and the FX screens.

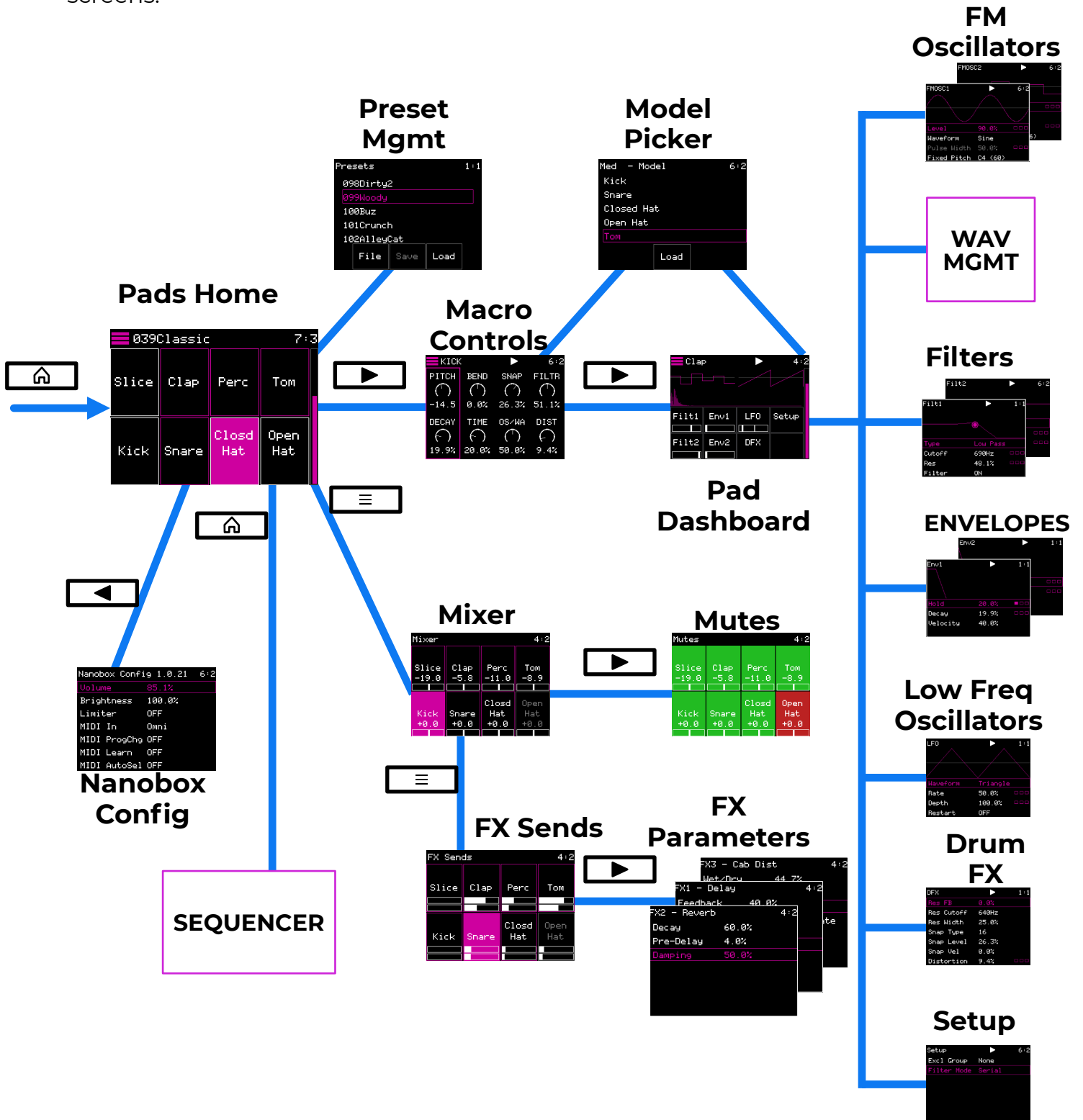

WAV MANAGEMENT SCREENS

From here, you can add a sample from the microSD card as a pad sound source, and record new samples.

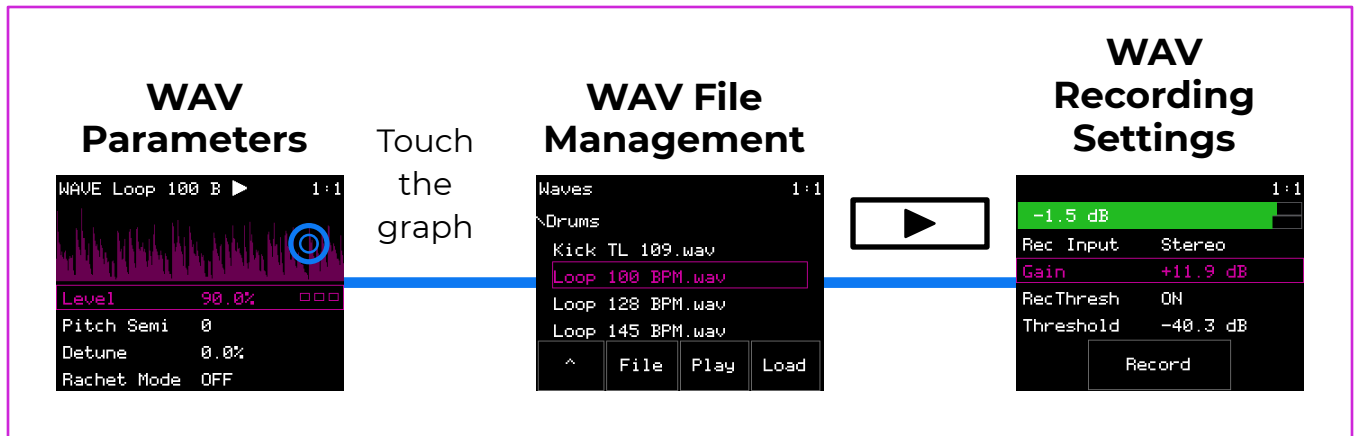

SEQUENCER SCREENS

Play sequences, edit them via the touchscreen, and control their playback options on the sequencer screens. Touch the clock in the top right corner or hold down the Right Arrow from anywhere to launch the Transports screen, where you can control playback of sequences and clip pads.

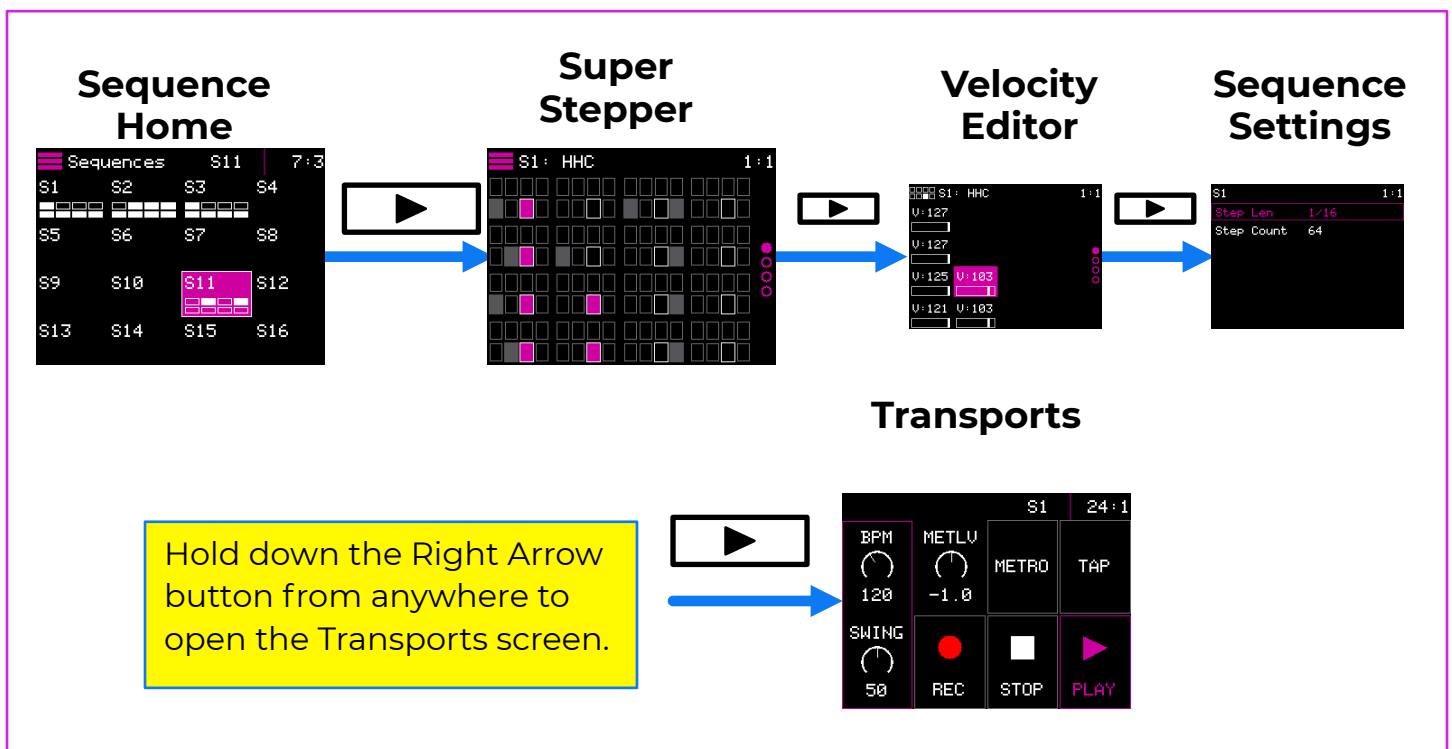

KIT PRESETS

The sounds and sequences in the razzmatazz are organized into two kinds of presets: Kit Presets and Pad Presets. In this section, we will talk about Kit Presets. We will cover [Pad Presets](#) and the Pad Bank later.

Kit Presets hold all of the Pad, Mixer, FX and Sequence settings together in one place. There are 120 factory Kit Presets loaded on the microSD card. You can customize these and save your changes in place of the original preset or as a new preset. You can also create your own presets. You are limited only by the space available on the microSD card.

Changes to kit presets are only saved when you select the Save option. They are not automatically saved. When you switch presets or power down the nanobox, any unsaved changes will be lost.

Each preset holds:

- Pad settings, including pointers to WAV files on the microSD card
- Mixer settings
- FX sends
- FX parameters
- Sequences and their settings
- Default sequence selection
- MIDI mappings and modulation settings

**Changes to kit
presets are
not
automatically
saved.**

MANAGE PRESETS

Presets are not saved until you choose to save them. This means you can quickly revert to a preset's saved settings by reloading it. You can choose to Save the current settings into the same preset, or to Save As a new preset.

You can create your own presets, rename them and delete the ones you no longer want.



Pads Home

Load a Preset

1. Push the Home button until you see the Pads Home screen. Touch the name of the preset in the header, **039Classic** in the screenshot to the right. This will open the Preset Management Screen.
2. Turn a knob to highlight the preset you want to load.
3. Touch the Load button.

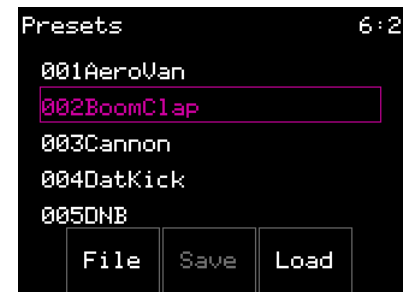

Preset Management

The Pads Home screen is displayed with the new drum kit and sequences loaded. If the transports are running, the default sequence selected in the loaded preset will start to play.

Save a Preset

1. Push the Home button until you see the Pads Home screen. Touch the name of the preset in the header to open the Preset Management Screen.
2. Touch Save. The current settings are saved to the currently selected preset, overwriting any previously saved settings.

Save As a New Preset

1. Push the Home button until you see the Pads Home screen. Touch the name of the preset in the header to open the Preset Management Screen.
2. Touch File to open the File menu.
3. Touch Save As. This will open the file naming screen, as shown below.
4. Enter a name for the preset and touch Enter. You can touch letters in the on screen keyboard to type them. Turn the top knob to move the cursor position. Turn the bottom knob to scroll through characters arcade style. When you touch Enter, all changes are saved to a newly created preset, which is then loaded.



Preset Management

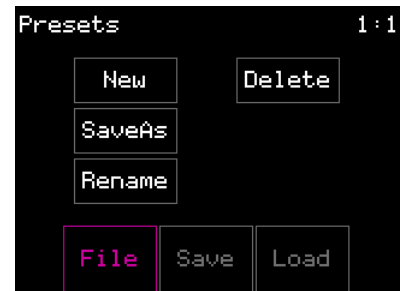

Preset File Menu

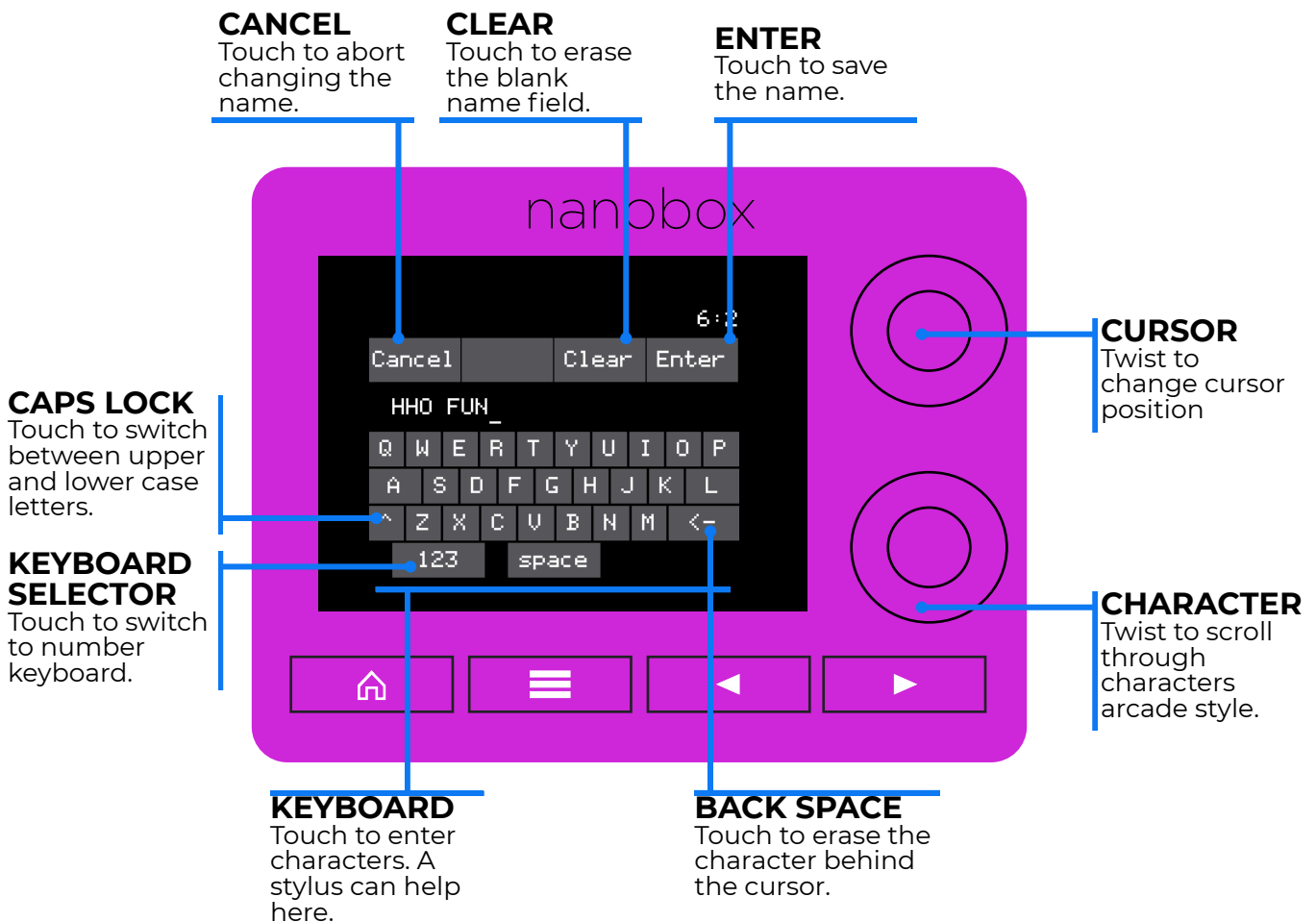

Create a New Preset

New presets start with default model assignments and settings for each pad.

1. Push the Home button until you see the Pads Home screen. Touch the name of the preset in the header to open the Preset Management Screen.
2. Touch File to open the File menu.
3. Touch New. This will open the file naming screen.
4. Type in a name for the preset and touch Enter. A new preset is created with the name you entered. The preset is then loaded.

Rename a Preset

1. Push the Home button until you see the Pads Home screen. Touch the name of the preset in the header to open the Preset Management Screen.
2. Scroll to select the file you want to rename.
3. Touch File to open the File menu.
4. Touch Rename. This will open the file naming screen with the default set to the current file name.
5. Select a new name for the preset and touch Enter. When you touch Enter, the preset is renamed with the name you entered. The Preset file list is then displayed.

Delete a Preset

1. Push the Home button until you see the Pads Home screen. Touch the name of the preset in the header to open the Preset Management Screen.
2. Scroll to select the file you want to delete.
3. Touch File to open the File menu.
4. Touch Delete. This will prompt you to confirm this action. Touch OK to confirm, or touch anywhere else to cancel. You can also push the Left Arrow button to cancel.
5. After you confirm the delete, the file will be removed from the microSD card. This cannot be undone.

PLAY THE PADS

FINGER DRUM

It's time to make some noise! The Pads Home screen has 8 pads which can be customized to build the drum kit you need for your song. Push the Home button if needed until you see the Pads Home screen. You can trigger playback of a pad simply by tapping it on the touchscreen. You can adjust the volume if needed by turning the top knob while on the Pads Home screen. The gauge along the right side of the screen shows the current level.

PLAY WITH A MIDI CONTROLLER

The razzmatazz is designed to be played with a MIDI Controller. Many of the presets are set up to support sound dynamics related to MIDI velocity, so you can get more variety in your playback. Connect your MIDI controller to the mini-TRS MIDI Input jack on the back of the razzmatazz directly or via the provided MIDI Adapter. The TRS jack can accept TRS Type A or Type B inputs.

If you are using a keyboard, the pads map to the MIDI notes as shown here:



Pads Home Screen

E2 MIDI 40	F2 MIDI 41	F#2 MIDI 42	G2 MIDI 43
C2 MIDI 36	C#2 MIDI 37	D2 MIDI 38	D#2 MIDI 39

Pads MIDI Mapping

A white frame appears around pads when they are triggered by MIDI or a Sequence.

If you are working with a pad controller, try hitting the pads to see which range maps to the pads on screen. The pads will flash white when triggered. We have chosen a note range that should map to a convenient set of pads for most common pad controllers.

By default, the razzmatazz is set up to respond to all MIDI channels. You can select a specific channel if needed on the Nanobox Config screen. From the Pads Home screen, touch the left arrow to access the Nanobox Config screen, and then select a channel for the MIDI In parameter. Turn the top knob to select a row in a parameter list, and then turn the bottom knob to select a value.

TWEAK THE SOUND WITH MACRO CONTROLS

On the Pads Home Screen, the currently selected pad has a violet background. Push the Right Arrow button to navigate to the Pads Macro Controls for the selected pad. The Macro Controls provide quick access to pad settings for use during live performance. The set of available controls depend on the drum model used for the selected pad. Turn the knobs to adjust the controls in the focus ring. You can also touch and drag a knob on the screen to adjust its value. Tap a column to move the knob focus.

Touch the Layer button to change to the next pad. The Pad Name in the title updates to match the current pad. Touch the Pad Trigger in the header, or play the corresponding MIDI note, to trigger the pad and hear your changes in real time.

Each pad is assigned a drum model. We will get into more detail about drum models later. For now, it's enough to know that the set of knobs available on the Macro Controls screen varies based on the model of the currently selected pad.

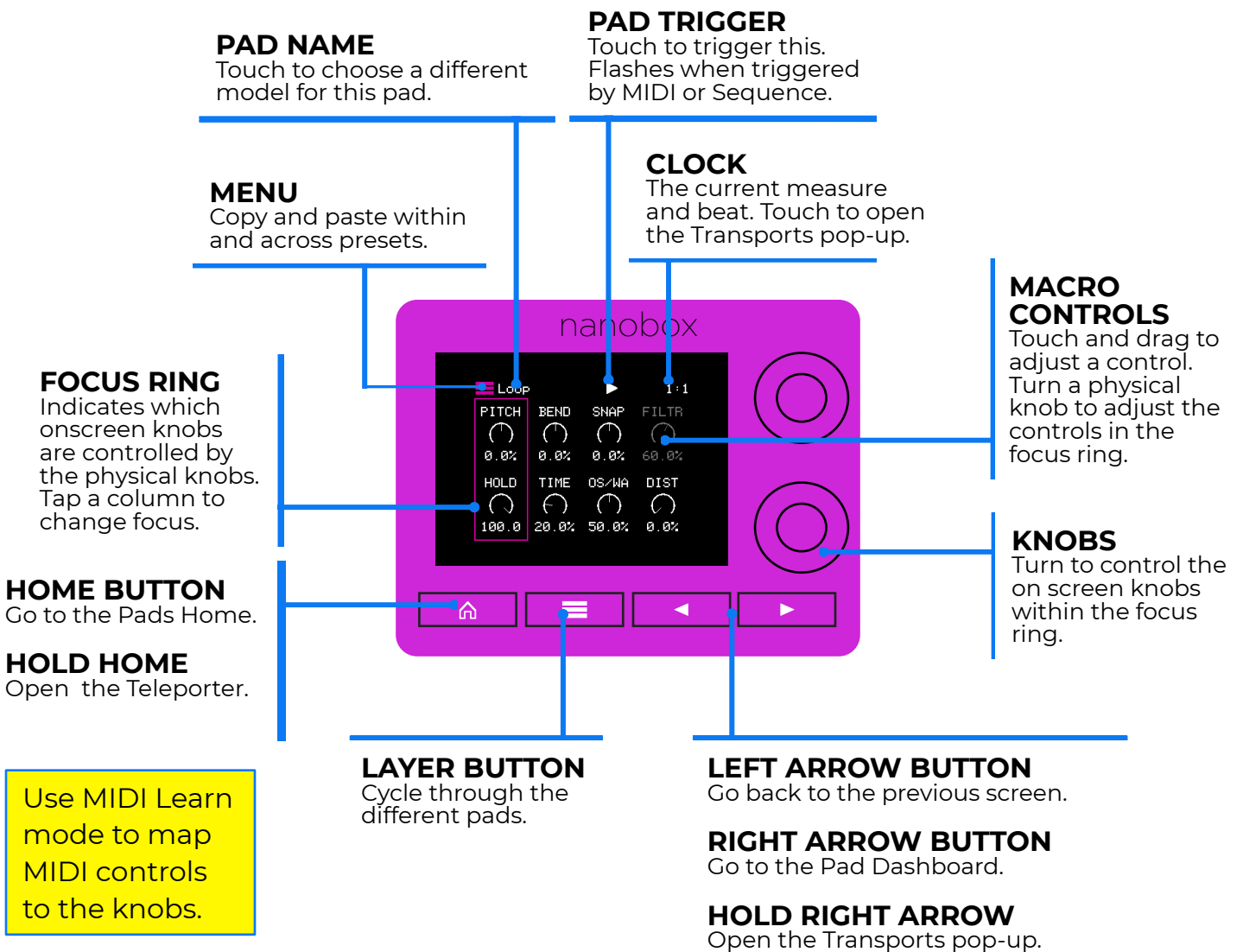

Common Macro Controls

Here are the settings you will find on the Macro Controls screen.

Knob	Description
PITCH	<p>Adjust the pitch in a range of +/- 2 octaves. This is not quantized to semitones. See the FM Oscillators' Fixed Pitch parameter and the WAV's Pitch Semi parameter to adjust the sound by semitones. The Detune parameter of the FM Oscillators and the WAV can be used to move the sound away from the exact semitone value. See the discussion about Pad Pitch below for more information.</p> <p>The Pitch knob will be disabled when there are no sound sources that can be tuned via pitch. FM Oscillators with a waveform of Noise cannot be pitch adjusted.</p>
DECAY	Dial down the Envelope 1 decay to get quick drum hits. Dial it up to elongate the sound.
BEND	The Bend controls how much the pitch changes over the duration controlled by the Time knob. Negative values adjust the pitch lower. Positive values adjust the pitch higher.
TIME	Controls the span of time over which the pitch bend occurs.
SNAP	Controls the snap level, or loudness of the initial click sound. This only works if the DFX Snap Type is set to something other than None on the Drum FX screen.
OS/WA	Adjust the relative balance of the FM Oscillators and the WAV sound source. Turn left to hear more of the FM Oscillators. Turn right for more of the WAV.
FILTR for Clips and Slicers	Apply a high pass (to the left) or low pass (to the right) filter to a Clip or Slicer pad.
FILTR for all other models	The Filt 1 cutoff. This knob will be disabled if Filter 1 is OFF. See the section on Filters below to learn how to enable the filter.
DIST	Add DFX distortion to get a grittier sound.
HOLD	Adjust the Envelope 1 Hold to control how long the sound will be held.
RES	The Filter 1 Resonance amount to control the shape of the frequency response near the cutoff frequency. The RES knob will be disabled when Filter 1 is OFF.

Macro Controls for Clip and Slicer Pads

The following Macro controls are specific to Clip or Slicer Pads.

Knob	Description
QUANT	<p>Playback of a Clip pad will start and end on the next quantization boundary selected here. For example, if the Quant is set to 1 bar, the playback will begin at the start of the next bar.</p> <p>Applies to Clips only.</p>
SYNC	<p>Sync is only enabled when the Quant Size is not None. The Sync feature prevents timing drift that can occur when the length and BPM of a clip does not align exactly with the tempo of playback. When Sync is used, nanobox razzmatazz will realign the audio to match the clock at the step size specified here.</p> <p>Select a value for Sync that will control the size of the musical unit to which the clip will be synchronized. Choose small settings, like 1/16th, for rhythmic or percussion clips. Choose large settings, like 1-bar, for sustained tones or drones.</p> <p>Applies to Clips only.</p>
SLICE	<p>Specify which slice will be played. Use SLSEQ knob to add some variety.</p> <p>Applies to Slicers only.</p>
SLSEQ	<p>When Slice Sequencer is set to a value other than None, each new note will advance the selection of the next slice to play.</p> <p>None: Always play the same slice.</p> <p>Forward: Play the next slice each time the pad is triggered.</p> <p>Backwards: Play the previous slice each time the pad is triggered.</p> <p>Random: Randomly select a slice to play</p> <p>Stagger: Slice selection will change in a somewhat random way. It will move forward a few slices, then back a couple of slices, and repeat.</p> <p>Applies to Slicers only.</p>

Macro Controls For Each Model

The razzmatazz is designed to give you the controls you need when you need them. On the Macro screen, the set of knobs available varies based on the model assigned to the pad. The table below shows which controls are available for each model. This is one of the reasons why it's important to choose the correct model for each pad.

Knob	Kick	Snare	Tom	Sample	Closed Hat	Open Hat	Clip	Slicer
PITCH	Y	Y	Y	Y	Y	Y	Y	Y
DECAY	Y	Y	Y		Y	Y	Y	Y
BEND	Y	Y	Y	Y				
TIME	Y	Y	Y	Y				
SNAP	Y	Y	Y	Y	Y	Y		
OS/WA	Y	Y	Y	Y	Y	Y		
FILTR	Y	Y	Y	Y	Y	Y	Y	Y
DIST	Y	Y	Y	Y				
HOLD				Y				Y
RES					Y	Y	Y	Y
QUANT							Y	
SYNC							Y	
SLICE								Y
SLSEQ								Y

SEQUENCES AND TRANSPORTS

Finger drumming can be fun, but the razzmatazz also has a built-in step sequencer so you can record and playback sequences.

START AND STOP A SEQUENCE

1. Push the Home button once or twice until you see the Sequence Home Screen.
2. Touch one of the 16 sequences in the grid to select it.
3. Touch the clock in the upper right corner of the screen to open the Transports popup, then touch Play to hear the selected sequence.
4. Push the Left Arrow button to go back to the Sequence Home screen.
5. Tap a different sequence in the grid, and that sequence will start when the current sequence finishes.
6. Push the Right Arrow button to go to the Super Stepper screen and watch the cursor advance through the steps. The Super Stepper is a type of Step editor that allows you to see the steps for all of the pads at once, while also allowing you to focus on one pad at a time.
7. Touch the clock again to open the Transports popup, and then touch Stop to end playback.

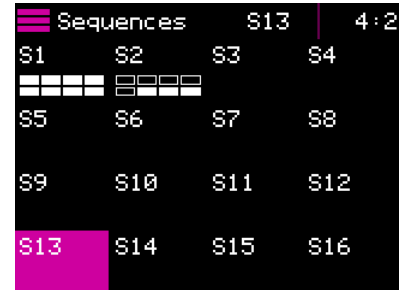

Sequence Home

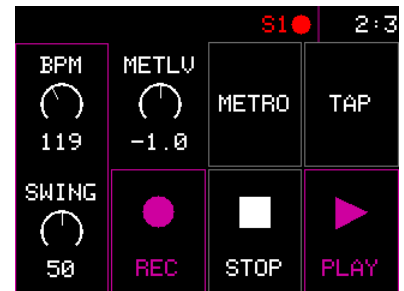

Transports Pop-Up

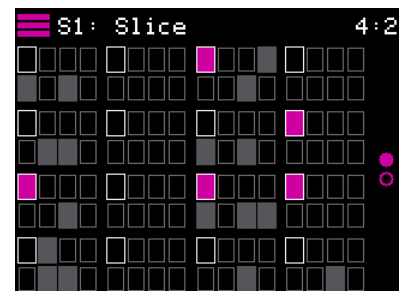

Super Stepper

Sequence thumbnails show you which pads are used in the sequence.

THE TRANSPORTS POP-UP

There are two ways to quickly access the Transports pop-up from anywhere in razzmatazz:

1. Touch the Clock in the top right corner of the screen.
2. Hold down the Right Arrow button.

From here, you can start and stop playback and recording of sequences, start playback of clip pads (more on those later), and set up the metronome. You can also set the tempo and adjust the swing.

The name of the currently selected sequence always appears to the left of the clock at the top of the screen.

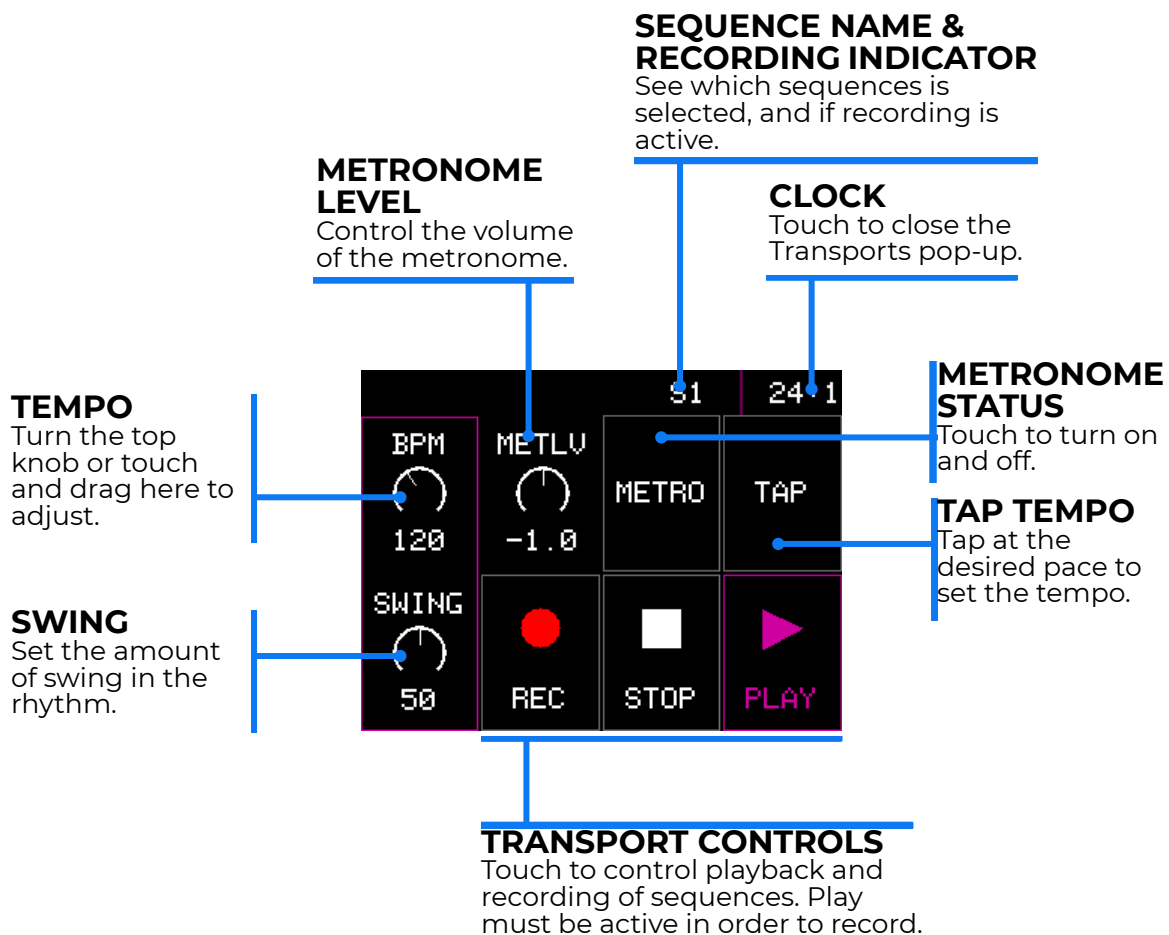

Sequences play in a loop until you change sequences or push STOP.

Set the Tempo

There are two ways to set the tempo: the BPM knob and Tap tempo.

1. Open the Transports pop-up by touching the clock or holding the Right Arrow button down.
2. Touch the TAP button repeatedly in the desired tempo. The razzmatazz will detect the tempo and set the value for the BPM after a few taps.
3. Touch the BPM knob to make sure the focus ring is around it. Turn the top knob to adjust the tempo to a specific number.

The sequence playback speed will adjust in real time if you change the tempo while a sequence is playing.

Adjust the Swing

The Swing setting makes electronic music sound more like a live performance by controlling the relative timing of even numbered 1/16 notes compared to the notes on either side of them. When set to the default of 50%, the even 1/16 notes occur in their metered place halfway between the notes on either side. When less than 50%, the even 1/16 notes shift closer in time to the previous note. When greater than 50%, the even 1/16 notes shift closer in time to the following note.

1. Open the Transports pop-up by touching the clock or holding down the Right Arrow button.
2. Touch the Swing knob to make sure the focus ring is around it. Turn the bottom knob to adjust the swing.

The Step Length for the Sequence must be 1/16 or smaller to hear the effects of the Swing setting.

If you have a sequence playing, you can hear the swing changes in real time.

Enable the Metronome

You can turn the metronome on and off and adjust how loud it is on the Transports pop-up.

1. Open the Transports pop-up by touching the clock or holding down the Right Arrow button.
2. Touch the METRO button to toggle the state of the metronome. The button has a violet colored frame and text when active.
3. Touch the METLV knob to make sure the focus ring is around it. Turn the top knob to adjust the volume of the metronome.

Record a Sequence

You can record a sequence that is played directly on the pads or over the MIDI inputs.

1. Push the Home screen once or twice to go to the Sequence Home screen.
2. Touch an empty sequence to select it. This is the sequence that you will record into.
3. Open the Transports pop-up by touching the clock or holding down the Right Arrow button.
4. Hold the PLAY button while you tap the REC button. The Sequence name in the title will turn red and a red circle appears to indicate you are recording.
5. Push the Home button twice to go to the Pads Home screen.
6. Tap in a rhythm. The sequence will play in a loop when it reaches the end of the sequence length, which is 1 measure by default. You can add additional drum hits by playing along with the loop.
7. You can also trigger pads using an external MIDI controller and they will be recorded.
8. When done, open the Transports pop-up and tap REC to stop recording while continuing to play the sequence, or tap STOP to end recording and playback.

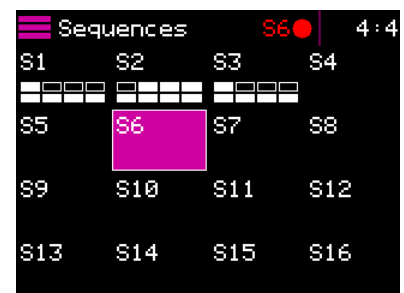

Sequence Home

Tip: Change the configuration for a pad to hear your sequence with new sounds.

EDIT SEQUENCES WITH THE SUPER STEPPER

The nanobox | razzmatazz can store 16 sequences for each preset. You create sequences by recording them in real time using the Pads Home screen or a MIDI controller, or by entering them into the Super Stepper. We covered recording sequences when talking about the Transports pop-up above. Here we will cover setting up sequence options and see how to use the Super Stepper to quickly and easily lay down a pattern using the touch screen.

BASIC WORKFLOW FOR SEQUENCE CREATION

1. Select an open Sequence Slot on the Sequence Home Page.
2. Set the step length and number of steps on the Sequence Configuration screen.
3. Record via finger drumming from Pads Home screen or using MIDI input.
4. Edit a sequence on the Super Stepper screen.
5. Edit Velocity for pad trigger events.
6. Repeat steps 3-5 as needed.

CREATE & EDIT SEQUENCES

Set Sequence Step Length and Step Count

Each sequence can be configured to have a different Step Length and Step Count. The resulting length of the sequence will be step length x step count.

1. Push Home once or twice to get to the Sequence Home page.
2. Touch a sequence to select it.
3. Navigate to the Sequence Setup screen:
 - a. Hold down the Home button to open the Teleporter screen, and then touch the Seq Setup button in the lower right corner.
 - b. Alternatively, you can push the Right Arrow button 3 times from the Sequence Home screen.
4. On the Sequence Setup screen, turn the top knob to choose a setting to edit. Turn the bottom knob to select a value.



Teleporter

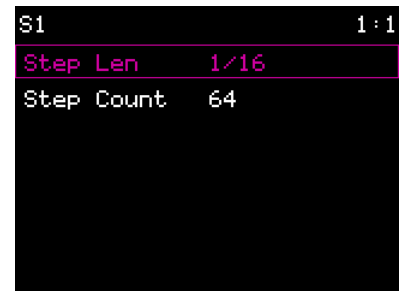

Sequence Setup

Setting	Description
Step Len	The length of time between note event triggers for this sequence. Range: 1/64, 1/32T, 1/32, 1/16T, 1/16, 1/8T, 1/8, 1/4T, 1/4, 1/2T, 1/2, 1 bar, 2 bars, 4 bars, 8 bars (T = Triplet)
Step Count	The number of steps, or note event triggers, in the sequence. Push Layer button to access additional pages of steps on the Super Stepper and Velocity Editor screens. Range: 1 to 64

Create and Edit a Sequence with the Super Stepper

The razzmatazz Super Stepper takes advantage of the touch screen to allow you to edit a pattern for one pad, while you can still see the pattern for the other pads.

Each small box on the Super Stepper screen represents one pad in one step of the sequence. Each group of 8 pads in the 4 x 4 grid is a step in the sequence.

Tap or swipe across steps to add or remove triggers for the selected pad.

Pad triggers for the selected pad are shown in violet. Pad triggers for the other pads are shown in gray. Turn the top knob to change the selected pad. The white pad outline moves and the pad name in the header updates as you turn the knob. The violet boxes show the steps where the currently selected pad will trigger.

Push the Layer button to cycle through the pages for longer sequences.

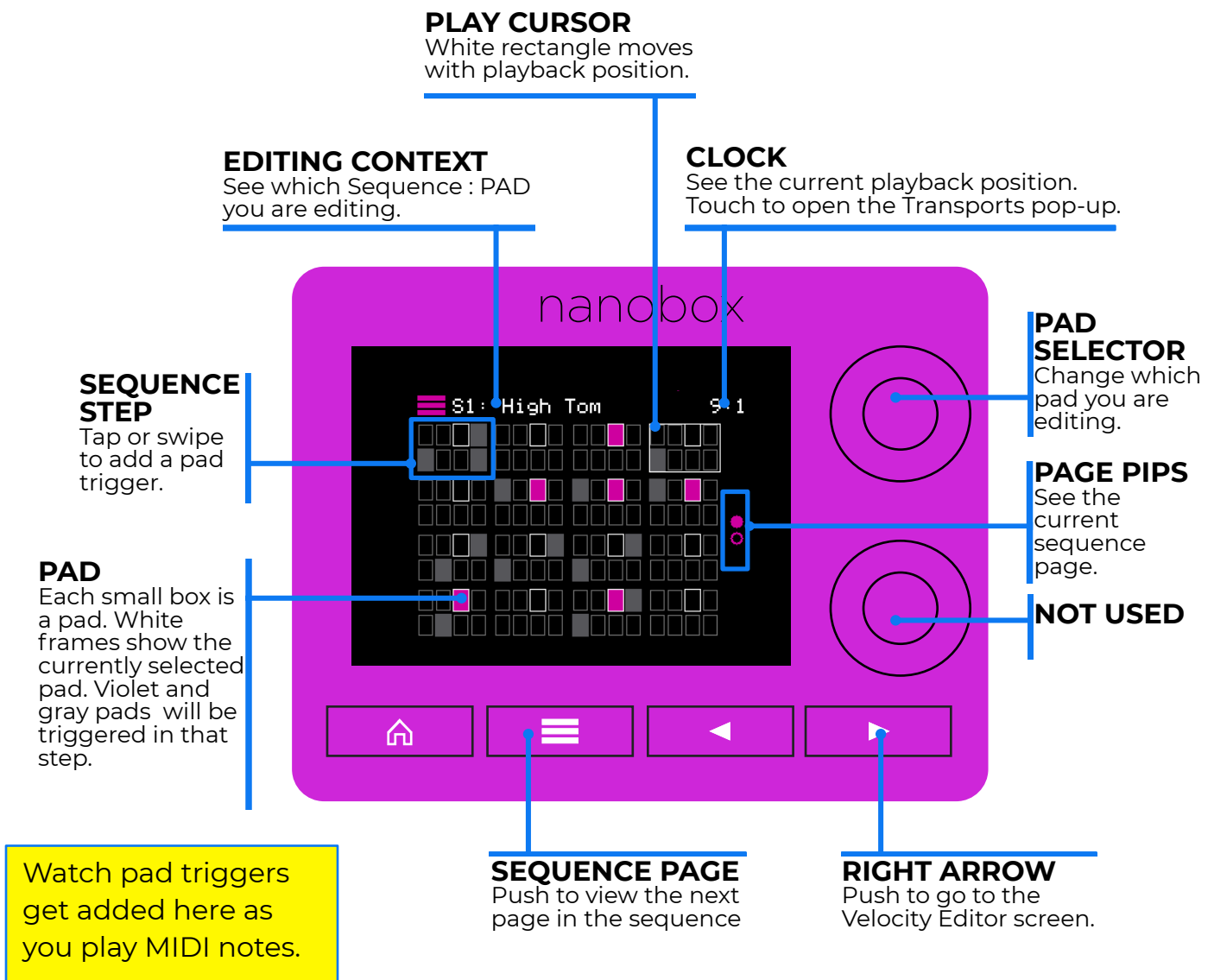

Edit Velocity of Pad Trigger Events

Push the Right Arrow button while on the Super Stepper to go to the Velocity editor. This page displays the velocity for the selected pad in the steps that have event triggers for this pad. Touch a step to select it, and then turn the bottom knob to adjust the velocity. Turn the top knob to cycle through the individual pads. Push the Layer button to advance through the sequence pages for longer sequences.

If you record a sequence into the razzmatazz using a MIDI controller with velocity sensitive controls, the razzmatazz will record the velocity along with the event timing. When you record in a sequence, the beats are quantized to the nearest step.

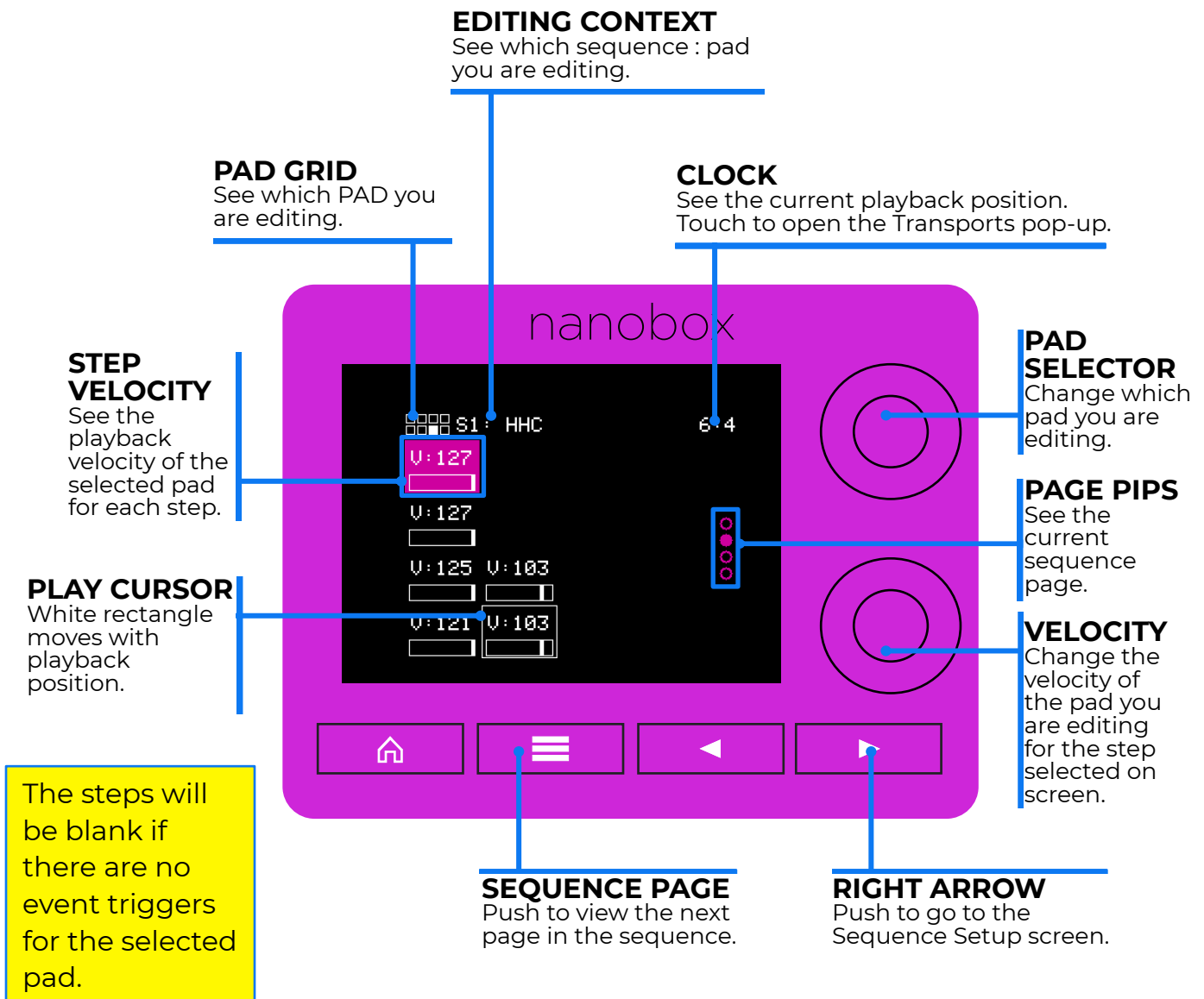

Copy, Paste, Clear and Extend Sequences

You can get a head start on your next sequence by copying and pasting a sequence in the same preset or another preset. (Remember to save changes before switching presets.) You can also quickly extend a sequence pattern with the Double function. If you want to start fresh, you can clear a sequence.

1. Push Home once or twice to open the Sequence Home screen.
2. Select the sequence you want to use by touching it.
3. Touch the hamburger menu in the top left corner of the screen.
4. Select the option you want from the menu, or push the Left Arrow to cancel.

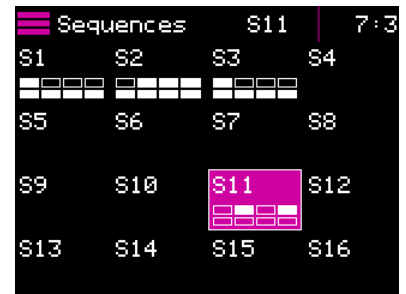

Sequence Home

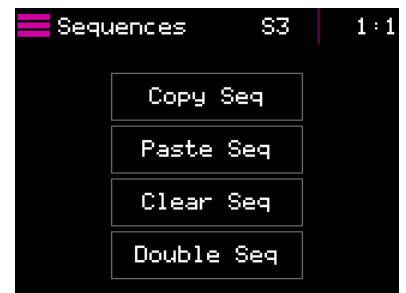

Sequence Menu

Menu Option	Description
Copy Seq	Copies the selected sequence into the clipboard. This includes all event triggers for all pads, the Sequence Setup options, and the Velocity settings.
Paste Seq	If there is a sequence on the clipboard, this will paste that sequence into the currently selected sequence.
Clear Seq	Clears the event triggers and velocity settings for the selected sequence. The Sequence Setup options (Step Length and Step Count) will stay the same.
Double Seq	Extends the current sequence by copying all of the steps and pasting the copy to the end of the current sequence.

MIXING AND MUTING

On the razzmatazz Mixer and Mutes screens you can control level, pan and mute state of all pads. This allows you to balance the overall mix of the instruments.

NAVIGATE TO THE MIXER AND MUTE SCREENS

From the Pads Home screen, push the Layer button to access the Mixer screen. Push the Right Arrow button to toggle to the Mute screen. You can also hold down the Home button to bring up the Teleporter and touch the Mixer or Mutes button to jump right there.

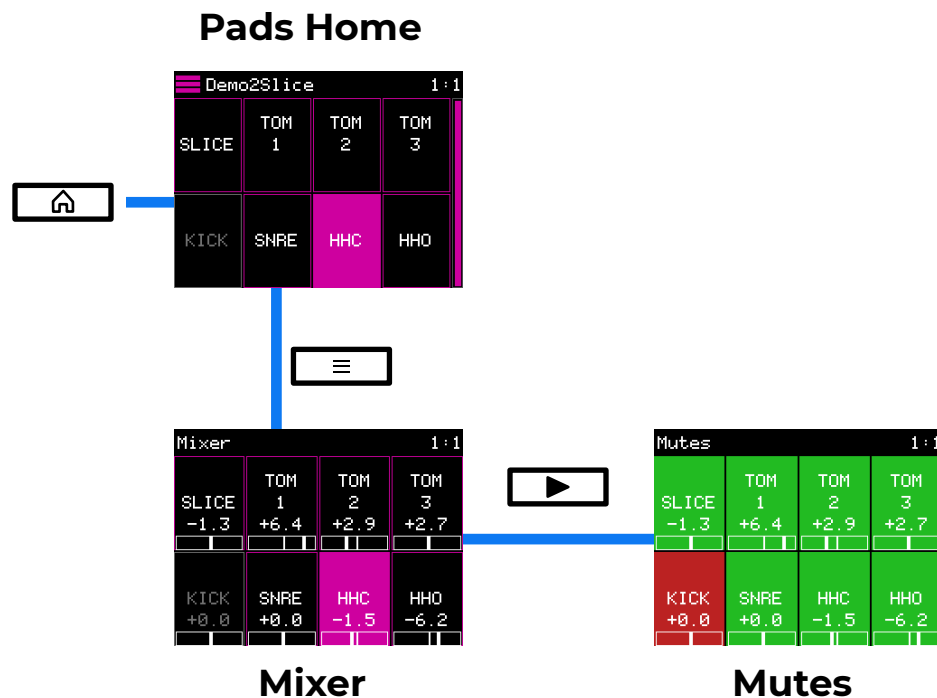

CONTROL THE MIX

On the Mixer screen, simply select a pad and then turn a knob to control its settings.

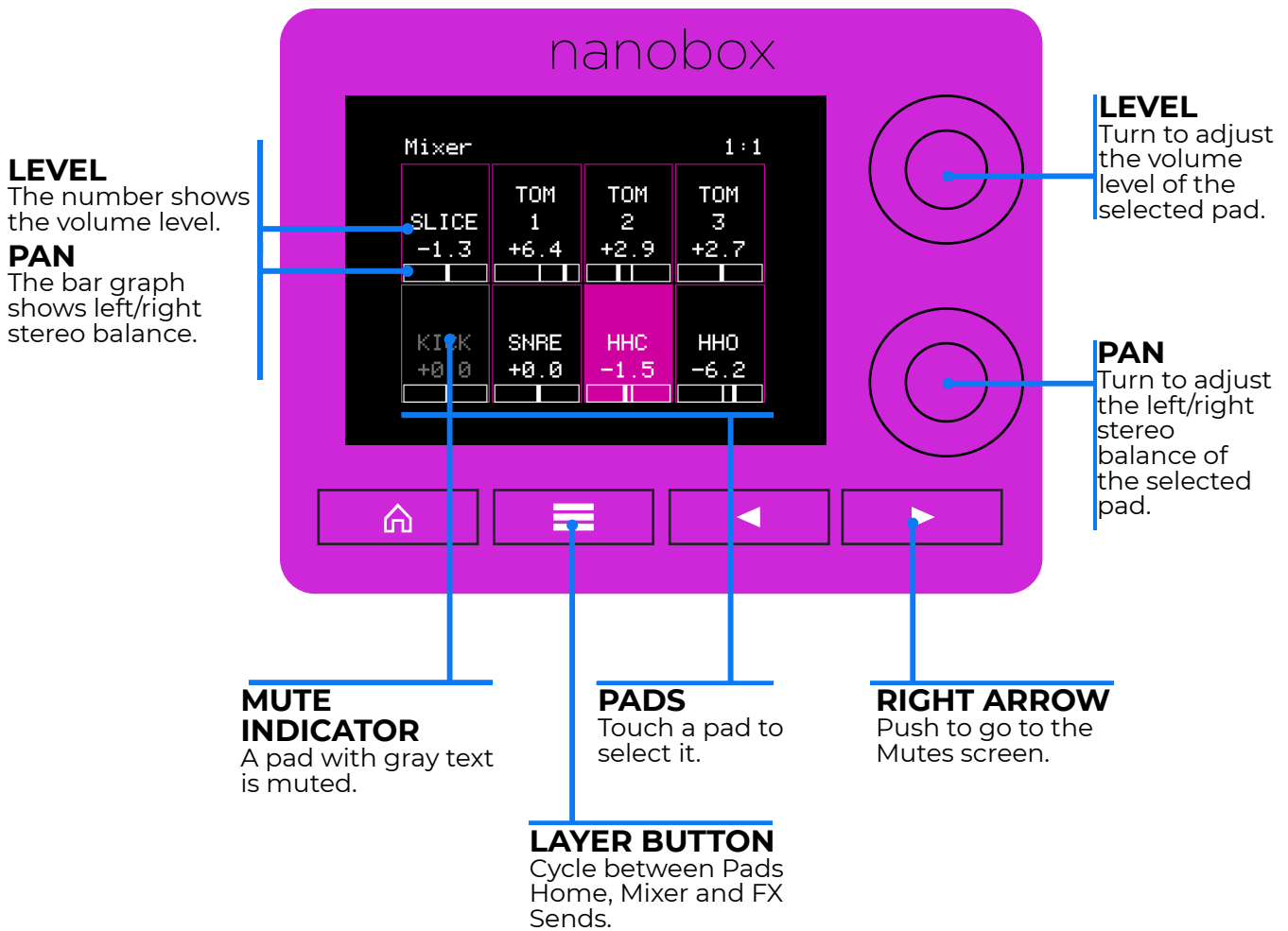

MUTE A PAD

On the Mutes screen, touch a pad to toggle the mute state of the pad. Red is muted, green is not muted.

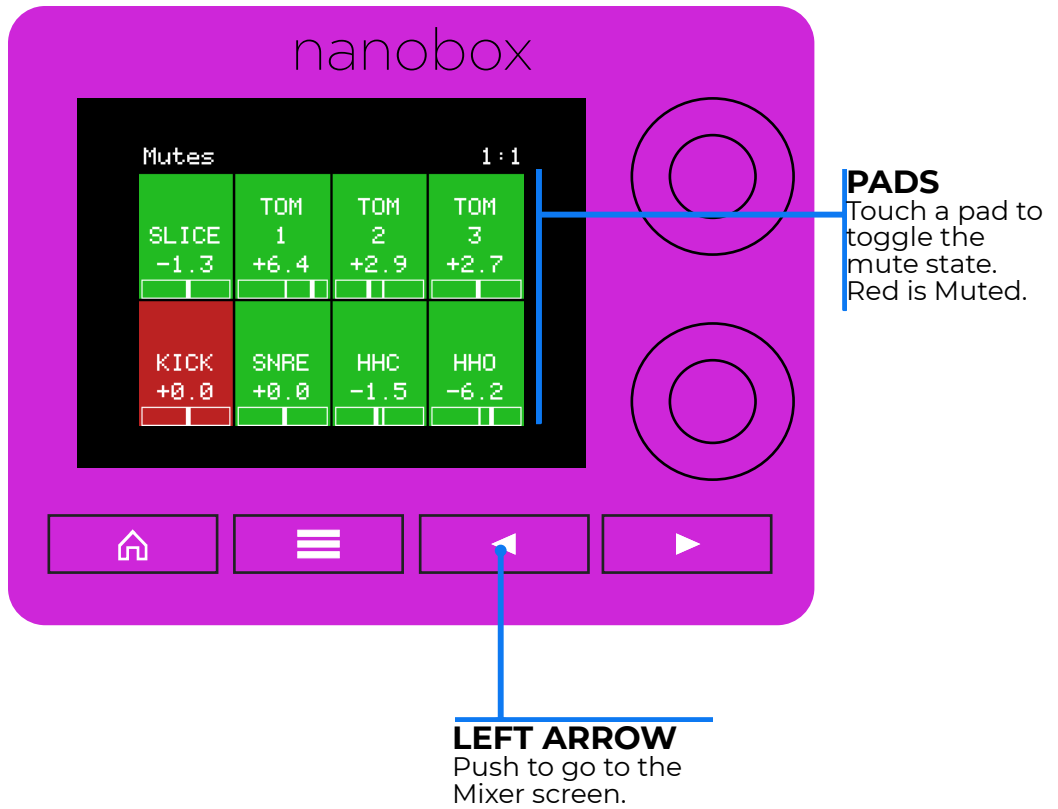

BUSSED AND GLOBAL EFFECTS

The razzmatazz has a few different layers of effects:

1. **Pad specific effects** - These are controlled from the [Pad Dashboard](#). We will cover this later.
2. **Bussed effects** - You can [configure pad-specific effects sends](#) for a delay and a reverb effect, and [adjust the delay and reverb settings](#).
3. **Global effects** - You can [adjust settings for a global cabinet distortion](#) that is applied to all pads.
4. **A Global Compressor** - You can turn this on and off on the [Nanobox Config](#) screen, covered later in this document.

In this section, we will cover the bussed effects and global effects. We will get into the pad-specific effects when we talk about the DFX on the Pad Dashboard. We will cover the Global Compressor when we get to the Nanobox Configuration screen.

NAVIGATE TO THE FX SCREENS

From the Pads Home screen, push the Layer button two times to get to the FX Sends screen. On the FX Sends screen, you can choose how much of each pad is sent to each of the two bussed effects: delay and reverb. From here, push the right arrow button to cycle through the parameter screens for the Delay (FX1), the Reverb (FX2), and the Cabinet Distortion (FX3).

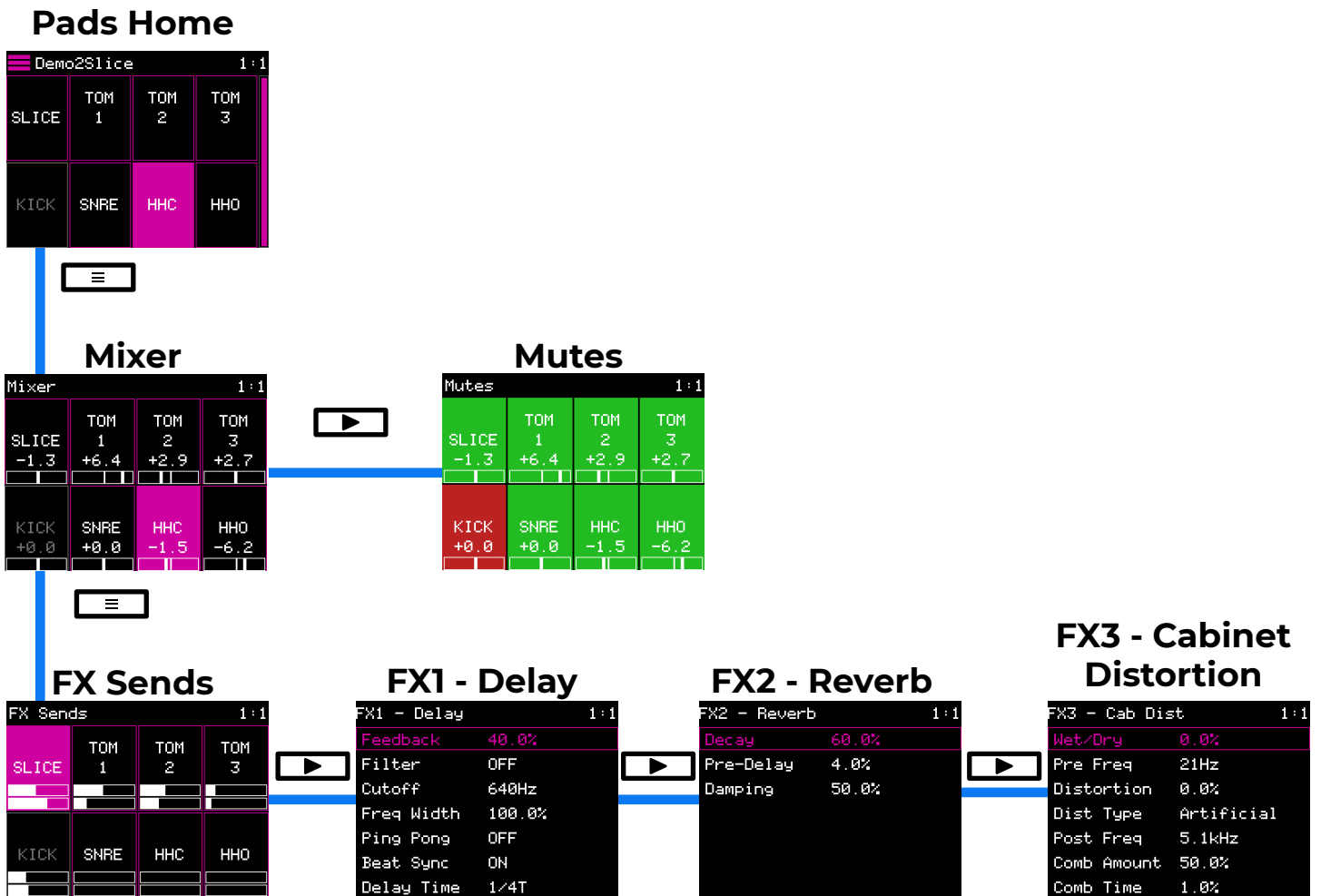

CONFIGURE EFFECT BUSSES WITH THE FX SENDS SCREEN

On the FX Sends screen, you choose how much of the audio signal for each pad is sent to FX1 - Delay, and FX2 - Reverb. Select a pad from the grid and turn the knobs to adjust the sends for FX1, shown on the top graph, and FX2, shown on the bottom graph.

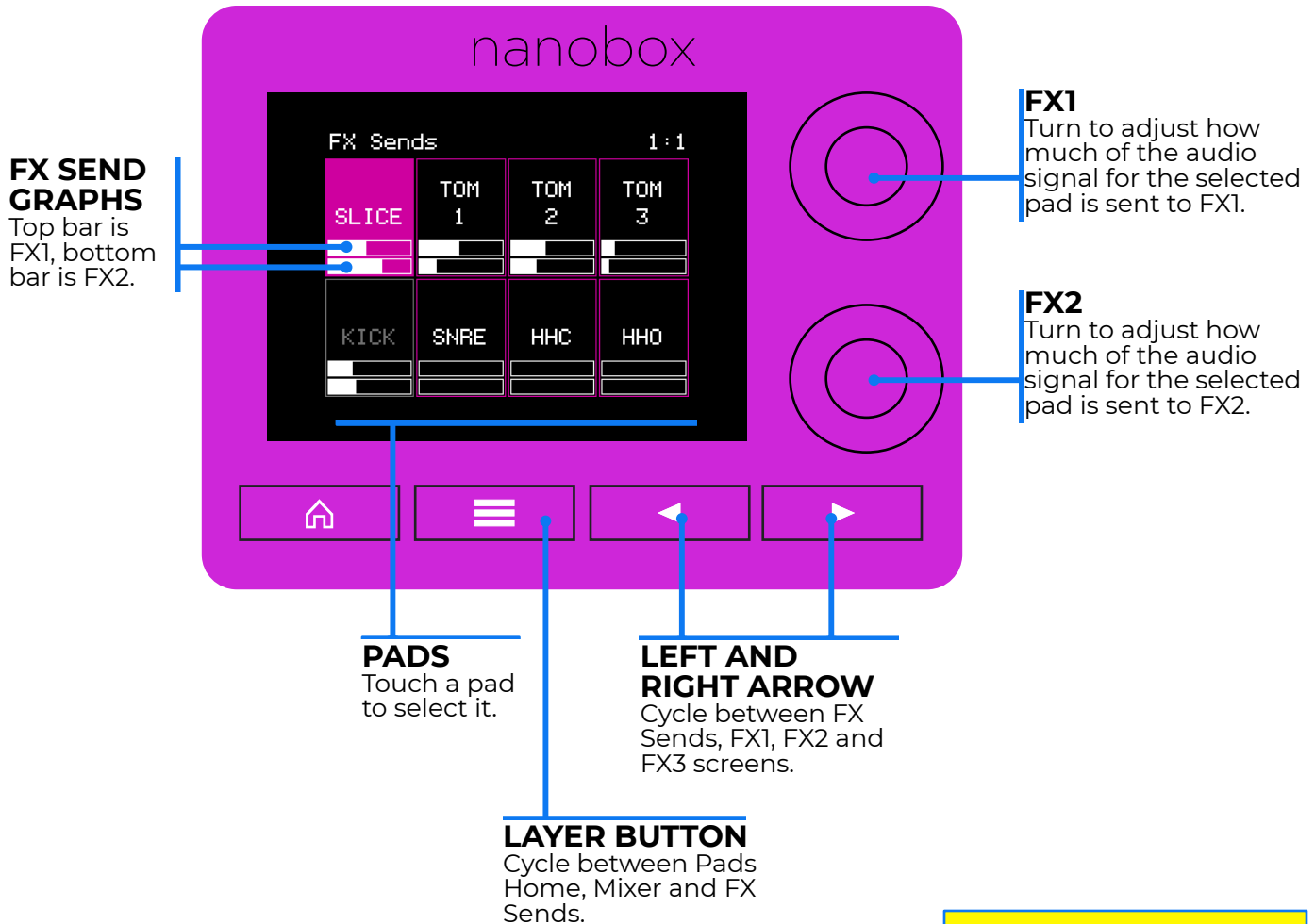

You can configure the FX Sends for the Line Input on the Nanobox Configuration Screen.

CONFIGURE EFFECT SENDS FOR THE LINE INPUT

When you connect an audio signal to the Line Input, that signal is also routed through the effects engine. You can configure the line input settings on the [Nanobox Configuration](#) screen, described below. Here, you can adjust the gain and the FX Sends. You can also choose to use a mono or stereo signal for the Line In here.

The Input Gain controls the level of the signal used overall. The main voice is then added to the signal sent to FX3. The Input FX1 and Input FX2 parameters control the sends of the Line Input signal to the respective FX engines.

FX VOICE ARCHITECTURE

After the processing is completed for each individual pad and the line input, the FX sends for each are sent to FX1 and FX2. The Voice Output is then combined with the output of FX1, and the result is sent to FX3, the cabinet distortion. The output of FX3 is then combined with the output of FX2 and sent to the Limiter, controlled on the Nanobox Configuration screen. The result is then sent to the line output.

The diagram below shows the signal flow for the effects. We will cover the voice architecture for the pads later when we talk about Sound Design with the Pad Dashboard. You can control the FX sends for the Line Input on the Nanobox Configuration screen.

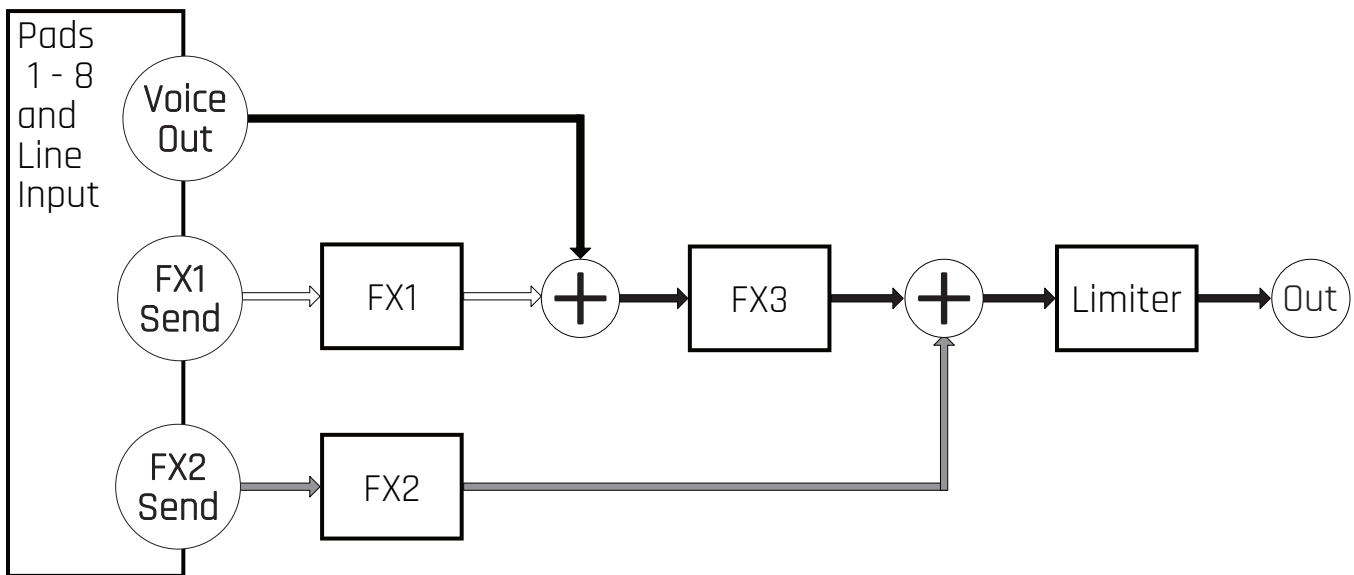

ADJUST FX SETTINGS

On the three FX screens you can configure the settings for the effects. On these screens, turn the top knob to choose a setting, and then turn the bottom knob to select a value. The tables below define the settings.

FX1 - Delay Settings

The delay can fatten the sound of the drums or add extra bounces or hits of the drum to each hit. At lower delay times, it may sound like a stronger hit. At higher delay times, it can sound like you are adding in extra drum hits. Add in the delay filter and you can add a different sound to the delayed drum hits.

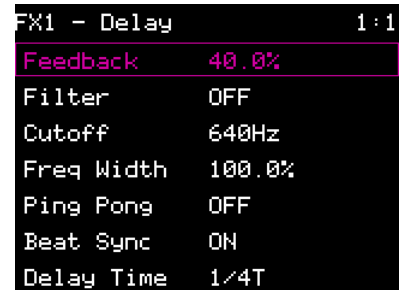

FX1 - Delay

Setting	Description
Feedback	The amount of regeneration or echo in the delayed signal. Set to 0% to get a single echo. Range: 0.0 to 100.0%
Filter	Turn Filter On and then adjust the cutoff and width parameters to filter the delay. This can add some variety to the sound by making the delayed hits sound different from the original hits.
Cutoff	When Filter is On, this is the center frequency for the band pass filter. Range: 20 Hz to 20.4 kHz
Freq Width	When Filter is On, the width of the range of frequencies included. Range: 0.0 to 100.0%
Ping Pong	When Ping Pong is on, the echoes will alternate (or ping pong) from side to side. When off, the echoes are the same in the left and right channels.
Beat Sync	When On, the delay is measured in musical time intervals. When Off it is controlled as a percentage. Use Beat Sync to keep the delayed sounds in time with your clock.
Delay Time	Determines the delay length. When Beat Sync is On, delay is specified in musical intervals: Range: 1/64, 1/32, 1/16, 1/8T, 1/16D, 1/8, 1/4T, 1/8D, 1/4, 1/2T, 1/2, 1 bar (T=Triplet, D=Dotted) When Beat Sync is Off, delay is specified as a percentage, where 100% is 4 seconds: Range: 0% to 100%.

FX2 - Reverb Settings

Add some reverb to a drum to add some length to the sound. Use longer values of Decay to make the sound trail on longer after the initial hit. Increase the Damping to reduce the airiness or hissing at the end of the sound. Use the Pre-delay to add some time between the initial hit and when you hear the echo.

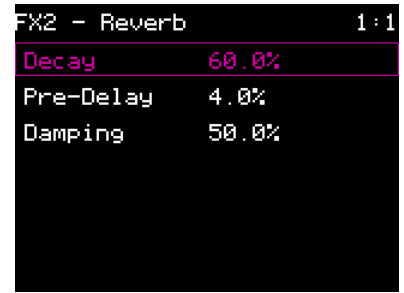

FX2 - Reverb

Setting	Description and Range
Decay	How much the reverberation will ring out. Range: 0 to 100%
Pre-Delay	The amount of time between the original dry sound, and the audible onset of early reflections. Range: 0 to 100%
Damping	How much damping is applied to the reverb. Higher values will make the reverb end sooner. Range: 0 to 100%

FX3 - Cabinet Distortion

The Cabinet Distortion also provides three different types of filters. You can add high pass and low pass filters, as well as configure a comb filter. You can choose from three different distortion algorithms based on the type of sound you want to achieve.

Make sure you dial up the Wet/Dry setting to apply FX3 to the signal.

The table below and continued on the next page describes the options available.

FX3 - Cab Dist		1:1
Wet/Dry	0.0%	
Pre Freq	21Hz	
Distortion	0.0%	
Dist Type	Artificial	
Post Freq	5.1kHz	
Comb Amount	50.0%	
Comb Time	1.0%	

FX3 - Cabinet Distortion

Setting	Description
Wet/Dry	Controls how much of the pre- and post- FX3 signals are used in the final output. Set to 100% to hear only the signal with the cabinet distortion applied. Set to 0% to hear only the signal with no cabinet distortion applied. Range: 0.0% to 100.0%
Pre Freq	The cutoff frequency of the high pass filter applied before the distortion. Range: 20 Hz to 20.4 kHz
Distortion	Controls how much overdrive the distortion will simulate. Set to higher numbers to get more clipping. Range: 0.0 % to 100.0%
Dist Type	The distortion model that will be used. Artificial is an artificial sounding digital distortion. Solid State is a more realistic sounding digital distortion that mimics a solid state amplifier. Tube mimics a tube amplifier distortion. Options: Artificial, Solid State, Tube
Post Freq	The cutoff frequency of the low pass filter applied after the distortion. Range: 20 Hz to 20.4 kHz

Setting	Description
Comb Amount	<p>How much of the output of the comb filter is included in the overall output.</p> <p>Range: -100.0 % to +100.0%</p>
Comb Time	<p>The comb filter plays the same sound twice, with a slight delay between the playback times. Set the delay time here.</p> <p>Range: 0.0 % to 100.0%, equivalent to 0.6 ms to 42 ms.</p>
Comb FB	<p>Further enhance the comb filtering effect by feeding back some of the output of the comb filter. Control the amount of feedback here. Negative values will feed back the inverted signal.</p> <p>Range: -100.0 % to 100.0%</p>
Comb LFO	<p>How much impact the low frequency oscillator has on the comb time.</p> <p>Range: 0.0 % to 100.0%</p>
Comb LFO Rt	<p>The rate of the low frequency oscillator that is used to vary the comb time.</p> <p>Range: 0.0 % to 100.0%, equivalent to 0.2 Hz to 10 Hz.</p>

CRAFT YOUR OWN SOUND

The razzmatazz comes with 120 presets to get you started. You can also customize these pads extensively or craft your own pads from scratch. When you have a sound you like, you can save a preset in order to save an entire kit, and you can save an individual pad to a file for re-use in other pads or presets.

Here's the general flow for designing the sound for a new pad:

1. [Choose an instrument model](#). This configures the various settings to give you an appropriate starting point for the selected instrument model. It also sets you up with a group of Macro Controls that have been selected specifically for that instrument model.
2. Set up any combination of the three internal sound sources: two [FM oscillators](#) and a sample [WAV file](#).
3. Configure the [LFO](#), [Filters](#), [Envelopes](#), [Drum FX](#), and [general settings for the pad](#) from the Instrument Dashboard.
4. Configure the FX Sends for the pad on the [FX Sends screen](#).
5. Configure the effects parameters on the [three FX Settings screens](#). Note, that the FX1 and FX2 are bused effects. FX3 is a global effect.
6. Select values for the [Macro Controls](#) for each pad.
7. Adjust the pad level and pan on the [Mixer screen](#) to balance the levels of the 8 pads.

We have already covered numbers 4 through 7 earlier. We will cover numbers 1 through 3 in this section. You can choose a model from the Macro Controls screen or the Pad Dashboard. Push the Right Arrow from the Macro Controls screen to go to the Pad Dashboard. Here, you can configure the options listed in steps 2 and 3 above.

NAVIGATE AROUND THE PAD DASHBOARD

From the Pads Home Screen, push the Right Arrow button to get to the Macro Controls screen. Push the Right Arrow button again to go to the Pad Dashboard. From either the Macro Controls or the Pad Dashboard screen, touch the name of the pad in the header to access the Model Picker screen. On these two screens you can push the Layer button to advance to editing the next pad. From the Pad Dashboard, you can touch the Graphs at the top to access the FM Oscillator and WAV Management screens. Touch the buttons in the control bar along the bottom of the dashboard to go to the Filter, Envelope, LFO, Drum FX and Setup screens.

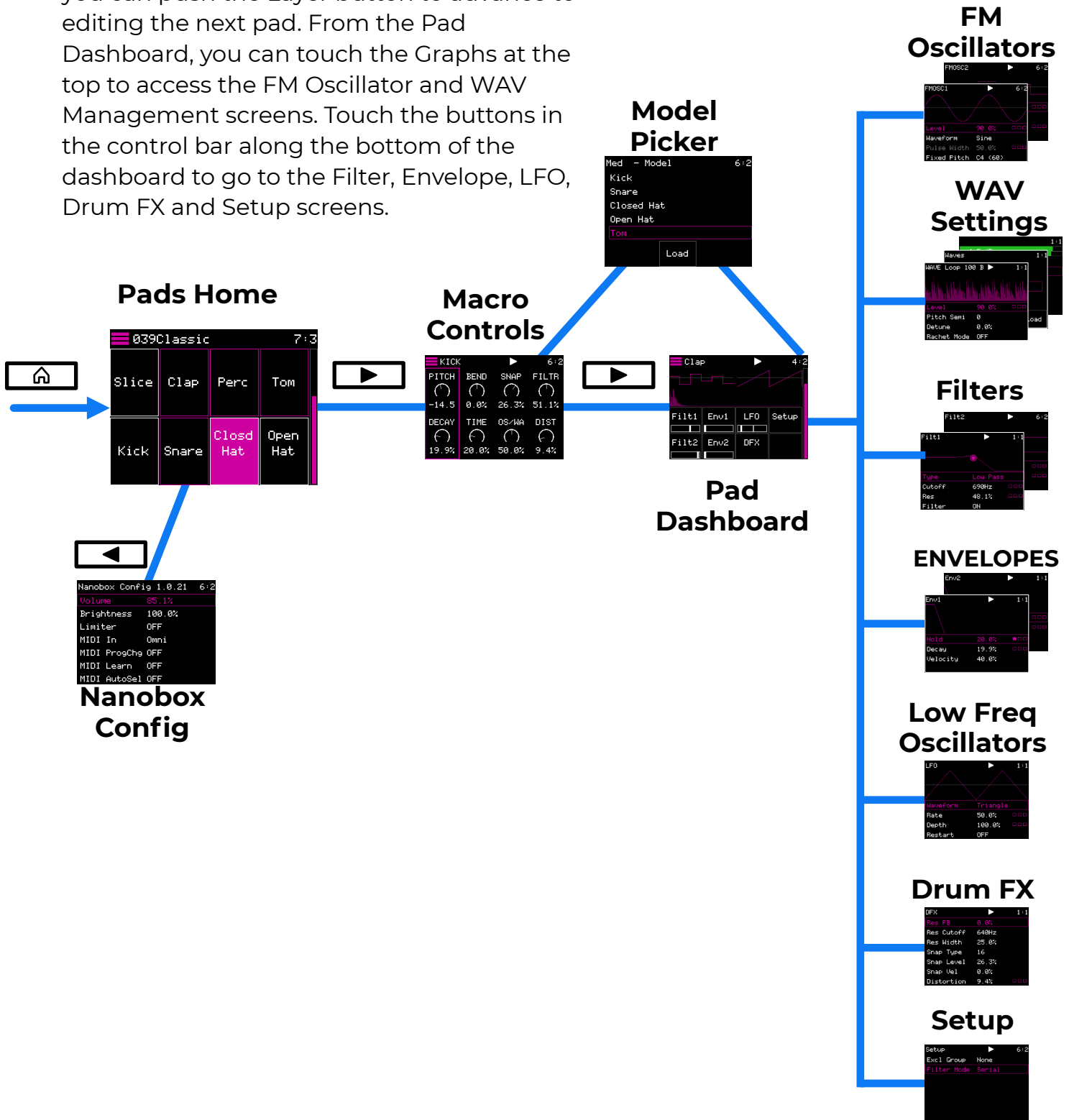

PAD MODELS

The Pad Models impact the pads in a few ways:

1. They adjust the settings for the pad to sound like a generic version of the selected model to give you a good starting point.
2. Nanobox | razzmatazz selects a set of parameters to display on the Macro Controls screen based on which model has been chosen. We covered this [mapping of controls to pad models](#) earlier. Now we will tell you how to choose a model for a pad.
3. If you choose Clip or Slicer model, a slightly different version of the Pad Dashboard is used.
4. [Clip and Slicer models](#) have some special behaviors that we will discuss later.

Available Models

The razzmatazz has 6 instrument models that are available for all pads:

- Kick
- Snare
- Closed Hat
- Open Hat
- Tom
- Sample

The top left pad can also support two additional models that support advanced WAV playback features:

- Clip
- Slicer

You use the same method to choose any of the 8 available models. Once you have chosen a model, the settings on the Macro Controls screen will be updated to reflect the model selected. The 6 common instrument models all use the same Pad Dashboard. The Clip and Slicer use a slightly different Pad Dashboard.

How to Select a Pad Model

1. From the Macro Controls screen or the Pad Dashboard, touch the pad name in the header to open the Model Picker screen.
2. Turn one of the knobs to select a model. You will hear a brief preview of each model as you scroll through the list. There is no preview for Sample, Clip, or Slicer, because these models depend on a WAV file.
3. Touch the Load button to confirm your selection. This will apply the default settings for the selected model to this pad and update the set of controls available on the Macro Controls screen for this pad.

PAD NAME

Touch to open the Model Picker.

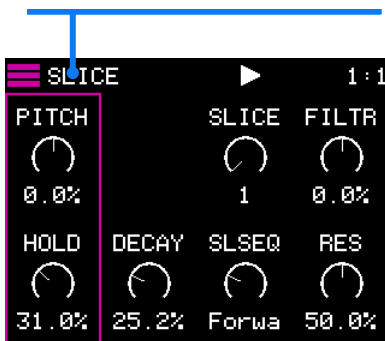

Macro Controls

PAD NAME

Touch to open the Model Picker.



Pad Dashboard

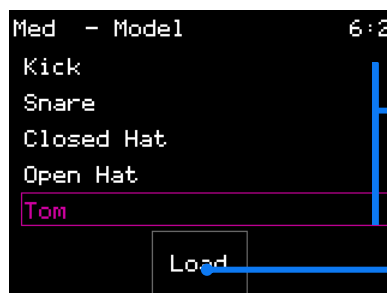

Model Picker

Selecting a model will update the settings of the pad to the defaults for that model and remove the WAV file mapping.

THE PAD DASHBOARD

From the Pad Dashboard you can access the settings used to craft the sound of a pad. We will start by discussing the Pad Dashboard for the 6 common instrument models.

Touch one of the graphs at the top of the dashboard to edit the settings for the corresponding oscillator or WAV file. Touch the buttons along the bottom of the dashboard to edit more related settings. The graphs below the buttons represent the current state of the setting and will move during a triggered event to show how the values are changing over time.

You can turn the top knob to adjust the pad level, as shown by the bar graph along the right side of the screen. Touch the Triangle in the header to trigger the pad to hear the results of your changes. The triangle will flash when this pad is triggered via MIDI or the sequencer.

Push the Layer button to cycle through the 8 pads. The name of the current pad is displayed in the header.

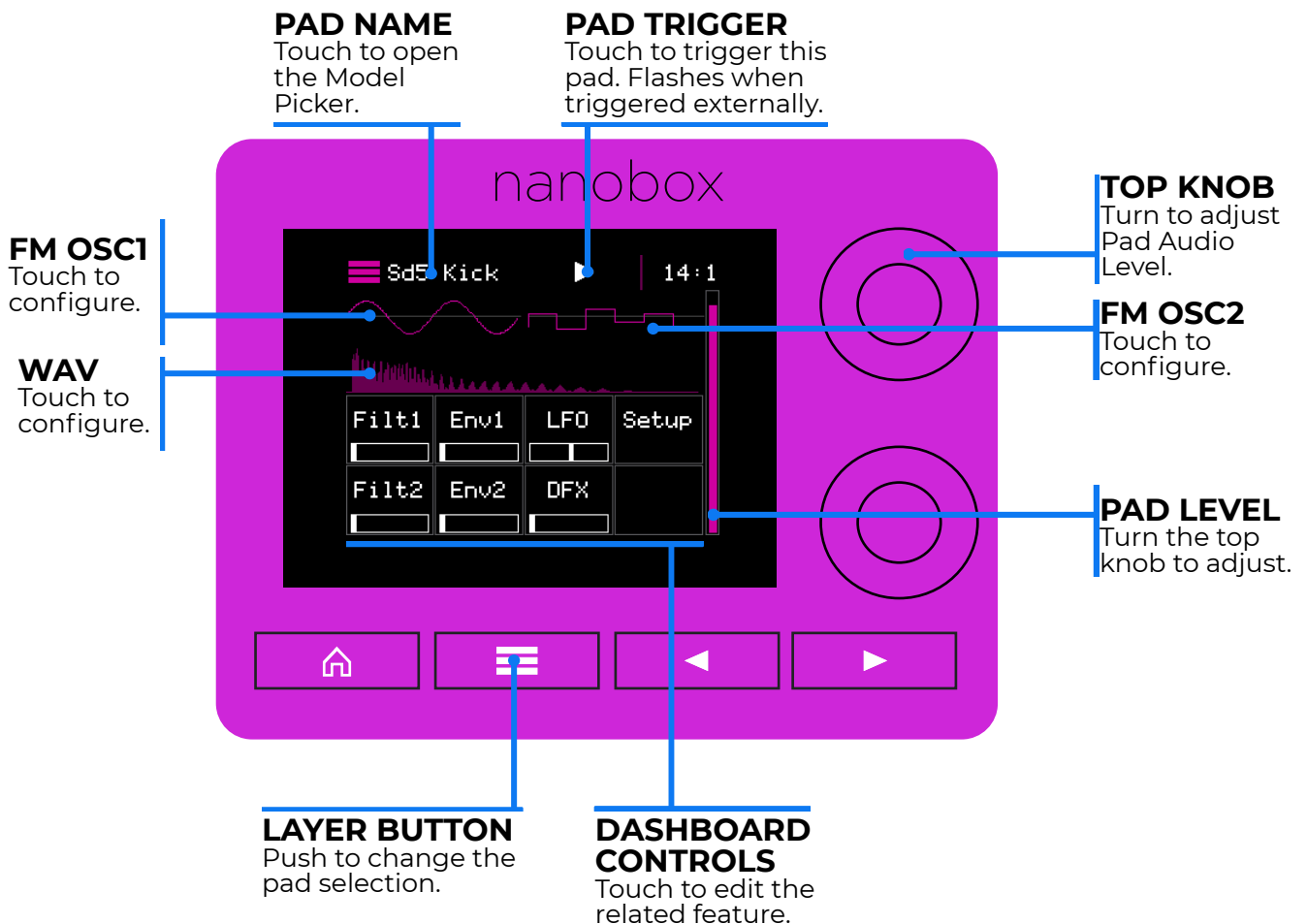

FM OSCILLATOR SOUND SOURCES

You can use two frequency modulated oscillators with most of the razzmatazz instrument models. Only the Clip and Slicer models do not support FM Oscillators. You can use either oscillator alone, use them both together, or use neither oscillator and let the WAV file do all the work. You can use the oscillators with or without a WAV source. If you do not want to use an oscillator, set the Level to 0.0%.

Configure the FM Oscillators

Touch an FM Oscillator graph on the Pad Dashboard to edit the related settings. Turn the top knob to select a parameter, and then turn the button knob to select a value. The pad trigger icon is available here to show when the pad is triggered or to trigger it to hear your changes. The table on the next page describes the available options. The parameters are the same for both oscillators.

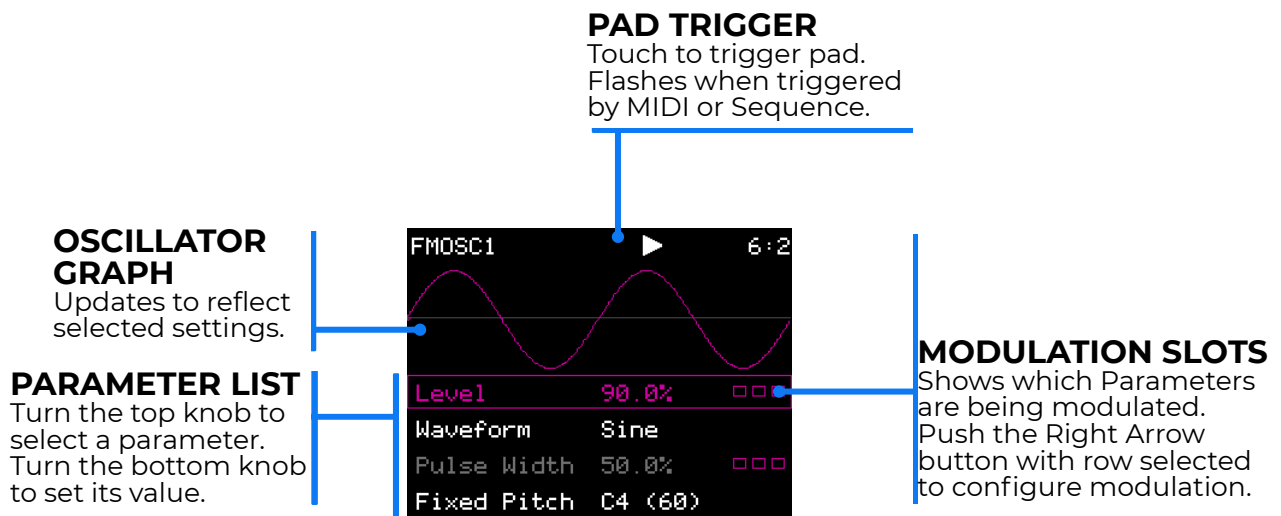

Push the Layer button to cycle between FMOSC1, FMOSC2 and WAV screens.

FM Oscillator Parameters

Parameter	Description	Modulation Target?
Level	The overall volume level of the output of this Oscillator. Range: 0 to 100%	Yes
Waveform	The shape of the carrier signal for this oscillator. Options: Noise, Sine, Square, Triangle, and Saw	No
Pulse Width	If Waveform is Square, this controls the width of the pulses. Range: 0 to 100%, where 100% is equivalent to one full cycle, meaning always high.	Yes
Fixed Pitch	The base pitch of the carrier wave, in notes. If the Waveform is Noise, this will not have any affect. Range: C#-1 (MIDI 1) through G9 (MIDI 127).	No
Detune	The amount the pitch should be offset from the Fixed Pitch. If the Waveform is Noise, this will not have any affect. Range: -100.00% to 100.0%, where 100% is equivalent to one semitone.	No
St Phase	The starting phase of the carrier wave. Does the WAV start at 0, at the peak, or somewhere in between? Range: 0 to 100%, where 100% is equivalent to 360 degrees, or one full cycle.	No

Parameter	Description	Modulation Target?
FM Amount	<p>The amount of modulation the sine wave modulation signal will apply to the carrier wave. Modulate the FM Amount to get interesting sounds.</p> <p>Range: 0 to 100%, where 100% is equivalent to the full scale.</p>	Yes
FM Ratio	<p>The difference in pitch or frequency between the carrier signal and the modulating sine wave. Multiply the frequency of the carrier signal by this number to get the frequency of the modulating wave. This is a coarse control for the modulation frequency.</p> <p>Range: 0.5 to 16</p>	No
Mod Pitch	<p>Fine control of the modulation frequency. This is used to detune the modulation wave.</p> <p>Range: -1.00 to +1.00, where +1.00 is one octave.</p>	Yes
FM Fbck	<p>The amount of the modulated signal that is fed back into, and combined with, the base carrier signal for modulation by the sine wave.</p> <p>Range: 0 to 100%, where 100% means the full output is fed back into the modulation.</p>	Yes

THE WAV SOUND SOURCE

You can add a WAV file as a sound source for all Pad Models. You can create some great drum sounds using just the two FM Oscillators, but the WAV file enables an additional range of sound capabilities. You can choose from 112 WAV files included in the Drums folder of the microSD card, or you can add your own WAV files to the card. We will talk about managing files on the microSD card later.

On the WAV screen, you can add a WAV file to a pad, remove a WAV file from a pad, configure the WAV file settings, and access the WAV recording feature.

Add or Change a WAV File Mapping

1. Touch the WAV graph on the Pad Dashboard to open the WAV Screen.
2. Touch the WAV graph area at the top of the screen, or push the Right Arrow button while the WAV file parameter is selected, to open the WAV Management screen.
3. Turn either knob to select a file or folder from the list. Touch the ^ and Load buttons to navigate up or down the folder tree. When the file you want is selected, touch Load to add the file to the pad. Any previous WAV file mapping is removed.

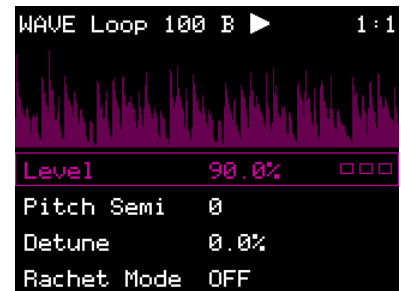

WAV Screen

Edit WAV Settings

1. Touch the WAV graph on the Pad Dashboard to open the WAV Screen.
2. Turn the top knob to select a parameter, then turn the bottom knob to set its value.

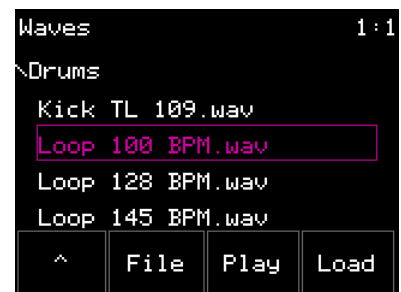

WAV Management

The table on the next page describes the available WAV parameters.

Renaming or moving a WAV file on the microSD card will break any WAV file mappings in presets.

The razzmatazz will only play the first 30 seconds of longer WAV files.

WAV Parameters

The table below describes the available WAV parameters.

Parameter	Description	Modulation Target?
Level	<p>The overall volume level of the output of this Oscillator.</p> <p>Does not apply to Clips or Slicers. Use the Pad Volume to adjust the level for these models.</p> <p>Range: 0 to 100%</p>	Yes
File	<p>The name of the WAV file mapped to this oscillator. Touch the waveform in the graph or push right arrow with this row selected to choose a WAV file.</p>	No
Pitch Semi	<p>The amount of pitch adjustment that will be applied to the WAV, in semitones. Use this to make coarse adjustments to the pitch.</p> <p>Does not apply to Clips or Slicers.</p> <p>Range: -24 to +24</p>	No
Detune	<p>The amount of pitch adjustment that will be applied to the WAV, in percent of a semitone. Use this for fine adjustments of pitch.</p> <p>Does not apply to Clips or Slicers.</p> <p>Range: -100.00% to 100.0%, where 100% is equivalent to one semitone.</p>	No
Ratchet Mode	<p>Set to On to trigger the WAV file multiple times in rapid succession. Works with Ratch Count and Ratch Time to control the number of triggers and the time between them.</p> <p>Does not apply to Clips or Slicers.</p> <p>Options: On, Off</p>	No
Ratch Count	<p>When Ratchet Mode is On, how many copies of the WAV will be played when the pad is triggered.</p> <p>Does not apply to Clips or Slicers.</p> <p>Range: 1 to 8</p>	No
Spread	<p>When Ratchet Mode is On, how much time will be between the triggered layers. Set to 0 and they will all start at the same time. Choose higher numbers to delay the subsequent copies.</p> <p>Does not apply to Clips or Slicers.</p> <p>Range: 0 to 100% where 100% maps to 500 ms.</p>	No

Record a WAV

You can use the Line In jack on the razzmatazz to record a new WAV file for use in pads.

1. Connect the audio source to the Line In jack on the razzmatazz.
2. Touch the WAV graph on the Pad Dashboard to open the WAV Screen.
3. Touch the WAV graph area at the top of the screen, or push the Right Arrow button while the WAV file parameter is selected, to open the WAV Management screen.
4. On the WAV Management Screen, push the Right Arrow button to access the WAV Recording Settings.
5. Turn the top knob to select a parameter and the bottom to choose the desired setting.
6. Adjust the Gain parameter while playing the audio source to make sure the input signal bar graph across the top of the screen fills as much of the bar as possible while not going into the red zone. If the audio level is too low, the sample will sound too quiet compared to other samples. If the audio level is too high and the meter goes red, the recording could be distorted as a result of clipping.
7. When ready to record, touch the Record button on screen.
8. If RecThresh is set to ON, recording will wait to start until the threshold level is reached. While recording, you will see the recording progress in Bars: Beats and seconds, along with the name of the file. Touch Stop when you are finished recording.

When recording ends, the file is saved in the \Recording folder on the microSD card as a .WAV file. This file is assigned to the current pad and you are back on the WAV screen. The recordings are named RecNNNN.wav where NNNN is a sequential four digit number.

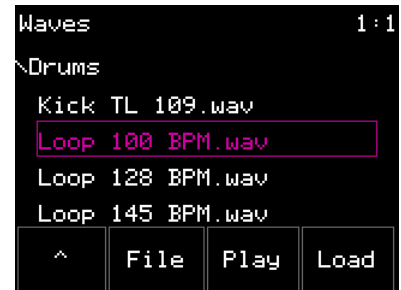

WAV Management

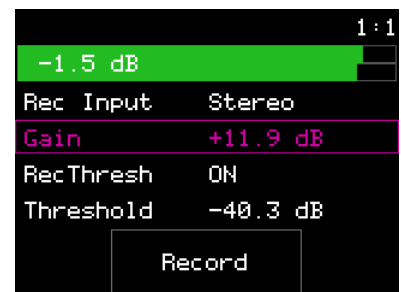

WAV Recording Settings

Remove a WAV from a Pad

If you decide you no longer want to use a WAV with a pad, you can unload the WAV file.

1. Touch the WAV graph on the Pad Dashboard to open the WAV Screen.
2. Touch the WAV graph area at the top of the screen, or push the Right Arrow button while the WAV file parameter is selected, to open the WAV Management screen.
3. On the WAV Management Screen, touch File and then Unload.

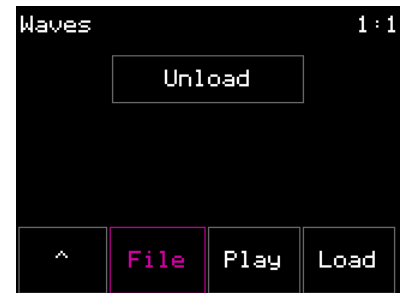

WAV File Menu

The mapping to the WAV file is removed from the pad.

PAD PITCH CONTROLS

There are a few different places to adjust the pitch of a pad. The FM Oscillators each have a Fixed Pitch and Detune parameter. The Fixed Pitch parameter allows you to tune the oscillator to a standard note on the scale. You can then nudge the pitch away from the base note using the Detune parameter.

The WAV sound source gets its base pitch from the WAV file itself. You can then adjust the pitch in full semitones using the Pitch Semi parameter. You can further refine the pitch using the Detune parameter.

On the Macro controls screen, there is a Pitch knob. This knob is designed to allow for fine-tuning the pitch of the final sound resulting from all three sound sources.

Note that the Noise Oscillator cannot be pitched. Any changes to pitch settings will not impact an FM Oscillator that uses the Noise waveform.

FILTERS

There are two Filters available for each pad. Touch a Filter button on the Pad Dashboard to edit the filter's setting for the currently selected pad. Make sure the Filter is set to ON to hear and see the settings take effect. You can choose how the Filters are applied on the [Pad Setup](#) screen. The available options are Serial, Parallel, and Per Osc. In [Serial mode](#), Filter 1 is applied first, and then Filter 2 is applied to the output of Filter 1. In [Parallel mode](#), each filter is applied independently and the results are then combined. In [Per Osc mode](#), Filter 1 is applied to FM Oscillator 1, and Filter 2 is applied to FM Oscillator 2. See the Voice Architecture diagrams below to see the details of when the Filters are applied for each mode.

Adjust Filter Settings

Touch Filt1 or Filt2 on the Pad Dashboard to open the Filter screen.

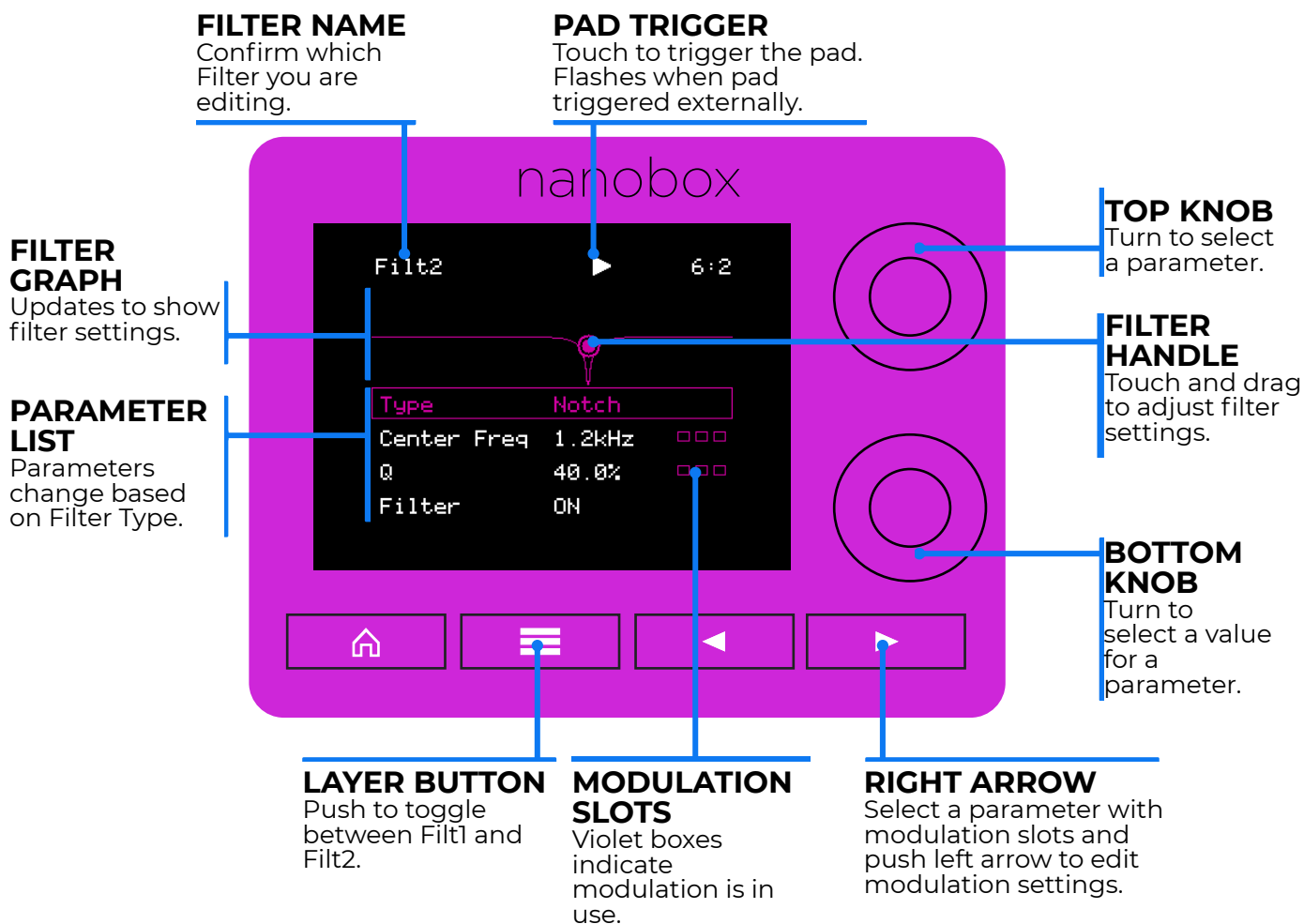

Set Filter to ON to enable the filter for this pad.

Filter Parameters

Parameter	Description	Modulation Target?
Type	<p>The type of filter that will be applied. See the Voice Architecture Diagrams and Setup Filter Mode parameter for more information about how filters are applied.</p> <p>Options: Low Pass, High Pass, Band Pass, or Notch.</p>	No
Cutoff	<p>For Low Pass filters, only frequencies below this value will pass through the filter. For High Pass filters, only frequencies above this value will pass through the filter.</p> <p>Range: 20 Hz to 20.4 kHz</p>	Yes
Resonance	<p>For High Pass and Low Pass filters, controls the shape of the frequency response near the cutoff frequency.</p> <p>Range: 0% to 100%</p>	Yes
Center Freq	<p>For Notch and Band Pass filters, the frequency at the middle of the notch or band. This is the frequency that will be most attenuated.</p> <p>Range: 20 Hz to 20.4 kHz</p>	Yes
Width	<p>For Band Pass filters, the width of the frequency range around the center point included in the notch or band.</p> <p>Range: 0% to 100%</p>	Yes
Q	<p>For Notch filters, Q controls the level of attenuation at and around the center frequency.</p> <p>Range: 0% to 100%</p>	Yes
Filter	<p>Turns the filter On and Off.</p> <p>Options: On, Off</p>	No

ENVELOPES

Each pad has two configurable Envelopes. Envelope 1 controls the amplitude of the pad's signal. Envelopes 1 and 2 can be assigned as a modulation source for Oscillator, Filter, LFO and DFX parameters for this pad.

Adjust Envelope Settings

From the Pad Dashboard, touch the ENV1 or ENV2 button to adjust the Envelope settings. You can toggle between the two Envelopes by pushing the Layer button.

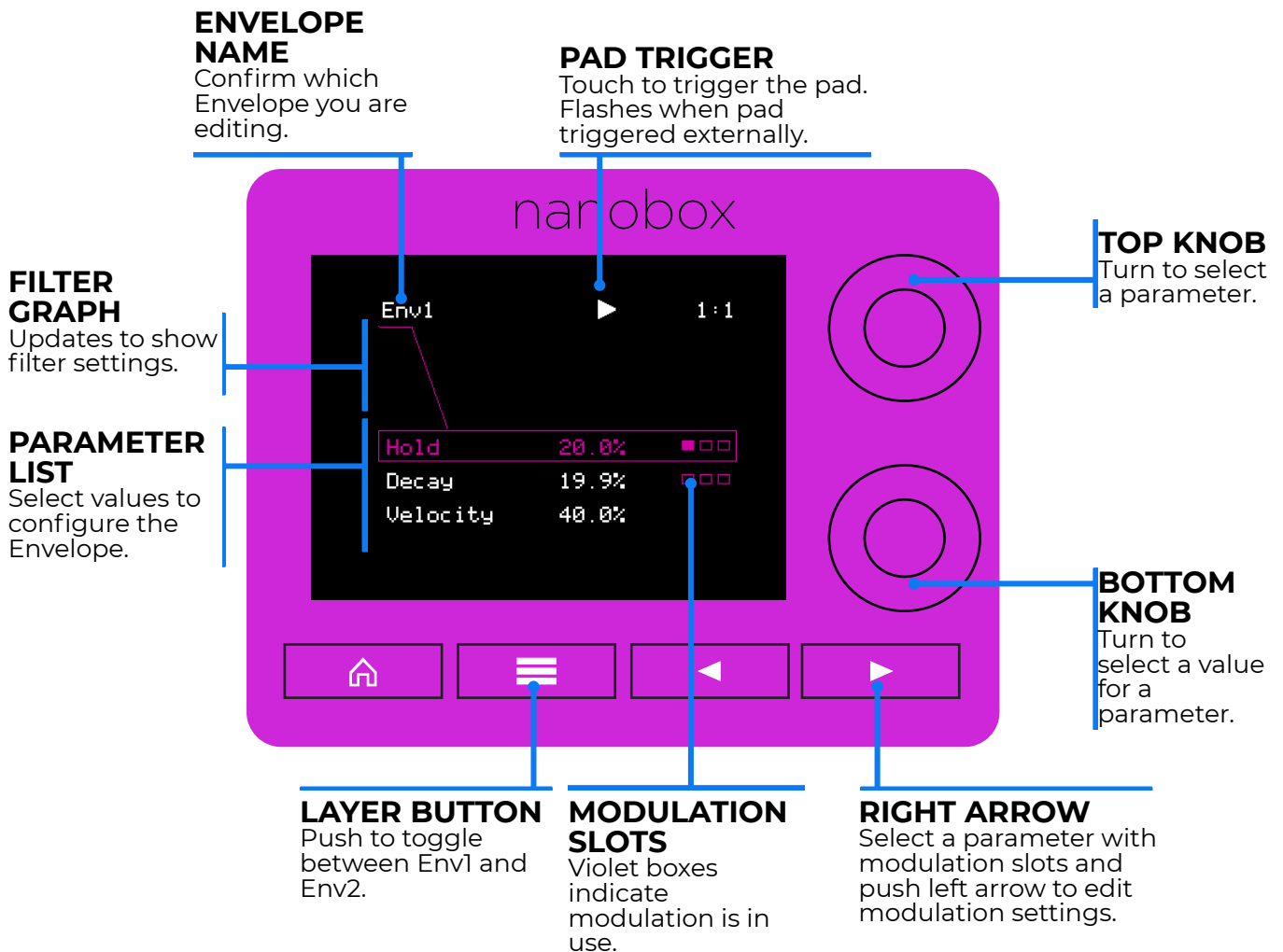

Envelope 1 and 2 Parameters

The table below lists the parameters that apply to ENV1 and ENV2. If the sound is getting cut short when you trigger a pad, increase the Hold.

Parameter	Description	Modulation Target?
Hold	How long the oscillators and WAV will play. Set to 100% to hold the pad infinitely. Range: 0% to 100%	Yes
Decay	How long it will take for the level to drop to zero after the hold time is over. Range: 0% to 100%	Yes
Velocity	How much of an impact the trigger velocity will have on the playback level of the pad. If the value is negative, increases in velocity will lower the playback level of the pad. Range: -100% to 100%	No

LOW FREQUENCY OSCILLATOR

Each pad has one Low Frequency Oscillator (LFO) that can be used as a modulation source for Oscillator, Filter, LFO and DFX parameters for this pad. The LFO can be used in this way to add dynamics to the sound by varying the modulated parameter over time.

Adjust LFO Settings

From the Pad Dashboard, touch the LFO button to adjust the LFO settings.

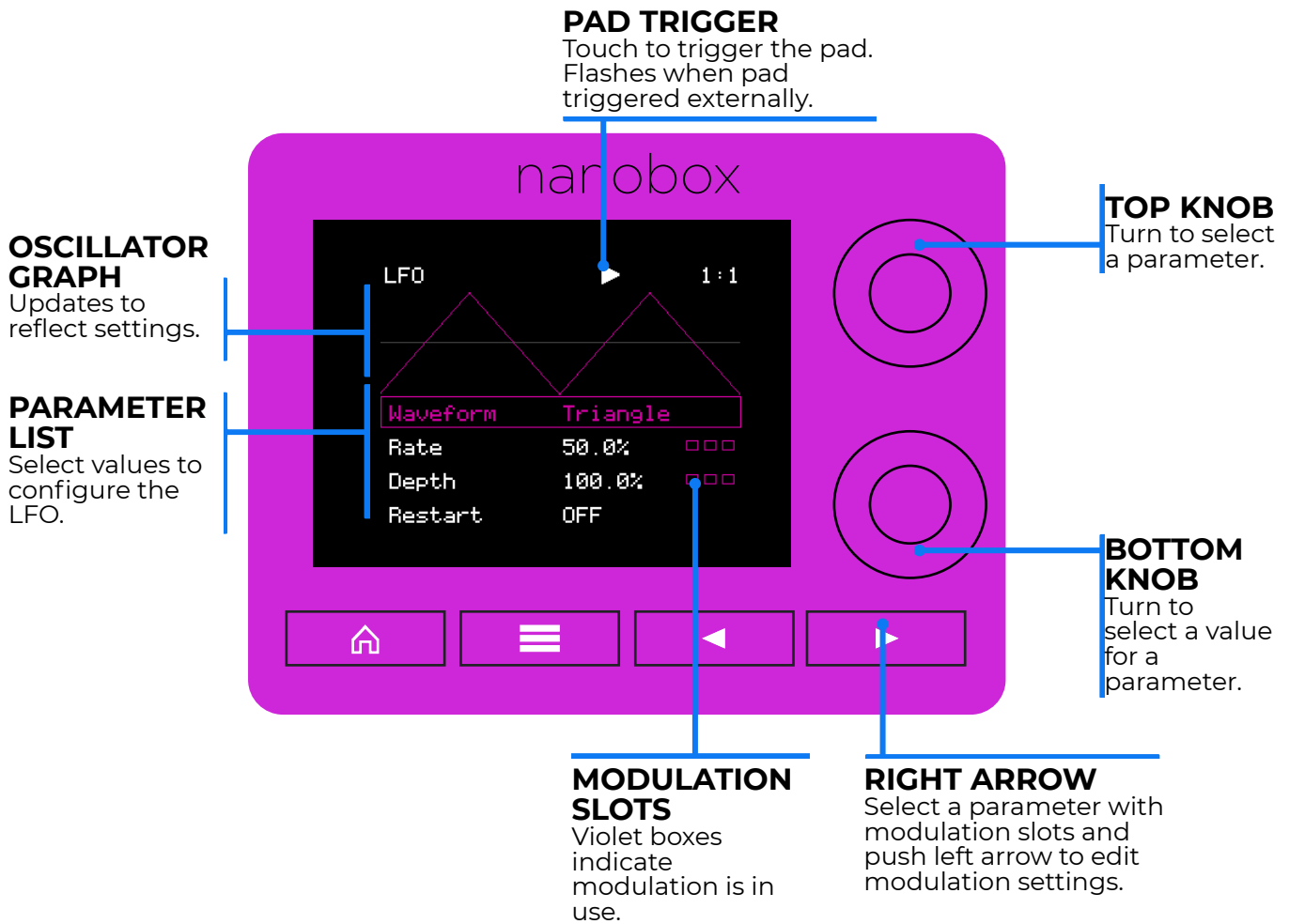

LFO Parameters

The table below explains the LFO parameters. Use these settings to create a signal that can be used to add variety to other pad parameters that support modulation.

Parameter	Description and Range	Modulation Target?
Waveform	The shape of the wave used by the low frequency oscillator. Options: Saw, Rev Saw, Triangle, Pos Tri, Sine, Pos Sine, Square, Pos Square, Random	No
Rate	The frequency of the LFO from about 0.1Hz to 12 Hz. Range: 0.0% to 100.0% When Beat Sync is On, this specifies the rate in beats and measure: Options: 8, 4, 2, 1, ½, ½ T, ¼, ¼ T, 1/8, 1/8 T, 1/16, 1/16 T, 1/32, 1/32 T, 1/64 bars	Yes
Depth	The amplitude of the oscillating wave. Set this to 0 to disable the LFO. Range: 0 to 100%	Yes
Restart	When active, the LFO will restart each time the pad is triggered. Options: On/Off	No
Beat Sync	Controls the operation of the rate parameter. When On, the wave cycle is synchronized with the clock. Options: On/Off	No

DRUM EFFECTS

On the Drum Effects (DFX) screen, you can configure several different effects to generate a broader range of sounds. Here, you can:

- Amplify the sound in a specified frequency range by applying resonance
- Add a sharp snap to the start of the sound
- Apply distortion to get a grittier sound
- Generate low-fidelity sounds with Bit Crushing and Rate Crushing effects

Adjust DFX Settings

Touch the DFX button on the Pad Dashboard to access the settings for the drum effects.

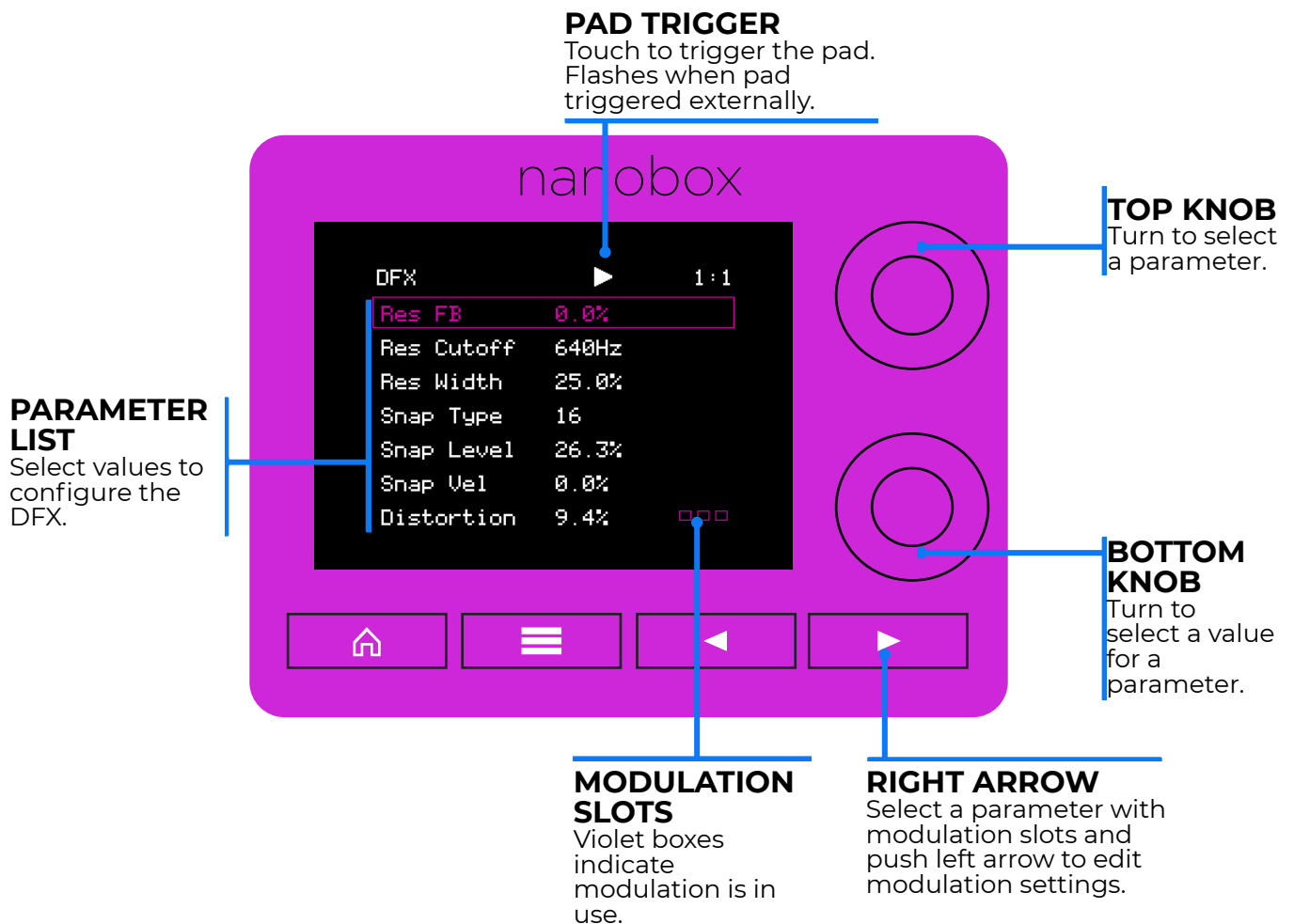

DFX Parameters

The table below (continued on the next page) lists the DFX settings. The [Voice Architecture](#) diagrams later in this document show how these settings fit into the signal chain.

Parameter	Description	Modulation Target?
Res FB	The amount of feedback used in the resonator effect for the pad. Range: 0 to 200%	No
Res Cutoff	Frequencies below this cutoff level will not be included in the resonator. Range: 0 to 100%, where 0% is 20 Hz and 100% is 20 kHz.	No
Res Width	The width of frequencies around the cutoff included in the resonator. Range: 0 to 100%, where 100% is equivalent to the full bandwidth.	No
Snap Type	Snap is another sound source added to the pad signal. The Snap Type represents the width of pulses in the snap, measured in samples. If "x 2" is at the end of the type, then the snap will have two pulses, each one the length of the width specified. Range: 1 through 64 x 2	No
Snap Level	The level of the signal used for the snap. Range: -100% to + 100%. Negative values will have an inverted pulse.	No
Snap Vel	Controls how much the note velocity impacts the level of the snap. When set to 0, the snap level will always be the same. When to 100%, the level of the snap will be adjusted up or down to the fullest extent based on the note velocity. Range: 0 to 100%	No

Parameter	Description	Modulation Target?
Distortion	The amount of distortion applied to the pad. Use distortion to simulate the imperfections of analog sound equipment that add grittiness to sound. Range: 0 to 100%	Yes
Bit Crush	The Bit Crusher effect simulates a reduced number of bits used to store samples. The higher the number, the fewer the bits.	Yes
Rate Crush	The Rate Crush simulates a reduced sampling frequency. The higher the number, the lower the sampling frequency.	Yes

PAD SETUP OPTIONS

On the Pad Setup screen, you can assign pads to Exclusive Groups so that a trigger on one pad will force the end of the sound on another. You can also choose which filter mode will be used. See the previous section on Filters for more information about filter mode. See the Voice Architecture diagrams below to see how the Filter mode, DFX, FX Sends and Envelope work together to generate interesting sounds. There are also a couple of options specific to Slicer and Clip pads.

Choose Pad Setup Options

Touch the Setup button the Pad Dashboard to configure the setup options for a pad. The list of options will vary based on the Pad Model.

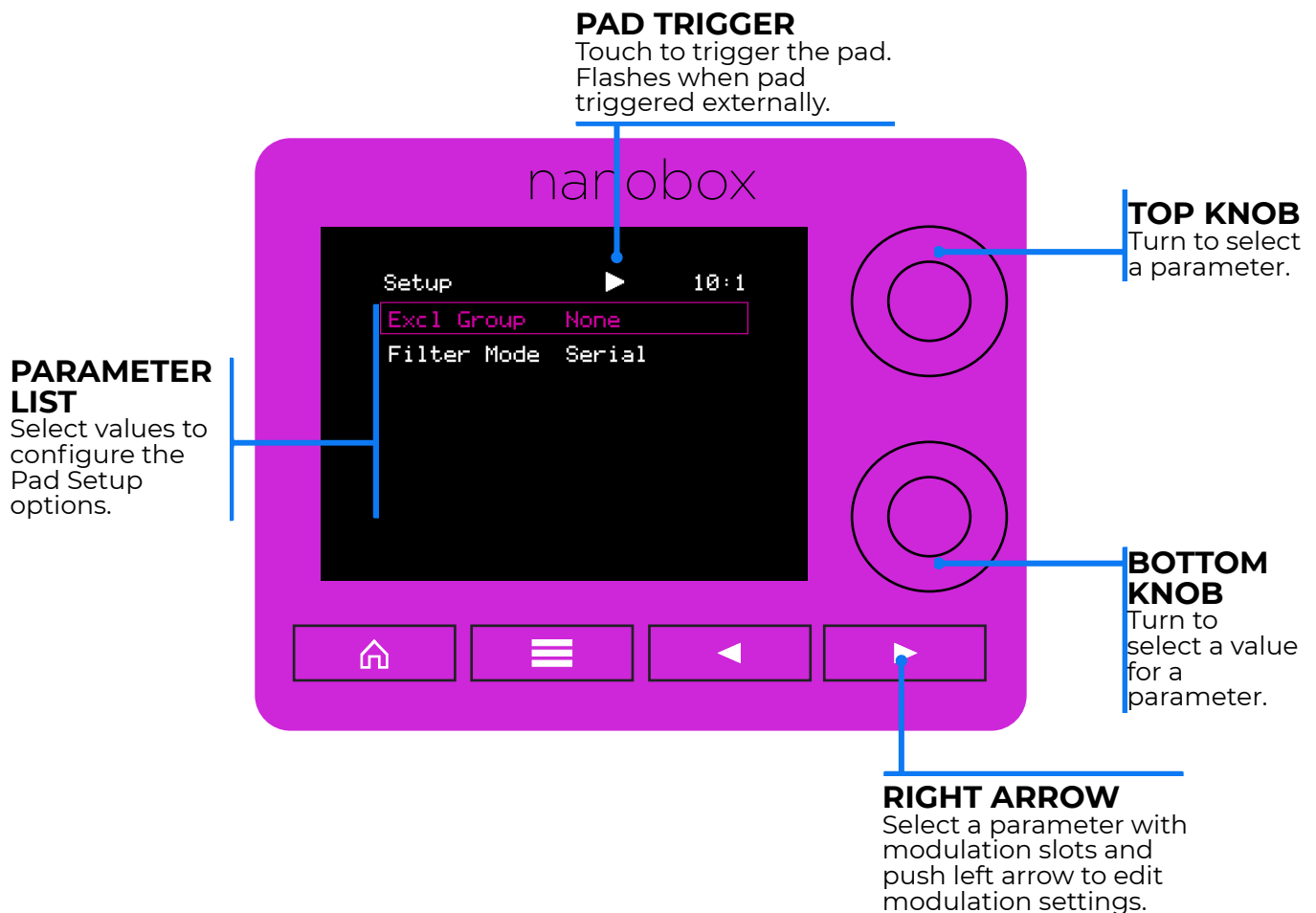

Available Pad Setup Options

The table below describes the Pad Setup options. Not all options apply to all pad models.

Parameter	Description	Modulation Target?
Excl Group	<p>Exclusive Grouping. Triggering a pad assigned to an exclusive group will cause any other pad in that group to stop playing.</p> <p>Options: None, Group A, Group B, Group C or Group D</p>	No
Filter mode	<p>This controls when the filters are applied to the FM oscillators in this pad. See the voice architecture to get a detailed picture of where the filters are applied. Choose Serial if you want Filter 2 applied after Filter 1 is applied. Choose Parallel to apply each filter separately and then combine the result. Choose Per Osc to apply Filt 1 to FM Osc 1, and Filt 2 to FM Osc2. If you choose Per Osc, the Filter does not get applied to the WAV.</p> <p>Does not apply to Clips or Slicers.</p> <p>Options: Serial, Parallel, or Per Osc.</p>	No
Launch Mode	<p>When Launch Mode is Trigger, the clip will play through once each time it is triggered. When Launch Mode is Toggle, playback will continue until another trigger event is received for the clip. The progress bar on the clip pad will be gray when playing the last or only loop through the clip, and white otherwise.</p> <p>Applies to Clip pads only.</p> <p>Options: Trigger, Toggle</p>	No
Play Thru	<p>When Play Thru is On, the playback of the WAV will start at the currently selected slice, and continue to play until the end of the file. When Play Thru is Off, playback will end at the end of the current slice.</p> <p>Applies to Slicer pads only.</p> <p>Options: ON, OFF</p>	No

CLIPS AND SLICERS

The top left pad on the razzmatazz supports two additional instrument models: Clip and Slicer. Clips play back WAV files with beat synchronization and looping capabilities. Slicers can playback content of the WAV starting at different times in the WAV as identified by slice markers. Each of these models requires the use of WAV files that have previously been prepared for such use on a different device.

Pad Dashboard for Clips and Slicers

These two models generate sound using only a WAV file. As a result, the Pad Dashboard is much simpler for these models as shown below.

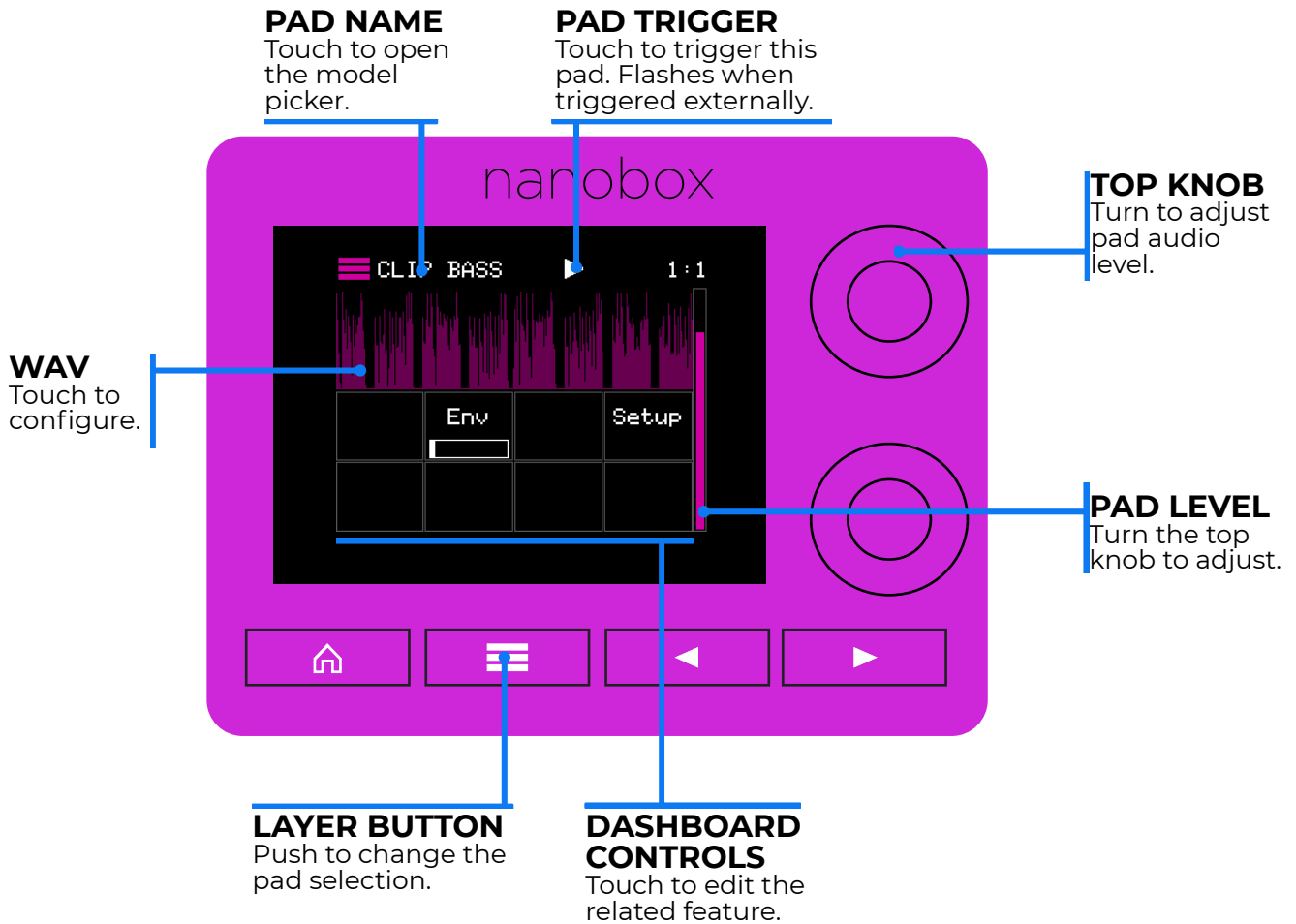

Clip Features

Clip pads can support looping playback and beat synchronized playback. They are useful to play a track along with your sequence or finger drumming. Check out the Demo3Clip factory preset to see a clip in action.

See the WAV, Macro Controls, Envelope and Setup sections to read about the clip specific settings on those screens. The Quant and Sync settings on the Macro Controls screen, and the Launch Mode setting on the Setup Screen are particularly important for clips.

For clips and slices, it is important to use the Envelope to control how much of the clip or slice is played and how it fades out.

Clips can only play when the clock is running because they need to synchronize with it. When you trigger a clip, a white progress bar appears across the bottom of the pad. The progress bar does not move and the clip does not play until the transports are playing. Touch the clock and then push Play on the Transports pop-up to start the clip playing.

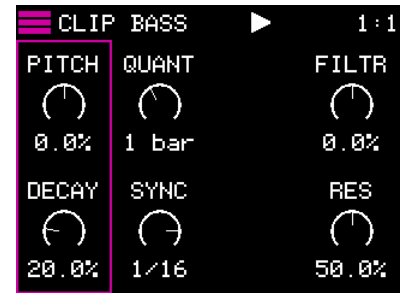

**Macro Controls
for Clips**

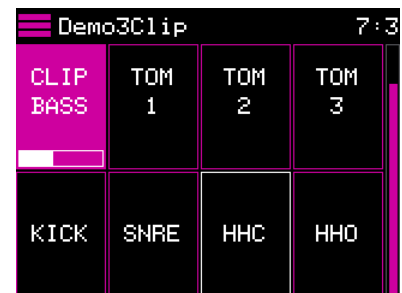

Playing Clip Pad

Clip File Requirements

To be compatible with the Clip model, a WAV must meet the following criteria:

- There can be no extra blank space at the beginning or end of the file.
- The file must be created so that if you play consecutive copies it will sound like a loop.
- The length of the audio should be a full number of bars.
- The tempo of the audio must be within about 20 BPM of the desired playback tempo. If you try to play it back at a much different tempo, you may hear artifacts.
- Must meet the standard nanobox [WAV file requirements](#).

Slicer Features

Slicer pads can play individual slices of a WAV file. You can choose to have successive slices played for each trigger, play the same slice each trigger, or have random slices play each time. Check out the Demo2Slice preset to hear the slicer model at work.

See the [WAV](#), [Macro Controls](#), [Envelope](#) and [Setup](#) sections to read about the slicer specific settings on those screens. The Slice and SLSeq parameters on the Macro Controls screen, and the PlayThru option on the Setup screen, are important for Slicer pads.

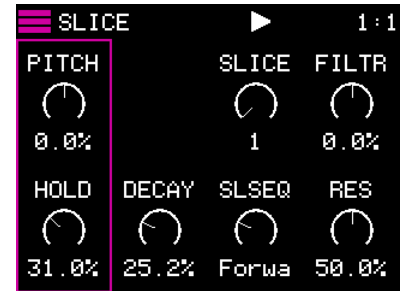

**Macro Controls
for Slicers**

Slicer File Requirements

To be compatible with the Slicer model, a WAV file must meet the following criteria:

- The WAV file must contain Slice Markers or Cue points. Sliced files created on blackbox are supported. You can also use the following software to create slice files:
 - Reaper for Windows/Mac/Linux - <https://www.reaper.fm/>
 - OcenAudio for Windows/Mac/Linux - <https://www.ocenaudio.com/>
- The WAV file must meet the standard nanobox [WAV file requirements](#).

MANAGE PADS

The Hamburger Menu in the top left corner of the Pads Home, Macro Controls and Pad Dashboard screens has several options to help you manage your pads. From here, you can copy and paste pads within and across presets, change the onscreen label for the pad, save a pad to a file for re-use, and load a previously saved pad file.

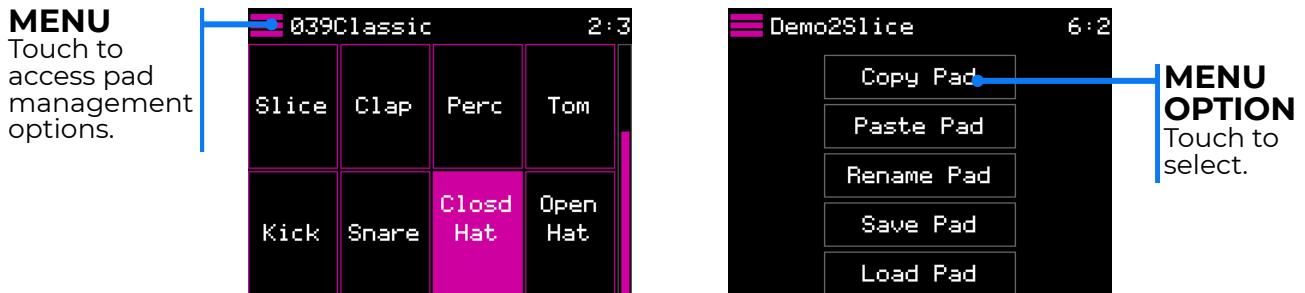

Copy and Paste a Pad

You don't have to start from scratch each time you create a pad. You can copy a pad that is close and make adjustments from there. You can also copy a pad from one preset to another for use in a different kit.

1. On the Pads Home screen, select the pad you want to copy.
2. Touch the Hamburger Menu in the top left corner of the Pads Home, Macro Controls, or Pad Dashboard screen.
3. Touch Copy Pad on the Pads menu. The pad information is now in the clipboard.
4. Select the pad where you want to paste. This can be in the same preset or a different preset.
5. Touch the Hamburger Menu, then touch Paste Pad. All of the source pad's settings, including pointers to WAV files, are copied to the target pad.

Change a Pad Label

You can use the Rename action to change the label that appears on the pad on the Pads Home screen and in the header of other pads screens.

1. On the Pads Home screen, select the pad you want to rename.
2. Touch the Hamburger Menu in the top left corner of the Pads Home, Macro Controls, or Pad Dashboard screen.
3. Touch Rename Pad on the Pads menu. The pad naming keyboard is displayed.
4. Use the keyboard to enter a new name.
5. Touch Enter when done. The pad label has now been changed.

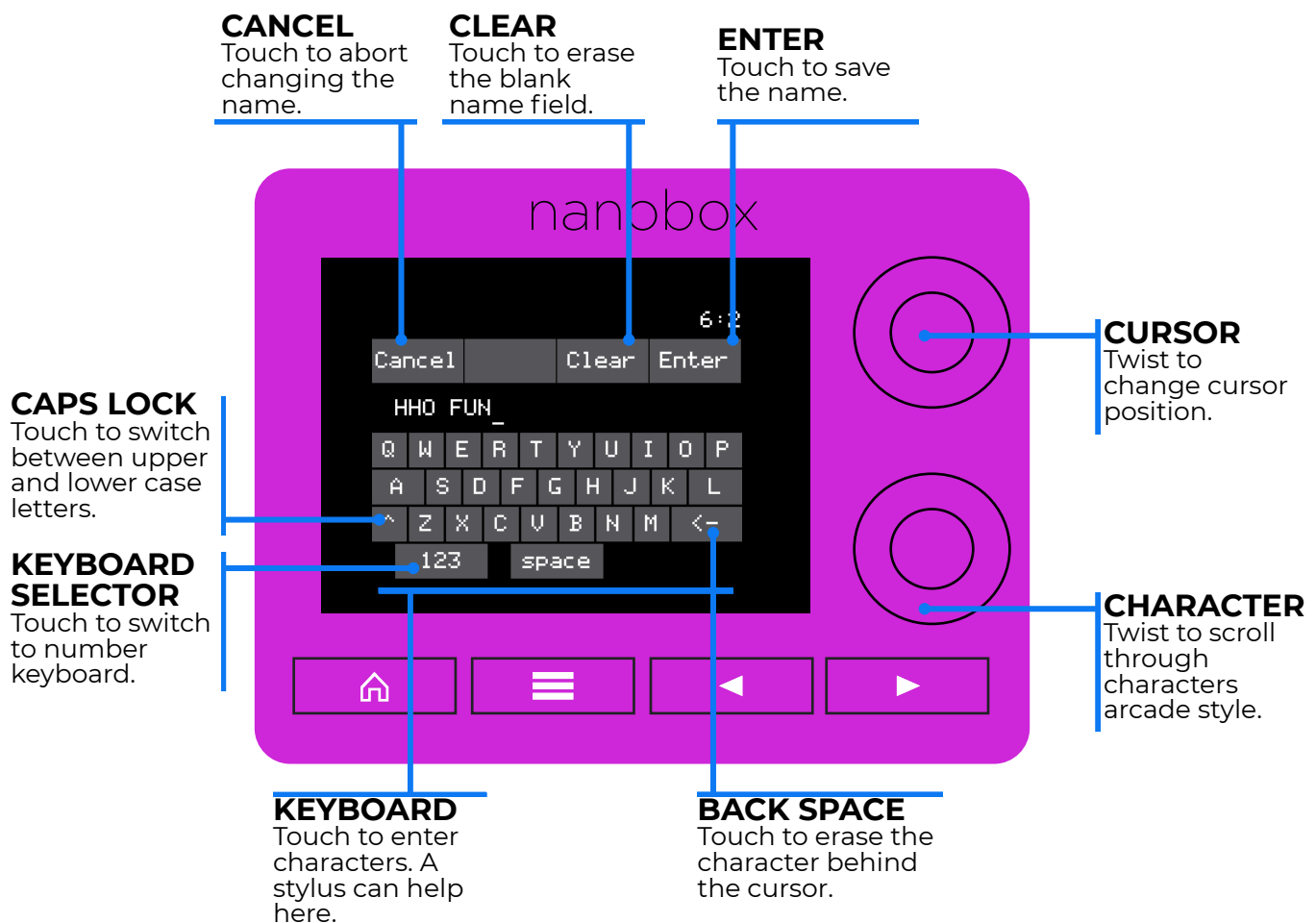

Save and Load Pads from the Pad Bank

On the 1010music forum, <https://forum.1010music.com>, you can find a set of Pad Preset files that you can put in the pad bank on your microSD card for use in presets. You can also save your own pad creations to the Pad Bank for future re-use.

The razzmatazz can save and load Pad Preset files in sub folders under the \Pads folder on the microSD card. The 1010music Pad Bank files are organized into folders. You can rename these and create your own folders, but they must be under the \Pads folder.

The razzmatazz can only access folders one level below \Pads to locate Pad Preset files. It cannot access additional folder levels below that. Put the microSD card in your computer to manage the folders.

When you load a pad, you are loading a copy of the pad information into the current preset. There is no connection to the file after that.

1. Select the pad you want to save to the Pad Bank.
2. Touch the Hamburger Menu on one of the pads screens, and then touch Save Pad. You will see the Pad Bank Save screen.
3. Turn a knob to select a folder, and then touch Save. The Pad File naming screen is shown.
4. Enter a name for the pad file. The file name on the microSD card will have this name with a .ndm extension. You will now be back on the screen where you started.
5. Now select the pad where you want to load a saved pad file. This can be the current preset or a new preset.
6. Touch the Hamburger Menu on one of the pads screens, and then touch Load Pad. You will see the Pad Bank Load screen with a list of folders.
7. Select a folder to load from and touch Load. You will see a list of files in the selected folder.
8. Select a file and touch Load. The selected pad file is now loaded into the current pad. This is a copy of the pad and is not linked to the saved file.

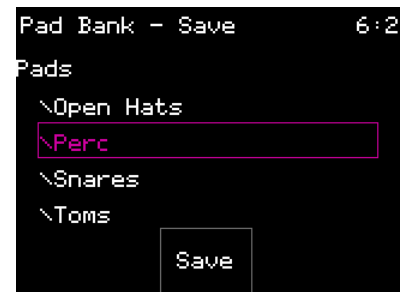

Pad Bank - Save



Pad Bank -
Load Folders

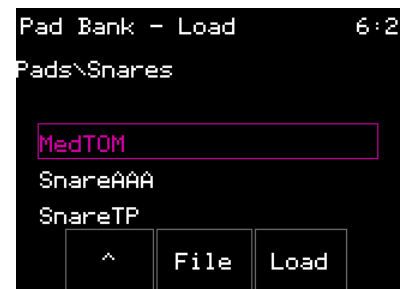

Pad Bank -
Load Files

Delete Files from the Pad Bank

You can delete pad files from the Pad Bank folders while you are in the Pad Loading screen.

1. Touch the Hamburger Menu on one of the pads screens, and then touch Load Pad. You will see the Pad Bank Load screen with a list of folders.
2. Select a folder and touch Load. You will see a list of files in the selected folder.
3. Select a file and touch File. You will see the Delete button.
4. Touch the Delete button. You will see a prompt confirming you want to delete. Touch OK to proceed with deleting the file. Push the left arrow button or touch anywhere else on the screen to cancel the delete.

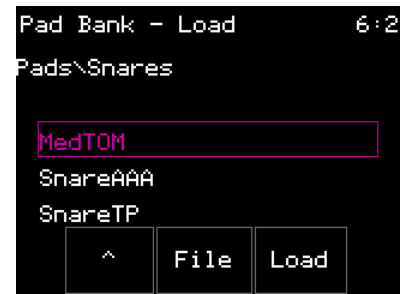

**Pad Bank - Load -
File Menu**

This process will delete the pad file from the microSD card. Once you touch OK on the confirmation screen, you cannot undo this action.

VOICE ARCHITECTURE

The diagrams below illustrate the signal path for each pad's voice. The outputs of these pads then feed into the [FX Voice Architecture](#) shown above. The signal path for the pads varies significantly based on the Filter Mode chosen on the [Pad Setup](#) screen. There is a diagram for each of these modes. There is also a separate diagram for Clip and Slicer mode pads.

SERIAL FILTER MODE

When Filter Mode is Serial, the output of Filter 1 provides the input to Filter 2.

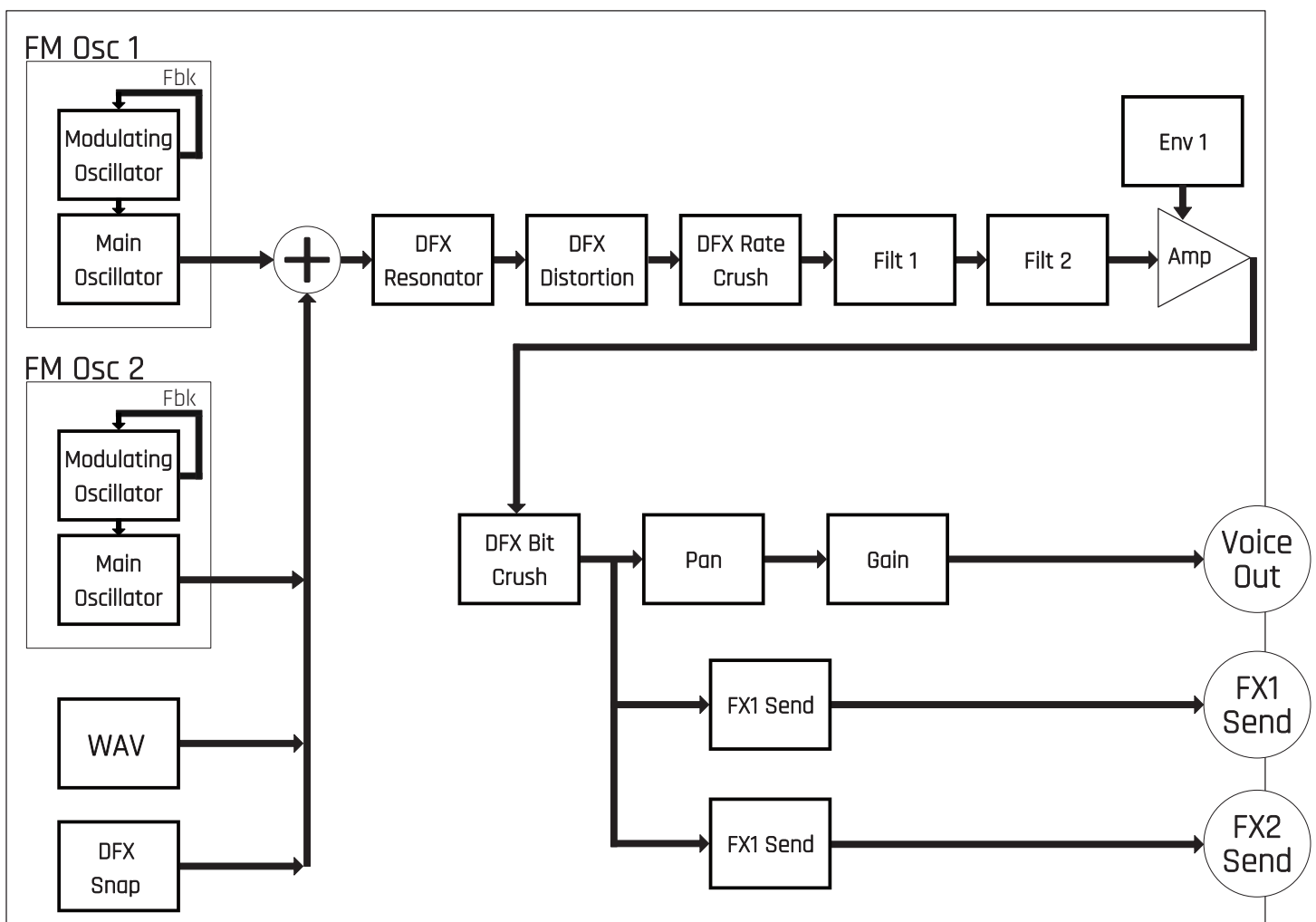

PARALLEL FILTER MODE

In Parallel Filter Mode, the output of the Rate Crusher is fed separately into Filter 1 and Filter 2. The two filters process the signal independently, and the outcome is then added together to feed into the Amplifier.

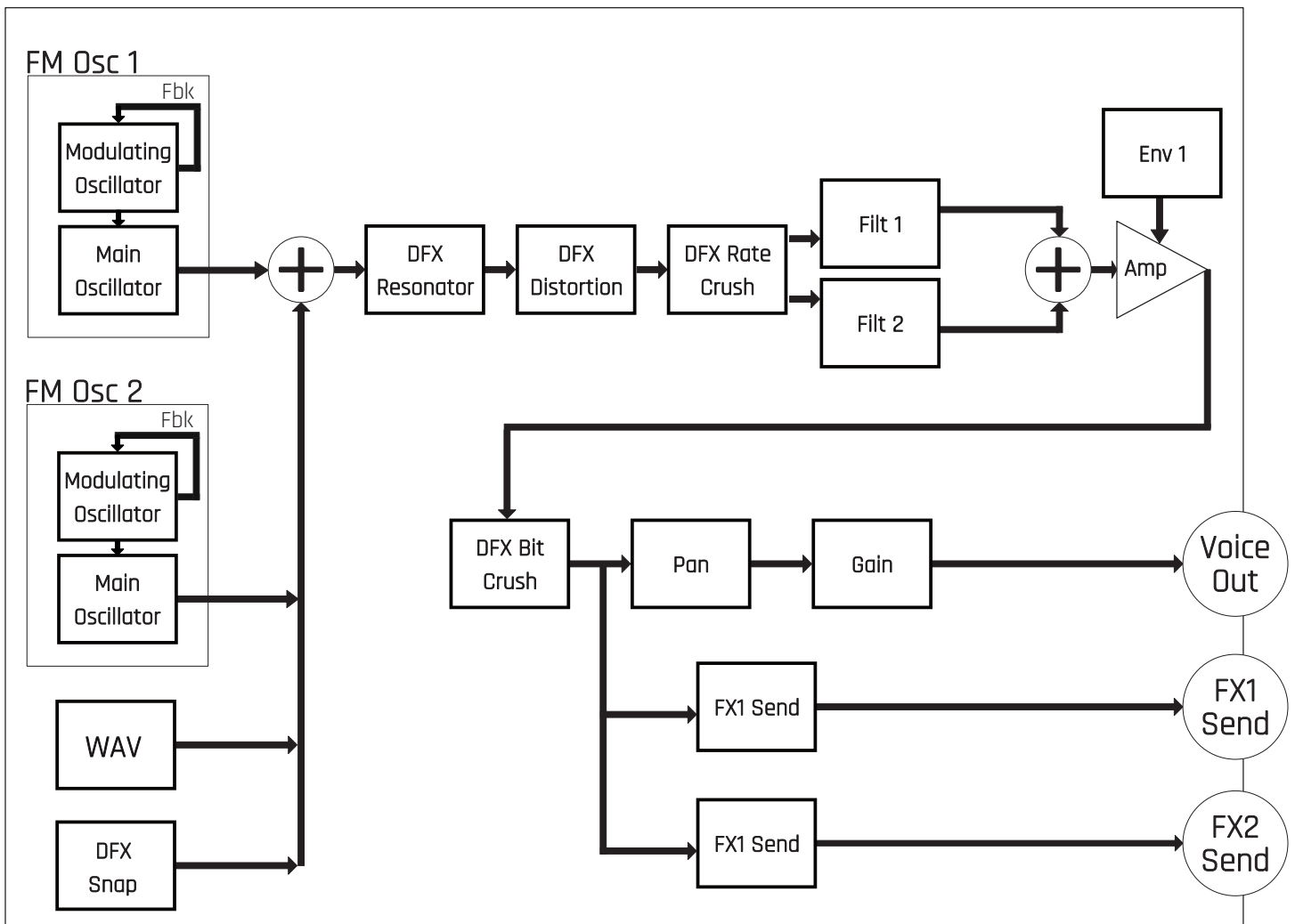

PER OSCILLATOR FILTER MODE

Set Filter Mode to Per Oscillator to apply Filter 1 to FM Oscillator 1 and Filter 2 to FM Oscillator 2.

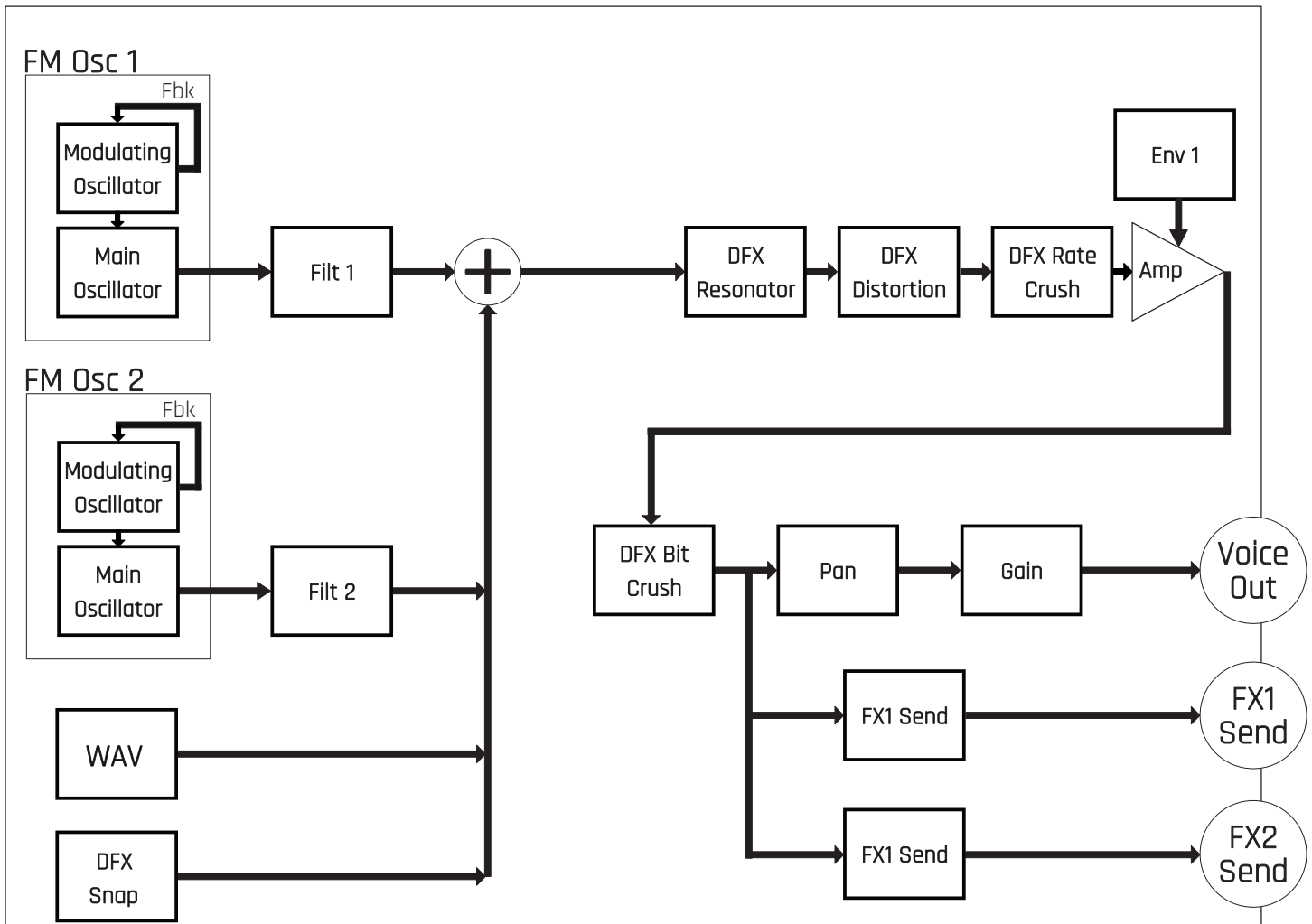

CLIP AND SLICER MODE

If the pad model is set to Clip or Slicer, the only audio source for the pad is the WAV file. For Clips, the Launch Mode will control whether the pad plays in a loop. For Slicer mode, the Play Thru setting controls whether the WAV file continues playing when it reaches the start of the next slice.

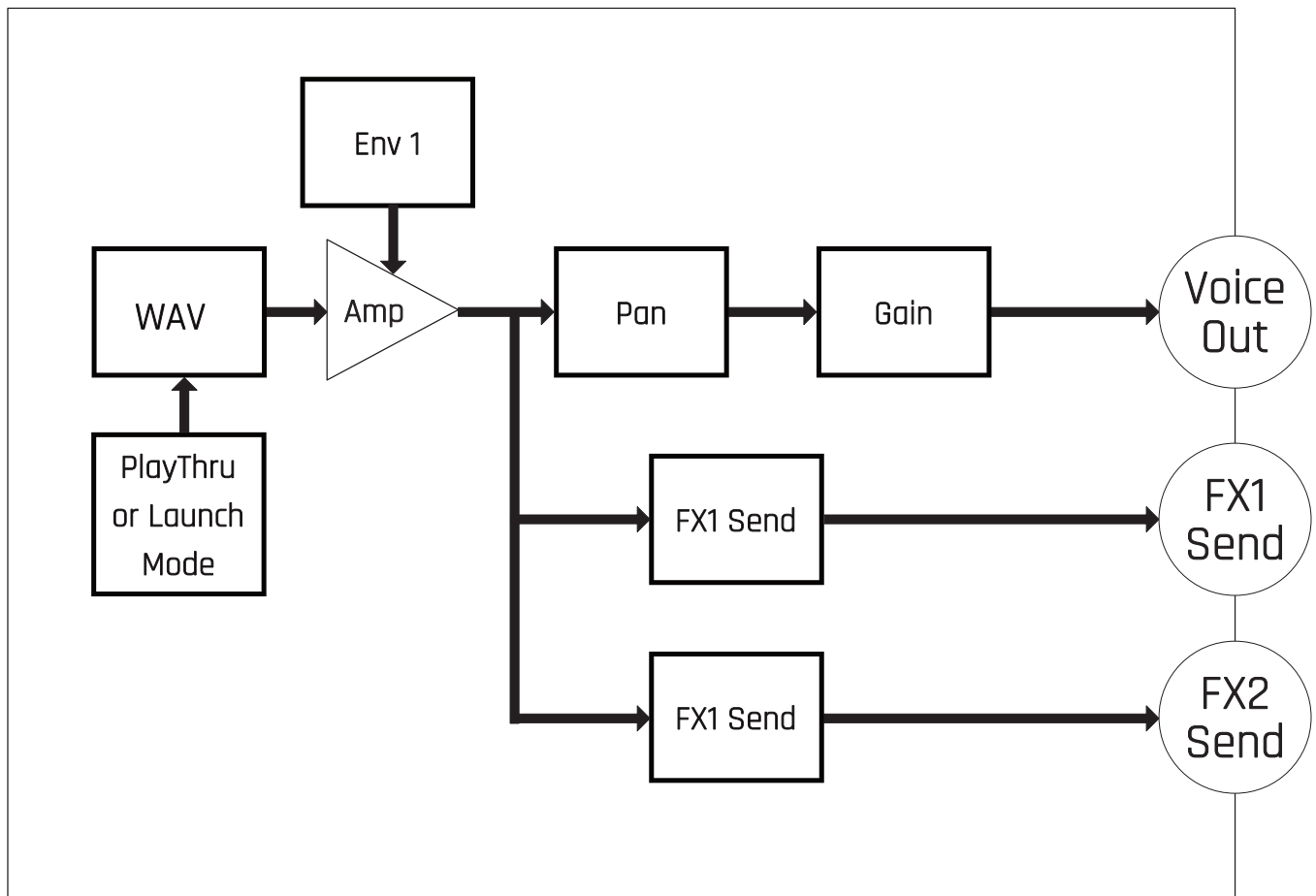

NANOBOX CONFIGURATION SETTINGS

The Nanobox Configuration screen has several options that apply to the razzmatazz as a whole. These options are defined in the table below (continued on the next page).

FIRMWARE VERSION

The number to the left of the clock on the Nanobox Configuration screen is the version of firmware that is running. Check the 1010music forum, <https://forum.1010music.com>, to see if there is a newer version available.

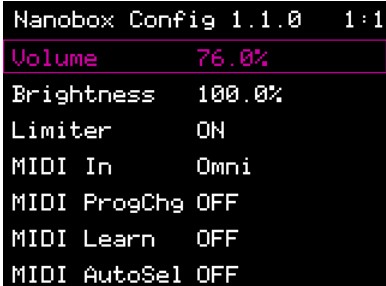

Nanobox Config 1.1.0 1:1	
Volume	76.0%
Brightness	100.0%
Limiter	ON
MIDI In	Omni
MIDI ProgChg	OFF
MIDI Learn	OFF
MIDI AutoSel	OFF

Nanobox Configuration

AVAILABLE NANOBOX SETTINGS

Parameter	Description
Volume	The volume of the audio output. Range: 0 to 100%
Brightness	The brightness of the touchscreen. Range: 0 to 100%
Limiter	When On, an audio compressor is applied to limit the Line Out signal to avoid clipping. Options: On, Off
MIDI In	The MIDI Channel that will be used to control the razzmatazz. Signals on other channels will be ignored. Set to Omni to respond to MIDI signals on all channels. Options: None, Ch 1 to 16, Omni
MIDI ProgChg	When set to ON, the razzmatazz will respond to MIDI Program change messages on the MIDI In channel by advancing to the corresponding preset. Presets are mapped to MIDI Channels in alphabetical order Options: On, Off
MIDI Learn	When set to On, the MIDI Learn function is enabled. This allows you to teach the razzmatazz how to respond to MIDI CC messages from external MIDI controllers. Be sure to turn this Off when done mapping in order to resume normal functioning. Options: On, Off

Parameter	Description
MIDI AutoSel	<p>When On, a MIDI note event within the range of notes mapped to pads will change which pad is selected for editing on the pad specific screens, such as the Pad Macro screen and Pad Dashboard. The current pad is named in the header of these screens.</p> <p>Options: On, Off</p>
Input Gain	<p>The amount of attenuation applied to the Line In signal before it is passed to the FX Chain.</p> <p>Range: -96.0 dB to + 19.8 dB.</p>
Input FX1	<p>The amount of the input signal that is sent to FX1 for processing.</p> <p>Range: 0 to 100%</p>
Input FX2	<p>The amount of the input signal that is sent to FX2 for processing.</p> <p>Range: 0 to 100%</p>
Line Input	<p>When set to Mono, razzmatazz will only use the signal on the left channel of the Line Input.</p> <p>Options: Stereo and Mono.</p>
Clock Input	<p>If you are synchronizing with an analog clock, the razzmatazz needs to know how many clock pulses to expect per quarter note. You can set that here.</p> <p>Options: 1, 2, 4, 8, 12 or 24 PPQ.</p>

USING A MIDI CONTROLLER

The razzmatazz is designed to work on its own, but when paired with a MIDI controller you can get more immediate access to the following features:

- MIDI triggered pads with velocity and pressure
- Changing presets with MIDI program changes
- MIDI modulation of parameters accessed through the Pad Dashboard
 - Velocity
 - Pressure
 - Mod Wheel
- MIDI CC control of the Macro Controls
- MIDI CC control of the Mixer settings
- MIDI CC control of the FX Sends
- Pass through MIDI to MIDI Out
- Optionally change pad selection in the UI when triggering via MIDI

MIDI HARDWARE CONNECTIONS

The razzmatazz MIDI In can be connected to devices that support TRS MIDI Type A or Type B. You can also use the included TRS MIDI Adapter to connect to MIDI 5 Pin DIN controllers. Be sure to use a TRS cable (not a TS cable) to connect to your MIDI Devices. TRS Cables have two black bands on the stem, while TS cables only have one.

The MIDI Out uses TRS Type B. You can use the included TRS adapter to connect to MIDI 5 Pin DIN controllers.

The razzmatazz does not support USB MIDI.



Connections



TRS Cable



MIDI Adapter

MIDI SETTINGS

By default, the razzmatazz is set to listen to all MIDI channels coming through the MIDI In port. You can set razzmatazz to respond to a single MIDI channel by setting the value of MIDI In on the [Nanobox Configuration](#) screen, as discussed above. Regardless of what is selected for MIDI In, all of the MIDI inputs received will be passed through to the MIDI Out so you can control several devices with one MIDI controller.

Check the [Nanobox Configuration](#) settings above for more details about the MIDI Program Change, MIDI Learn, and MIDI Auto Select options.

```
Nanobox Config 1.1.0 1:1
Volume 76.0%
Brightness 100.0%
Limiter ON
MIDI In Omni
MIDI ProgChg OFF
MIDI Learn OFF
MIDI AutoSel OFF
```

Nanobox Configuration

MIDI NOTE MESSAGES: PLAY THE PADS

You can use a MIDI controller to trigger pads. This could be an external MIDI sequencer, a MIDI keyboard, MIDI pads, or anything that can send MIDI Notes in the proper range. The razzmatazz can receive velocity and pressure information for each event trigger. Try the 013Velocity preset to see how the razzmatazz can use velocity to modify the sound of the pads.

Using pressure and velocity, MIDI triggering can add dynamics to the sound that are not available via live finger drumming on the touch screen. You can adjust note velocity for sequences recorded via finger drumming or via MIDI inputs. Sequences recorded via MIDI will record the velocity information for each trigger.

The table below shows which MIDI notes will trigger the pads. See the section on [Playing Pads](#) above for more details about triggering pads via MIDI.

E2 MIDI 40	F2 MIDI 41	F#2 MIDI 42	G2 MIDI 43
C2 MIDI 36	C#2 MIDI 37	D2 MIDI 38	D#2 MIDI 39

Pads MIDI Mapping

MIDI CONTROL CHANGE: CONTROL YOUR SETTINGS

You can teach the razzmatazz to respond to MIDI Control Change (CC) signals to set values for:

- Pad Macro Controls - one MIDI CC per pad per Macro Control
- MIXER Settings - Volume and Pan per pad
- FX Sends - FX1 and FX2 sends for each pad

Map MIDI CC Numbers to razzmatazz Settings with MIDI Learn

Each MIDI CC can be used to control one setting on the razzmatazz. Each time you learn the same CC, the newest mapping will replace any previous mappings. You can also only learn one CC per razzmatazz setting. The Macro Control mappings are learned specifically for the currently selected pad. To map a MIDI CC to a razzmatazz setting:

1. Push Right Arrow from the Pads Home screen to open the Nanobox Configuration screen.
2. Set MIDI Learn to On. A blue dot appears in the header to show that MIDI Learn is enabled.
3. Navigate to the setting you want to map on the razzmatazz. Settings that can be mapped will have a blue frame around them.
4. Touch to select the specific setting you want to control. The selected control will turn a lighter blue.
5. Move the MIDI controller you want to map. The map is now complete.
6. Continue steps 2 through 4 for any additional controls.
7. Turn off MIDI Learn mode on the Nanobox Configuration screen to resume normal operation.

MIDI Mappings are saved with each preset.

MIDI Learn stays on until you turn it off.



**MIDI Learn
Macro Controls**

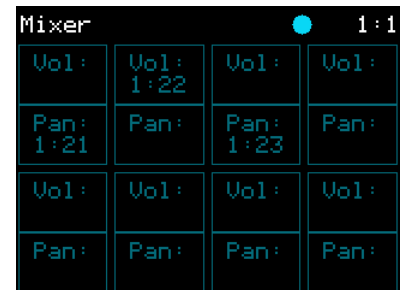

**MIDI Learn
Mixer Settings**

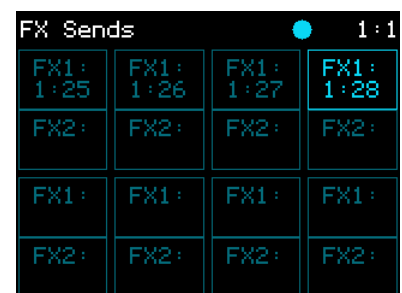

**MIDI Learn
FX Sends**

Clear a MIDI Mapping to a Control

Here's how to remove a mapping of a MIDI CC to a razzmatazz setting:

1. Push Right Arrow from the Pads Home screen to open the Nanobox Configuration screen.
2. Set MIDI Learn to On. A blue dot appears in the header to show that MIDI Learn is enabled.
3. Navigate to the setting you want to stop controlling via a MIDI CC. Mapped controls display the MIDI Channel and MIDI CC number on them.
4. Touch and hold the control until the MIDI Channel and MIDI CC number are no longer displayed on the control.
5. Turn off MIDI learn mode on the Nanobox Configuration screen to resume normal operation.

Map a MIDI Note to a control using MIDI Learn to toggle a setting between the maximum and minimum values.

MIDI PROGRAM CHANGE: LOAD NEW KIT PRESETS

You can configure the razzmatazz to respond to MIDI Program Changes by swapping presets. You will need to enable this option on the [Nanobox Configuration](#) screen, as described above. Once enabled, the presets are mapped to program changes in alphabetical order. The first preset in alphabetical order will be mapped to the lowest MIDI Program Change number for your MIDI Controller. If you want a specific mapping, we recommend you rename the presets to match your needs.

MIDI ALL NOTES OFF: CLEAR STUCK NOTES

In rare occasions, the razzmatazz may not receive the Note Off signal from a MIDI controller, and the note will continue playing endlessly. If you have a stuck note, try the following:

- Open the Transports screen (touch the clock) and push Stop once or twice.
- Hold down the Layer button to stop all audio playback and end all event triggers in the queue.

SYNCHRONIZE WITH AN EXTERNAL CLOCK

You can use an analog clock pulse to synchronize the razzmatazz with other gear. You can tell the razzmatazz how many pulses per quarter (PPQs) are in the clock signal by choosing an option for the Clock Input setting on the [Nanobox Config](#) screen. Connect the clock pulse signal to the Clock In jack on the back of the razzmatazz.

The razzmatazz will follow the first clock available from the following list:

1. Clock In
2. MIDI Clock
3. Internal BPM from the Transports pop-up..

USE MODULATION TO VARY SETTINGS

You can add more dynamics to the sound by applying internal and external modulation to the pad settings.

Any parameter in a settings list that has three squares along the right side is a modulation target, such as the Hold and Decay fields shown on the right. If a modulation slot is violet, that modulation slot is in use.

1. Navigate to the setting you want to modulate.
2. Push the Right Arrow button while the modulation target is selected.
3. Select a Source for a modulation slot. The table below lists the sources that are available.
4. Set a value for the amount below the source. The amount controls the level of impact that source will have on this parameter. A source with an amount of 0.0 will have no impact on the parameter.
5. Push Left Arrow to close the Modulation Settings screen.

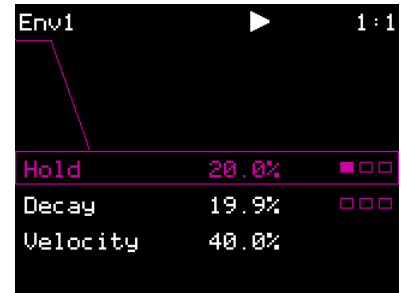

Env1 with Modulation of Hold

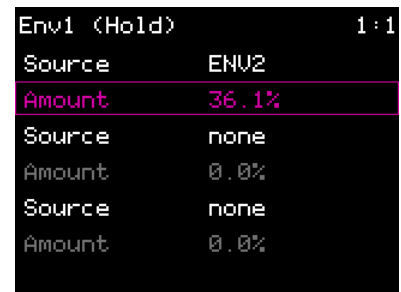

Modulation Settings for Env1 Hold

Source	Type
Env1	Internal
Env2	Internal
LFO	Internal
Velocity	MIDI or Super Stepper
Pressure	MIDI
Mod Wheel	MIDI

WORK WITH THE MICRO SD CARD

The razzmatazz stores all of its data on the microSD card. The table below lists the files used by the device.

There are different types of adapters available to allow you to use your microSD card with the SD Card slot and USB input on your computer. With any of these adapters, you will need to **choose the option to eject the card before you pull the adapter out of the computer in order to avoid corrupting the card.**

If you need to format a new microSD card, we recommend the tool provided by the SD Association. You can find it at <https://www.sdcard.org/downloads/formatter/>.

You can use the microSD card on your computer to back up your files, share files with others, update the firmware, or add new WAV files to your razzmatazz.

File	File Location	Description
*.nnr	The root of the microSD card	nanobox razzmatazz Kit Preset File
nanobox-razzmatazz.xml	The root of the microSD card	nanobox razzmatazz global settings
*.WAV	\Drums, \Recording, other folders you create	Audio sample files
*.ndm	\Pads and its sub folders	Pad Preset files

BACK UP YOUR FILES

We recommend that you make regular backups of the files on your microSD card to avoid losing your musical creations. If you haven't worked with SD or microSD cards before, you should be aware that you cannot just pull the card out of our computer when you are done working with it. If you do this, you run the risk of corrupting the card. You should choose the option to Eject the drive on your computer.

Once you have connected your microSD card to your computer, you will use standard file management tools to copy the files onto your computer. See the table above for a list of files used by the razzmatazz.

MANAGE WAV FILES

You can use the microSD card with your computer to manage the WAV files on the card. You can load new WAV files onto the card or backup your existing WAV files for safekeeping. The razzmatazz supports samples that meet the following criteria:

- Uses the WAV file format.
- Has 1 or 2 channels.
- Uses 16, 24, or 32 bit resolution.
- 48kHz is the native sample rate and will minimize load on the microprocessor. However any sample rate may be used.
- WAV file names may use alpha numeric characters (A-Z, 0-9) and some special characters. The following characters are NOT allowed:
 - “/\?*>:|
- File names must be less than 256 characters, including the path name.

You can use a microSD Adapter to insert your microSD card into your computer. Then you may use standard file techniques to rename the WAV files, reorganize them into directories, delete them, copy them onto your computer, or copy them onto other microSD cards. Be careful with moving and renaming .WAV files, because any presets that use those files will no longer be able to find them.

When you record a new .wav file on razzmatazz, it will be stored in the \Recording folder on the microSD card. The first new recording will be saved as \Recording\RC000001.wav. The number in the file name will be incremented with each additional recording.

When you load a WAV file into a pad, the preset will have a pointer to that WAV file in its source folder. If you move or rename that file, the link to the preset will be lost.

Files that do not meet the naming rules will not be recognized by razzmatazz.

Before you remove a microSD card from a computer, you must select the option to Eject the card in order to avoid corrupting your card.

SHARE PADS & PRESETS

You can share your presets and pads with others, or move them to another microSD by moving the related files.

To share a Kit Preset, find the .nnr file in the root folder on the microSD card with the same name as the preset. You will also need to find all WAV files used by the preset. Copy the .nnr file and the .wav files to the same folders on the destination card in order to ensure razzmatazz can find everything it needs. Not all presets use .WAV files.

To share a Pad Preset, find the .ndm file in the \Drums folder or one of the sub folders, along with the .wav file, if any, used by the pad. You can move the .ndm file to any folder under the \Drums folder, but the .wav file must be in the same file folder as on the source microSD.

Once the files are on the microSD card, the razzmatazz will be able to use them.

UPDATE FIRMWARE

We strongly recommend that you check the 1010music forum, <https://forum.1010music.com>, for the latest firmware release. New releases may contain bug fixes and new features. Updating is easy:

1. Download the NANORAZZ.BIN file from the forum. You must register for the forum (for free) to get access to the downloads area.

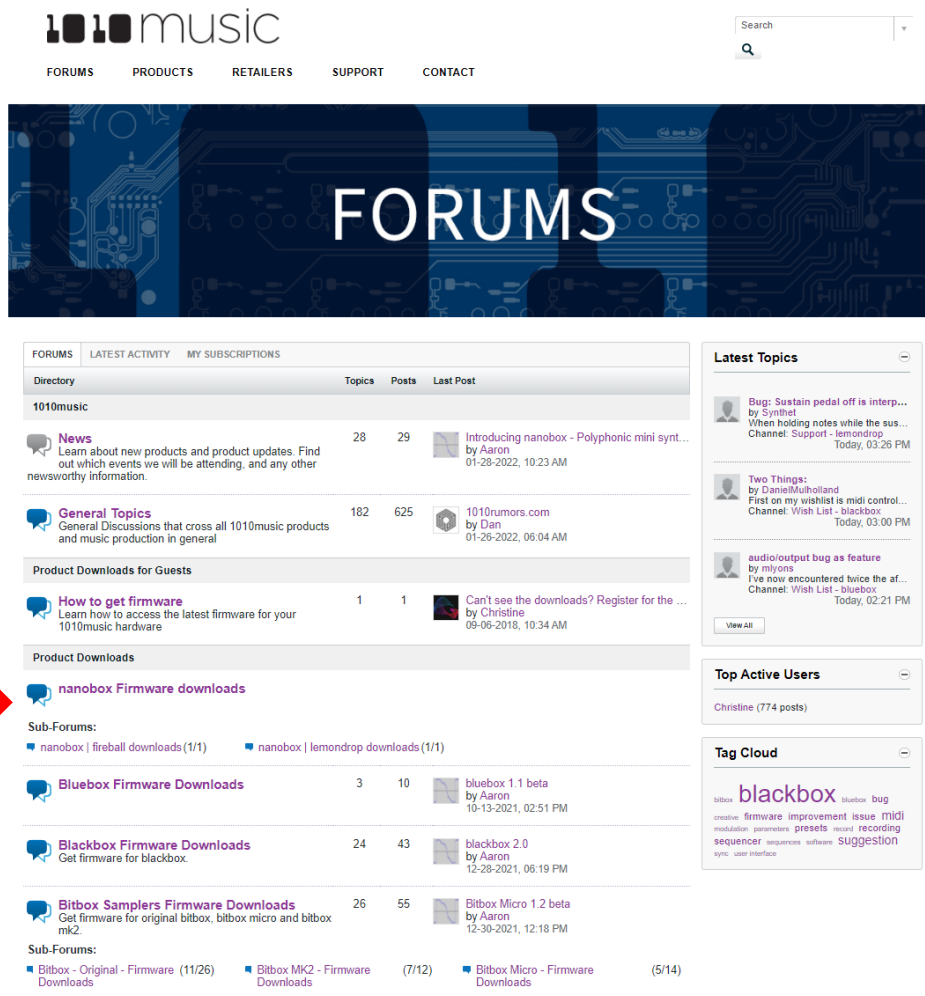

2. Replace the NANORAZZ.BIN file on the microSD card with the downloaded file. Note that the filename must be exactly NANORAZZ.BIN.
3. Replace the microSD card in nanobox and then unplug the razzmatazz and plug it back in. The razzmatazz will automatically load the firmware from the microSD card. The current version is displayed on the splash screen and on the Nanobox Configuration screen.