

Stereo Prismatic Oscillator (XPO)



MAKE NOISE

XPO

3	Limited Warranty
4	Installation
5	Introduction
6	Panel Controls and Inputs/Outputs
9	Waveform Outputs
12	Frequency Controls
14	Timbre Controls
15	Tips and Tricks
16	Patch Corner

Make Noise warrants this product to be free of defects in materials or construction for a period of one year from the date of purchase (proof of purchase/invoice required).

Malfunction resulting from wrong power supply voltages, backwards or reversed eurorack bus board cable connection, abuse of the product, removing knobs, changing face plates, or any other causes determined by Make Noise to be the fault of the user are not covered by this warranty, and normal service rates will apply.

During the warranty period, any defective products will be repaired or replaced, at the option of Make Noise, on a return-to-Make Noise basis with the customer paying the transit cost to Make Noise.

Make Noise implies and accepts no responsibility for harm to person or apparatus caused through operation of this product.

Please contact technical@makenoisemusic.com with any questions, Return To Manufacturer Authorization, or any needs & comments.

<http://www.makenoisemusic.com>



About This Manual:

Written by Walker Farrell and Tony Rolando
Illustrated by Walker Farrell and Lewis Dahm

XPO Hardware Design: Tony Rolando

Special Thanks to the Beta Testers!

Electrocution hazard!

Always turn the Eurorack case off and unplug the power cord before plugging or unplugging any Eurorack bus board connection cable. **Do not touch any electrical terminals when attaching any Eurorack bus board cable.**

The Make Noise soundhack XPO is an electronic music module requiring 140mA of +12VDC and 132mA of -12VDC regulated voltage and a properly formatted distribution receptacle to operate. It is designed to be used within the Eurorack format modular synthesizer system.

Go to <http://www.makenoisemusic.com/> for examples of Eurorack Systems and Cases.

To install, find 18hp of space in your Eurorack synthesizer case, confirm proper installation of included eurorack bus board connector cable on backside of module (see picture below), plug the bus board connector cable into the Eurorack style bus board, minding the polarity so that the RED stripe on the cable is oriented to the NEGATIVE 12 Volt line on both the module and the bus board. On the Make Noise 6U or 3U Busboard, the NEGATIVE 12 Volt line is indicated by the white stripe.



-12V

Please refer to your case manufacturers' specifications for location of the Negative supply.

The XPO or Stereo Prismatic Oscillator is a Voltage Controlled Analog Oscillator designed for Stereo Timbre Modulations (including Pulse Width Modulation and Wavefolding), Oscillator SYNC, Linear FM and more in the analog domain. It also generates monaural Sine waves, Triangle waves, Sawtooth and Spike waves, and Sub-Octaves.

The XPO is designed as the Stereo VCO complement to our Stereo Quad core VCF QPAS, as is the core idea of complex circuits being controlled in multiple dimensions in the stereo field by a few powerful parameters. The Stereo Prismatic Oscillator also makes a particularly useful patch buddy for the STO, Mimeophon, and X-PAN.

The XPO yields harmonically rich textures through the use of Sync, Linear and Exponential FM, and especially several unique forms of complex multi-dimensional Stereo waveshaping via the Modulate Left, Modulate Right, and Center parameters. All outputs are available simultaneously, and all analog controls on the XPO are paired with control voltage inputs for full integration into a modular synthesizer.

The XPO uses a Triangle Core and along the top you find individual Mono outputs for Sine, Triangle, Sawtooth, Spike, and Sub-Oscillator. Along the right side there are three pairs of outputs for Stereo Pulse-Width Modulation (PWM), Stereo Vari-Timbre, and Stereo Wavefolding. The stereo outputs are controlled by two "Modulate" parameters for their Left and Right outputs. Additionally the Vari-Timbre and Wavefolding outputs have a third timbre parameter called Center that modulates left and right sides simultaneously another unique way.

The XPO has two identical 1v/oct inputs, a Sync input, an Exponential FM input with attenuverter, and a Linear FM input with a Depth control and CV, as well as a normalization of the Sub oscillator waveform to the Linear FM input for easy "growl."

The XPO is a 100% analog musical instrument that is not suitable for laboratory use.

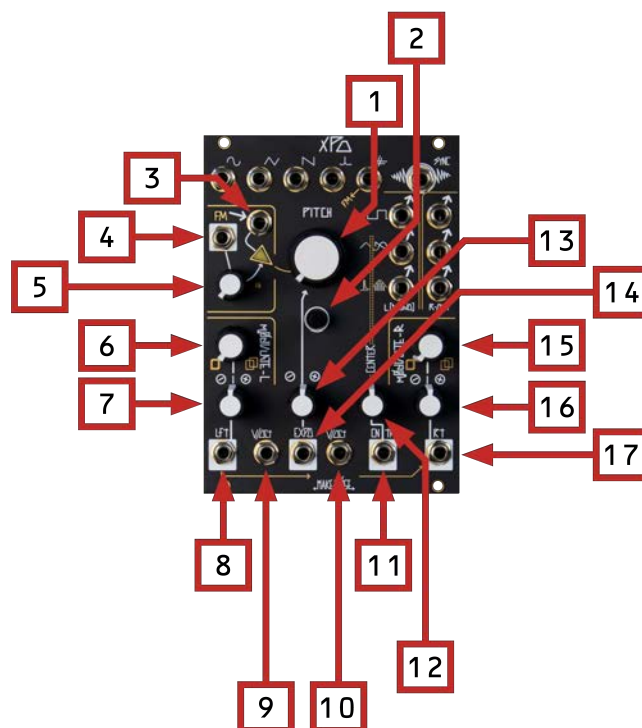

XPO Panel Controls and Inputs/Outputs

1. **Pitch control.** Sets core frequency of the XPO.
2. **Fine tune.** Fine control of core frequency for tuning to other VCOs or instruments.
3. **FM Input.** Linear FM Input. AC Coupled. Normaled to Sub Output.
4. **FM Depth CV Input.** CV Input for FM Depth.
5. **FM Depth Combo Pot.** With nothing patched to FM Depth CV Input, sets FM Depth. With Signal patched to FM Depth CV input, works as attenuator for that parameter.
6. **Modulate-L Panel Control.** Modulates Left Stereo outputs' timbre.
7. **Modulate-L CV Input attenuverter.** Bipolar input attenuverter for Modulate-L CV Input
8. **Modulate-L CV Input.** CV Input for Modulate-L. Also controls Modulate-R when Modulate-R CV Input is unpatched.
9. **V/Oct input (1).** Sets core frequency of the XPO via external control, tracks one volt per octave. Summed with Pitch control and V/Oct input (2).
10. **V/Oct input (2).** Sets core frequency of the XPO via external control, tracks one volt per octave. Summed with Pitch control and V/Oct input (1).
11. **Center CV Input.** CV input for Center.
12. **Center Combo Pot.** With nothing patched to Center CV Input, sets Center parameter. With Signal patched to Center input, works as attenuator for that parameter.
13. **Expo FM Input attenuverter.** Bipolar input attenuverter for Expo FM Input
14. **Expo FM Input.** Exponential FM input.
15. **Modulate-R Panel Control.** Modulates Right Stereo outputs' timbre.

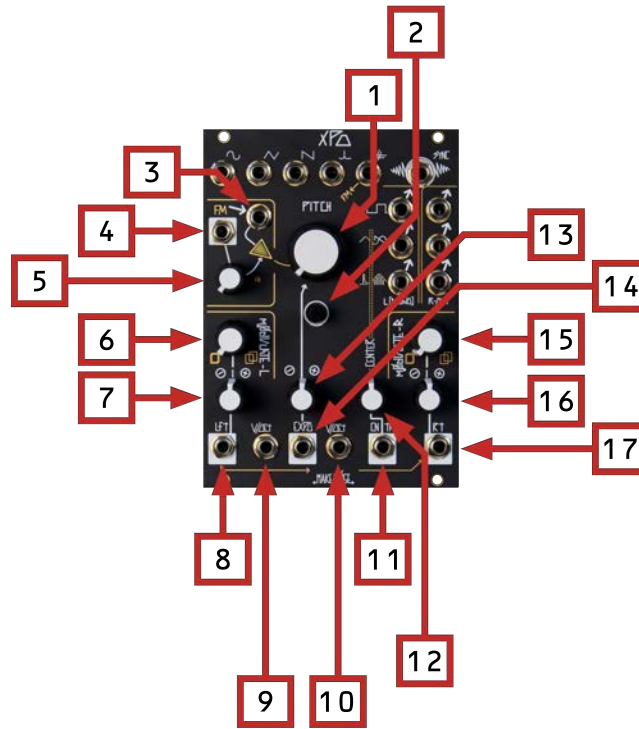

XPO Panel Controls and Inputs/Outputs (Cont.)

16. Modulate-R CV Input attenuverter. Bipolar input attenuverter for Modulate-R CV Input.

17. Modulate-R CV Input. CV Input for Modulate-R. Normaled to Modulate-L CV Input.

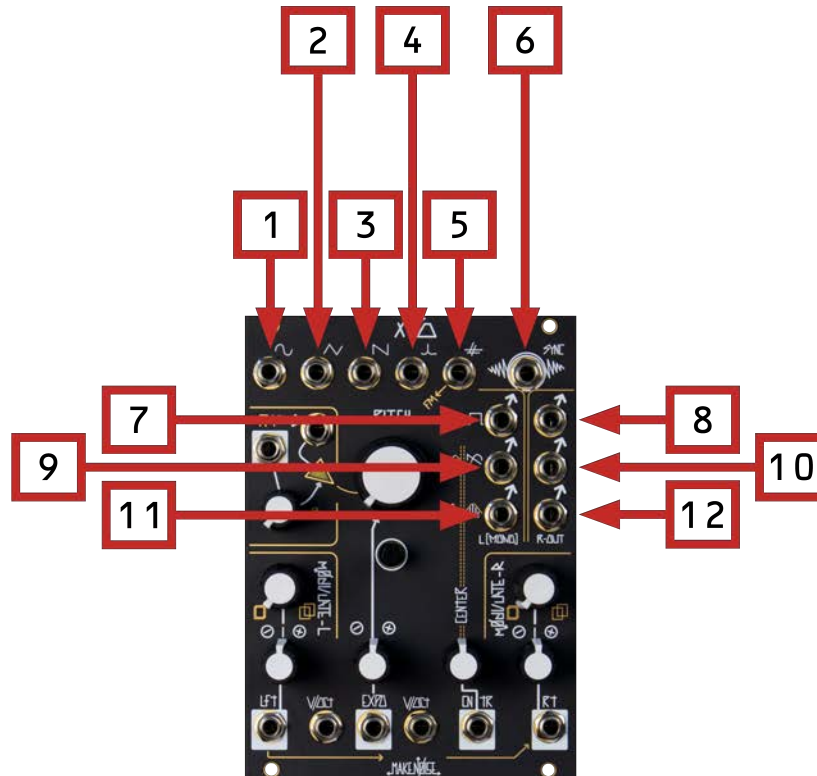

XPO Panel Controls and Inputs/Outputs (cont.)



1. **Sine output.** ~10V peak to peak.
2. **Triangle Output.** ~10V peak to peak.
3. **Sawtooth Output.** ~9V peak to peak.
4. **Spike Output.** ~12V peak to peak.
5. **Sub Output.** ~12V peak to peak.
6. **Sync Input.** Expects audio rate modular synth waveform.
7. **Pulse Width Modulation Left (Mono) output.** 8-12 V peak to peak, amplitude varies based on Modulate controls.
8. **Pulse Width Modulation Right output.** 8-12 V peak to peak, amplitude varies based on Modulate controls.
9. **Vari-Timbre Left (Mono) output.** 8-12V peak to peak, amplitude varies based on Center and Modulate controls.
10. **Vari-Timbre Right output.** 8-12V peak to peak, amplitude varies based on Center and Modulate controls.
11. **Wavefolding Left (Mono) output.** 8-12V peak to peak, amplitude varies based on Center and Modulate controls.
12. **Wavefolding Right output.** 8-12V peak to peak, amplitude varies based on Center and Modulate controls.



Mono Outputs



Along the top of the XPO are five Mono wave shape outputs that are derived from the oscillator core.







The Sine wave is shaped from the Triangle using the same circuit used on the DPO and STO. The Sawtooth, Spike, and Sub outputs are new for XPO. These outputs are useful on their own as traditional VCO outputs to be processed via VCAs, filters etc. Using mixers such as Optomix or X-PAN they could be mixed together and/or panned alongside your choice of stereo outputs, and they can also be very useful as modulation sources for timbral controls on the XPO itself (Center, Modulate, etc.) or for audio rate modulation on processors such as QPAS, especially when said processors are also operating on outputs from the XPO itself, which will always represent at the same frequency at every output.

- 

The **Sine** Wave is derived from the Triangle core of the oscillator and is provided as an output because it is great for blending with signals of greater harmonic content in order to strengthen the fundamental. The Sine shape has almost no harmonics, so it is also a good starting point for creating complex FM sounds because the sidebands introduced through FM are not obscured by harmonics present in the signals utilized.
- 

The **Triangle** Wave is the core shape of the oscillator. It contains slightly more harmonic content than the sine wave and also a strong fundamental, and will cut through a mix slightly more than a sine wave. It can be a useful modulation source where you want more harmonics created, for example audio rate modulation of Filter Cutoff.
- 

The **Sawtooth** Wave is a classic bold East Coast synthesis waveform that is frequently utilized in subtractive synthesis, as it contains all harmonics and provides a rich source for being shaped with filters.
- 

The **Spike** Wave is a thin, tall spike shape with low fundamental presence resulting in a thin, "buzzy" sound. This less common waveform can be found in the seminal West Coast "Music Easel" synthesizer. It is useful for adding or subtracting a strong harmonic from a less harmonic waveform such as triangle. It is also a useful shape for modulation especially destinations that have the potential for "ringing" such as resonant Filters.
- 

Sub Oscillators are a classic Far East Coast waveform that have been used to thicken up the sound when mixed with other waves from the same VCO. The **Sub** Waveform output on the XPO contains a mix of multiple Square waves derived from the oscillator core at lower octaves (sub-harmonics). This output is a good candidate for subtractive synthesis with filters. It is great for basslines and other "fat" sounds, but it is also an excellent Modulation source. Patched to the Filter Cutoff of QPAS it will super-impose sub-harmonics that make the filter growl.

Another version of the Sub Wave is also normalized to the XPO's Linear FM input. With nothing patched to this input, FM Depth can be used as an additional voltage controlled timbre parameter with the result being sub harmonic FM.

Stereo Outputs

Along the right side of the XPO are three pairs of Stereo outputs that are derived from the oscillator core. These outputs provide great audio sources for stereo processing modules such as QPAS or Mimeophon. All three output pairs receive timbral modulation from the Modulate L/R parameters, and can be used in Mono via their Left output when the Right is unpatched. Additionally the Vari-Timbre and Wave Folding outputs receive timbral modulation from the Center parameter on both outputs at once.

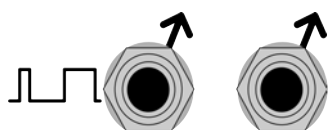
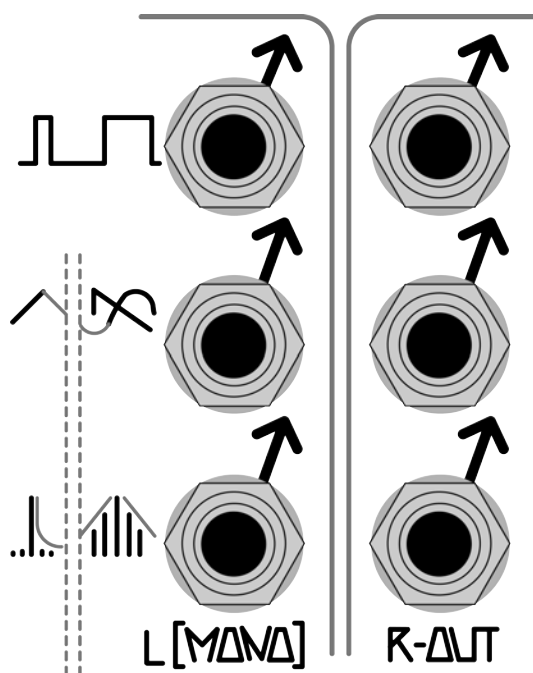

The **Pulse Width Modulation** outputs utilize a classic PWM circuit to modulate the width of a pulse wave continuously from 0% (silence) at full CCW on the Modulate controls, to 50% (square wave) around 12:00, to ~99% (a very thin pulse) at full CW. Using control voltage, the pulse-width can be increased all the way to 100% (silence again).

Pulse width modulation tends to create alternate sets of even and odd harmonics. Since the XPO offers two independent PWM parameters on the two outputs, interesting combinations can be heard when monitoring in stereo and modulating both sides simultaneously at the same or different rates and amounts.

The Left and Right PWM outputs are controlled independently by the Modulate controls. When the Right output is unpatched, the Left output contains a sum of the Left output and an inverted copy of the Right output. Using just the Left output in this case for a Mono signal allows for interesting phasing behaviors when modulating one or both waves.

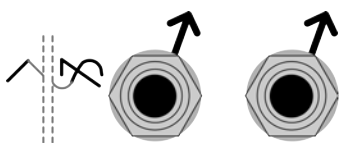

Vari-Timbre is derived from the Sine, Triangle, and Sawtooth waveforms. The Center parameter cross-fades both left and right Vari-Timbre signals from Sine to Sawtooth, a function found in classic WEST COAST synthesizer circuits such as the Buchla 158 and 258.

This is useful in a way that is similar to a Low Pass filter, where the sound can transform from smooth and soft, to more biting and bright. The resulting Sine/ Saw shape is then further processed with the Modulate L/R parameters cutting the Triangle wave into the waveform determined by Center parameter (Sine/ Saw). From 0% at full CCW, to 50% at about 12:00, to 99% at full CW. Using control voltage, the triangle's presence can be increased all the way to 100%.

The Left and Right Variable outputs are controlled independently by the Modulate controls. The Center parameter operates identically on both outputs.

When the Right output is unpatched, the Left output contains a sum of the Left output and an inverted copy of the Right output. Using just the Left output in this case for a Mono signal allows for interesting phasing behaviors when modulating one or both waves. The Center parameter tends to be more subtle in Mono since there is much opportunity for phase cancellation through the center of the resulting waveform, but may still provide increased harmonics when modulated at audio rate. It is this MONO functionality that allows Make Noise to create the elusive Bat waveform.

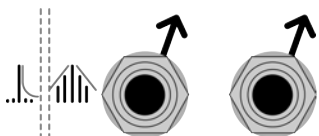

The **Wavefolding** outputs utilize wavefolding circuits similar to the Final output on the DPO and the Multiply circuit on 0-Coast.

With Modulate full CCW, the wavefolder gain is low enough that the output will be functionally silent. As Modulate L/R increases, a wave will appear and then fold over on itself. The number of folds increase from zero to five through the range of the Modulate L/R parameters. The Center parameter modulates the shape and fold point of the wave sent through the wavefolder, with the simplest saturated sinusoid wave appearing at full CCW and a thin crispy series of Spikes occurring Full CW.

The Left and Right Folded outputs are controlled independently by the Modulate controls. The Center parameter operates identically on both outputs.

When the Right Folded output is unpatched, the Left output contains a combination of the Left and Right wavefolding circuits. Using just the Left output in this case for a Mono signal allows for interesting phasing behaviors when modulating one or both waves.

Frequency Controls

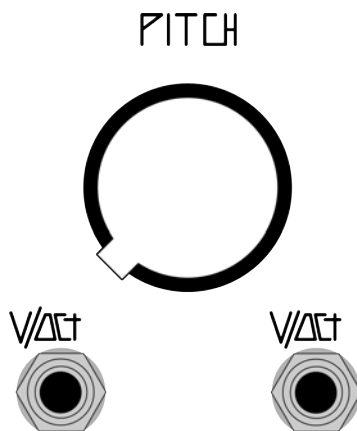

The **1v/oct inputs** are for sequencing or controlling the XPO's pitch via sequencer, keyboard etc. They are factory calibrated to track one volt per octave and are ideal for sequencing with 1v/oct quantized sources such as René, or analog unquantized sources such as 0-CTRL. The two 1v/oct inputs are summed with the large Pitch knob and the FM inputs to determine the oscillator frequency at any given moment. The second 1v/oct input can be useful for transposition or as an additional Exponential FM input.



The **Exponential FM input** can be used for vibrato, audio rate FM, Pitch Envelopes, or Sync Sweeps, and is outfitted with an attenuverter for depth and polarity control.

Frequency Controls (cont.)

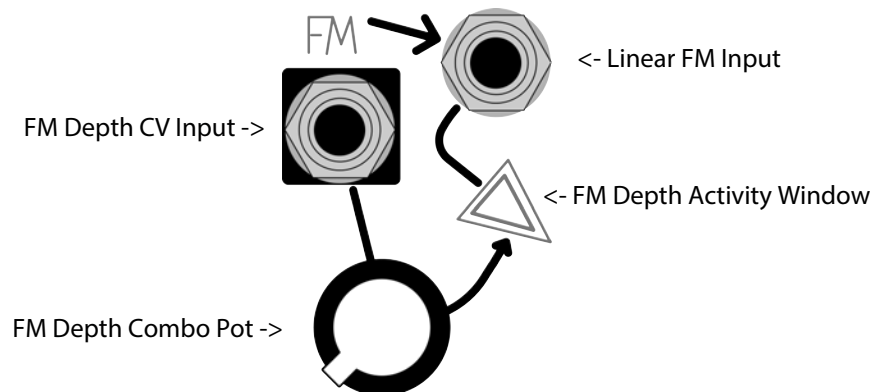

The **Linear FM** input is well suited to audio-rate FM via other VCOs, fast cycling functions from MATHS, or self-patching from the XPO itself. The input is normalised to a version of the Sub Oscillator output, which allows for the superimposition of sub-harmonics without the need to mix in the Sub-Oscillator with the other waveform outputs.

FM Depth sets the amount of Linear FM. It can be voltage controlled via the CV input. Dynamic FM is useful for creating dynamic harmonic profiles with voltage control, sounds that go from overly rich in harmonics to simple and void of harmonics. The input attenuator is a combo pot - it acts as a panel control, and becomes an attenuator for incoming CV when patched. Current FM Depth is indicated in Red via the FM Depth Activity Window. Keep in mind that when the Linear FM input is unpatched the FM Depth control is still active, controlling the amount of FM from the XPO's Sub Oscillator.

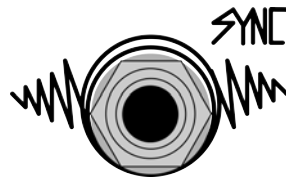

The XPO features a unique Sync circuit. The XPO will attempt to match the frequency of the incoming signal at the Sync input. In practice this makes all Pitch/frequency controls of the XPO into timbre controls as well. This sync circuit could be described as something like a "medium sync." The window for acceptable oscillator resets is wider than that of soft sync (which barely resets) and hard sync (which always resets). The result is a rippling effect as the sync source's pitch is swept. You may hear "peaks" of hard sync and "valleys" of missing resets in the outputs of the XPO.

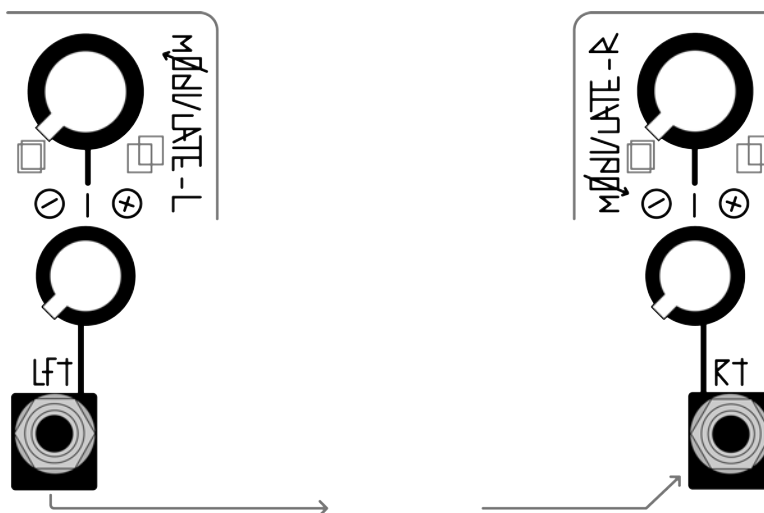

The three stereo output pairs (PWM, Vari-Timbre, Wavefolding) are each affected by the **Modulate L/R** controls in a unique way (see **Stereo Outputs** above for more information).

For all stereo pairs, Modulate L affects only the Left output, while Modulate R affects only the Right output. When using only the Left output jack, both outputs are mixed together for a Mono version and will be affected by both Left and Right Modulate controls.

Each Modulate control has a panel control and attenuverter, and the Modulate L input is normaled to Modulate R, so that a single control voltage source at Modulate-L can be used to modulate both sides, with modulation depth and polarity set per side by their respective panel controls and attenuverters.



The **Center** parameter is a combo pot - it acts as a panel control, and becomes an attenuator for incoming CV when patched. This parameter affects the Vari-Timbre and Wavefolding outputs in various ways.

For the Vari-Timbre outputs, with Modulate counterclockwise, Center causes a crossfade from Sine at full counterclockwise to Sawtooth at full clockwise. The resulting shape is used to “feed” the Vari-Timbre parameter at higher values of Modulate. Note that due to the way the two outputs interact when patched in Mono (Left Vari-Timbre output only), the Center parameter tends to be subtle on Mono Vari-Timbre when modulated at low frequencies. It makes a great source for audio rate modulation, as it does not create pitch bending even at full depth.

For Wavefolding, the Center parameter adjusts the shape and angle of the wave that feeds the Left and Right Wavefolders as the Modulate controls are turned up. The resulting sound tends to become brighter and thinner, or darker and richer, at various points within the Center parameter.

- Use the second 1v/oct input with a keyboard, sequencer or Pressure Points/0-CTRL for manual or sequenced pitch transposition.
 - When using the Wavefolding output in Mono (Left output only, Right output unpatched), the Left side will be weighted slightly heavier in the result than the Right. This weighting lets one set of harmonics be used for accent while the other is the basis of the sound.
 - The PWM and Vari-Timbre Mono outputs feature a normalization of an inverted copy of their Right output. This means that when used in Mono (Left output only, Right output unpatched), the Modulate L/R controls will create more "peaks and valleys" in the outputs due to various phase cancellation possibilities. In general the mono PWM output is more punchy/aggressive than its stereo counterpart, while the mono Vari-Timbre output is more gentle (this is not a hard fast rule!)
 - Any unused waveform output can make a great modulation source for filters such as QPAS, other modules in the patch, or the XPO itself. For example, the Spike wave makes a great frequency modulator for a low pass filter, adding a subtle high frequency sheen back on to sounds that have had their edges shaved off. When the XPO is also the sound source, modulations patched in this way will be "in tune" 100% of the time.
 - Because Center modulation does not affect the Mono outputs or the PWM Stereo Outs, it can be used to subtly or drastically change the Vari-Timbre or Wavefolding outputs while mixing with other outputs that stay unmodulated. Similarly, the Mono outputs are not affected at all by Modulate or Center controls, and can be used as an "anchor" when mixed in with any of the stereo outputs.
 - After removing your patch cable from the FM Depth CV Input, don't forget to turn the Combo Pot back down to remove the Sub FM Normalization ... unless you want to!
 - Use the center parameter for audio rate modulation to create harmonics while the Modulate L/R parameters provide animation of those harmonics.
-

"Computer Vision" by Jake Pugh

Use faster LFO rates for trance effect.

Bonus for ch. 1 of maths: mult sequence to both input for note tracking pwm rate.

Offset radiates for best stereo results and modulate at will.

Try long, tempo synced delays. use filtering and note changes from sequence for dynamics. adjust pwm rate and intensity to taste. try adjusting ch.4 of maths for longer notes or different flavors. the more emotional the sequence the better.

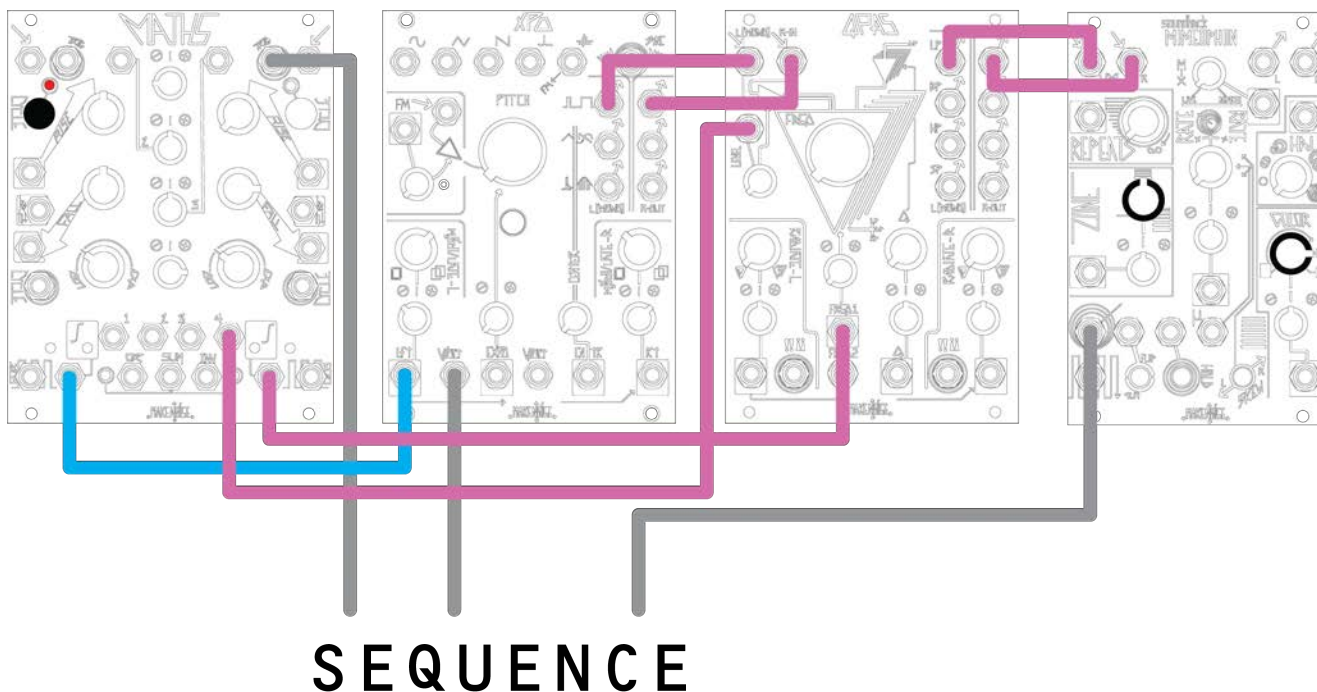

"This Car Is About To Go Pretty Fast" by Newt Pal

In this current state, the car is idling, getting ready to go pretty fast.

When you are ready, you can turn up FM on the XPO to begin the process of going pretty fast.

You can continue to accelerate via XPO pitch knob.

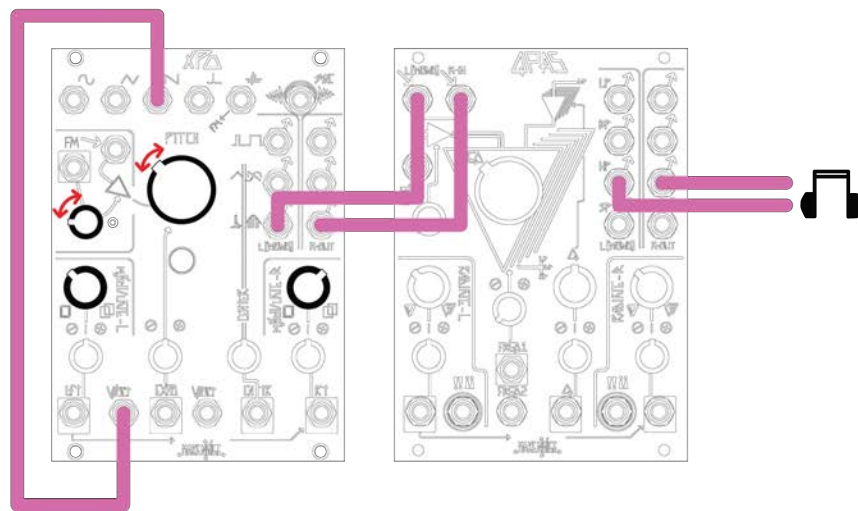

"Talking Patch" by Peter Speer

Pitch should be played manually and in a conversational manner. Starting around 10:00 and sweeping chaotically to around 2:00 works well.

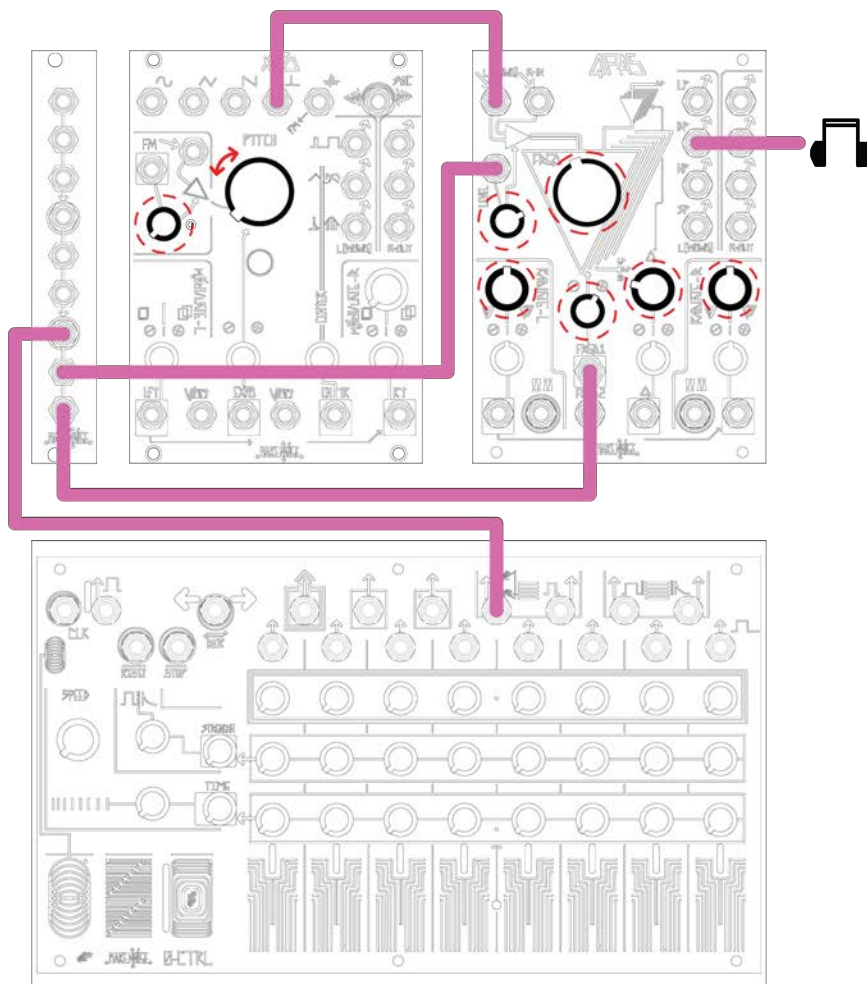

"Stereo Canopy" by Ryan Jobes

Adjust FM and Modulation L/R to taste.

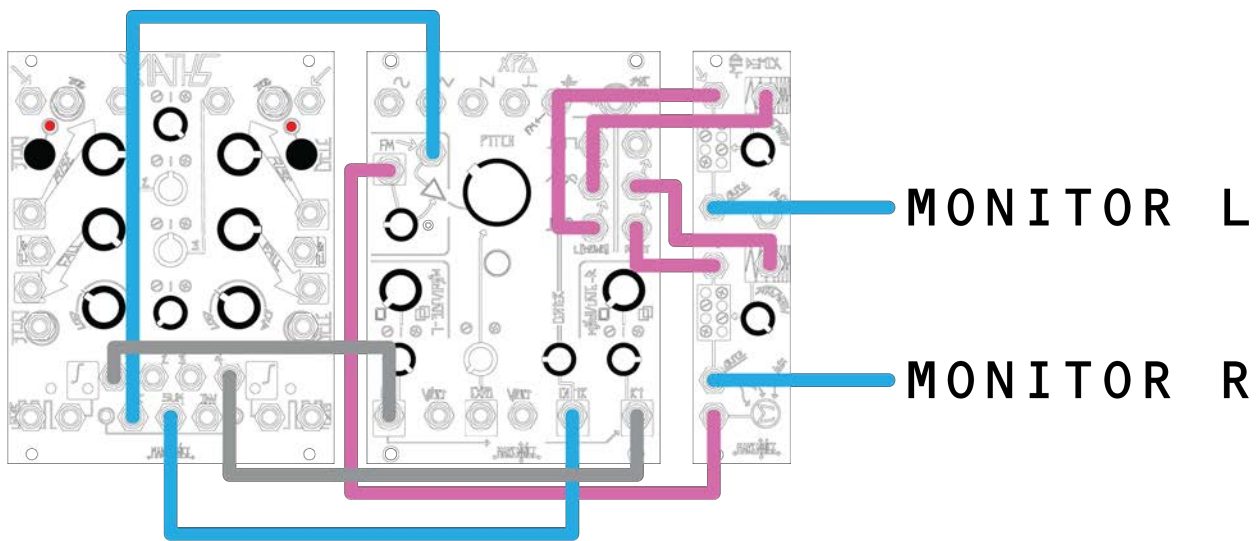

"Dial-Up Motor" by Sam Turner

A feedback patch that results in chugging pulses, beeps, and noise reminiscent of a dial-up modem chasing its own tail. Use the Pitch, Cntr, and Modulate-R attenuverter pots to explore a wide array of sounds and rhythms.

