

DIGITAL KEYBOARD  
**PSS-E30**

- Owner's Manual
- Before using the instrument, be sure to read "PRECAUTIONS" on pages 4-5.

# SPECIAL MESSAGE SECTION

This product utilizes batteries or an external power supply (adapter). DO NOT connect this product to any power supply or adapter other than one described in the manual, on the name plate, or specifically recommended by Yamaha.

**WARNING:** Do not place this product in a position where anyone could walk on, trip over, or roll anything over power or connecting cords of any kind. The use of an extension cord is not recommended! If you must use an extension cord, the minimum wire size for a 25' cord (or less) is 18 AWG. NOTE: The smaller the AWG number, the larger the current handling capacity. For longer extension cords, consult a local electrician.

This product should be used only with the components supplied or; a cart, rack, or stand that is recommended by Yamaha. If a cart, etc., is used, please observe all safety markings and instructions that accompany the accessory product.

## **SPECIFICATIONS SUBJECT TO CHANGE:**

The information contained in this manual is believed to be correct at the time of printing. However, Yamaha reserves the right to change or modify any of the specifications without notice or obligation to update existing units.

This product, either alone or in combination with an amplifier and headphones or speaker/s, may be capable of producing sound levels that could cause permanent hearing loss. DO NOT operate for long periods of time at a high volume level or at a level that is uncomfortable. If you experience any hearing loss or ringing in the ears, you should consult an audiologist. IMPORTANT: The louder the sound, the shorter the time period before damage occurs.

Some Yamaha products may have benches and / or accessory mounting fixtures that are either supplied with the product or as optional accessories. Some of these items are designed to be dealer assembled or installed. Please make sure that benches are stable and any optional fixtures (where applicable) are well secured BEFORE using.

Benches supplied by Yamaha are designed for seating only. No other uses are recommended.

## **NOTICE:**

Service charges incurred due to a lack of knowledge relating to how a function or effect works (when the unit is operating as designed) are not covered by the manufacturer's warranty, and are therefore the owners responsibility. Please study this manual carefully and consult your dealer before requesting service.

## **ENVIRONMENTAL ISSUES:**

Yamaha strives to produce products that are both user safe and environmentally friendly. We sincerely believe that our products and the production methods used to produce them, meet these goals. In keeping with both the letter and the spirit of the law, we want you to be aware of the following:

## **Battery Notice:**

This product MAY contain a small non-rechargeable battery which (if applicable) is soldered in place. The average life span of this type of battery is approximately five years. When replacement becomes necessary, contact a qualified service representative to perform the replacement.

This product may also use "household" type batteries. Some of these may be rechargeable. Make sure that the battery being charged is a rechargeable type and that the charger is intended for the battery being charged.

When installing batteries, never mix old batteries with new ones, and never mix different types of batteries. Batteries MUST be installed correctly. Mismatches or incorrect installation may result in overheating and battery case rupture.

## **Warning:**

Do not attempt to disassemble, or incinerate any battery. Keep all batteries away from children. Dispose of used batteries promptly and as regulated by the laws in your area. Note: Check with any retailer of household type batteries in your area for battery disposal information.

## **Disposal Notice:**

Should this product become damaged beyond repair, or for some reason its useful life is considered to be at an end, please observe all local, state, and federal regulations that relate to the disposal of products that contain lead, batteries, plastics, etc. If your dealer is unable to assist you, please contact Yamaha directly.

## **NAME PLATE LOCATION:**

The name plate is located on the bottom of the product. The model number, serial number, power requirements, etc., are located on this plate. You should record the model number, serial number, and the date of purchase in the spaces provided below and retain this manual as a permanent record of your purchase.

**Model**

---

**Serial No.**

---

**Purchase Date**

---

# PLEASE KEEP THIS MANUAL

92-BP (bottom)

## FCC INFORMATION (U.S.A.)

### 1. IMPORTANT NOTICE: DO NOT MODIFY THIS UNIT!

This product, when installed as indicated in the instructions contained in this manual, meets FCC requirements. Modifications not expressly approved by Yamaha may void your authority, granted by the FCC, to use the product.

**2. IMPORTANT:** When connecting this product to accessories and/or another product use only high quality shielded cables. Cable/s supplied with this product **MUST** be used. Follow all installation instructions. Failure to follow instructions could void your FCC authorization to use this product in the USA.

**3. NOTE:** This product has been tested and found to comply with the requirements listed in FCC Regulations, Part 15 for Class "B" digital devices. Compliance with these requirements provides a reasonable level of assurance that your use of this product in a residential environment will not result in harmful interference with other electronic devices. This equipment generates/uses radio frequencies and, if not installed and used according to the instructions found in the users manual, may cause interference harmful to the operation of other electronic

devices. Compliance with FCC regulations does not guarantee that interference will not occur in all installations. If this product is found to be the source of interference, which can be determined by turning the unit "OFF" and "ON", please try to eliminate the problem by using one of the following measures:  
Relocate either this product or the device that is being affected by the interference.

Utilize power outlets that are on different branch (circuit breaker or fuse) circuits or install AC line filter/s.

In the case of radio or TV interference, relocate/reorient the antenna. If the antenna lead-in is 300 ohm ribbon lead, change the lead-in to co-axial type cable.

If these corrective measures do not produce satisfactory results, please contact the local retailer authorized to distribute this type of product. If you can not locate the appropriate retailer, please contact Yamaha Corporation of America, Electronic Service Division, 6600 Orangethorpe Ave, Buena Park, CA90620

The above statements apply **ONLY** to those products distributed by Yamaha Corporation of America or its subsidiaries.

\* This applies only to products distributed by Yamaha Corporation of America.

(class B)

### COMPLIANCE INFORMATION STATEMENT (Supplier's declaration of conformity procedure)

Responsible Party : Yamaha Corporation of America  
Address : 6600 Orangethorpe Ave., Buena Park, Calif. 90620  
Telephone : 714-522-9011  
Type of Equipment : Digital Keyboard  
Model Name : PSS-E30

This device complies with Part 15 of the FCC Rules.

Operation is subject to the following two conditions:

- 1) this device may not cause harmful interference, and
- 2) this device must accept any interference received including interference that may cause undesired operation.

\* This applies only to products distributed by Yamaha Corporation of America.

(FCC SDoC)

The model number, serial number, power requirements, etc., may be found on or near the name plate, which is at the bottom of the unit.

You should note this serial number in the space provided below and retain this manual as a permanent record of your purchase to aid identification in the event of theft.

**Model No.**

---

**Serial No.**

---

(bottom\_en\_01)

# PRECAUTIONS

## PLEASE READ CAREFULLY BEFORE PROCEEDING

Please keep this manual in a safe and handy place for future reference.



## WARNING

**Always follow the basic precautions listed below to avoid the possibility of serious injury or even death from electrical shock, short-circuiting, damages, fire or other hazards. These precautions include, but are not limited to, the following:**

### Power supply

- Do not place the USB cable near heat sources such as heaters or radiators. Also, do not excessively bend or otherwise damage the cable, or place heavy objects on it.
- Only use the voltage specified as correct for the instrument. The required voltage is printed on the name plate of the instrument.
- Included USB cable is designed for use with only this instrument. Do not use for any other instrument.
- Check the plug periodically and remove any dirt or dust which may have accumulated on it.

### Do not open

- This instrument contains no user-serviceable parts. Do not open the instrument or attempt to disassemble or modify the internal components in any way. If it should appear to be malfunctioning, discontinue use immediately and have it inspected by qualified Yamaha service personnel.

### Water warning

- Do not expose the instrument to rain, use it near water or in damp or wet conditions, or place on it any containers (such as vases, bottles or glasses) containing liquids which might spill into any openings. If any liquid such as water seeps into the instrument, turn off the power immediately and disconnect the plug from the AC outlet. Then have the instrument inspected by qualified Yamaha service personnel.
- Never insert or remove a plug with wet hands.

### Fire warning

- Do not put burning items, such as candles, on the unit. A burning item may fall over and cause a fire.

## Influences on electro-medical devices

- Magnetism may affect electro-medical devices.
  - Do not use this product near medical devices or inside areas in which the use of radio waves is restricted.
  - Do not use this product within 15 cm (6 in.) of persons with a heart pacemaker or defibrillator implant.

## Battery

- Follow the precautions below. Failure to do so might result in explosion, fire, overheating or battery fluid leakage.
  - Do not tamper with or disassemble batteries.
  - Do not dispose of batteries in fire.
  - Do not attempt to recharge batteries that are not designed to be charged.
  - Keep the batteries separate from metallic objects such as necklaces, hairpins, coins, and keys.
  - Use the specified battery type (page 13) only.
  - Use new batteries, all of which are the same type, same model, and made by the same manufacturer.
  - Always make sure all batteries are inserted in conformity with the +/- polarity markings.
  - When the batteries run out, or if the instrument is not to be used for a long time, remove the batteries from the instrument.
  - When using Ni-MH batteries, follow the instructions that came with the batteries. Use only the specified charger device when charging.
- Keep batteries away from small children who might accidentally swallow them.
- If the batteries do leak, avoid contact with the leaked fluid. If the battery fluid should come in contact with your eyes, mouth, or skin, wash immediately with water and consult a doctor. Battery fluid is corrosive and may possibly cause loss of sight or chemical burns.

## If you notice any abnormality

- When one of the following problems occur, immediately turn off the power switch and disconnect the plug from the outlet. (If you are using batteries, remove all batteries from the instrument.) Then have the device inspected by Yamaha service personnel.
  - The USB cable or plug becomes frayed or damaged.
  - It emits unusual smells or smoke.
  - Some object has been dropped into the instrument.
  - There is a sudden loss of sound during use of the instrument.
  - If any cracks or breakages exist on the instrument.

# **CAUTION**

**Always follow the basic precautions listed below to avoid the possibility of physical injury to you or others, or damage to the instrument or other property. These precautions include, but are not limited to, the following:**

## **Power supply**

- Use the specified USB power adaptor (page 6) only. Using the wrong adaptor can result in damage to the instrument or overheating.
- Do not connect the instrument to an electrical outlet using a multiple connector. Doing so can result in lower sound quality, or possibly cause overheating in the outlet.
- When removing the plug from the instrument or an outlet, always hold the plug itself and not the USB cable. Pulling by the cable can damage it.
- Remove the plug from the outlet when the instrument is not to be used for extended periods of time, or during electrical storms.

## **Location**

- Do not place the instrument in an unstable position where it might accidentally fall over.
- Before moving the instrument, remove all connected cables, to prevent damage to the cables or injury to anyone who might trip over them.
- When setting up the product, make sure that the AC outlet you are using is easily accessible. If some trouble or malfunction occurs, immediately turn off the power switch and disconnect the plug from the outlet. Even when the power switch is turned off, electricity is still flowing to the product at the minimum level. When you are not using the product for a long time, make sure to disconnect the plug from the wall AC outlet.

## **Connections**

- Before connecting the instrument to other electronic components, turn off the power for all components. Before turning the power on or off for all components, set all volume levels to minimum.
- Be sure to set the volumes of all components at their minimum levels and gradually raise the volume controls while playing the instrument to set the desired listening level.

## **Handling caution**

- Do not insert a finger or hand in any gaps on the instrument.
- Never insert or drop paper, metallic, or other objects into the gaps on the panel or keyboard. This could cause physical injury to you or others, damage to the instrument or other property, or operational failure.
- Do not rest your weight on, or place heavy objects on the instrument, and do not use excessive force on the buttons, switches or connectors.
- Do not use the instrument/device or headphones for a long period of time at a high or uncomfortable volume level, since this can cause permanent hearing loss. If you experience any hearing loss or ringing in the ears, consult a physician.

Yamaha cannot be held responsible for damage caused by improper use or modifications to the instrument, or data that is lost or destroyed.

Always turn the power off when the instrument is not in use.

Even when the [  ] (Standby/On) switch is in standby status (display is off), electricity is still flowing to the instrument at the minimum level.

When you are not using the instrument for a long time, make sure you disconnect the plug from the wall AC outlet.

Make sure to discard used batteries according to local regulations.

DMI-7 2/2

## **NOTICE**

**To avoid the possibility of malfunction/ damage to the product, damage to data, or damage to other property, follow the notices below.**

### ■ **Handling**

- Do not use the instrument in the vicinity of a TV, radio, stereo equipment, mobile phone, or other electric devices. Otherwise, the instrument, TV, or radio may generate noise.
- Do not expose the instrument to excessive dust or vibrations, or extreme cold or heat (such as in direct sunlight, near a heater, or in a car during the day) to prevent the possibility of panel discoloration, damage to the internal components or unstable operation. (Verified operating temperature range: 5° – 40°C, or 41° – 104°F.)
- Do not place vinyl, plastic or rubber objects on the instrument, since this might discolor the panel or keyboard.

### ■ **Maintenance**

- When cleaning the instrument, use a soft and dry cloth. Do not use paint thinners, solvents, alcohol, cleaning fluids, or chemical impregnated wiping cloths.

### ■ **Saving data**

- Some of the data of this instrument (page 7) are retained when the power is turned off. However, the saved data may be lost due to some failure, an operation mistake, etc.

## **Information**

### ■ **About copyrights**

- Copying of the commercially available musical data including but not limited to MIDI data and/or audio data is strictly prohibited except for your personal use.
- This product incorporates and bundles contents in which Yamaha owns copyrights or with respect to which Yamaha has license to use others' copyrights. Due to copyright laws and other relevant laws, you are NOT allowed to distribute media in which these contents are saved or recorded and remain virtually the same or very similar to those in the product.
  - \* The contents described above include a computer program, Accompaniment Style data, MIDI data, WAVE data, voice recording data, a score, score data, etc.
  - \* You are allowed to distribute medium in which your performance or music production using these contents is recorded, and the permission of Yamaha Corporation is not required in such cases.

### ■ **About functions/data bundled with the instrument**

- Some of the preset songs have been edited for length or arrangement, and may not be exactly the same as the original.

### ■ **About this manual**

- The illustrations and displays as shown in this manual are for instructional purposes only, and may appear somewhat different from those on your instrument.
- The company names and product names in this manual are the trademarks or registered trademarks of their respective companies.

Thank you for purchasing this Yamaha Digital Keyboard, the PSS-E30 Remie! Remie is loaded with various sound effects and Quiz function, so that even small children can enjoy playing it. We recommend that you read this manual carefully so that you can fully take advantage of the advanced and convenient functions of Remie. We also recommend that you keep this manual in a safe and handy place for future reference.

## Included Accessories

- Owner's Manual (this book) (1)
- USB cable (1)
- Online Member Product Registration (1)

## Song Book (Online Document)



### Song Book

Contains music scores for the preset Songs (excluding Song No. 001) of this instrument. To obtain this Song Book, access the Yamaha website, and click on the "Download" tab beneath the model name.

## Connecting Headphones or External Audio Equipment ([PHONES/OUTPUT] Jack)

For connecting a set of stereo headphones with a stereo mini plug. This jack also functions as an external output for sending the audio signal of this instrument to external audio equipment. The speakers of the instrument are automatically shut off when a headphones plug, etc. is inserted into this jack.

### CAUTION

- Before using the headphones, be sure to set the volume of the instrument at the minimum level. Then gradually raise the volume while playing the instrument, for your ear comfort and safety.
- Do not use the instrument or headphones for a long period of time at a high or uncomfortable volume level, since this can cause permanent hearing loss.
- Before connecting the instrument to other electronic components, make sure to set all volume levels to minimum, then turn off the power of all the components. Otherwise, damage to the components or electrical shock may occur.

### NOTICE

To avoid possible damage to the external device, first turn on the power to the instrument, then to the external device. When turning off the power, do so in reverse order: first turn off the power to the external device, then to the instrument.

Rear

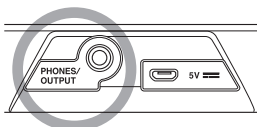

# Setting Up

Depending on how you are powering your instrument, follow one of the two power supply instructions below. This instrument does not include power supply accessories (with the exception of the USB cable), so make sure to purchase them separately as required.

### NOTICE

Use a USB cable of less than 3 meters. If the sound is degraded, make sure to use the included USB cable or turn down the master volume as needed.

## 1 Using a USB power adaptor or USB mobile battery, etc.

Connect the included USB cable and the commercially available USB power adaptor (or USB mobile battery) in the order shown in the illustration.

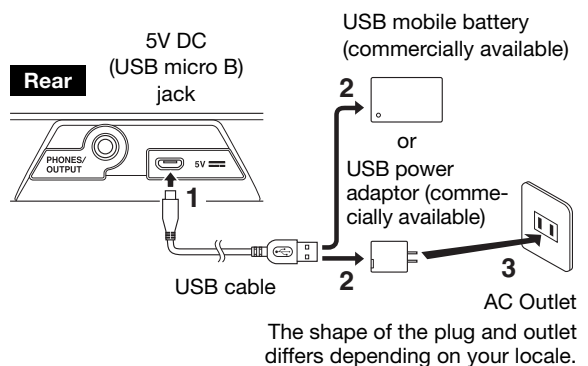

When disconnecting the USB cable or so, first turn off the power, then follow the order shown above in reverse.

### USB Power adaptor / USB mobile battery requirements

- Output voltage: 4.8 V to 5.2 V
- Output current: 0.5 A or greater

### CAUTION

Make sure to use a USB power adaptor or USB mobile battery with the specifications above. Using the wrong USB power adaptor can result in damage to the instrument or overheating. Read the safety precautions for your particular USB power adaptor or USB mobile battery.

### NOTICE

Some USB mobile batteries automatically stop supplying power when connected to a device with low current consumption, such as this instrument. Use a USB mobile battery that has a low-current mode function, etc., and can supply power to devices with current consumption of 40 mA or less.

## 2 Using Batteries

This instrument requires four “AA” size, Alkaline (LR6)/Manganese (R6) batteries, or rechargeable nickel-metal hydride batteries (rechargeable Ni-MH batteries). The Alkaline batteries or rechargeable Ni-MH batteries are recommended for this instrument, since other types may result in poorer battery performance.

### ⚠ WARNING

See the “Battery” section in the Precautions (page 4).

- 1 Make sure that the power of the instrument is off.
- 2 Open the battery compartment cover located on the instrument’s bottom panel.

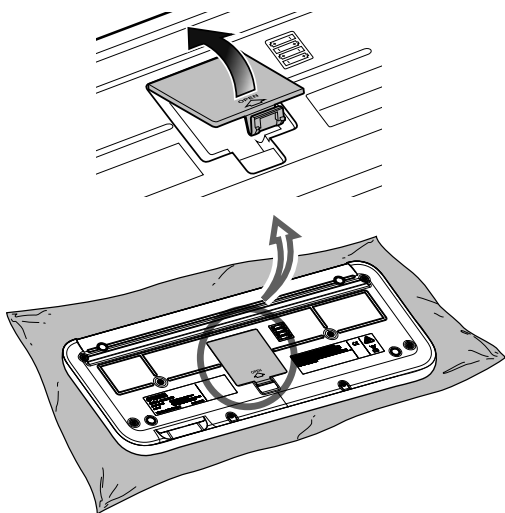

- 3 Insert the four new batteries, being careful to follow the polarity markings on the inside of the compartment.

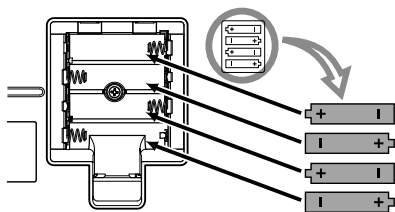

- 4 Replace the compartment cover, making sure that it locks firmly in place.

### NOTICE

- Make sure to set the Battery Type correctly (page 12). Failure to set the battery type may shorten the amount of the battery life.
- Connecting or disconnecting the USB cable with batteries installed may turn the power off, resulting in loss of data.

## Troubleshooting

Problem	Solution
<ul style="list-style-type: none"> <li>• No Sound.</li> <li>• The volume is too soft.</li> </ul>	<ul style="list-style-type: none"> <li>• Increase the volume.</li> <li>• Disconnect the headphones from [PHONES/OUTPUT] jack (page 6).</li> <li>• Check whether the Volume Limit setting (page 12) is too low or not.</li> <li>• Replace all the batteries with new ones or recharged ones.</li> </ul>
The sound is degraded or choppy.	Use the included USB cable or turn down the master volume.
Power suddenly and unexpectedly turns off.	This is normal and the Auto Power Off function may have been activated (page 12). If you need to disable the Auto Power Off function, select “OFF.”
When the instrument is turned on, power is turned off suddenly and unexpectedly.	The protection circuit has been activated due to overcurrent. This may occur when your USB power adaptor does not meet the requirements on page 6 or is damaged. Try to use another USB power adaptor that meets the requirements, etc. If it should appear to be malfunctioning, please consult Yamaha service personnel.

## Backup and Initialization

### • Backup Parameters

The following settings will be maintained even if the power is turned off.

Master Volume, Volume Limit, Tuning, Chord Fingering Type, Auto Power Off, Battery Type

### NOTICE

The power is turned off when the USB power adaptor is unplugged with the power on or the alkaline / manganese battery runs down.

### • Initialization

You can initialize the backup parameters via the following method.

While holding down the highest white key, press the [⏻] (Standby/On) switch to turn the power on. “L L” appears on the display.

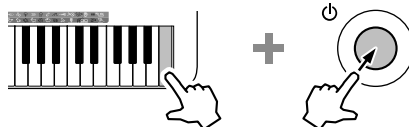

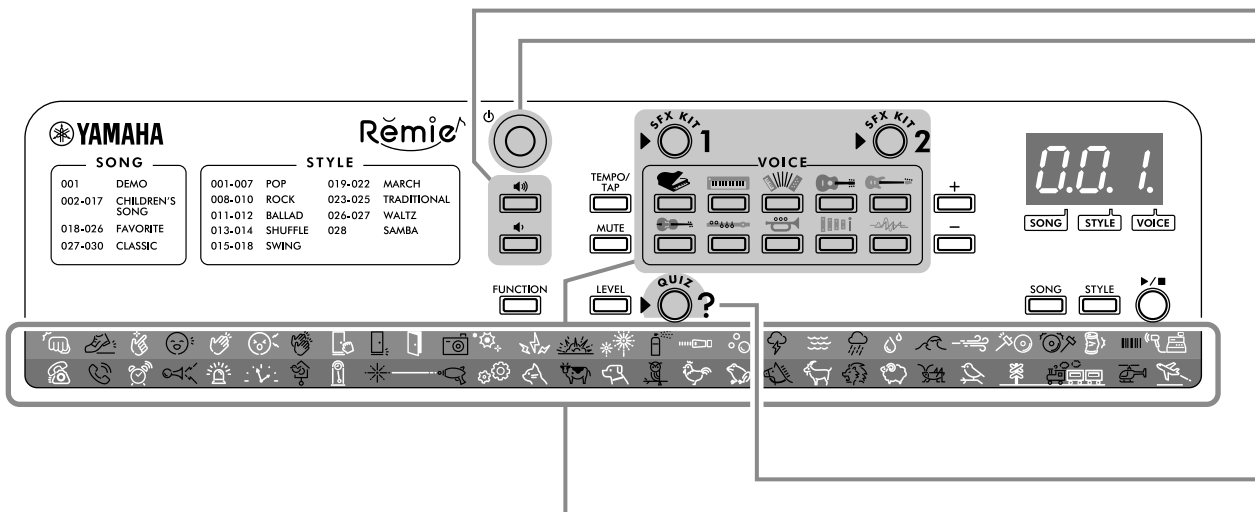

## Play the Keyboard and Check Out the Voices!

🎵 Select an instrument Voice and play it 🎵

1. Press the button with the musical instrument illustration as below.

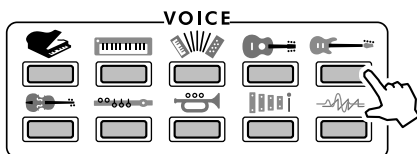

### ★ MEMO ★

The instrument Voice changes each time you press the musical instrument's button. For details about the Voices, refer to the "Voice List" on page 14.

2. Play the keyboard.

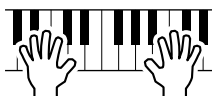

🎵 Play some of the fun sound effects 🎵

1. Press or .

You can play the sound effect that matches the illustration above the keyboards.

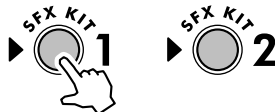

### ★ MEMO ★

Sound effects are applied to the keys without illustration. For details, please refer to the "Drum/SFX Kit List" on page 15.

2. Play the keyboard with your favorite sound effect.

Pressing lets you play the upper illustration sounds, and pressing lets you play the lower illustration sounds.

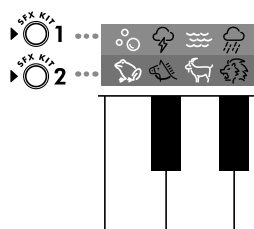



## Turning the Power On/Off

Press  to turn on the power.  
“00 1” appears on the display.

To set the power to standby, press and hold the switch for about a second.

### ★ MEMO ★

If Remie is not operated for 30 minutes (by default) with the power on, the power is automatically turned off (Auto Power function; page 12).

## Adjusting the Volume

Press  to increase the volume.

Press  to decrease the volume.

### ★ MEMO ★

- The volume level can be changed from 00 to 15. The default level is 13.
- Remie has a Volume Limit function to prevent the Master Volume from accidentally being set to too high a level. For details, refer to page 12.

# Try the Quiz — and guess the sound!

## 1. Select the sound you want to guess.

Pressing  or  lets you to guess the fun sounds.



## 2. Press ? .

When the fanfare plays, the Quiz starts!



## 3. Play the same key as the sound from

*Remie*^.

There are a total of 10 questions.

To quit the Quiz, press  ? again.



## RULES

- The answer time is about 10 seconds.
- If your answer is correct, a bell sounds.
- If your answer is incorrect, a buzzer sounds.
- If you do not play any key for 10 seconds, a buzzer sounds.
- You can try the same Quiz question three times.
- If you cannot play the correct key within three times, a final buzzer sounds and the next question starts.

### ★ MEMO ★

Pressing the [LEVEL] button lets you select the difficulty level of the Quiz. The level changes each time you press the button. The default setting is “Auto (AUT).”

**LEVEL 1:** 1 note sounds.

**LEVEL 2:** 3 notes sound one-by-one.

**LEVEL 3:** 3 notes sound simultaneously.

**Auto:** The level changes from LEVEL 1 to LEVEL 3 according to the number of correct answers.

# Listen to the Song, and try playing along!

Remie<sup>^</sup> contains 30 preset Songs.

First, press . The Song number (page 16) appears on the display.





You can select or listen to the Song while this dot is lit.

## Listen to the Song!

Press  to start Song playback.

To stop playback, press the button again.

Listen to various Songs referring to the “Song List” on page 16.

Pressing  or  lets you select the previous or next Song.

Pressing  lets you select the top Song of the next category.

## Try playing along with the Song!

1. Select your favorite Song.

2. Press .

The melody part of the Song is muted.

Pressing  again lets you listen to the melody part.

3. Press  to start Song playback.

4. Play the melody part referring to the Song Book (page 6).

### ★ MEMO ★

- You cannot mute the melody part of the Demo Song (Song No.1).
- You can download the Song Book (page 6) from the Yamaha website. For details, refer to the “Song Book (Online Document)” on page 6.

## Changing the Tempo

Press the [TEMPO/TAP] button to change the Tempo of the Song, Style, and Metronome (page 12). Use the [+] and [-] buttons to change the Tempo value while “t E P” or the current Tempo value is shown on the display.

### ● Tapping out a Tempo – Tap Start

While Song/Style playback is stopped, tap the [TEMPO/TAP] button several times to start playback at the tapped tempo- four times for a 4-beat Song/Style or three times for a 3-beat Song/Style.

# Try playing with the Rhythm and Accompaniment (Styles)!

Remie<sup>^</sup> includes an Auto Accompaniment feature that automatically plays appropriate “Styles” (rhythm+bass+chord accompaniment), controlled simply by playing chords with your left hand.



First, press . The Style number (page 16) appears on the display.



You can select or play rhythm or accompaniment while this dot is lit.

1. Press  to start the rhythm.
2. Play a key in the Accompaniment Section (Smart Chord) in the illustration below to start the accompaniment.

Select your favorite Style referring to the “Style List” on page 16.

Pressing  or  lets you select the previous or next Style.

Pressing  lets you select the top Style of the next category.

3. Try playing the melody part using the keys C3 and above, as shown at right.

For details on how to play with a Style, refer to the “How to play with a Style” on page 13.

4. Press  to stop the rhythm or Auto Accompaniment.

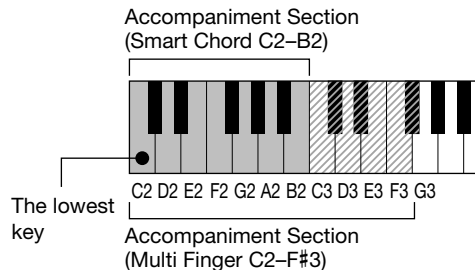

## ★ MEMO ★

### Playing the accompaniment

Remie includes a “Smart Chord” feature that lets you start and control Styles by simply pressing a single note of a chord in the Accompaniment Section in the illustration above. If you want to play full chords yourself, change the “Chord Fingering Type” (page 12) from “Smart Chord (5/7r)” to “Multi Finger (7/4 t).” For details, refer to the “Chords for Style Playback” on page 17.

- To play back the rhythm part only, press the [MUTE] button before or during the Style playback. Pressing the [MUTE] button again lets you start the accompaniment again.

## Sync Start Function for Song/Style



This function lets you start the Song/Style by simply playing a key or chord. For details, refer to page 12.

# The Functions

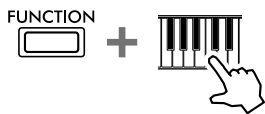

To set the various Functions, press the appropriate key (repeatedly if necessary) while holding down **FUNCTION**.

FUNCTION

FUNCTION

C#2 D#2 F#2 G#2 A#2 C#3 D#3 F#3 G#3 A#3 C#4 D#4

On/Off -1 +1 -0.2 +0.2 -1 +1 -1 +1 On/Off Smart Chord / Multi Finger Refer to page 17. Default Refer to page 17. Alkaline / Rechargeable Off/5/10/15/30/60/120 -1 +1

C2 D2 E2 F2 G2 A2 B2 C3 D3 E3 F3 G3 A3 B3 C4 D4 E4

① Sustain ② Transpose ③ Tuning ④ Metronome ⑤ Metronome Beat ⑥ Song/Style/Metronome Volume ⑦ Sync Start ⑧ Chord Fingering Type ⑨ Smart Chord Key ⑩ Battery Type ⑪ Auto Power Off ⑫ Volume Limit

## Function List

Function Name	Descriptions	Default Value	Range/Settings
① Sustain	Switches the Sustain function on/off.	Off (5oF)	On (5on) / Off (5oF)
② Transpose	Determines the pitch of the instrument in semitone increments.	00	-12-0-12
③ Tuning	Determines the fine tuning of the pitch of the entire instrument in approx. 0.2Hz increments. The hundreds digit of the setting value is omitted on the display.	440.0 (400)	427.0 (270)- 440.0 (400)- 453.0 (530)
④ Metronome	Switches the Metronome function on/off.	Off (oFF)	On (on) / Off (oFF)
⑤ Metronome Beat	Determines the Metronome beat. For example, when this is set to 4, the beat is set to 4/4 time and the first beat is accented with a bell sound.	The current Song or Style Beat	0 (no bell)-16
⑥ Song/Style/Metronome Volume	Determines the Song/Style/Metronome volume.	12	00-15
⑦ Sync Start	Switches the Sync Start function on/off. When this function is on, the Song/Style number on the display flashes and you can start the Song/Style by simply playing a key or chord.  ★ MEMO ★ The preset Songs in Remie contain a silent measure at the beginning of each Song. This is why, even if the Sync Start function is on, Song playback does not start immediately after playing a key or a chord.	Off	On (Song/Style No. on the display flashes.) / Off
⑧ Chord Fingering Type	Determines how to play the chord in Accompaniment Section (page 11) when playing with a Style.  • Smart Chord (5rr): Play only the root key of the chord. • Multi Finger (rlt): Play all notes of the chord conventionally.	Smart Chord (5rr)	Smart Chord (5rr) / Multi Finger (rlt)
⑨ Smart Chord Key	Determines the Key Signature when the Chord Fingering Type is set to "Smart Chord." For example, if there are 2 sharps (#) on your music score (indicating the key of D; refer to the "How to play with a Style" on page 13), press A3 or G3 key until "5P2" appears on the display. For details, refer to the "Chords for Style Playback" on page 17.	No Key Signature (5P0: C Major or A Minor)	7 Flats (FL 7)-0 (5P0)- 7 Sharps (5P 7)
⑩ Battery Type	Selects the type of batteries you have installed to Remie.	Alkaline battery / Manganese battery (RL)	RL: Alkaline battery / Manganese battery rL: Rechargeable battery
⑪ Auto Power Off	Specifies the time that will elapse before the instrument's power is automatically turned off.	30 minutes	oFF/5/10/15/30/60/120 (minutes)
⑫ Volume Limit	Determines the maximum value of the Master Volume.	15	01-15

# Specifications

<b>Product Name</b>		Digital Keyboard
<b>Size/Weight</b>	<b>Dimensions (W x D x H)</b>	506 mm x 201 mm x 54 mm (19-15/16" x 7-15/16" x 2-1/8")
	<b>Weight</b>	1.2 kg (2 lb, 10 oz) (not including batteries)
<b>Control Interface</b>	<b>Keyboard</b>	37 HQ (High Quality) Mini Keys
	<b>Display</b>	7-Segment LED
	<b>Panel Language</b>	English
<b>Voices</b>	<b>Polyphony (max.)</b>	32
	<b>Number of Voices</b>	49 (46 Voices + 1 Drum Kit + 2 SFX Kits (74 sound effects))
<b>Accompaniment Styles</b>	<b>Number of Styles</b>	28
	<b>Fingering</b>	Smart Chord, Multi Finger
<b>Songs</b>	<b>Number of Preset Songs</b>	30
	<b>Panel Sustain</b>	Yes
	<b>Metronome</b>	Yes
	<b>Tempo Range</b>	11–280, Tap Tempo (32–280)
	<b>Tuning</b>	427.0–440.0–453.0 Hz (approx. 0.2 Hz increments)
<b>Connectivity</b>		Headphones/Output (Stereo mini) jack, 5V DC (USB micro B) jack
<b>Sound System</b>	<b>Amplifiers</b>	1.4 W
	<b>Speakers</b>	8 cm x 1
<b>Power Supply</b>	<b>Power Supply</b>	<ul style="list-style-type: none"> <li>• USB power adaptor 5V/500mA</li> <li>• Four "AA" size alkaline (LR6), manganese (R6) or Ni-MH rechargeable batteries (HR6)</li> </ul>
	<b>Power Consumption</b>	1.5 W
	<b>Auto Power Off</b>	Yes
<b>Included Accessories</b>		<ul style="list-style-type: none"> <li>• Owner's Manual</li> <li>• USB cable</li> <li>• Online Member Product Registration</li> </ul>
<b>Separately Sold Accessories (May not be available depending on your area.)</b>		Headphones (HPH-50/HPH-100/HPH-150)

\* The contents of this manual apply to the latest specifications as of the publishing date.  
 To obtain the latest manual, access the Yamaha website then download the manual file.  
 Since specifications, equipment or separately sold accessories may not be the same in every locale, please check with your Yamaha dealer.

## How to play with a Style

Styles let you produce rhythm and automatic accompaniment playback simply by playing the desired chords.

Select Style No. 11 and try playing the Song below!

**Twinkle Twinkle Little Star**

**Right**





**Left**

The # and ♭ marks here indicate the Key Signature.  
 If # (sharps) or ♭ (flats) are written here, make sure to set the Key Signature to match that of your music score referring to the "⑨ Smart Chord Key" on page 12.  
 For details, refer to the "Chords for Style Playback" on page 17.

When setting "⑧ Chord Fingering Type" on page 12 to "Smart Chord (5 Finger)", play only the root note (★). For details on how to play chords when "Multi Finger (7 L &)" is set, refer to the "Chords for Style Playback" on page 17.



# Voice List

Voice No.	Voice Name
 <b>PIANO</b>	
1	Grand Piano
2	Piano & Strings
3	Honky Tonk Piano
4	Harpsichord
 <b>ELECTRIC PIANO</b>	
5	Electric Piano 1
6	Electric Piano 2
7	Electric Piano Pad
 <b>ORGAN</b>	
8	Accordion
9	Tango Accordion
10	Harmonica
11	Drawbar Organ
12	Pipe Organ
 <b>GUITAR</b>	
13	Nylon Guitar
14	Steel Guitar
15	Clean Guitar
16	Overdriven Guitar
 <b>BASS</b>	
17	Acoustic Bass
18	Finger Bass
19	Slap Bass
20	Synth Bass
 <b>STRINGS</b>	
21	Strings
22	Pizzicato Strings
23	Violin
24	Cello
25	Contrabass
26	Orchestral Harp

Voice No.	Voice Name
 <b>WOODWIND</b>	
27	Flute
28	Oboe
29	Clarinet
30	Bassoon
31	Sax
 <b>BRASS</b>	
32	Brass Section
33	Trumpet
34	Trombone
35	Tuba
36	Synth Brass
 <b>PERCUSSION</b>	
37	Vibraphone
38	Marimba
39	Celesta
40	Timpani
41	Drum Kit
 <b>SYNTH</b>	
42	Square Lead
43	Sawtooth Lead
44	New Age Pad
45	Halo Pad
46	Crystal
47	Brightness
<b>SFX KIT</b>	
48	SFX Kit 1
49	SFX Kit 2

When you select "Drum Kit (Voice No. 41)" or "SFX Kit 1 (Voice No. 48)" or "SFX Kit 2 (Voice No. 49)," various drum/percussion or SFX sounds are assigned to individual keys. For details on assigning instruments to keys, refer to the "Drum/SFX Kit List" on page 15.

# Drum/SFX Kit List

The lowest key		Voice No. 41		Voice No. 48		Voice No. 49	
		Drum Kit		SFX Kit 1		SFX Kit 2	
C2	C 2	Castanet	C 2	 Punch	C 2	 Telephone	
<b>C#2</b>	C# 2	Brush Slap	C# 2	 Footsteps	C# 2	 Dial Tone	
D2	D 2	Brush Tap Swirl	D 2	 Finger Snap	D 2	 Alarm Bell	
<b>D#2</b>	D# 2	Open Rim Shot	D# 2	 Laugh	D# 2	 Bicycle Horn	
E2	E 2	Bass Drum	E 2	 Handclap	E 2	 Siren	
F2	F 2	Snare	F 2	 Scream	F 2	 Clock Tick	
<b>F#2</b>	F# 2	Side Stick	F# 2	 Applause	F# 2	 Cuckoo Clock	
G2	G 2	Floor Tom	G 2	 Knock On A Door	G 2	 Big Clock	
<b>G#2</b>	G# 2	Hi-Hat Closed	G# 2	 Door Slam	G# 2	 Laser 1	
A2	A 2	Low Tom	A 2	 Door Squeak	A 2	 Laser 2	
<b>A#2</b>	A# 2	Hi-Hat Open	A# 2	 Camera 1	A# 2	 Laser 3	
B2	B 2	Mid Tom	B 2	 Camera 2	B 2	 Gear	
C3	C 3	Crash Cymbal	C 3	 Short Circuit	C 3	 Cat	
<b>C#3</b>	C# 3	Tambourine	C# 3	 Explosion	C# 3	 Cow	
D3	D 3	Ride Cymbal Cup	D 3	 Firework	D 3	 Dog	
<b>D#3</b>	D# 3	Ride Cymbal	D# 3	 Spray	D# 3	 Owl	
E3	E 3	Bongo H	E 3	 Zipper	E 3	 Rooster	
F3	F 3	Bongo L	F 3	 Bubble	F 3	 Frog	
<b>F#3</b>	F# 3	Conga H Mute	F# 3	 Thunder	F# 3	 Horse	
G3	G 3	Conga H Open	G 3	 Stream	G 3	 Goat	
<b>G#3</b>	G# 3	Conga L	G# 3	 Rain	G# 3	 Lion	
A3	A 3	Timbale H	A 3	 Waterdrop	A 3	 Sheep	
<b>A#3</b>	A# 3	Timbale L	A# 3	 Wave	A# 3	 Insect	
B3	B 3	Cowbell	B 3	 Wind	B 3	 Bird	
C4	C 4	Vibraslap	C 4	 Gong 1	C 4	 Railroad Crossing	
<b>C#4</b>	C# 4	Surdo Open	C# 4	 Gong 2	C# 4	 Steam Engine Whistle	
D4	D 4	Agogo H	D 4	 Kick A Can	D 4	 Train	
<b>D#4</b>	D# 4	Agogo L	D# 4	 Barcode Scanner	D# 4	 Helicopter	
E4	E 4	Wood Block H	E 4	 Cash Register Drawer	E 4	 Jet Plane	
F4	F 4	Wood Block L	F 4	Chime	F 4	Car Engine Ignition	
<b>F#4</b>	F# 4	Guiro Short	F# 4	Question Setting	F# 4	Car Blinker	
G4	G 4	Guiro Long	G 4	Announcement Start	G 4	Car Tires Squeal	
<b>G#4</b>	G# 4	Cabasa	G# 4	Correct	G# 4	Car Horn	
A4	A 4	Triangle Mute	A 4	Announcement End	A 4	Car Passing	
<b>A#4</b>	A# 4	Triangle Open	A# 4	Wrong	A# 4	Car Crash	
B4	B 4	Jingle Bells	B 4	Metallic Sound	B 4	UFO	
C5	C 5	Bell Tree	C 5	Chau Gong	C 5	Starship	

# Song List

Category	Song No.	Song Name	Composer
<b>DEMO</b>	1	Demo	ORIGINAL
<b>CHILDREN'S SONG</b>	2	Frère Jacques	Traditional
	3	Der Froschgesang	Traditional
	4	London Bridge	Traditional
	5	Sur le pont d'Avignon	Traditional
	6	Nedelka	Traditional
	7	Sippin' Cider Through a Straw	Traditional
	8	If You're Happy and You Know It	Traditional
	9	Ten Little Indians	Traditional
	10	The Cuckoo	Traditional
	11	Close Your Hands, Open Your Hands	J. J. Rousseau
	12	O du lieber Augustin	Traditional
	13	Twinkle Twinkle Little Star	Traditional
	14	Im Mai	Traditional
	15	Pop Goes The Weasel	Traditional
	16	Mary Had a Little Lamb	Traditional
	17	Row Row Row Your Boat	Traditional
	<b>FAVORITE</b>	18	Holdilia Cook
19		Beautiful Dreamer	S. C. Foster
20		La Cucaracha	Traditional
21		Greensleeves	Traditional
22		Wenn ich ein Vöglein wär	Traditional
23		Die Lorelei	F. Silcher
24		Silent Night	F. Gruber
25		Deck the Halls	Traditional
26		Annie Laurie	Traditional
<b>CLASSIC</b>	27	Liebesträume Nr.3	F. Liszt
	28	Humoresques	A. Dvořák
	29	Pizzicato Polka	J. Strauss II
	30	Menuett BWV Anh.114	J. S. Bach

# Style List

Style No.	Style Name
<b>Pop</b>	
1	8Beat 1
2	8Beat 2
3	8Beat 3
4	16Beat
5	EuroPop
6	Folkrock 1
7	Folkrock 2
<b>Rock</b>	
8	Rock
9	8BeatRock
10	16BeatRock

Style No.	Style Name
<b>Ballad</b>	
11	Ballad 1
12	Ballad 2
<b>Shuffle</b>	
13	Shuffle 1
14	Shuffle 2
<b>Swing</b>	
15	Swing
16	Singalong
17	Charleston
18	WinterSwing

Style No.	Style Name
<b>March</b>	
19	March 1
20	March 2
21	March 3
22	6/8March
<b>Traditional</b>	
23	Polka 1
24	Polka 2
25	Bluegrass
<b>Waltz</b>	
26	Waltz 1
27	Waltz 2
<b>Samba</b>	
28	Samba



# Chords for Style Playback

The method for playing chords and the actual sound of the chords differ depending on the Chord Fingering Type (page 12); Smart Chord or Multi Finger.

## ● In the case of “Smart Chord”

When the Chord Fingering Type is set to “Smart Chord (57r),” make sure to set the “Smart Chord Key” (page 12) at first.

### Smart Chord Key Setting

Make sure to set “Smart Chord Key” to match the Key Signature (# or ♭) on your music score before starting the Style (Auto Accompaniment). To set the number of the Key Signature on the music score, press the G3 or A3 key while holding down the [FUNCTION] button.

Pressing the G3 key increases the number of flats and decreases the sharps. Pressing A3 key increases the number of sharps and decreases the flats. For the position of the G3 or A3 key, refer to the “⑨ Smart Chord Key” in the illustration on page 12.

### Smart Chord Chart

When you set the Smart Chord Key to match the Key Signature on your music score, you can play a chord by simply playing the root note of the chord you want to play. This chart features common chords you can play using “Smart Chords.”

Key Signature on the music score	Display	Root Note						
		C	D	E♭	F	G	A	B♭
2 flats (♭)	FL2	C min	D 1+5	E♭ Major	F 7	G min	A m7(♭5)	B♭ Major
Key Signature on the music score	Display	Root Note						
		C	D	E	F	G	A	B♭
1 flat (♭)	FL1	C 7	D min	E m7(♭5)	F Major	G min	A 1+5	B♭ Major
Key Signature on the music score	Display	Root Note						
		C	D	E	F	G	A	B
No sharps/flats	SP0	C Major	D min	E 1+5	F Major	G 7	A min	B m7(♭5)
Key Signature on the music score	Display	Root Note						
		C	D	E	F♯	G	A	B
1 sharp (♯)	SP1	C Major	D 7	E min	F♯ m7(♭5)	G Major	A min	B 1+5
Key Signature on the music score	Display	Root Note						
		C♯	D	E	F♯	G	A	B
2 sharps (♯)	SP2	C♯ m7(♭5)	D Major	E min	F♯ 1+5	G Major	A 7	B min

## ● In the case of “Multi Finger”

When the Chord Fingering Type is set to “Multi Finger (71L L),” play all keys of a chord you want to play. This chart features common chords. For other chords, refer to commercially available chord books for further details.

★ Indicates the root note.

Major	Minor	Seventh	Minor Seventh	Major Seventh
<b>C</b> 	<b>Cm</b> 	<b>C7</b> 	<b>Cm7</b> 	<b>CM7</b> 
<b>F</b> 	<b>Fm</b> 	<b>F7</b> 	<b>Fm7</b> 	<b>FM7</b> 
<b>G</b> 	<b>Gm</b> 	<b>G7</b> 	<b>Gm7</b> 	<b>GM7</b> 



## LIMITED 1-YEAR WARRANTY ON PORTABLE KEYBOARDS

**(NP, PSRE, PSREW, PSRF, PSRI, PSS, SHS, EZ, DGX230, DGX530, YPG AND YPT SERIES)**

Thank you for selecting a Yamaha product. Yamaha products are designed and manufactured to provide a high level of defect-free performance. Yamaha Corporation of America ("Yamaha") is proud of the experience and craftsmanship that goes into each and every Yamaha product. Yamaha sells its products through a network of reputable, specially authorized dealers and is pleased to offer you, the Original Owner, the following Limited Warranty, which applies only to products that have been (1) directly purchased from Yamaha's authorized dealers in the fifty states of the USA and District of Columbia (the "Warranted Area") and (2) used exclusively in the Warranted Area. Yamaha suggests that you read the Limited Warranty thoroughly and invites you to contact your authorized Yamaha dealer or Yamaha Customer Service if you have any questions.

**Coverage:** Yamaha will, at its option, repair or replace the product covered by this warranty if it becomes defective, malfunctions or otherwise fails to conform with this warranty under normal use and service during the term of this warranty, without charge for labor or materials. Repairs may be performed using new or refurbished parts that meet or exceed Yamaha specifications for new parts. If Yamaha elects to replace the product, the replacement may be a reconditioned unit. You will be responsible for any installation or removal charges and for any initial shipping charges if the product(s) must be shipped for warranty service. However, Yamaha will pay the return shipping charges to any destination within the USA if the repairs are covered by the warranty. This warranty does not cover (a) damage, deterioration or malfunction resulting from accident, negligence, misuse, abuse, improper installation or operation or failure to follow instructions according to the Owner's Manual for this product; any shipment of the product (claims must be presented to the carrier); repair or attempted repair by anyone other than Yamaha or an authorized Yamaha Service Center; (b) any unit which has been altered or on which the serial number has been defaced, modified or removed; (c) normal wear and any periodic maintenance; (d) deterioration due to perspiration, corrosive atmosphere or other external causes such as extremes in temperature or humidity; (e) damages attributable to power line surge or related electrical abnormalities, lightning damage or acts of God; or (f) RFI/EMI (Interference/noise) caused by improper grounding or the improper use of either certified or uncertified equipment, if applicable. Any evidence of alteration, erasing or forgery of proof-of-purchase documents will cause this warranty to be void. This warranty covers only the Original Owner and is not transferable.

**In Order to Obtain Warranty Service:** Warranty service will only be provided for defective products within the Warranted Area. Contact your local authorized Yamaha dealer who will advise you of the procedures to be followed. If this is not successful, contact Yamaha at the address, telephone number or website shown below. Yamaha may request that you send the defective product to a local authorized Yamaha Servicer or authorize return of the defective product to Yamaha for repair. If you are uncertain as to whether a dealer has been authorized by Yamaha, please contact Yamaha's Service Department at the number shown below, or check Yamaha's website at [www.yamaha.com](http://www.yamaha.com). Product(s) shipped for service should be packed securely and must be accompanied by a detailed explanation of the problem(s) requiring service, together with the original or a machine reproduction of the bill of sale or other dated, proof-of-purchase document describing the product, as evidence of warranty coverage. Should any product submitted for warranty service be found ineligible therefore, an estimate of repair cost will be furnished and the repair will be accomplished only if requested by you and upon receipt of payment or acceptable arrangement for payment.

**Limitation of Implied Warranties and Exclusion of Damages:** ANY IMPLIED WARRANTIES, INCLUDING WARRANTIES OF MERCHANTABILITY AND FITNESS FOR A PARTICULAR PURPOSE SHALL BE LIMITED IN DURATION TO THE APPLICABLE PERIOD OF TIME SET FORTH ABOVE. YAMAHA SHALL NOT BE RESPONSIBLE FOR INCIDENTAL OR CONSEQUENTIAL DAMAGES OR FOR DAMAGES BASED UPON INCONVENIENCE, LOSS OF USE, DAMAGE TO ANY OTHER EQUIPMENT OR OTHER ITEMS AT THE SITE OF USE OR INTERRUPTION OF PERFORMANCES OR ANY CONSEQUENCES. YAMAHA'S LIABILITY FOR ANY DEFECTIVE PRODUCT IS LIMITED TO REPAIR OR REPLACEMENT OF THE PRODUCT, AT YAMAHA'S OPTION. SOME STATES DO NOT ALLOW LIMITATIONS ON HOW LONG AN IMPLIED WARRANTY LASTS OR THE EXCLUSION OR LIMITATION OF INCIDENTAL OR CONSEQUENTIAL DAMAGES, SO THE ABOVE LIMITATION OR EXCLUSION MAY NOT APPLY TO YOU. This Warranty gives you specific legal rights, and you may also have other rights which vary from state to state. This is the only express warranty applicable to the product specified herein; Yamaha neither assumes nor authorizes anyone to assume for it any other express warranty.

If you have any questions about service received or if you need assistance in locating an authorized Yamaha Servicer, please contact:



CUSTOMER SERVICE

Yamaha Corporation of America

6600 Orangethorpe Avenue, Buena Park, California 90620-1373

Telephone: 800-854-1569

[www.yamaha.com](http://www.yamaha.com)

**Do not return any product to the above address without a written Return Authorization issued by YAMAHA.**

© 2019 Yamaha Corporation of America.

## NORTH AMERICA

### CANADA

**Yamaha Canada Music Ltd.**  
135 Milner Avenue, Toronto, Ontario M1S 3R1,  
Canada  
Tel: +1-416-298-1311

### U.S.A.

**Yamaha Corporation of America**  
6600 Orangethorpe Avenue, Buena Park, CA 90620,  
U.S.A.  
Tel: +1-714-522-9011

## CENTRAL & SOUTH AMERICA

### MEXICO

**Yamaha de México, S.A. de C.V.**  
Av. Insurgentes Sur 1647 Piso 9, Col. San José  
Insurgentes, Delegación Benito Juárez, CDMX,  
C.P. 03900, México  
Tel: +52-55-5804-0600

### BRAZIL

**Yamaha Musical do Brasil Ltda.**  
Praça Professor José Lannes, 40-Cjs 21 e 22, Brooklin  
Paulista Novo CEP 04571-100 – São Paulo – SP,  
Brazil  
Tel: +55-11-3704-1377

### ARGENTINA

**Yamaha Music Latin America, S.A.,  
Sucursal Argentina**  
Olga Cossetini 1553, Piso 4 Norte,  
Madero Este-C1107CEK,  
Buenos Aires, Argentina  
Tel: +54-11-4119-7000

### PANAMA AND OTHER LATIN AMERICAN REGIONS/ CARIBBEAN REGIONS

**Yamaha Music Latin America, S.A.**  
Edificio Torre Davivienda, Piso: 20  
Avenida Balboa, Marbella, Corregimiento de Bella  
Vista, Ciudad de Panamá, Rep. de Panamá  
Tel: +507-269-5311

## EUROPE

### THE UNITED KINGDOM/IRELAND

**Yamaha Music Europe GmbH (UK)**  
Sherbourne Drive, Tilbrook, Milton Keynes,  
MK7 8BL, U.K.  
Tel: +44-1908-366700

### GERMANY

**Yamaha Music Europe GmbH**  
Siemensstrasse 22-34, 25462 Rellingen, Germany  
Tel: +49-4101-303-0

### SWITZERLAND/LIECHTENSTEIN

**Yamaha Music Europe GmbH, Branch  
Switzerland in Thalwil**  
Seestrasse 18a, 8800 Thalwil, Switzerland  
Tel: +41-44-3878080

### AUSTRIA/CROATIA/CZECH REPUBLIC/ HUNGARY/ROMANIA/SLOVAKIA/ SLOVENIA

**Yamaha Music Europe GmbH, Branch Austria**  
Schleiergasse 20, 1100 Wien, Austria  
Tel: +43-1-60203900

### POLAND

**Yamaha Music Europe  
Sp.z o.o. Oddział w Polsce**  
ul. Wielicka 52, 02-657 Warszawa, Poland  
Tel: +48-22-880-08-88

### BULGARIA

**Dinacord Bulgaria LTD.**  
Bul. Iskarsko Schose 7 Targowski Zentar Ewropa  
1528 Sofia, Bulgaria  
Tel: +359-2-978-20-25

### MALTA

**Olimpus Music Ltd.**  
Valletta Road, Mosta MST9010, Malta  
Tel: +356-2133-2093

### NETHERLANDS/BELGIUM/ LUXEMBOURG

**Yamaha Music Europe, Branch Benelux**  
Clarissenhof 5b, 4133 AB Vianen, The Netherlands  
Tel: +31-347-358040

### FRANCE

**Yamaha Music Europe**  
7 rue Ambroise Croizat, Zone d'activités de Pariest,  
77183 Croissy-Beaubourg, France  
Tel: +33-1-6461-4000

### ITALY

**Yamaha Music Europe GmbH, Branch Italy**  
Via Tinelli N.67/69 20855 Gerno di Lesmo (MB),  
Italy  
Tel: +39-039-9065-1

### SPAIN/PORTUGAL

**Yamaha Music Europe GmbH Ibérica, Sucursal  
en España**  
Ctra. de la Coruña km. 17,200, 28231  
Las Rozas de Madrid, Spain  
Tel: +34-91-639-88-88

### GREECE

**Philippos Nakas S.A. The Music House**  
19th klm. Leof. Lavriou 190 02 Peania – Attiki,  
Greece  
Tel: +30-210-6686260

### SWEDEN

**Yamaha Music Europe GmbH Germany Filial  
Scandinavia**  
JA Wettergrensgata 1, 400 43 Göteborg, Sweden  
Tel: +46-31-89-34-00

### DENMARK

**Yamaha Music Denmark,  
Fillial of Yamaha Music Europe GmbH, Tyskland**  
Generatorvej 8C, ST. TH., 2860 Soborg, Denmark  
Tel: +45-44-92-49-00

### FINLAND

**F-Musiikki Oy**  
Antaksentie 4  
FI-01510 Vantaa, Finland  
Tel: +358 (0)96185111

### NORWAY

**Yamaha Music Europe GmbH Germany -  
Norwegian Branch**  
Grini Næringspark 1, 1332 Østerås, Norway  
Tel: +47-6716-7800

### ICELAND

**Hljóðfaerahúsid Ehf.**  
Sidumula 20  
IS-108 Reykjavik, Iceland  
Tel: +354-525-5050

### CYPRUS

**Nakas Music Cyprus Ltd.**  
Nikis Ave 2k  
1086 Nicosia  
Tel: +357-22-511080  
**Major Music Center**  
21 Ali Riza Ave. Ortakoy  
P.O.Box 475 Lefkoşa, Cyprus  
Tel: (392) 227 9213

### RUSSIA

**Yamaha Music (Russia) LLC.**  
Room 37, entrance 7, bld. 7, Kievskaya street,  
Moscow, 121059, Russia  
Tel: +7-495-626-5005

### OTHER EUROPEAN REGIONS

**Yamaha Music Europe GmbH**  
Siemensstrasse 22-34, 25462 Rellingen, Germany  
Tel: +49-4101-303-0

## AFRICA

**Yamaha Music Gulf FZE**  
JAFZA-16, Office 512, P.O.Box 17328,  
Jebel Ali FZE, Dubai, UAE  
Tel: +971-4-801-1500

## MIDDLE EAST

### TURKEY

**Yamaha Music Europe GmbH  
Merkezi Almanya Türkiye Istanbul Subesi**  
Mor Sumbul Sokak Varyap Meridian Business  
1. Blok No:1 113-114-115  
Bati Atasehir Istanbul, Turkey  
Tel: +90-216-275-7960

### ISRAEL

**RBX International Co., Ltd.**  
P.O. Box 10245, Petach-Tikva, 49002  
Tel: (972) 3-925-6900

### OTHER REGIONS

**Yamaha Music Gulf FZE**  
JAFZA-16, Office 512, P.O.Box 17328,  
Jebel Ali FZE, Dubai, UAE  
Tel: +971-4-801-1500

## ASIA

### THE PEOPLE'S REPUBLIC OF CHINA

**Yamaha Music & Electronics (China) Co., Ltd.**  
2F, Yunhedasha, 1818 Xinzha-lu, Jingan-qu,  
Shanghai, China  
Tel: +86-400-051-7700

### HONG KONG

**Tom Lee Music Co., Ltd.**  
11/F., Silvercord Tower 1, 30 Canton Road,  
Tsimshatsui, Kowloon, Hong Kong  
Tel: +852-2737-7688

### INDIA

**Yamaha Music India Private Limited**  
P-401, JMD Megapolis, Sector-48, Sohna Road,  
Gurugram-122018, Haryana, India  
Tel: +91-124-485-3300

### INDONESIA

**PT Yamaha Musik Indonesia Distributor**  
Yamaha Music Center Bldg. Jalan Jend. Gatot  
Subroto Kav. 4, Jakarta 12930, Indonesia  
Tel: +62-21-520-2577

### KOREA

**Yamaha Music Korea Ltd.**  
11F, Prudential Tower, 298, Gangnam-daero,  
Gangnam-gu, Seoul, 06253, Korea  
Tel: +82-2-3467-3300

### MALAYSIA

**Yamaha Music (Malaysia) Sdn. Bhd.**  
No.8, Jalan Perbandaran, Kelana Jaya, 47301  
Petaling Jaya, Selangor, Malaysia  
Tel: +60-3-78030900

### SINGAPORE

**Yamaha Music (Asia) Private Limited**  
Block 202 Hougang Street 21, #02-00,  
Singapore 530202, Singapore  
Tel: +65-6740-9200

### TAIWAN

**Yamaha Music & Electronics Taiwan Co., Ltd.**  
2F., No.1, Yuanfong Rd., Banqiao Dist.,  
New Taipei City 22063, Taiwan (R.O.C.)  
Tel: +886-2-7741-8888

### THAILAND

**Siam Music Yamaha Co., Ltd.**  
3, 4, 15, 16th Fl., Siam Motors Building,  
891/1 Rama 1 Road, Wangmai,  
Pathumwan, Bangkok 10330, Thailand  
Tel: +66-2215-2622

### VIETNAM

**Yamaha Music Vietnam Company Limited**  
15th Floor, Nam A Bank Tower, 201-203 Cach  
Mang Thang Tam St., Ward 4, Dist.3,  
Ho Chi Minh City, Vietnam  
Tel: +84-28-3818-1122

### OTHER ASIAN REGIONS

[https://asia-latinamerica-mea.yamaha.com/  
index.html](https://asia-latinamerica-mea.yamaha.com/index.html)

## OCEANIA

### AUSTRALIA

**Yamaha Music Australia Pty. Ltd.**  
Level 1, 80 Market Street, South Melbourne,  
VIC 3205 Australia  
Tel: +61-3-9693-5111

### NEW ZEALAND

**Music Works LTD**  
P.O. BOX 6246 Wellesley, Auckland 4680,  
New Zealand  
Tel: +64-9-634-0099

### REGIONS AND TRUST TERRITORIES IN PACIFIC OCEAN

[https://asia-latinamerica-mea.yamaha.com/  
index.html](https://asia-latinamerica-mea.yamaha.com/index.html)

Yamaha Global Site  
<https://www.yamaha.com/>  
Yamaha Downloads  
<https://download.yamaha.com/>

Manual Development Group  
© 2019 Yamaha Corporation  
Published 06/2021  
POIN-C0

VAV7200