

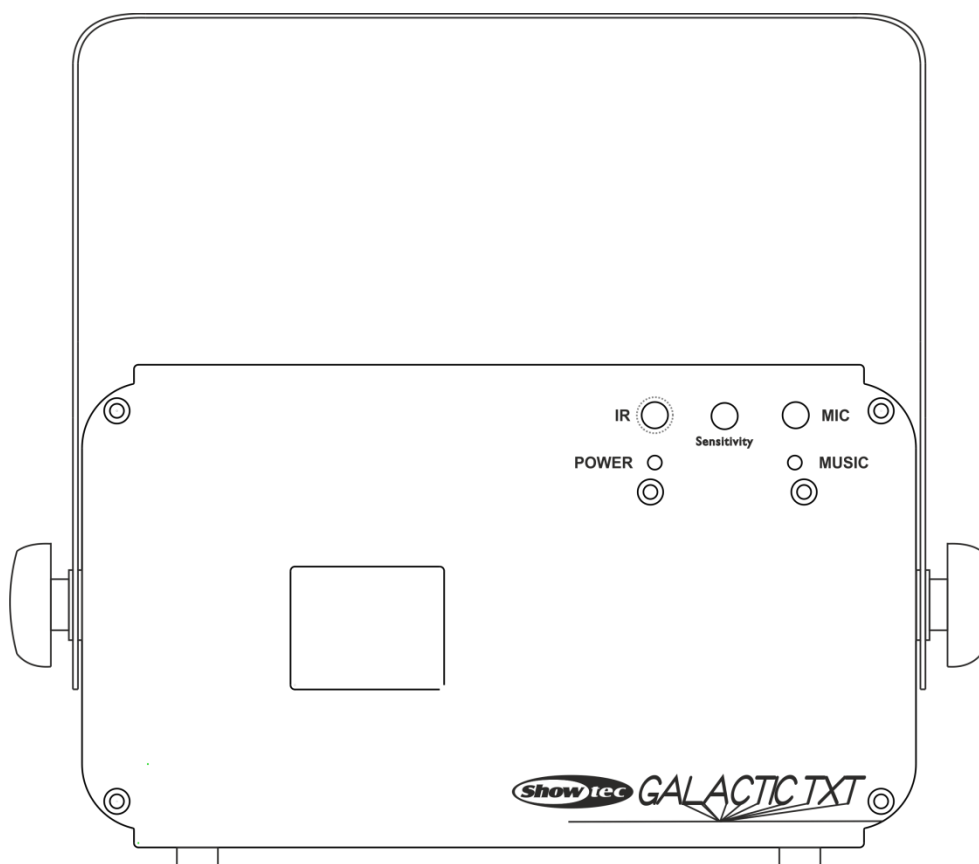

MANUAL



ENGLISH

Galactic TXT V1

Ordercode: 51342

Table of contents

Warning	3
Unpacking Instructions	3
Safety Instructions	4
Operating Determinations	5
Laser safety for a Class 3B Laser Product	6
Rigging	7
Connection with the mains	8
Return Procedure	9
Claims	9
Description of the device	10
Overview	10
Backside	11
Installation	11
Set Up and Operation	11
Control Modes	13
One Galactic (Stand-alone)	13
One Galactic (Sound-controlled)	13
Multiple Galactics (Master/Slave Mode)	13
Multiple Galactics (DMX Control)	14
Fixture Linking	15
Data Cabling	15
Control Panel	16
Control Mode	16
DMX Addressing	16
Menu Overview	17
Main Menu Options	18
1. Built-in Auto Shows	18
2. Sound-controlled Shows	18
3. Text Mode	18
4. Time Mode	18
5. Countdown Mode	19
6. Master/Slave Mode	19
7. DMX Mode	19
8. System Settings	20
Keyboard	21
1. Built-in Auto Shows	21
2. Sound-controlled Shows	21
3. Text Mode	22
4. Time Mode	24
5. Countdown Mode	25
6. Master/Slave Mode	25
7. DMX Mode	25
8. System Settings	26
Remote Control	27
1. Built-in Auto Shows	27
2. Sound-controlled Shows	27
3. Time Mode	28
4. Countdown Mode	28
5. Text Mode	28
DMX Channels	29
20 channels	29
Patterns	31

Maintenance32
 Replacing the Fuse32

Troubleshooting32
 No Light32
 No Response to DMX.....32

Product Specifications34

Dimensions35

Notes37

Warning



For your own safety, please read this user manual carefully
before your initial start-up!



Unpacking Instructions

Immediately upon receiving this product, carefully unpack the carton and check the contents to ensure that all parts are present, and have been received in good condition. Notify the dealer immediately and retain packing material for inspection if any parts appear damaged from shipping or the carton itself shows signs of mishandling. Save the carton and all packing materials. In the event that a fixture must be returned to the factory, it is important that the fixture be returned in the original factory box and packing.

Your shipment includes:

- Showtec Galactic TXT
- IEC power cable – 1,75 m
- Remote control plug and 2 interlock keys
- Remote control
- Keyboard
- User manual

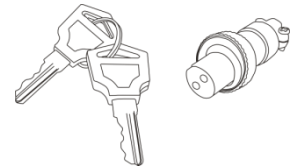
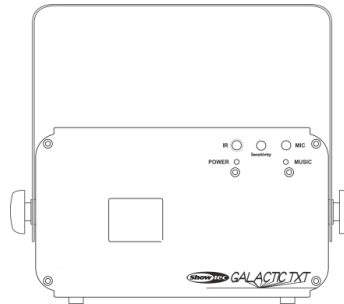

CAUTION – Class 3B LASER RADIATION WHEN OPEN AVOID DIRECT EXPOSURE TO BEAM



CAUTION! Eyedamages!!!
Never look directly into the lightsource!!!
Never project a single laser point!!!



CAUTION!
Keep this device away from rain and moisture!
Unplug mains lead before opening the housing!



Safety Instructions

Every person involved with the installation, operation and maintenance of this device has to:

- be qualified
- follow the instructions of this manual

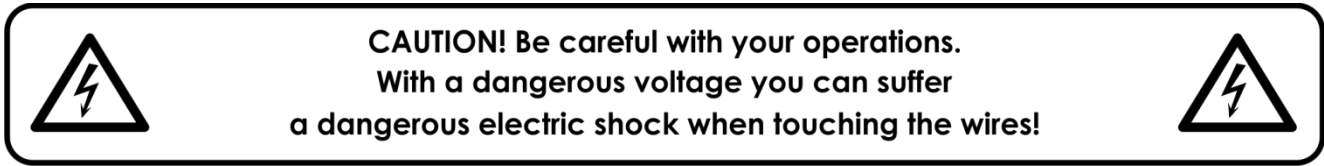

Before your initial start-up, please make sure that there is no damage caused by transportation. Should there be any, consult your dealer and do not use the device.

To maintain perfect condition and to ensure a safe operation, it is absolutely necessary for the user to follow the safety instructions and warning notes written in this manual.

Please consider that damages caused by manual modifications to the device are not subject to warranty.

This device contains no user-serviceable parts. Refer servicing to qualified technicians only.

IMPORTANT:

The manufacturer will not accept liability for any resulting damages caused by the non-observance of this manual or any unauthorized modification to the device.

- Never let the power cord come into contact with other cables! Handle the power cord and all connections with the mains with particular caution!
- Never remove warning or informative labels from the unit.
- Never use anything to cover the ground contact.
- Never place any material over the lens.
- Never look directly into the light source.
- Never leave any cables lying around.
- Never aim the laser beam at people or animals!
- Never use the device during thunderstorms, unplug the device immediately.
- Never point a laser at aircraft, this is a federal offense.
- Never point un-terminated laser beams into the sky.
- Never open the laser housing. The high laser power levels inside of the protective housing can start fires, burn skin and will cause instant eye injury.
- Do not insert objects into air vents.
- Do not connect this device to a dimmerpack.
- Do not open the device and do not modify the device.
- Do not point lasers at highly reflective surfaces such as windows, mirrors and shiny metal. Even laser reflections can be hazardous.
- Do not expose the output optic (aperture) to cleaning chemicals.
- Do not use laser if the laser appears to be emitting only one or two beams.
- Do not use laser if housing is damaged or open, or if optics appear damaged in any way.
- Do not operate laser without first reading and understanding all safety and technical data in this manual. Never look into the laser aperture or laser beams.
- Do not switch the device on and off in short intervals, as this would reduce the device's life.
- Do not shake the device. Avoid brute force when installing or operating the device.
- After set up and prior to public use, test laser to ensure proper function. Do not use the laser if any defect is detected. Do not use, if the laser emits only one or two laser beams rather than dozens/hundreds, as this could indicate damage to the diffraction grating optic, and could allow emission of higher laser levels.
- Only use device indoor, avoid contact with water or other liquids.
- Only operate the fixture after having checked that the housing is firmly closed and all screws are tightly fastened.
- Only operate the device after having familiarized with its functions.
- Avoid flames and do not put close to flammable liquids or gases.
- Always check the regulations when using a class IIIB laser product.

- Always check and position the laser before anybody enters the room, when the laser is facing an area with people.
- Always keep case closed while operating.
- Always allow free air space of at least 50 cm around the unit for ventilation.
- Always disconnect power from the mains, when device is not used or before cleaning! Only handle the power cord by the plug. Never pull out the plug by tugging the power cord.
- Make sure that the device is not exposed to extreme heat, moisture or dust.
- Make sure that the available voltage is not higher than stated on the rear panel.
- Make sure that the power cord is never crimped or damaged. Check the device and the power cord from time to time.
- If the external cable is damaged, it has to be replaced by a qualified technician.
- If the lens is obviously damaged, it has to be replaced. So that its functions are not impaired, due to cracks or deep scratches.
- If device is dropped or struck, disconnect mains power supply immediately. Have a qualified engineer inspect for safety before operating.
- If the device has been exposed to drastic temperature fluctuation (e.g. after transportation), do not switch it on immediately. The arising condensation water might damage your device. Leave the device switched off until it has reached room temperature.
- If your Showtec device fails to work properly, discontinue use immediately. Pack the unit securely (preferably in the original packing material), and return it to your Showtec dealer for service.
- For adult use only. Device must be installed out of the reach of children. Never leave the unit running unattended.
- Never attempt to bypass the thermostatic switch or fuses.
- For replacement use fuses of same type and rating only.
- The operation of a class 3B laser show laser is only allowed if the show is controlled by a skilled and well-trained operator familiar with the data included in this manual.
- The user is responsible for correct positioning and operating of the Galactic TXT. The manufacturer will not accept liability for damages caused by the misuse or incorrect installation of this device.
- This device falls under protection class I. Therefore it is essential to connect the yellow/green conductor to earth.
- The laser will only work between 15-35°C.
- After 3 hours working, you must shut off the laser and let the laser diode cool off for 30 minutes, otherwise the laser could be damaged and the warranty becomes void.
- Repairs, servicing and electric connection must be carried out by a qualified technician.
- WARRANTY: Till one year after date of purchase.



CAUTION! Eyedamages!!!
Avoid looking directly into the lightsource!!!
(meant especially for epileptics)!!!



Operating Determinations

- This device is not designed for permanent operation. Consistent operation breaks will ensure that the device will serve you for a long time without defects.
- The minimum distance between light-output and the illuminated surface must be more than 1 meter.
- The maximum ambient temperature $t_a = 35^\circ\text{C}$ must never be exceeded.
- The relative humidity must not exceed 50 % with an ambient temperature of 30°C .
- If this device is operated in any other way, than the one described in this manual, the product may suffer damages and the warranty becomes void.
- Any other operation may lead to dangers like short-circuit, burns, electric shock, crash etc.

You endanger your own safety and the safety of others!

Laser safety for a Class 3B Laser Product

Laser Light is different from any other light source with which you may be familiar with. The light from this product can potentially cause instant eye injury if not set up and used properly.

Laser light is thousands of times more concentrated than light from any other kind of light source. This concentration of light power can cause instant eye injuries, primarily by burning the retina (the light sensitive portion at the back of the eye). Even if you cannot feel "heat" from a laser beam, it can still potentially injure or blind you or your audience.

Even very small amounts of laser light are potentially hazardous even at long distances. Laser eye injuries can happen quicker than you can blink.

It is incorrect to think that because these laser products split the laser into hundreds of beams or the laser beam is scanned out in high speed, that an individual laser beam is safe for eye exposure. This laser product uses dozens of milliwatts of laser power (Class 3B levels internally). Many of the individual beams are potentially hazardous to the eyes.

It is also incorrect to assume that because the laser light is moving, it is safe. This is not true. Nor, do the laser beams always move. Since eye injuries can occur instantly, it is critical to prevent the possibility of any direct eye exposure. According to the laser safety regulation, it is not legal to aim Class 3B lasers in areas which people can get exposed. This is true even if it is aimed below people's faces, such as on a dance floor.

CAUTION! Only Laser Safety Officers who are officially certified by a regulatory body or authorized training organization are allowed to use class 3B lasers in public. The Laser Safety Officer is responsible for all aspects when using this laser, including following all locally applicable safety laws and regulations. The manufacturer will not accept liability for damages caused by the misuse or incorrect installation of this laser.



CAUTION: AVOID EXPOSURE TO BEAM: Avoid direct eye contact with laser light. Never intentionally expose your eyes or others to direct laser radiation.

Compliance Statement

Your Galactic Laser has been designed to comply with FDA and IEC Standards for its classification. The Galactic is a Class 3B laser product.

Laser Safety and Compliance Information

The Galactic is manufactured to comply with the IEC 60825-1 and in accordance with U.S. Food and Drug Administration (FDA) Standards Listed under FDA Document 21 CFR 1040 and subsequent laser notices.

Product Classification and Manufacturing Label Identification

Laser Classification	Class 3B
Cooling	TE Cooling and Cooling fan
Laser medium	wavelength 450 nm / Blue (DPSS), 70mW
	wavelength 532 nm / Green (DPSS), 40mW
	wavelength 650 nm / Red (Laser Diode), 105mW
Output	215 mW
Beam Diameter	<20mm at aperture
Pulse Data All pulses	< 4Hz (>0.25sec)
Divergence (each beam)	<2 mrad
Divergence (total light)	<160 degrees

The legal requirements for using laser entertainment products vary from country to country. The user is responsible for the legal requirements at the location/country of use.

Further guidelines and safety programs for safe use of lasers can be found in the ANSI Z136.1 Standard "For Safe Use of Lasers", available from www.laserinstitute.org. Many local governments, corporations,

agencies, military and others, require all lasers to be used under the guidelines of ANSI Z136.1. Laser Display guidance can be obtained via the International Laser Display Association, www.laserist.org.

CAUTION: The use of corrective eye wear or optics for viewing at distances such as telescopes or binoculars within a distance of 100mm may pose an eye hazard.



This laser product is a Class 3B laser and has an Interlocked housing.



There are no user serviceable parts inside. Tampering or removing warranty seals will void your products limited warranty.



Combo label with the Product Model Number, Serial Number, Date of Manufacturing, Laser Light Warning Label, Warranty Void Label and Interlocked Housing Label

Proper Usage Safety and Compliance Information

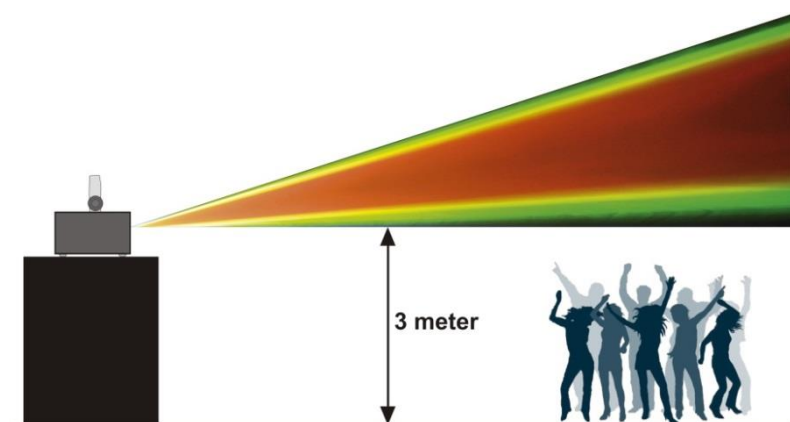

According to FDA Regulations you should operate this product as stated on the left.

Rigging

Please follow the European and national guidelines concerning rigging, trussing and all other safety issues.

Do not attempt the installation yourself !

Always let the installation be carried out by an authorized dealer !

Procedure:

- If the Galactic is lowered from the ceiling or high joists, professional trussing systems have to be used.
- Use a clamp to mount the Galactic, with the mounting-bracket, to the trussing system.
- The Galactic must never be fixed swinging freely in the room.
- The installation must always be secured with a safety attachment, e.g. an appropriate safety net or safety-cable.
- When rigging, derigging or servicing the Galactic, always make sure, that the area below the installation place is blocked and staying in the area is forbidden.

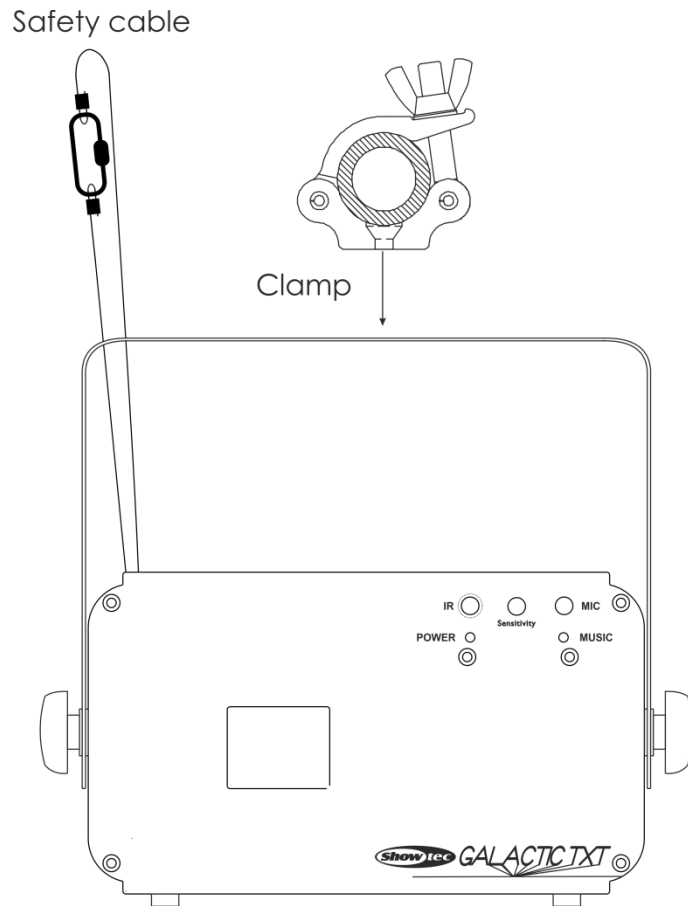

The Galactic can be placed on a flat stage floor or mounted to any kind of truss with a clamp.

Improper installation can cause serious damage to people and property !

Connection with the mains

Connect the device to the mains with the power-plug.

Always pay attention, that the right color cable is connected to the right place.

International	EU Cable	UK Cable	US Cable	Pin
L	BROWN	RED	YELLOW/COPPER	PHASE
N	BLUE	BLACK	SILVER	NEUTRAL
	YELLOW/GREEN	GREEN	GREEN	PROTECTIVE GROUND

Make sure that the device is always connected properly to the earth!

Improper installation can cause serious damage to people and property!





Return Procedure



Returned merchandise must be sent prepaid and in the original packing, call tags will not be issued. Package must be clearly labeled with a Return Authorization Number (RMA number). Products returned without an RMA number will be refused. Highlite will not accept the returned goods or any responsibility. Call Highlite 0031-455667723 or mail aftersales@highlite.nl and request an RMA prior to shipping the fixture. Be prepared to provide the model number, serial number and a brief description of the cause for the return. Be sure to properly pack fixture, any shipping damage resulting from inadequate packaging is the customer's responsibility. Highlite reserves the right to use its own discretion to repair or replace product(s). As a suggestion, proper UPS packing or double-boxing is always a safe method to use.

Note: If you are given an RMA number, please include the following information on a piece of paper inside the box:

- 01) Your name
- 02) Your address
- 03) Your phone number
- 04) A brief description of the symptoms

Claims

The client has the obligation to check the delivered goods immediately upon delivery for any shortcomings and/or visible defects, or perform this check after our announcement that the goods are at their disposal. Damage incurred in shipping is the responsibility of the shipper; therefore the damage must be reported to the carrier upon receipt of merchandise.

It is the customer's responsibility to notify and submit claims with the shipper in the event that a fixture is damaged due to shipping. Transportation damage has to be reported to us within one day after receipt of the delivery.

Any return shipment has to be made post-paid at all times. Return shipments must be accompanied with a letter defining the reason for return shipment. Non-prepaid return shipments will be refused, unless otherwise agreed in writing.

Complaints against us must be made known in writing or by fax within 10 working days after receipt of the invoice. After this period complaints will not be handled anymore.

Complaints will only then be considered if the client has so far complied with all parts of the agreement, regardless of the agreement of which the obligation is resulting.

Description of the device

Features

The Showtec Galactic TXT is a laser effect with high output and great effects.

- Power Input: AC 100-240V, 60/50Hz
- Power Consumption: 12 Watt
- Beam Diameter <20mm at aperture
- Laser Class: 3B
- Laser Modulation: TTL
- Laser Safety: EN/IEC 60825-1 Ed 2, 2007-03
- Laser Color: Red, Green, Yellow, Blue, Purple, Cyan, White
- Laser Power: 215mW (105mW 650nm Red, 40mW 532nm Green, 70mW 450nm Blue)
- Scan Angle: +/-80°
- Control Modes: Auto, Sound, Text, Time, Countdown, DMX, Master/Slave
- Divergence (each beam) <2 mrad; Divergence (total light) <160 degrees
- 3-pin DMX In and 3-pin DMX Out
- LED Display
- Compact strong metal housing
- Sound-controlled via built-in microphone
- 20 DMX Channels
- Safety Features: Key switch, Interlock
- Fuse T1A/250V
- Dimensions: 225 x 185 x 185 mm (LxWxH)
- Weight: 2 kg
- Accessories: 2 Keys, Interlock remote plug, remote control, keyboard

Overview

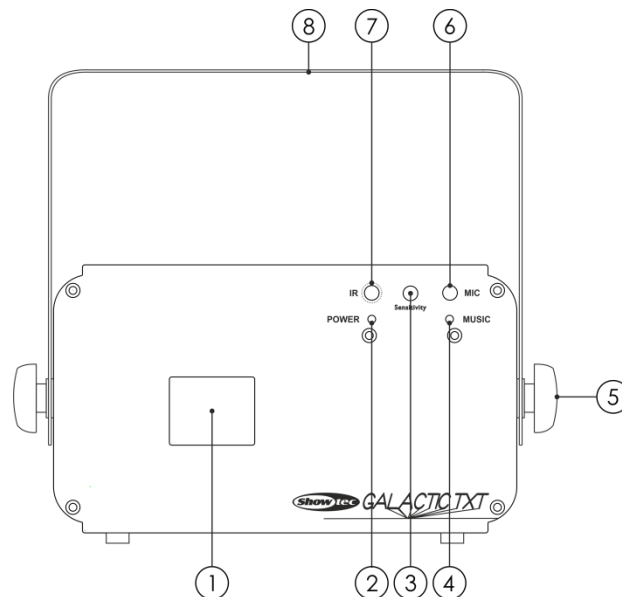

Fig. 01

- 01) Lens
- 02) LED power indicator
- 03) Sound sensitivity control
- 04) LED sound control indicator
- 05) Adjustment screw
- 06) Built-in microphone
- 07) Remote control LED indicator
- 08) Mounting bracket with inclined screw

Backside

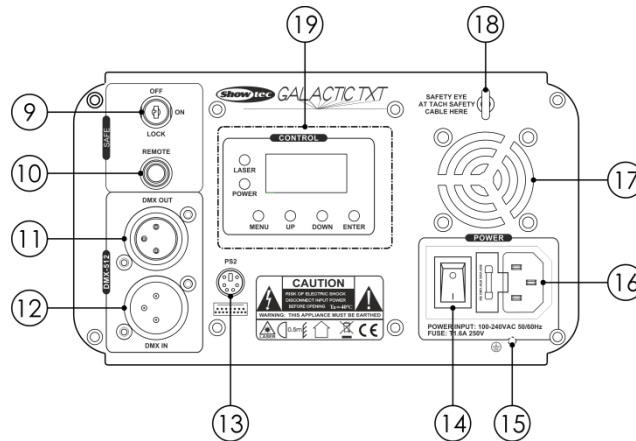

Fig. 02

- 09) Interlock
- 10) Remote control plug
- 11) 3-pin DMX signal connector OUT
- 12) 3-pin DMX signal connector IN
- 13) PS/2 keyboard connector
- 14) Power switch ON/OFF
- 15) Ground/Earth connection
- 16) IEC power connector 100-240VAC + Fuse T1A/250V
- 17) Cooling fan
- 18) Safety eye
- 19) LED display + control buttons + LED indicators

Installation

Remove all packing materials from the Galactic. Check if all foam and plastic padding is removed. Connect all cables.

Do not supply power before the whole system is set up and connected properly.

Always disconnect from electric mains power supply before cleaning or servicing.

Damages caused by non-observance are not subject to warranty.

Set Up and Operation

Follow the directions below, as they pertain to your preferred operation mode.

Before plugging the unit in, always make sure that the power supply matches the product specification voltage. Do not attempt to operate a 120V specification product on 230V power, or vice versa.

Connect the device to the main power supply. The device can be sound-controlled as it is equipped with a built-in microphone.

The Interlock plug/remote plug and safety keys are included in the box.
The interlock is the "included-in-the-box" successor for the optional remote interlock (51316)

⚠ They should be kept with the Galactic laser !!! ⚠

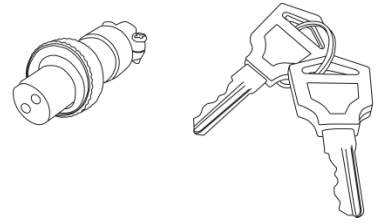

The following safety precautions should be followed:

- The remote control plug should be placed on the backside **(10)** of your Galactic laser.
- The keys should be put into the lock **(09)** of your Galactic laser.

⚠ Warning ⚠

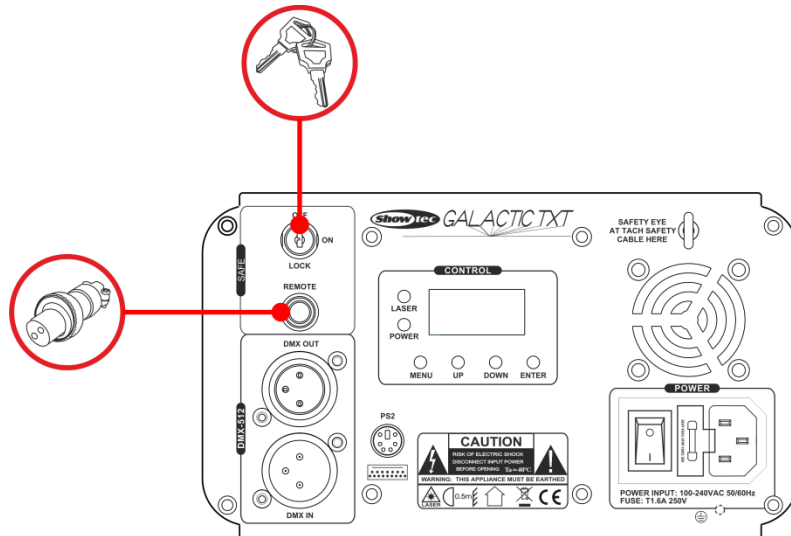

Exclusion of liability

Be aware that in some countries, there are additional regulations, regarding the use of laser devices. Therefore, we strongly advise you to verify your national laws with your authorities: We do not take any responsibility for eventual discrepancies, changes or adaptations regarding lawful use of laser devices.

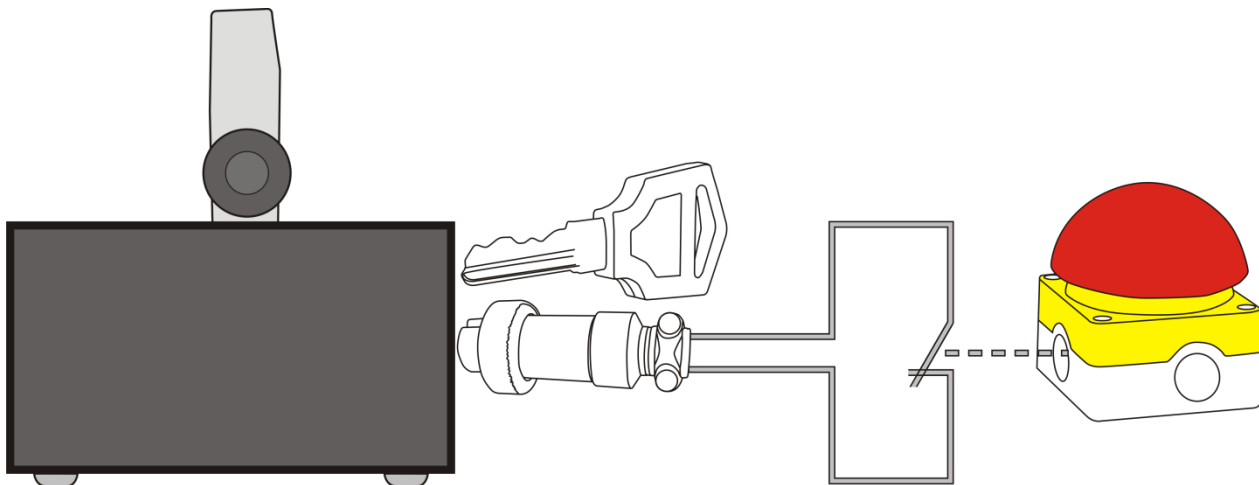

Control Modes

There are 7 modes:

- Built-in programs (stand-alone)
- Sound-controlled
- Text mode, page 18
- Time Mode, page 18
- Countdown mode, page 19
- Master/Slave
- DMX-512 (20CH)

One Galactic (Stand-alone)

- 01) Fasten the effect light onto firm trussing. Leave at least 0,5 meter on all sides for air circulation.
- 02) Always use a safety cable (ordercode 70140 / 70141).
- 03) Plug the end of the electric mains power cord into a proper electric power supply socket.
- 04) When the Galactic is not connected by a DMX-cable, it functions as a stand-alone device.
- 05) Please see page 18 for more information about the Built-in auto programs.

One Galactic (Sound-controlled)

- 01) Fasten the effect light onto firm trussing. Leave at least 0,5 meter on all sides for air circulation.
- 02) Always use a safety cable (ordercode 70140 / 70141).
- 03) Plug the end of the electric mains power cord into a proper electric power supply socket.
- 04) When the Galactic is not connected with a DMX-cable, it functions as a stand-alone device.
- 05) Please see page 18 for more information about the Sound-controlled mode.

Multiple Galactics (Master/Slave Mode)

- 01) Fasten the effect light onto firm trussing. Leave at least 0,5 meter on all sides for air circulation.
- 02) Always use a safety cable (ordercode 70140 / 70141).
- 03) Plug the end of the electric mains power cord into a proper electric power supply socket.
- 04) Use a 3-pin XLR cable to connect the Galactics.

The pins:



- 01) Earth
- 02) Signal (-)
- 03) Signal (+)

- 05) Link the units as shown in Fig. 03, connect a DMX signal cable from the first unit's DMX "out" socket to the second unit's "in" socket. Repeat this process to link the second, third, and fourth units. You can use the same functions on the master device as described on page 18 (Built-in or Sound-controlled). This means on the master device you can set your desired operation mode and all slave devices will react the same as the master device.

Multiple Galactics Master/Slave Set Up

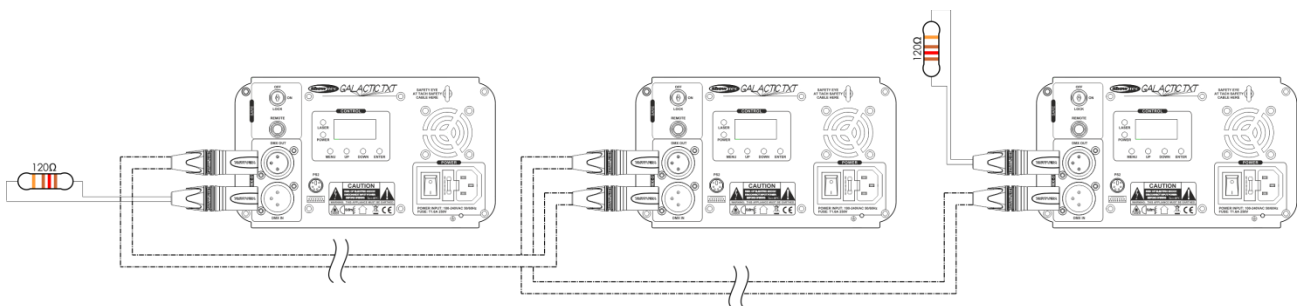
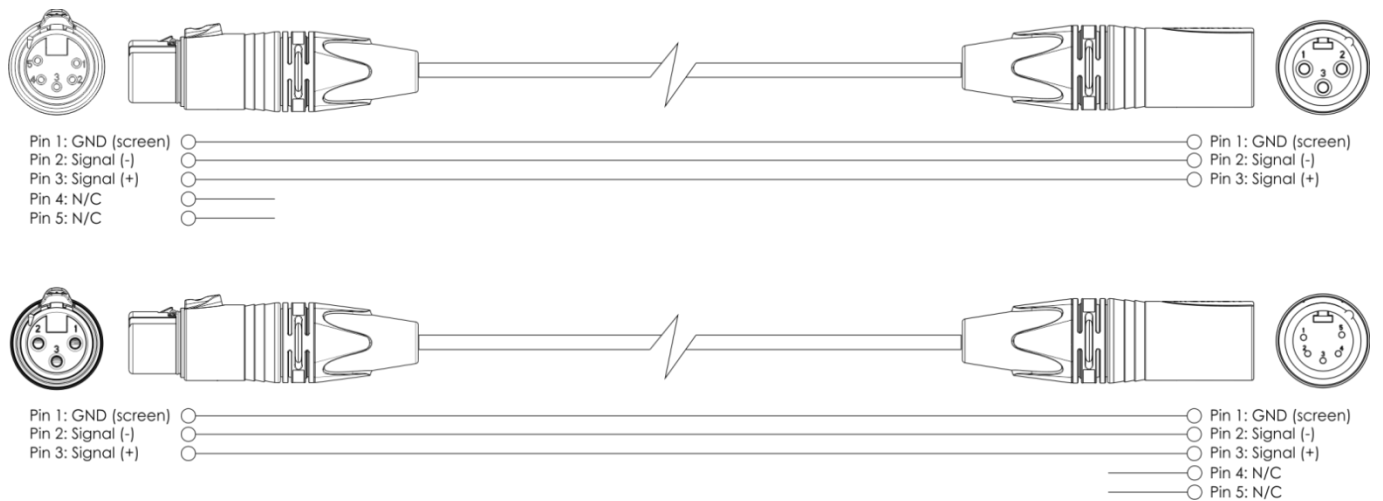

Fig. 03

Multiple Galactics (DMX Control)

- 01) Fasten the effect light onto firm trussing. Leave at least 1 meter on all sides for air circulation.
- 02) Always use a safety cable (ordercode 70140 / 70141).
- 03) Plug the end of the electric mains power cord into a proper electric power supply socket.
- 04) Use a 3-p XLR cable to connect the Galactics and other devices.



- 05) Link the units as shown in Fig. 04, Connect a DMX signal cable from the first unit's DMX "out" socket to the second unit's "in" socket. Repeat this process to link the second, third, and fourth units.
- 06) Supply electric power: Plug electric mains power cords into each unit's IEC socket, then plug the other end of the mains power cord into proper electric power supply sockets, starting with the first unit. Do not supply power before the whole system is set up and connected properly.

Multiple Galactics DMX Set Up

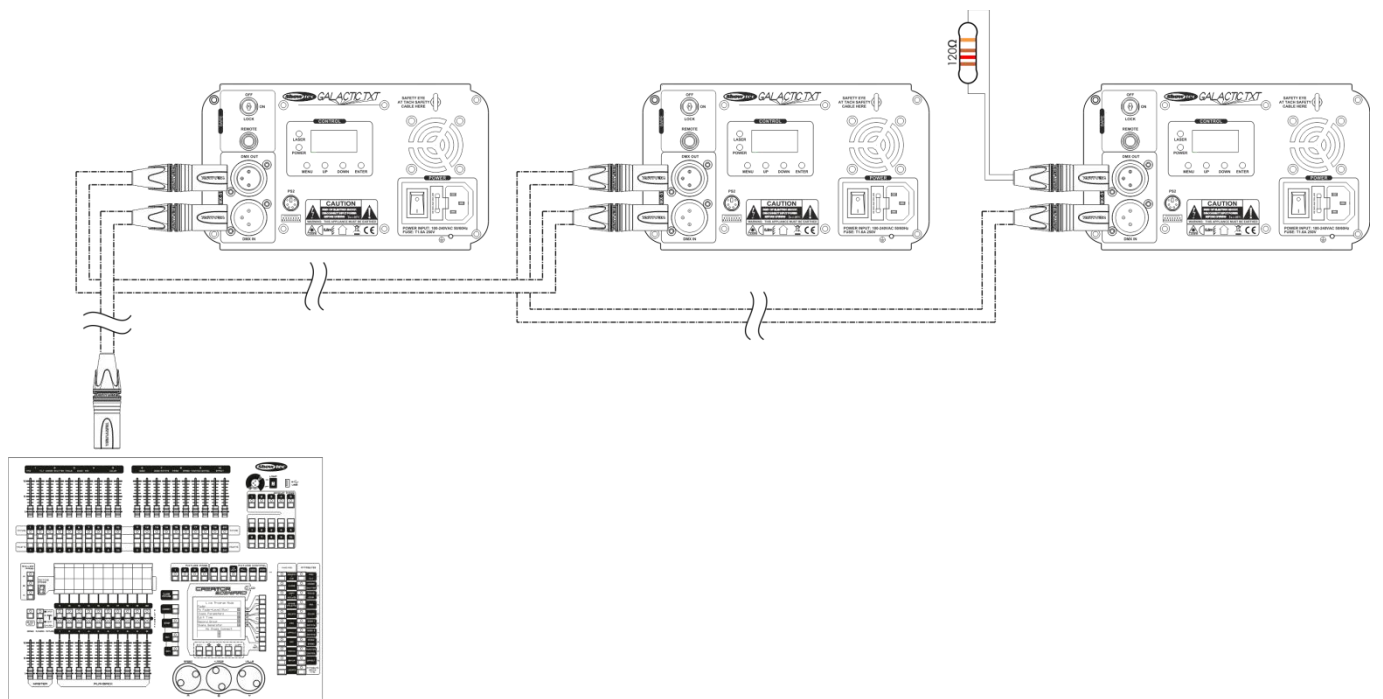

Fig. 04

Note: Link all cables before connecting electric power

Fixture Linking

You will need a serial data link to run light shows of one or more fixtures using a DMX-512 controller or to run synchronized shows on two or more fixtures set to a master/slave operating mode. The combined number of channels required by all the fixtures on a serial data link determines the number of fixtures the data link can support.

Important: Fixtures on a serial data link must be daisy chained in one single line. To comply with the EIA-485 standard no more than 30 devices should be connected on one data link. Connecting more than 30 fixtures on one serial data link without the use of a DMX optically isolated splitter may result in deterioration of the digital DMX signal.



Maximum recommended DMX data link distance: 100 meters

Maximum recommended number of fixtures on a DMX data link: 30 fixtures

Data Cabling

To link fixtures together, you must obtain data cables. You can purchase DAP Audio certified DMX cables directly from a dealer/distributor or construct your own cable. If you choose to create your own cable please use data-grade cables that can carry a high quality signal and are less prone to electromagnetic interference.

DAP Audio Certified DMX Data Cables

- DAP Audio cable for all-round use. bal. XLR/M 3 p. > XLR/F 3 p.
Ordercode FL01150 (1,5m.), FL013 (3m.), FL016 (6m.), FL0110 (10m.), FL0115 (15m.), FL0120 (20m.).
- DAP Audio cable for the demanding user with exceptional audio-qualities and connector made by Neutrik®. Ordercode FL71150 (1,5m.), FL713 (3m.), FL716 (6m.), FL7110 (10m.).

The Galactic can be operated with a controller in **control mode** or without the controller in **stand-alone mode**.

Control Panel

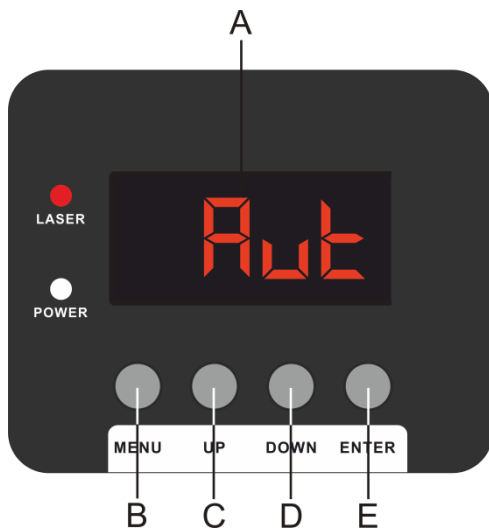

- A) LED display
- B) MENU button
- C) UP button
- D) DOWN button
- E) ENTER button

Fig. 05

Control Mode

The fixtures are individually addressed on a data-link and connected to the controller. The fixtures respond to the DMX signal from the controller. (When you select the DMX address and save it, the controller will display the saved DMX address the next time.)

DMX Addressing

The control panel on the front side of the base allows you to assign the DMX fixture address, which is the first channel from which the Galactic will respond to the controller.

Please note when you use the controller, the unit has **20** channels.

When using multiple Galactics, make sure you set the DMX addresses right.

Therefore, the DMX address of the first Galactics should be **1(001)**; the DMX address of the second Galactic should be **1+20=21 (021)**; the DMX address of the third Galactic should be **21+20=41 (041)**, etc. Please, make sure that you do not have any overlapping channels in order to control each Galactic correctly.

If two or more Galactics are addressed similarly, they will work similarly.

Controlling:

After having addressed all Galactic fixtures, you may now start operating these via your lighting controller.

Note: After switching on, the Galactic will automatically detect whether DMX-512 data is received or not. If there is no data received at the DMX-input, the "**LED**" on the control panel will not flash.

The problem may be:

- The XLR cable from the controller is not connected with the input of the Galactic.
- The controller is switched off or defective, the cable or connector is defective, or the signal wires are swapped in the input connector.

Note: It is necessary to insert an XLR termination plug (with 120 Ohm) in the last fixture in order to ensure proper transmission on the DMX data link.

Menu Overview

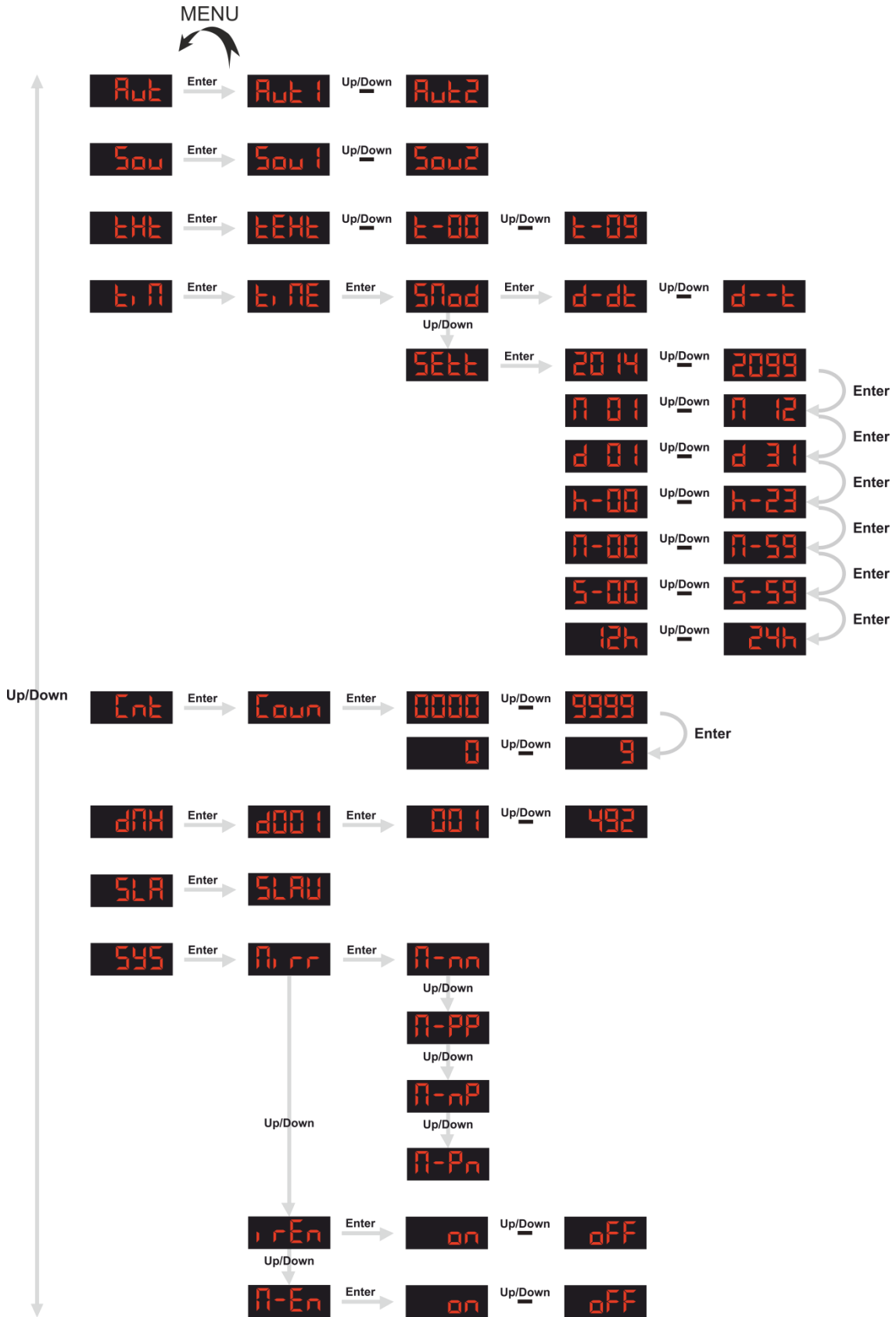

Main Menu Options

Aut	Built-in Auto Shows
Sou	Sound-controlled Shows
txt	Text Mode
t, n	Time Mode
Cnt	Countdown Mode
dmx	DMX-512 Mode
SLA	Master/Slave Mode
SYS	System Settings

 **Before using the control modes, it is highly advised to get acquainted with the chapter on keyboard operations, page 21** 

1. Built-in Auto Shows

- 01) While in the main menu, press the **UP** and **DOWN** buttons until the display shows **Aut** and press the **ENTER** button.
- 02) Press **UP** and **DOWN** buttons to choose from two built-in auto shows: **Aut1** ^{Up/Down} **Aut2**.
- 03) The device will now run the automatic, built-in show.

2. Sound-controlled Shows

- 01) While in the main menu, press the **UP** and **DOWN** buttons until the display shows **Sou** and press the **ENTER** button.
- 02) Press **UP** and **DOWN** buttons to choose from two sound-controlled shows: **Sou1** ^{Up/Down} **Sou2**.
- 03) The device will now run the automatic, built-in, sound-controlled show.

3. Text Mode

In this menu you can choose the text which is going to be displayed.

- 01) While in the main menu, press the **UP** and **DOWN** buttons until the display shows **txt** and press the **ENTER** button. The display will show **txt**.
- 02) Press the **UP** and **DOWN** buttons to toggle between **t-00** ^{Up/Down} **t-09**. Each number corresponds with a single user-made text.
- 03) The device will now display the desired text.

Note: To be able to use Text Mode to the full extent, use the included keyboard and get acquainted with the keyboard operations, see page 21.

4. Time Mode

- 01) While in the main menu, press the **UP** and **DOWN** buttons until the display shows **t, n**.
- 02) Press the **ENTER** button to confirm. The display will show **t, n**.
- 03) Press the **ENTER** button again. The display will show **SMOD**. Press the **ENTER** button to enter time display mode. Press the **UP** and **DOWN** buttons to choose one of the two options:

d-tt	Day and Time
d--t	Only Time



- 04) While the display shows **5Mod**, press the **UP** and **DOWN** buttons. The display will show **SEtE**.
- 05) Press the **ENTER** button to enter time display settings.
- 06) There are several adjustable time display parameters. Press the **ENTER** button to toggle between:

	Up/Down		Year
	Up/Down		Month
	Up/Down		Day
	Up/Down		Hour
	Up/Down		Minutes
	Up/Down		Seconds
	Up/Down		12- or 24-hour Display Mode

- 07) Meanwhile, press the **UP** and **DOWN** buttons to adjust the values of the forementioned parameters.

5. Countdown Mode

In this menu you can activate a time countdown.

- 01) While in the main menu, press the **UP** and **DOWN** buttons until the display shows **Cnt**.
- 02) Press the **ENTER** button, the display will show **Count**.
- 03) Press the **ENTER** button again. Press the **UP** and **DOWN** buttons to set the starting point of the countdown. The adjustment range is between  Up/Down .
- 04) Once the starting point has been set up, press the **ENTER** button again.
- 05) Press the **UP** and **DOWN** buttons to choose the text which will be displayed once the countdown time has run up.

The adjustment range is between  Up/Down .

Each number corresponds with the user-made texts.



- 06) Press the **ENTER** button to link the countdown to the desired text.
- 07) Press the **UP** and **DOWN** buttons to start the countdown.
- 08) If you want to pause the countdown, press the **UP** and **DOWN** buttons again.
- 09) Similarly, press the **UP** and **DOWN** buttons to resume the countdown.

6. Master/Slave Mode

In this menu you can set the fixture as a slave device.















- 01) While in the main menu, press the **UP** and **DOWN** buttons until the display shows **SLA**.
- 02) Press the **ENTER** button, the display will show **SLAVE**.
- 03) The device is now operating in slave mode. It means that it will react the same as the master device.

7. DMX Mode

- 01) While in the main menu, press the **UP** and **DOWN** buttons until the display shows **dmx**.
- 02) Press the **ENTER** button. The display will show **0001**.
- 03) Press the **UP** and **DOWN** buttons to set the desired DMX address between  Up/Down .
- 04) Press the **ENTER** button to confirm.

8. System Settings

In this menu you can adjust the show display settings.

- 01) While in the main menu, press the **UP** and **DOWN** buttons until the display shows .
- 02) Press the **ENTER** button to enter the display options edition.
- 03) Press the **UP** and **DOWN** buttons to choose one of the 3 possibilities:
 -  Show Mirror Mode
 -  Remote Control Mode
 -  Master Mode
- 04) While the display shows , press the **ENTER** button to proceed to the show display mirror options.
- 05) Press the **UP** and **DOWN** buttons to choose one of the 4 possibilities:
 -  Normal View
 -  Horizontal + Vertical Flip
 -  Horizontal Flip
 -  Vertical Flip
- 06) While the display shows , press the **ENTER** button to proceed to the remote control settings.
- 07) Press the **UP** and **DOWN** buttons to choose between  ^{Up/Down} .
 - If set to ON, the fixture will recognize the included remote control.
 - If set to OFF, the remote control will be ignored by the fixture.
- 08) While the display shows , press the **ENTER** button to proceed to master settings.
- 09) Press the **UP** and **DOWN** buttons to choose between  ^{Up/Down} .
 - If set to ON, the device is operating as a master device.
 - If set to OFF, the device is no longer perceived as a master device.



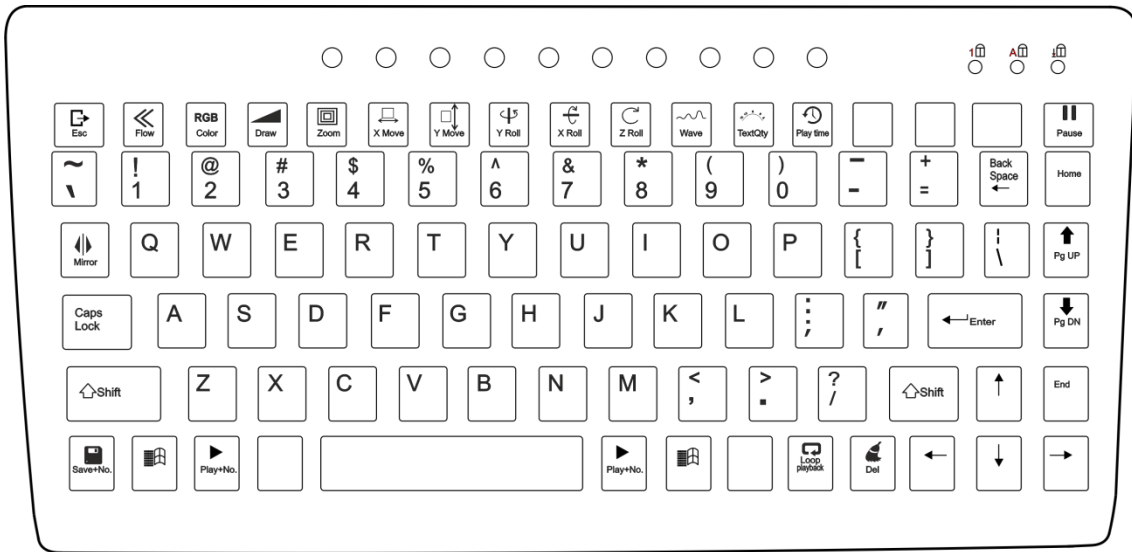

Keyboard

It is possible to operate the device by means of the included keyboard.





The keyboard should be plugged into the PS/2 keyboard connector **(13)** on the backside of the device.



1. Built-in Auto Shows



- 01) Press the  key to proceed to the main menu.
- 02) Press the **UP** and **DOWN** cursors until the display shows .
- 03) Press the **ENTER** key to proceed.
- 04) Press the **UP** and **DOWN** cursors to choose from two built-in auto shows:  ^{Up/Down} .
- 05) The device will now run the automatic, built-in show.

2. Sound-controlled Shows

- 01) Press the  key to proceed to the main menu.
- 02) Press the **UP** and **DOWN** cursors until the display shows  and press the **ENTER** key.
- 03) Press the **UP** and **DOWN** cursors to choose from two sound-controlled shows:  ^{Up/Down} .
- 04) The device will now run the automatic, built-in, sound-controlled show.

3. Text Mode

In this menu you can create and edit custom texts which can be displayed during a show.

- 01) Press the  key to proceed to the main menu.
- 02) Press the **UP** and **DOWN** cursors until the display shows .
- 03) Press the **ENTER** key to proceed to edition mode.
- 04) Type in your custom text.
- 05) Press the following keys to adjust the characteristics of your text:

Note: The keys below should be pressed repeatedly. Each press of the buttons corresponds with a different function. Pressing the **UP** and **DOWN** cursors will adjust the speed of action, unless stated otherwise.

Key

Action



Flow settings

Flow OFF
Flow ON



Color settings

Manual adjustment

Press the **UP** and **DOWN** cursors to manually choose one of the available colors: Red, Green, Blue, Yellow, Purple, Cyan, White.

Color switch

Press the **UP** and **DOWN** cursors to adjust the switch speed.

Color flow

Press the **UP** and **DOWN** cursors to adjust the flow speed.



Pattern drawing settings

Drawing OFF
Drawing ON



Zoom settings

Zoom out
Zoom in
Zoom in and out
Zoom OFF



Horizontal movement settings

From left to right
From right to left
Movement OFF



Vertical movement settings

Vertical movement
Vertical movement + up/down movement
Vertical movement OFF

**Y-axis rotation settings**

Counterclockwise rotation
 Clockwise rotation
 Rotation OFF

**X-axis rotation settings**

Clockwise rotation
 Counterclockwise rotation
 Rotation OFF

**Z-axis rotation settings**

Clockwise rotation
 Counterclockwise rotation
 Rotation OFF

**Wave effect settings**

Wave range
 Wave frequency
 Wave speed

Press the **UP** and **DOWN** cursors to adjust the intensity of each of those parameters.

**Character display settings**

12 characters
 10 characters
 8 characters
 6 characters
 4 characters

Press the **UP** and **DOWN** cursors to adjust the number of the displayed characters.

**Play time settings**

Press the numeric keys 0-9 to set the duration of a single text playback.
 For example, 0008 = 8 seconds.

**Delete**

Press the key to delete the whole text, along with its all characteristics.

**Backspace**

Press the key to remove one character.

**Home**

Press the key to set the cursor in front of the initial character.

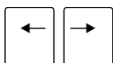

**End**

Press the key to set the cursor behind the final character.

**LEFT and RIGHT cursors**

Press the key to move back and forth in your text.



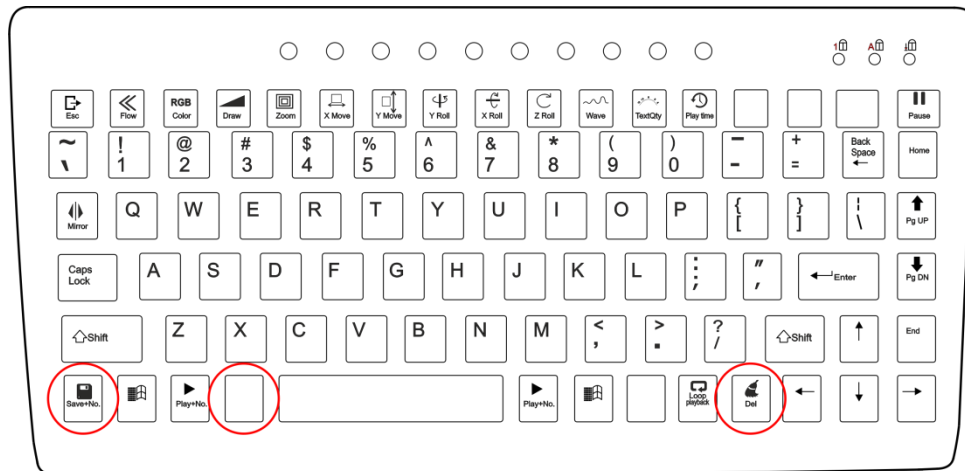

- 06) To save your custom text with all its characteristics, press the key combination of  key, and the **numeric keys, 0-9**. Always save your texts starting with 0, then 1,2, etc. If 0-slot remains empty, the loop playback mode **will not** function.
- 07) Repeat the steps 1-6 as many times as needed.

- 08) To display all the texts one-by-one, press the  key. All the saved texts will now be displayed in a sequence.
- 09) Press the **PgUP** and **PgDN** keys to toggle manually between your saved texts.
- 10) To call up one particular text, press the key combination of  key and the **numeric keys, 0-9**.
- 11) To delete all the texts in order to create new ones, press the following key combination:





- 12) All the texts have now been deleted.
- 13) To create new texts, repeat all the steps 1-10.

4. Time Mode

- 01) Press the  key to proceed to the main menu.
- 02) While in the main menu, press the **UP** and **DOWN** cursors until the display shows .
- 03) Press the **ENTER** key to confirm. The display will show .
- 04) Press the **ENTER** key again. The display will show . Press the **ENTER** key to enter time display mode. Press **UP** and **DOWN** cursors to choose one of the two options:

 Day and Time

 Only Time

- 05) While the display shows , press the **UP** and **DOWN** cursors. The display will show .
- 06) Press the **ENTER** key to enter time display settings.
- 07) There are several adjustable time display aspects. Press the **ENTER** key to toggle between:

   Year

   Month

   Day

   Hour

   Minutes

   Seconds

   12- or 24-hour Display Mode

- 08) To change the values of the forementioned parameters, press the **UP** and **DOWN** cursors.
- 09) If you need to flip the time display, press repeatedly the  key and choose one of the 4 available options:



Normal View



Horizontal + Vertical Flip









Horizontal Flip



Vertical Flip



5. Countdown Mode

In this menu you can activate a time countdown.





- 01) Press the  key to proceed to the main menu.
- 02) While in the main menu, press the **UP** and **DOWN** cursors until the display shows .
- 03) Press the **ENTER** key, the display will show .
- 04) Press the **ENTER** key again. Press the **UP** and **DOWN** cursors to set the starting point of the countdown. The adjustment range is between  ^{Up/Down}  seconds.
- 05) Once the starting point has been set up, press the **ENTER** key again.
- 06) Press the **UP** and **DOWN** cursors to choose the text which will be displayed once the countdown time has run up. The adjustment range is between  ^{Up/Down} . Each number corresponds with the user-made texts.
- 07) Press the **ENTER** key to confirm.
- 08) Press the **SPACE** key to start the countdown.
- 09) If you want to pause the countdown, press the **SPACE** key again.
- 10) Similarly, press the **SPACE** key to resume the countdown.

6. Master/Slave Mode

In this menu you can set the fixture as a slave device.



- 01) Press the  key to proceed to the main menu.
- 02) While in the main menu, press the **UP** and **DOWN** keys until the display shows .
- 03) Press the **ENTER** key. The display will show .
- 04) The device is now operating in slave mode. It means that it will react the same as the master device.





7. DMX Mode











- 01) Press the  key to proceed to the main menu.
- 02) While in the main menu, press the **UP** and **DOWN** cursors until the display shows .
- 03) Press the **ENTER** key. The display will show .
- 04) Press the **UP** and **DOWN** cursors to set the desired DMX address between  ^{Up/Down} .
- 05) Press the **ENTER** key to set the address.

8. System Settings

In this menu you can adjust the show display settings of the device.

- 01) Press the  key to proceed to the main menu.
- 02) While in the main menu, press the **UP** and **DOWN** cursors until the display shows .
- 03) Press the **ENTER** key to enter the display options edition.
- 04) Press the **UP** and **DOWN** cursors to choose one of the 3 possibilities:

	Show Mirror Mode
	Remote Control Mode
	Master Mode
- 05) While the display shows , press the **RIGHT** cursor to proceed to the show display mirror options.
- 06) Press the **UP** and **DOWN** cursors to choose one of the 4 possibilities:

	Normal View
	Horizontal + Vertical Flip
	Horizontal Flip
	Vertical Flip
- 07) While the display shows , press the **RIGHT** cursor to proceed to the remote control settings.
- 08) Press the **UP** and **DOWN** cursors to choose between  ^{Up/Down} .
If set to ON, the fixture will recognize the included remote control.
If set to OFF, the remote control will be ignored by the fixture.
- 09) While the display shows , press the **ENTER** key to proceed to master settings.
- 10) Press the **UP** and **DOWN** cursors to choose between  ^{Up/Down} .
If set to ON, the device is operating as a master device.
If set to OFF, the device is no longer perceived as a master device.

Remote Control

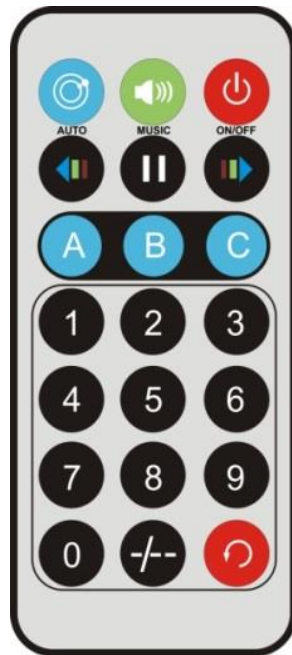

Button	Function	Description
	On / Off	Switch the device ON or OFF
	Auto Mode	Activate Built-in Auto Shows mode
	Sound-controlled Mode	Activate Sound-controlled mode
	Time Mode	Activate Time mode
	Countdown Mode	Activate Countdown mode
	Text Mode	Activate Text Mode
	Mirror	Set the display flip mode
	Pause	Play/pause the show
	Adjustment	Adjust the parameters

1. Built-in Auto Shows

- 01) Press the button to activate Built-in Auto Shows mode.
- 02) Press the button repeatedly to toggle between the two shows: ^{Up/Down} .
- 03) Press the button to pause the show. If no other button is pressed afterwards, the show will resume after 5 seconds.

2. Sound-controlled Shows

- 01) Press the button to activate Sound-controlled mode.
- 02) Press the button repeatedly to toggle between the two shows: ^{Up/Down} .
- 03) Press the button to pause the show. If no other button is pressed afterwards, the show will resume after 5 seconds.

3. Time Mode

01) Press the **A** button to activate Time mode.

02) Press and hold down the **A** button for 3 seconds to enter edition mode and adjust the following time parameters:

 Up/Down 

Year

 Up/Down 

Month

 Up/Down 

Day

 Up/Down 

Hour

 Up/Down 

Minutes

 Up/Down 

Seconds

 Up/Down 

12- or 24-hour Display Mode (not adjustable with the remote control)

03) Press the   buttons to adjust the values of the parameters from step 2.

04) To toggle between the parameters, keep pressing the **A** button.

4. Countdown Mode

01) Press the **B** button to activate Countdown mode.

02) Press and hold down the **B** button for 3 seconds to enter the countdown setup.

03) Press the numeric **0-9** buttons to set the starting point of the countdown.
For example, 0008 = 8 seconds.

04) Press the **B** button to confirm.

05) Press the  button to start/pause the countdown.

5. Text Mode

01) Press the **C** button to activate Text mode.

02) Press the **0-9** buttons to call up one of the previously created custom texts.

03) Press the **C** button again to activate a loop playback of all the saved texts in a sequence.

DMX Channels



20 channels

Channel 1 – Shutter

0-31	Laser off
32-255	Laser on

Channel 2 – Pattern progression

0-31	1 st form
32-63	2 nd form
64-95	3 rd form
96-127	4 th form
128-159	5 th form
160-191	6 th form
192-223	7 th form
224-255	8 th form

Channel 3 – Patterns  **Ch 2 and Ch 3 are connected to each other.** 
The full pattern chart, see page 31.

Choose your preferred pattern by adjusting the value of Channel 3. Subsequently, adjust the value of Channel 2 to gain access to secondary patterns.

Channel 4 – Color

0-7	Default colors
8-15	Blue
16-23	Green
24-31	Cyan
32-39	Red
40-47	Purple
48-55	Yellow
56-63	White
64-111	Color switch, from slow to fast
112-159	Color switch, from slow to fast
160-207	Color flow, from slow to fast
208-255	Strobe, from slow to fast

Channel 5 – Gradual pattern drawing

0	Off
1-127	Manual pattern drawing
128-255	Automatic pattern drawing, from slow to fast

Channel 6 – Zoom

0-127	Manual zoom out
128-169	Zoom out
170-209	Zoom in
210-255	Zoom in and zoom out

Channel 7 – Zoom speed

0-255	Manual zoom speed adjustment, from fast to slow
-------	---

Channel 8 – Y-axis rotation

0-127	Manual Y-axis rotation adjustment
128-191	Clockwise rotation
192-255	Counterclockwise rotation

Channel 9 – Y-axis rotation speed

0-255 Y-axis rotation speed, from fast to slow

Channel 10 – X-axis rotation

0-127 Manual X-axis rotation adjustment

128-191 Clockwise rotation

192-255 Counterclockwise rotation

Channel 11 – X-axis rotation speed

0-255 X-axis rotation speed, from fast to slow

Channel 12 – Z-axis rotation

0-127 Manual Z-axis rotation adjustment

128-191 Clockwise rotation

192-255 Counterclockwise rotation

Channel 13 – Z-axis rotation speed

0-255 Z-axis rotation speed, from fast to slow

Channel 14 – Horizontal movement

0-127 Manual adjustment

128-191 From left to right movement

192-255 From right to left movement

Channel 15 – Horizontal movement speed

0-255 Horizontal speed, from fast to slow

Channel 16 – Vertical movement

0-127 Manual adjustment

128-191 Up to down movement

192-255 Down to up movement

Channel 17 – Vertical movement speed

0-255 Vertical speed, from fast to slow

Channel 18 – Wave effect

0-255 Wave effect range adjustment

Channel 19 – Wave frequency0-31 1st form32-63 2nd form64-95 3rd form96-127 4th form128-159 5th form160-191 6th form192-223 7th form224-255 8th form**Channel 20 – Wave speed**

0-127 Wave position

128-255 Wave effect speed, from slow to fast

Patterns

Channel 3	Channel 2	Channel 2	Channel 2	Channel 2	Channel 2	Channel 2	Channel 2	Channel 2
	0-31	32-63	64-95	96-127	128-159	160-191	192-223	224-255
						Symbols	Digits and letters	Words
0-15							0	Crazy
16-31							1	Dance
32-47						Boy	2	Good
48-63						Girl	3	Happy
64-79						Thumb up	4	Love
80-95						Hand	5	Music
96-111						V sign	6	Party
112-127						Yin Yang	7	Ready
128-143						Pigeon	8	Start
144-159						Heart	9	Stop
160-175						Clock	A	Thank You
176-191						Smiley	B	Welcome
192-207						Rose	C	Win
208-223							D	Disco
224-239							?	World Cup
240-255							!	Christmas

Maintenance

The Showtec Galactic requires almost no maintenance. However, you should keep the unit clean. Otherwise, the fixture's light-output will be significantly reduced.

Disconnect the mains power supply and then wipe the cover with a damp cloth. Wipe the front glass panel clean with glass cleaner and a soft cloth. Do not use alcohol or solvents. The front glass panel will require weekly cleaning, as smoke-fluid tends to build up residues, reducing the light-output very quickly. Do not immerse in liquid.

Keep connections clean. Disconnect electric power, and then wipe the DMX and audio connections with a damp cloth. Make sure connections are thoroughly dry before linking equipment or supplying electric power.

The operator has to make sure that safety-relating and machine-technical installations are to be inspected by an expert after every year in the course of an acceptance test.

The operator has to make sure that safety-relating and machine-technical installations are to be inspected by a skilled person once a year.

The following points have to be considered during the inspection:

- 01) All screws used for installing the device or parts of the device have to be tightly connected and must not be corroded.
- 02) There may not be any deformations on housings, fixations and installation spots.
- 03) Mechanically moving parts like axles, eyes and others may not show any traces of wearing.
- 04) The electric power supply cables must not show any damages or material fatigue.

Replacing the Fuse

Power surges, short-circuit or inappropriate electrical power supply may cause a fuse to burn out. If the fuse burns out, the product will not function whatsoever. If this happens, follow the directions below.

- 01) Unplug the unit from electric power source.
- 02) Insert a screwdriver into the slot in the fuse cover. Gently pry up the fuse cover. The fuse will come out.
- 03) Remove the used fuse. If brown or unclear, it is burned out.
- 04) Insert the replacement fuse into the holder where the old fuse was. Reinsert the fuse cover. Be sure to use a fuse of the same type and specification. See the product specification label for details.

Troubleshooting

This troubleshooting guide is meant to help solve simple problems.

If a problem occurs, carry out the steps below in sequence until a solution is found. Once the unit operates properly, do not carry out following steps.

No Light

If the light effect does not operate properly, refer servicing to a technician.

Response: Suspect three potential problem areas as: the power supply, the laser, the fuse.

- 01) Power supply. Check that the unit is plugged into an appropriate power supply.
- 02) The laser. Return the Galactic to your Showtec dealer.
- 03) The fuse. Replace the fuse. See page 32 for replacing the fuse.
- 04) If all of the above appears to be O.K., plug the unit in again.
- 05) If you are unable to determine the cause of the problem, do not open the Galactic, as this may damage the unit and the warranty will become void.
- 06) Return the device to your Showtec dealer.

No Response to DMX

Response: Suspect the DMX cable or connectors, a controller malfunction, a light effect DMX card malfunction.

- 01) Check the DMX setting. Make sure that DMX addresses are correct.
- 02) Check the DMX cable: Unplug the unit; change the DMX cable; then reconnect to electrical power. Try your DMX control again.
- 03) Determine whether the controller or light effect is at fault. Does the controller operate properly with other DMX products? If not, take the controller in for repair. If so, take the DMX cable and the light effect to a qualified technician.

Problem	Probable cause(s)	Remedy
One or more fixtures do not function at all	No power to the fixture.	<ul style="list-style-type: none"> • Check that power is switched on and cables are plugged in.
	Primary fuse blown..	<ul style="list-style-type: none"> • Replace fuse.
Fixtures reset correctly, but all respond erratically or not at all to the controller.	The controller is not connected.	<ul style="list-style-type: none"> • Connect controller.
	3-pin XLR Out of the controller does not match XLR Out of the first fixture on the link (i.e. signal is reversed).	<ul style="list-style-type: none"> • Install a phase reversing cable between the controller and the first fixture on the link.
Fixtures reset correctly, but some respond erratically or not at all to the controller.	Poor data quality	<ul style="list-style-type: none"> • Check data quality. If much lower than 100 percent, the problem may be a bad data link connection, poor quality or broken cables, missing termination plug, or a defective fixture disturbing the link.
	Bad data link connection	<ul style="list-style-type: none"> • Inspect connections and cables. Correct poor connections. Repair or replace damaged cables.
	Data link not terminated with 120 Ohm termination plug.	<ul style="list-style-type: none"> • Insert termination plug in output jack of the last fixture on the link.
	Incorrect addressing of the fixtures.	<ul style="list-style-type: none"> • Check address setting.
	One of the fixtures is defective and disturbs data transmission on the link.	<ul style="list-style-type: none"> • Bypass one fixture at a time until normal operation is regained: unplug both connectors and connect them directly together. • Have the defective fixture serviced by a qualified technician.
	3-pin XLR Out on the fixtures does not match (pins 2 and 3 reversed).	<ul style="list-style-type: none"> • Install a phase-reversing cable between the fixtures or swap pin 2 and 3 in the fixture, that behaves erratically.
Shutter closes suddenly	The laser diode has lost its index position and the fixture is resetting the effect.	<ul style="list-style-type: none"> • Contact a technician for servicing the problem persists.
No light or laser cuts out intermittently	Fixture is too hot.	<ul style="list-style-type: none"> • Allow fixture to cool. • Make sure air vents at control panel and front lens are not blocked. • Turn up the air conditioning .
	Laser damaged	<ul style="list-style-type: none"> • Disconnect fixture and return to your dealer.
	The power supply settings do not match local AC voltage and frequency.	<ul style="list-style-type: none"> • Disconnect fixture. Check settings and correct if necessary.

Product Specifications

Model:	Galactic TXT
Input Voltage:	AC 100-240V, 60/50Hz
Continuous Power:	12 Watt
Fuse:	T1A/250V
Dimensions:	225 x 185 x 185 mm (LxWxH)
Weight:	2 kg
Operation and Programming	
Signal pin OUT:	pin 1 earth, pin 2 (-), pin 3 (+)
Set Up and Addressing:	Red LED display for all settings
DMX Channels:	20 channels
Signal input:	3-pin DMX signal connector IN
Signal output:	3-pin DMX signal connector OUT
Electro-mechanical effects	
Laser Class:	3B
Laser Power:	215mW (105mW 650nm Red, 40mW 532nm Green, 70mW 450nm Blue)
Cooling:	Cooling fans and TE Cooling
Beam diameter:	<20mm at aperture
Pulse Data, All Pulses:	<4Hz (>0.25 sec)
Divergence (each beam):	<2 mrad;
Divergence (total light):	<160 degrees
Safety Features:	Key switch, Interlock
DMX-control:	Via standard DMX-controller
Control Modes:	Auto, Sound, Text, Time, Countdown, DMX, Master/Slave
Housing:	Black Metal & Flame-retardant plastic
Connections:	Dedicated IEC Power & Data connector
Laser Safety:	EN/IEC 60825-1 Ed 2, 2007-03
Max. ambient temperature t_a :	40°C
Minimum distance:	
Minimum distance from flammable surfaces:	0.5m
Minimum distance to lighted object:	1m

Design and product specifications are subject to change without prior notice.



Website: www.Showtec.info

Email: service@highlite.nl

Dimensions

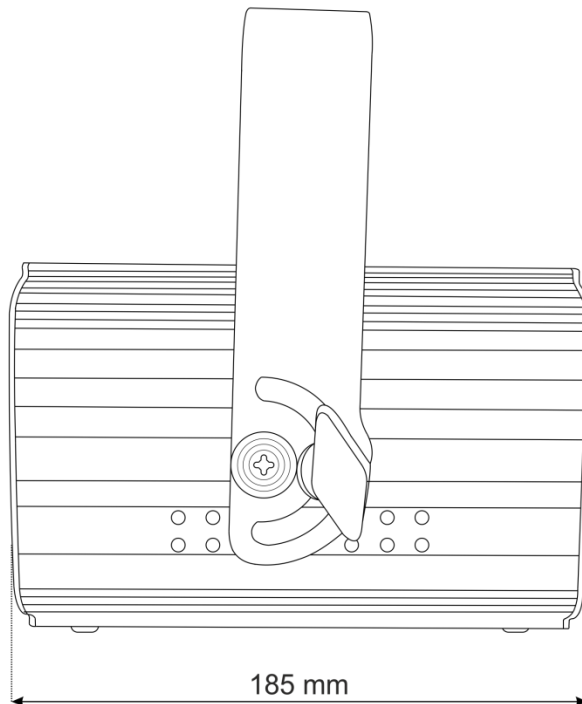
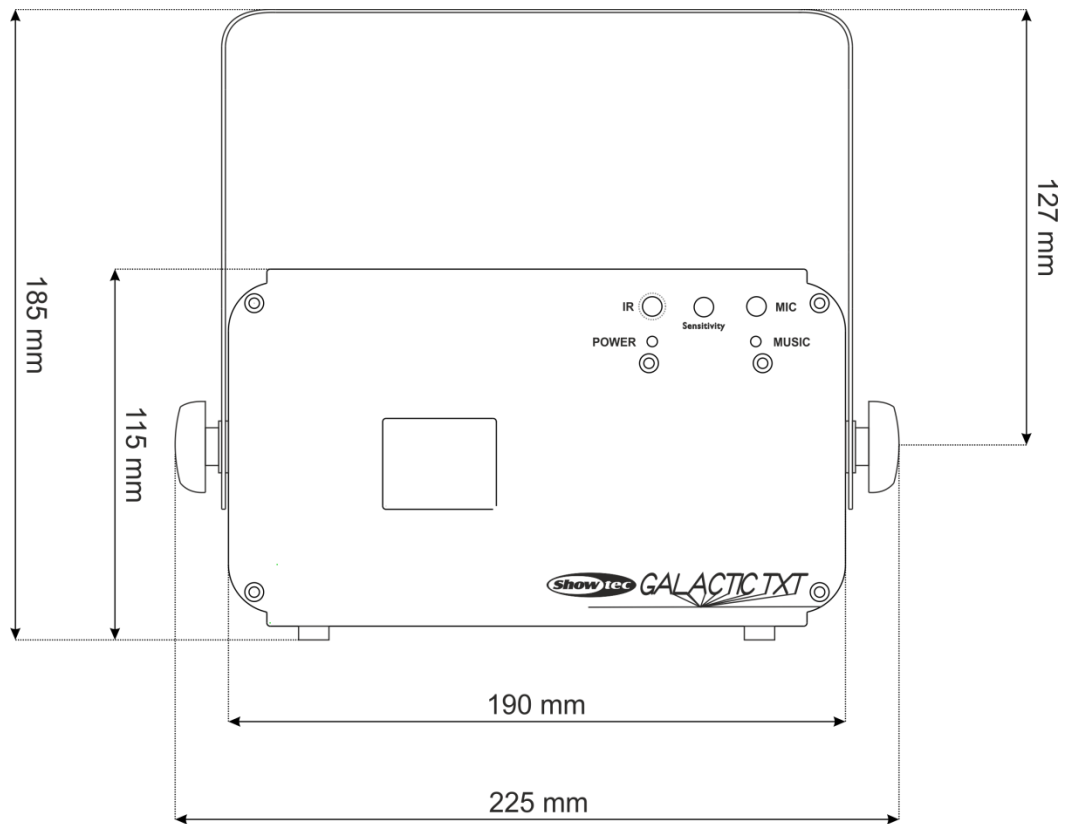



©2015 Showtec